

1

2

3

4

5

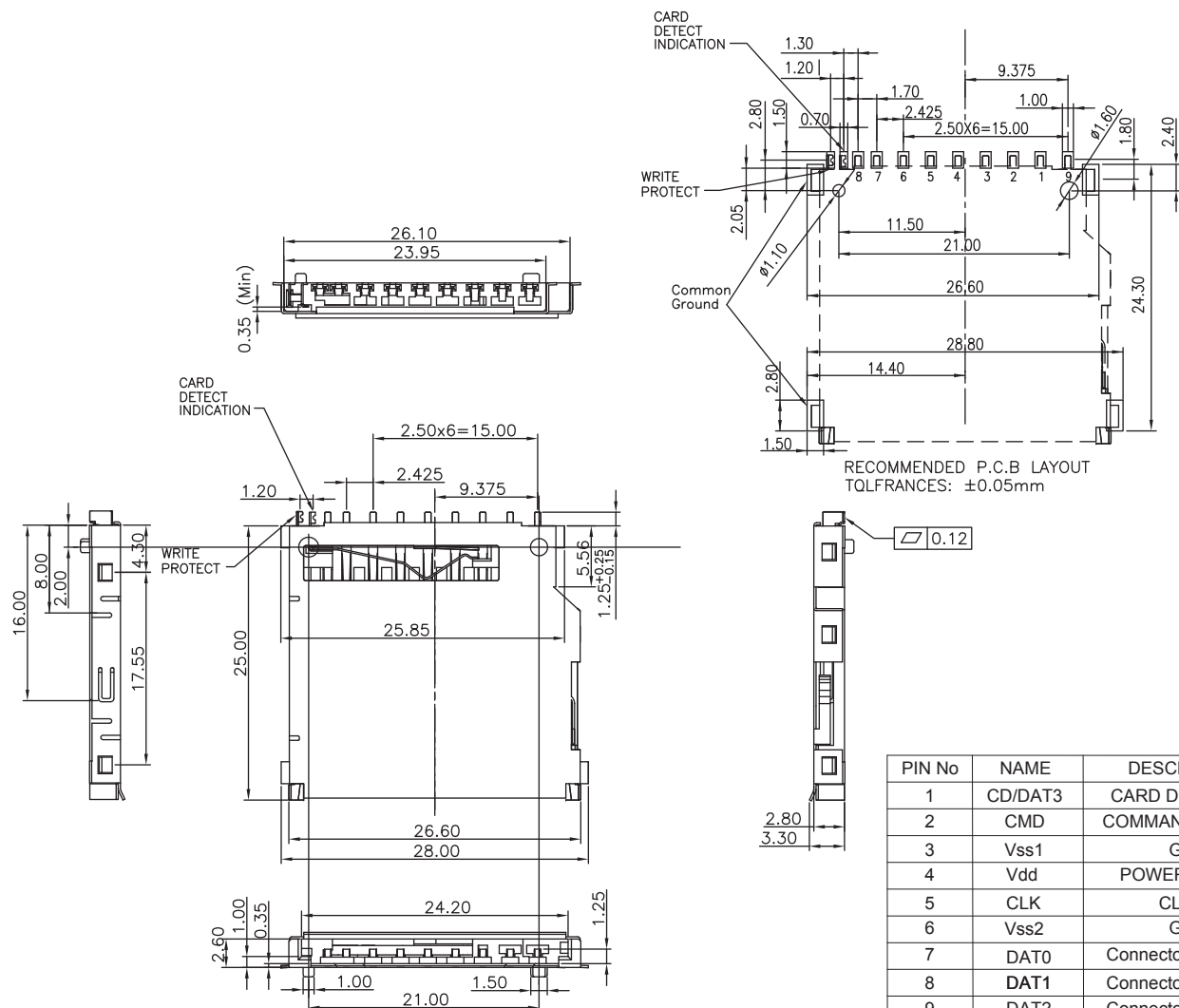

TECHNICAL CHARACTERISTICS

MATERIAL
 INSULATOR: LCP
 FLAMABILITY RATING: UL94-V0
 COLOR: BLACK
 CONTACT MATERIAL: COPPER ALLOY
 CONTACT TYPE: STAMPED
 CONTACT PLATING: SELECTIVE GOLD
 SHIELDING: COPPER ALLOY
 SHIELDING PLATING: NICKEL
 QUALITY CLASS: 10000 MATING CYCLES

ENVIRONMENTAL
 OPERATING TEMPERATURE: -25 UP TO 85°C
 COMPLIANCE: LEAD FREE AND ROHS

ELECTRICAL
 CURRENT RATING: 0.5A
 WORKING VOLTAGE: 100VAC
 INSULATOR RESISTANCE: >1000 MOHM
 DIELECTRIC WITHSTANDING VOLTAGE: 500VAC/MN
 CONTACT RESISTANCE: 100 mOHM MAX

SOLDERING
 REFLOW PROCESS ONLY

PACKAGING
 TAPE & REEL

PIN No	NAME	DESCRIPTION
1	CD/DAT3	CARD DETECTION
2	CMD	COMMAND/ANSWER
3	Vss1	GND
4	Vdd	POWER SUPPLY
5	CLK	CLOCK
6	Vss2	GND
7	DAT0	Connector data line 0
8	DAT1	Connector data line 1
9	DAT2	Connector data line 2

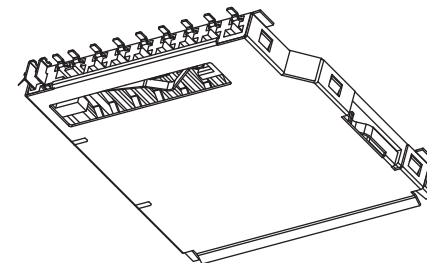

RoHS Compliant

REV	DATE	FILE	BY
G	23-JAN-13	LAYOUT DIM ADD	QL
F	16-MAY-12	LAYOUT	GG
E	27-MAR-12	PINNING	QL
D	07-MAR-12	PAGE 2 SWITCH	GG
C	22-FEB-12	PAGE 2	GG
B	16-FEB-12	TKP	GG
A	11-AUG-31	PDF	GG

PROJECTION:

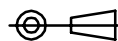

APPROVAL: RJ

GENERAL TOLERANCE

.X = +/- 0.2

.XX = +/- 0.15



DESCRIPTION: SD Card Connector - Push & Pull - With Card Detection
9 pins

WERI PART NO: 693 063 010 911

SIZE

A4

1

2

3

4

5

A

B

C

D

Contact OFF

Contact ON / Lock OFF

Contact ON / Lock ON



DETAIL L

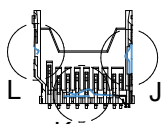

DETAIL K



DETAIL J

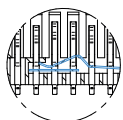

DETAIL K

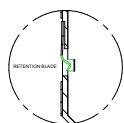

DETAIL N

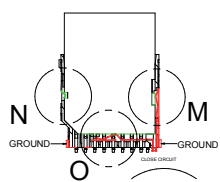

DETAIL O

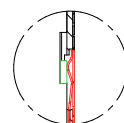

DETAIL M

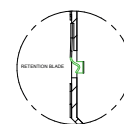

DETAIL Q

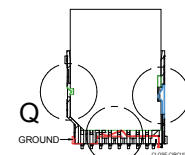

DETAIL R

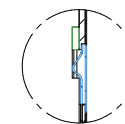

DETAIL P

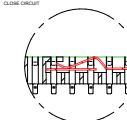

DETAIL R

Card detection switch		Write protection switch		
Card removed	Card inserted	Card removed	Card inserted	
			Write Protect	Write enable
OPEN	CLOSE	OPEN	OPEN	CLOSE

RoHS Compliant

PROJECTION:

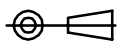

GENERAL TOLERANCE

.X = +/- 0.2

.XX = +/- 0.15



APPROVAL: RJ

UNIT: MM

SCALE:

SHEET: 2/3

DRAW: VICKY

DESCRIPTION: SD Card Connector - Push & Pull - With Card Detection
9 pins

WERI PART NO: 693 063 010 911

SIZE

A4

REV	DATE	FILE	BY
-----	------	------	----

1

2

3

4

5

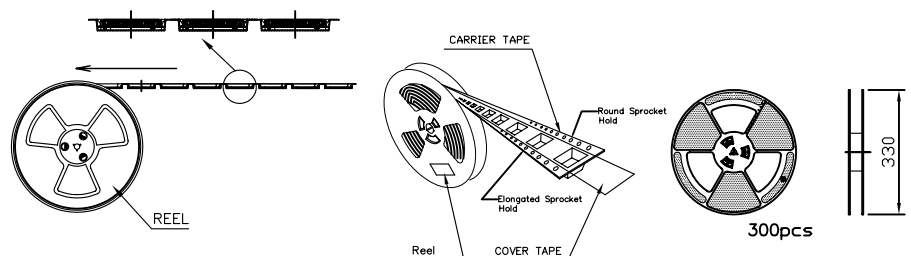
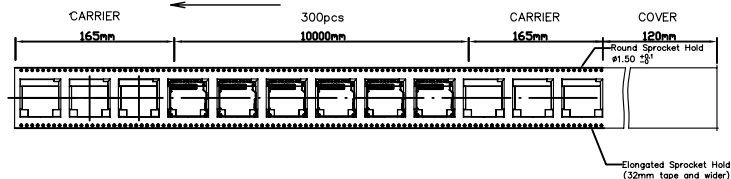
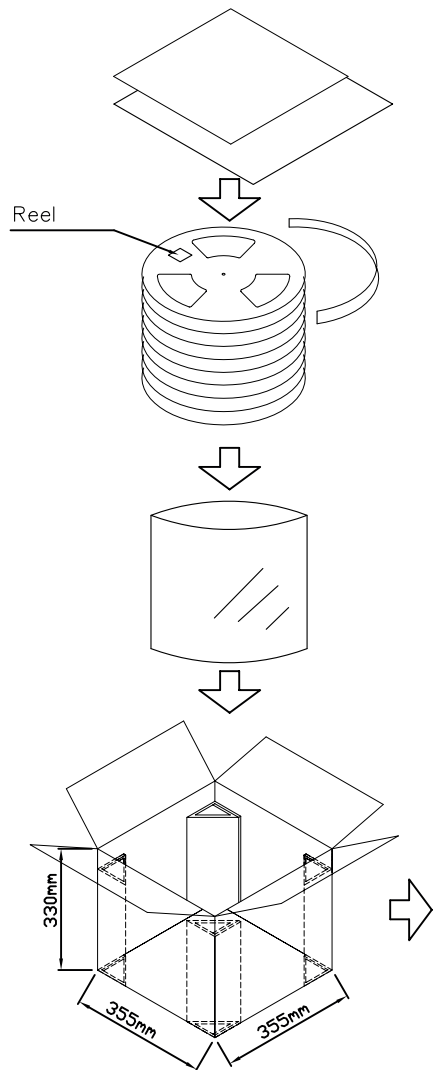

NOTES

1. MATERIALS: PS
2. PACKING: TAPE REEL(300PCS/R,1800PCS/CTN)
3. SONY SS-00259 or RoHS

All Material in According With The Rohs Environment Related Substances List Controlled.

RoHS Compliant				PROJECTION:	GENERAL TOLERANCE		DESCRIPTION: SD Card Connector - Push & Pull - With Card Detection 9 pins	SIZE A4
					$.X = \pm 0.2$ $.XX = \pm 0.15$			
				APPROVAL: RJ	UNIT: MM	WERI PART NO: 693 063 010 911		
					SCALE:			
					SHEET: 3/3			
REV	DATE	FILE	BY		DRAW: VICKY			

A

B

C

D