

High Intensity LED, \varnothing 5 mm 30 ° Untinted Non-Diffused

Description

The TLC.52.. series is a clear, non diffused 5 mm LED for high end applications where supreme luminous intensity required.

These lamps with clear untinted plastic case utilize the highly developed ultrabright AllnGaP and InGaN technologies.

The lens and the viewing angle is optimized to achieve best performance of light output and visibility.

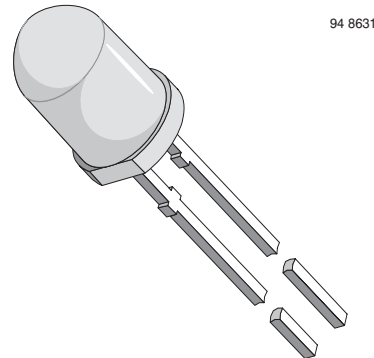

Features

- Untinted non diffused lens
- Utilizing ultrabright AllnGaP and InGaN technology
- High luminous intensity
- High operating temperature:
T_j (chip junction temperature)
up to 125 °C for AllnGaP devices
- Luminous intensity and color categorized for each packing unit
- ESD-withstand voltage:
2 kV acc. to MIL STD 883 D, Method 3015.7
for AllnGaP, 1 kV for InGaN

Applications

- Interior and exterior lighting
- Outdoor LED panels
- Instrumentation and front panel indicators
- Central high mounted stop lights (CHMSL)
for motor vehicles
- Replaces incandescent lamps
- Traffic signals
- Light guide design

Parts Table

Part	Color, Luminous Intensity	Angle of Half Intensity ($\pm\phi$)	Technology
TLCR5200	Red, I _v > 1350 mcd	15	AllnGaP on GaAs
TLCY5200	Yellow, I _v > 1350 mcd	15	AllnGaP on GaAs
TLCTG5200	True green, I _v > 750 mcd	15	InGaN on SiC
TLCB5200	Blue, I _v > 240 mcd	15	InGaN on SiC

Absolute Maximum Ratings

$T_{amb} = 25\text{ }^{\circ}\text{C}$, unless otherwise specified

TLCR5200 , TLCY5200

Parameter	Test condition	Symbol	Value	Unit
Reverse voltage		V_R	5	V
DC forward current	$T_{amb} \leq 85\text{ }^{\circ}\text{C}$	I_F	50	mA
Surge forward current	$t_p \leq 10\text{ }\mu\text{s}$	I_{FSM}	1	A
Power dissipation	$T_{amb} \leq 85\text{ }^{\circ}\text{C}$	P_V	135	mW
Junction temperature		T_j	125	$^{\circ}\text{C}$
Operating temperature range		T_{amb}	- 40 to + 100	$^{\circ}\text{C}$
Storage temperature range		T_{stg}	- 40 to + 100	$^{\circ}\text{C}$
Soldering temperature	$t \leq 5\text{ s}$, 2 mm from body	T_{sd}	260	$^{\circ}\text{C}$
Thermal resistance junction/ ambient		R_{thJA}	300	K/W

TLCTG5200 , TLCB5200

Parameter	Test condition	Symbol	Value	Unit
Reverse voltage		V_R	5	V
DC forward current	$T_{amb} \leq 60\text{ }^{\circ}\text{C}$	I_F	30	mA
Surge forward current	$t_p \leq 10\text{ }\mu\text{s}$	I_{FSM}	0.1	A
Power dissipation	$T_{amb} \leq 60\text{ }^{\circ}\text{C}$	P_V	135	mW
Junction temperature		T_j	100	$^{\circ}\text{C}$
Operating temperature range		T_{amb}	- 40 to + 100	$^{\circ}\text{C}$
Storage temperature range		T_{stg}	- 40 to + 100	$^{\circ}\text{C}$
Soldering temperature	$t \leq 5\text{ s}$, 2 mm from body	T_{sd}	260	$^{\circ}\text{C}$
Thermal resistance junction/ ambient		R_{thJA}	300	K/W

Optical and Electrical Characteristics

$T_{amb} = 25\text{ }^{\circ}\text{C}$, unless otherwise specified

Red

TLCR5200

Parameter	Test condition	Part	Symbol	Min	Typ.	Max	Unit
Luminous intensity ¹⁾	$I_F = 50\text{ mA}$	TLCR5200	I_V	1350	4000		mcd
Dominant wavelength	$I_F = 50\text{ mA}$		λ_d	611	616	622	nm
Peak wavelength	$I_F = 50\text{ mA}$		λ_p		622		nm
Spectral bandwidth at 50 % $I_{rel\ max}$	$I_F = 50\text{ mA}$		$\Delta\lambda$		18		nm
Angle of half intensity	$I_F = 50\text{ mA}$		ϕ		± 15		deg
Forward voltage	$I_F = 50\text{ mA}$		V_F		2.1	2.7	V
Reverse voltage	$I_R = 10\text{ }\mu\text{A}$		V_R	5			V
Temperature coefficient of V_F	$I_F = 50\text{ mA}$		TC_{VF}		- 3.5		mV/K
Temperature coefficient of λ_d	$I_F = 50\text{ mA}$		$TC_{\lambda d}$		0.05		nm/K

¹⁾ in one Packing Unit $I_{V\ Max.}/I_{V\ Min.} \leq 2.0$

Yellow
TLCY5200

Parameter	Test condition	Part	Symbol	Min	Typ.	Max	Unit
Luminous intensity ¹⁾	$I_F = 50 \text{ mA}$	TLCY5200	I_V	1350	4000		mcd
Dominant wavelength	$I_F = 50 \text{ mA}$		λ_d	585	590	597	nm
Peak wavelength	$I_F = 50 \text{ mA}$		λ_p		593		nm
Spectral bandwidth at 50 % $I_{rel \text{ max}}$	$I_F = 50 \text{ mA}$		$\Delta\lambda$		17		nm
Angle of half intensity	$I_F = 50 \text{ mA}$		φ		± 15		deg
Forward voltage	$I_F = 50 \text{ mA}$		V_F		2.1	2.7	V
Reverse voltage	$I_R = 10 \mu\text{A}$		V_R	5			V
Temperature coefficient of V_F	$I_F = 50 \text{ mA}$		TC_{V_F}		- 3.5		mV/K
Temperature coefficient of λ_d	$I_F = 50 \text{ mA}$		TC_{λ_d}		0.1		nm/K

¹⁾ in one Packing Unit $I_{V_{Max}}/I_{V_{Min}} \leq 2.0$

True green
TLCTG5200

Parameter	Test condition	Part	Symbol	Min	Typ.	Max	Unit
Luminous intensity ¹⁾	$I_F = 30 \text{ mA}$	TLCTG5200	I_V	750	2000		mcd
Dominant wavelength	$I_F = 30 \text{ mA}$		λ_d	515	525	535	nm
Peak wavelength	$I_F = 30 \text{ mA}$		λ_p		520		nm
Spectral bandwidth at 50 % $I_{rel \text{ max}}$	$I_F = 30 \text{ mA}$		$\Delta\lambda$		37		nm
Angle of half intensity	$I_F = 30 \text{ mA}$		φ		± 15		deg
Forward voltage	$I_F = 30 \text{ mA}$		V_F		3.9	4.5	V
Reverse voltage	$I_R = 10 \mu\text{A}$		V_R	5			V
Temperature coefficient of V_F	$I_F = 30 \text{ mA}$		TC_{V_F}		- 4.5		mV/K
Temperature coefficient of λ_d	$I_F = 30 \text{ mA}$		TC_{λ_d}		0.02		nm/K

¹⁾ in one Packing Unit $I_{V_{Max}}/I_{V_{Min}} \leq 2.0$

Optical and Electrical Characteristics

$T_{amb} = 25 \text{ }^\circ\text{C}$, unless otherwise specified

Blue
TLCB5200

Parameter	Test condition	Part	Symbol	Min	Typ.	Max	Unit
Luminous intensity ¹⁾	$I_F = 30 \text{ mA}$	TLCB5200	I_V	240	700		mcd
Dominant wavelength	$I_F = 30 \text{ mA}$		λ_d	462	470	476	nm
Peak wavelength	$I_F = 30 \text{ mA}$		λ_p		464		nm
Spectral bandwidth at 50 % $I_{rel \text{ max}}$	$I_F = 50 \text{ mA}$		$\Delta\lambda$		25		nm
Angle of half intensity	$I_F = 30 \text{ mA}$		φ		± 15		deg
Forward voltage	$I_F = 30 \text{ mA}$		V_F		3.9	4.5	V
Reverse voltage	$I_R = 10 \mu\text{A}$		V_R	5			V
Temperature coefficient of V_F	$I_F = 30 \text{ mA}$		TC_{V_F}		- 5.0		mV/K
Temperature coefficient of λ_d	$I_F = 30 \text{ mA}$		TC_{λ_d}		0.02		nm/K

¹⁾ in one Packing Unit $I_{V_{Max}}/I_{V_{Min}} \leq 2.0$

Typical Characteristics ($T_{amb} = 25\text{ }^{\circ}\text{C}$ unless otherwise specified)

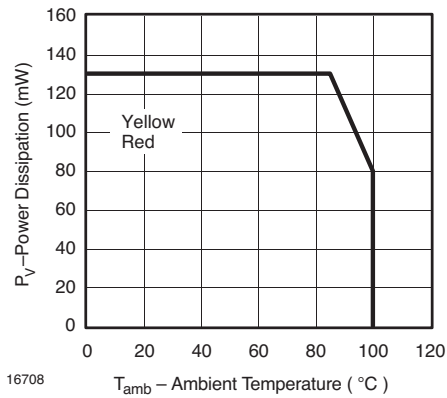

Figure 1. Power Dissipation vs. Ambient Temperature

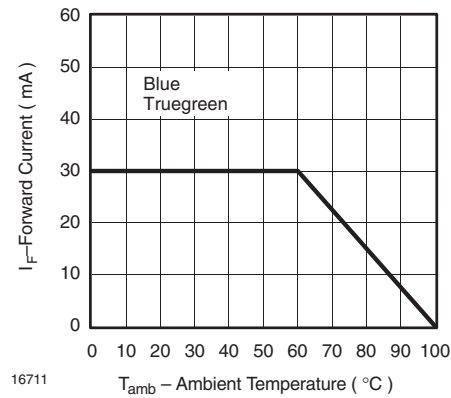

Figure 4. Forward Current vs. Ambient Temperature

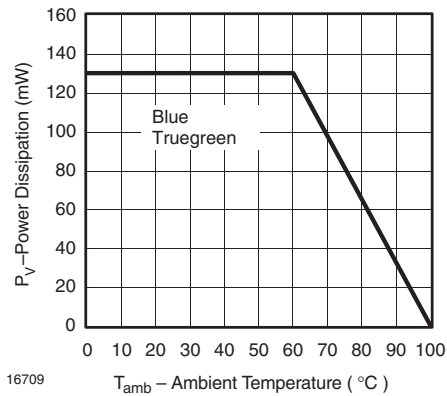

Figure 2. Power Dissipation vs. Ambient Temperature

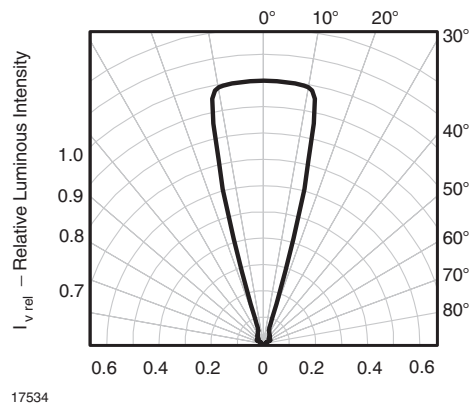

Figure 5. Rel. Luminous Intensity vs. Angular Displacement

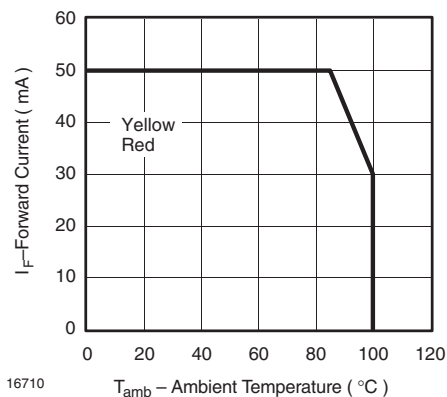

Figure 3. Forward Current vs. Ambient Temperature

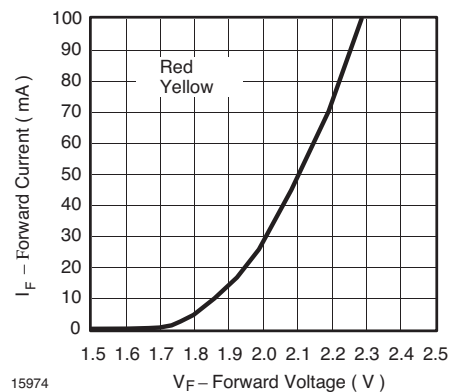

Figure 6. Forward Current vs. Forward Voltage

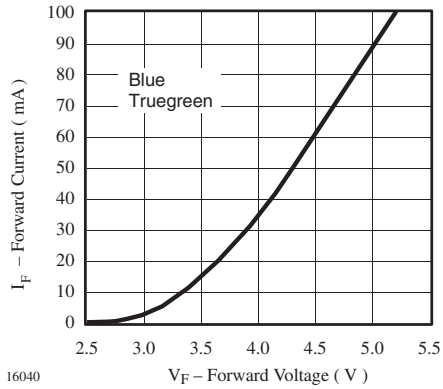

Figure 7. Forward Current vs. Forward Voltage

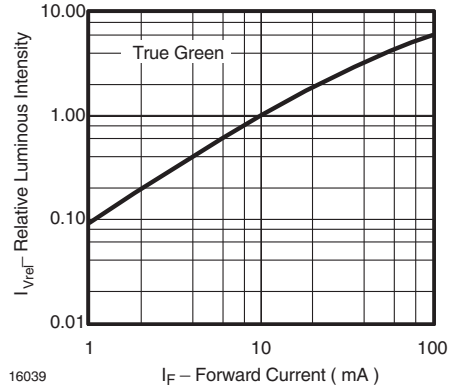

Figure 10. Relative Luminous Flux vs. Forward Current

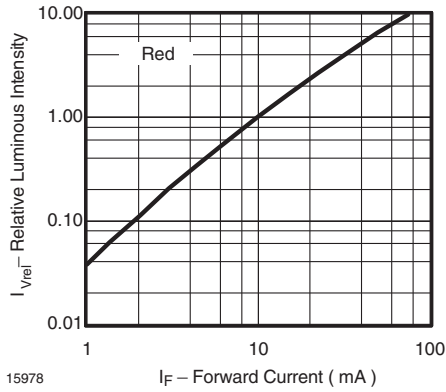

Figure 8. Relative Luminous Flux vs. Forward Current

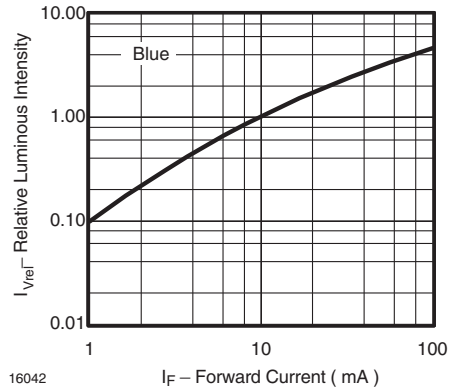

Figure 11. Relative Luminous Flux vs. Forward Current

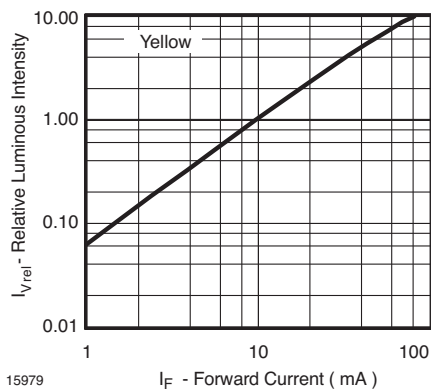

Figure 9. Relative Luminous Flux vs. Forward Current

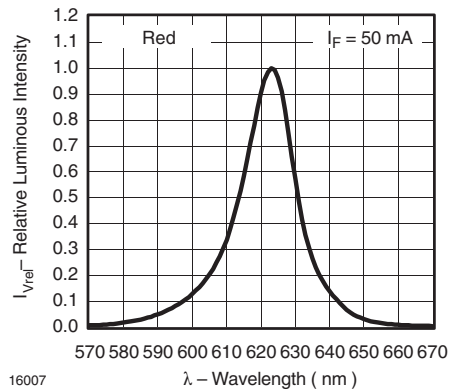

Figure 12. Relative Intensity vs. Wavelength

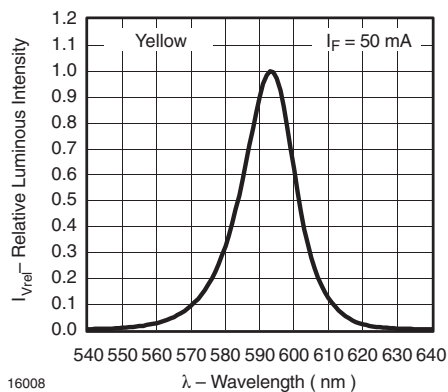

Figure 13. Relative Intensity vs. Wavelength

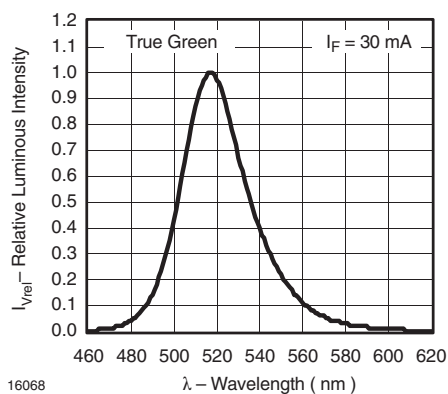

Figure 14. Relative Intensity vs. Wavelength

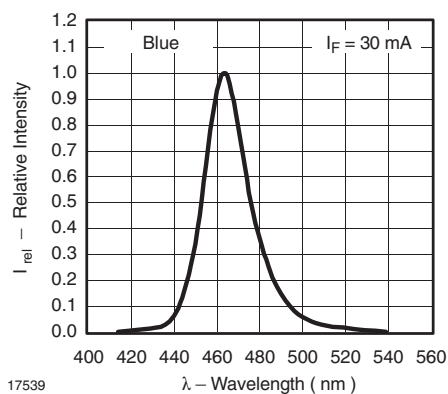
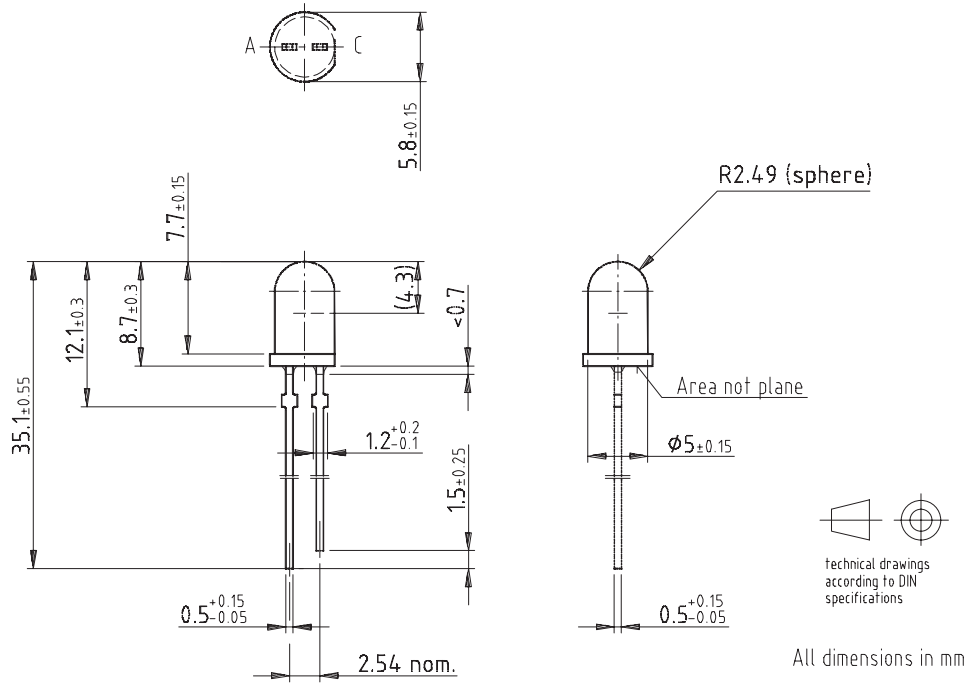

Figure 15. Relative Intensity vs. Wavelength

Package Dimensions in mm



Drawing-No.: 6.544-5258.07-4
 Issue: 3; 06.02.03

14339

Ozone Depleting Substances Policy Statement

It is the policy of **Vishay Semiconductor GmbH** to

1. Meet all present and future national and international statutory requirements.
2. Regularly and continuously improve the performance of our products, processes, distribution and operating systems with respect to their impact on the health and safety of our employees and the public, as well as their impact on the environment.

It is particular concern to control or eliminate releases of those substances into the atmosphere which are known as ozone depleting substances (ODSs).

The Montreal Protocol (1987) and its London Amendments (1990) intend to severely restrict the use of ODSs and forbid their use within the next ten years. Various national and international initiatives are pressing for an earlier ban on these substances.

Vishay Semiconductor GmbH has been able to use its policy of continuous improvements to eliminate the use of ODSs listed in the following documents.

1. Annex A, B and list of transitional substances of the Montreal Protocol and the London Amendments respectively
2. Class I and II ozone depleting substances in the Clean Air Act Amendments of 1990 by the Environmental Protection Agency (EPA) in the USA
3. Council Decision 88/540/EEC and 91/690/EEC Annex A, B and C (transitional substances) respectively.

Vishay Semiconductor GmbH can certify that our semiconductors are not manufactured with ozone depleting substances and do not contain such substances.

**We reserve the right to make changes to improve technical design
and may do so without further notice.**

Parameters can vary in different applications. All operating parameters must be validated for each customer application by the customer. Should the buyer use Vishay Semiconductors products for any unintended or unauthorized application, the buyer shall indemnify Vishay Semiconductors against all claims, costs, damages, and expenses, arising out of, directly or indirectly, any claim of personal damage, injury or death associated with such unintended or unauthorized use.

Vishay Semiconductor GmbH, P.O.B. 3535, D-74025 Heilbronn, Germany
Telephone: 49 (0)7131 67 2831, Fax number: 49 (0)7131 67 2423