

TNC ATTENUATOR
20 DB 3 GHZ 50W

R417.220.130
Series : ATTENUATOR

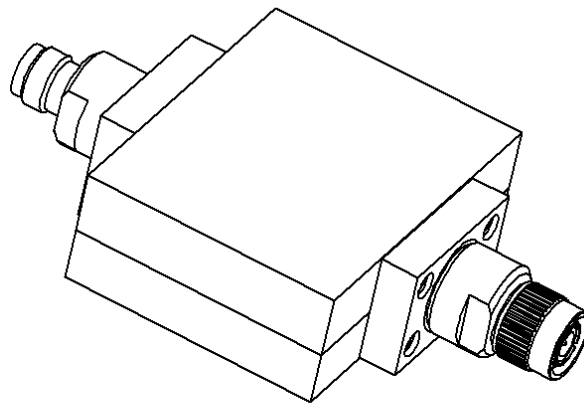

All dimensions are in mm.

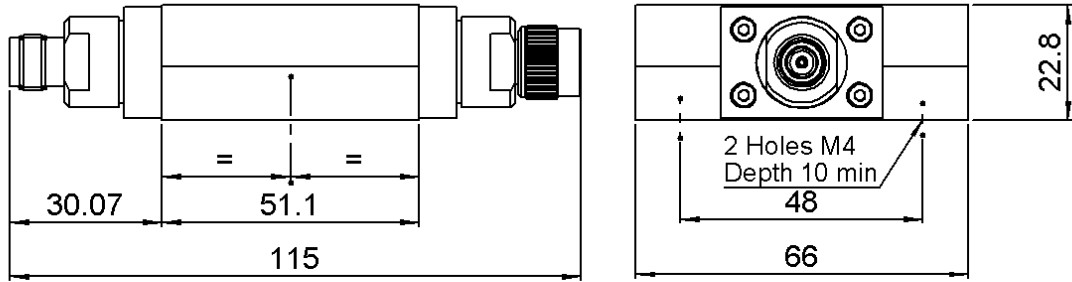

COMPONENTS	MATERIALS	PLATING(μm)
BODY	STAINLESS STEEL	PASSIVATION
MALE CENTER CONTACT	BERYLLIUM COPPER	GOLD 1.3 OVER NICKEL 2
FEMALE CENTER CONTACT	BERYLLIUM COPPER	GOLD 1.3 OVER NICKEL 2
OUTER CONTACT		
INSULATOR	PTFE	
GASKET	SILICONE RUBBER	
SUBSTRATE	ALUMINA	
RESISTOR	THICK FILM	
OTHERS PARTS	ALUMINIUM	BLACK PAINTING

Issue : 0842 A

In the effort to improve our products, we reserve the right to make changes judged to be necessary.



TNC ATTENUATOR
20 DB 3 GHZ 50W

R417.220.130
Series : ATTENUATOR

ELECTRICAL CHARACTERISTICS

Frequency (GHz)	DC - 1	1 - 2	2 - 3
V.S.W.R (≤)	1.10	1.25	1.35
Deviation(±dB)	2	2	2

Operating Frequency Range	DC - 3	GHz
Impedance	50	Ω
Nominal Attenuation	20	dB
Peak power at 25°C (1μs, 1%)	5000	W
Average power at 25°C		W (Free Air Cooled)
	50	W (Conduction Cooled)
For conduction cooling, a plate 500 cm ² x 3 mm(78 sq.in*1/8) min. is required		

MECHANICAL CHARACTERISTICS

Connectors	TNC	Male Female	MIL-C 39012
Weight	286,0100 g		

ENVIRONMENTAL CHARACTERISTICS

Operating temperature range	-55 /+125 °C
Storage temperature range	-55 /+125 °C



SPECIFICATION

OTHER CHARACTERISTICS

Issue : 0842 A

In the effort to improve our products, we reserve the right to make changes judged to be necessary.

