

Note: All part numbers
are RoHS Compliant.

Engineering Notes



Note: All part numbers are RoHS Compliant.

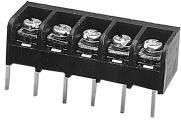
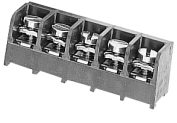



Table of Contents—Barrier Strips

| | |
|--|----------|
| Overview | 114-118 |
| (Barrier Strip Selector Chart) | 114, 115 |
| Tri-Barrier Strips | 119-138 |
| 0.250" Pitch | 120-123 |
| 0.325" Pitch | 124-127 |
| 0.375" Pitch | 128-135 |
| 0.4375" Pitch | 136-138 |
| Dual-Barrier Strips | 139-160 |
| 0.250" Pitch | 141-142 |
| 0.325" Pitch | 143-146 |
| 0.375" Pitch | 147-150 |
| 0.4375" Pitch | 151-154 |
| 0.375" Double Row, Panel Mount | 155-156 |
| 0.433" Double Row, Panel Mount | 157 |
| 0.437" Double Row, Panel Mount | 158 |
| 0.563" Double Row, Panel Mount | 160 |
| Sockets and Barrier Strips | 161-173 |
| 0.325" Pitch, Series USB3 Socket | 162 |
| 0.375" Pitch, Series RSB6B Socket | 163 |
| 0.325" Pitch, Series RSB3 Tri-Barrier | 164-166 |
| 0.325" Pitch, Series SSB3 Dual-Barrier | 168-170 |
| 0.375" Pitch, Series RSB6 Tri-Barrier | 171-173 |
| Accessories | 174-179 |

Note: All part numbers are RoHS Compliant.

Barrier Strip Selector Chart

Tri-Barrier

| | | | | | | | | |
|-------------------------|---|---|---|---|---|---|---|------------------|
| |  |  |  |  |  |  |  | |
| | 0.250" | 0.325" | 0.325" | 0.375" | 0.375" | 0.375" | 0.4375" | |
| Series | #3 | #4 | 1546927 | #6 | 1546833 | BC6 | MB6 | #8 |
| Pitch (in) | 0.250" | 0.325" | 0.325" | 0.375" | 0.375" | 0.375" | 0.375" | 0.4375" |
| Circuits | 2-32 | 2-30 | 2-8 | 2-30 | 2-8 | 2-16 | 4-40 | 2-26 |
| Max Current | 10A | 25A | 15A | 25A | 15A | 20A | 25A | 30A |
| Max Voltage | 300V | 300V | 300V | 600V | 300V | 300V | 300V | 600V |
| Wire Range (AWG) | 18-22 | 12-22 | 14-22 | 12-22 | 14-22 | 12-22 | 12-22 | 10-18 |
| Description | Molded to length | Molded to length | Molded to length | Molded to length | Molded to length, Modular | Molded to length | Double Level snapped to length | Molded to length |
| Page | 120-123 | 124-126 | 127 | 128-131 | 132 | 133-134 | 135 | 136-138 |

Dual-Barrier

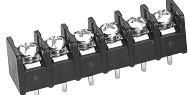
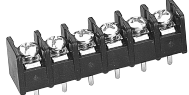
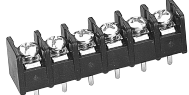
| | | | | | | |
|-------------------------|---|---|---|------------------|---------------------------------------|---------------|
| |  |  |  | | | |
| | .250" | 0.325" | 0.325" | 0.375" | 0.375" | 0.4375" |
| Series | 1546657 | 4DB | 1546734 | JC6 | NC6 | SSB7 |
| Pitch (in) | .250" | 0.325" | 0.325" | 0.375" | 0.375" | 0.4375" |
| Circuits | 2-30 | 2-30 | 2-16 | 2-16 | 2-30 | 2-27 |
| Max Current | 10A | 20A | 20A | 20A | 20A | 20A |
| Max Voltage | 300V | 150V/ 300V | 300V | 300V | 300V | 600V |
| Wire Range (AWG) | 16-30 | 14-22 | 12-22 | 12-22 | 12-22 | 12-26 |
| Description | Molded to length | Molded to length | High Rise, Molded to length | Molded to length | Low Profile version, Molded to length | Cut to length |
| Page | 141-142 | 143-144 | 145-146 | 147-148 | 149-150 | 151-154 |

Barrier Strip Selector Chart (Continued)

Double Row

| | 0.374" | 0.433" | 0.437" | 0.563" | |
|-------------------------|-------------------------------|-------------------------------|-------------------------------|-------------------------------|-------------------------------|
| Series | 1546306 1546307 | 1546481 1546477 | 1546670 1546671 | 1546310 1546311 | 1776544 1986158 |
| Pitch (in) | 0.374" | 0.433" | 0.437" | 0.563" | 0.563" |
| Circuits | 2-30 | 2-26 | 2-26 | 2-18 | 2-18 |
| Max Current | 20A | 25A | 25A | 30A | 30A |
| Max Voltage | 300V | 300V | 300V | 300V | 600V |
| Wire Range (AWG) | 12-22 | 14-22 | 14-22 | 10-22 | 10-22 |
| Description | Panel Mount, molded to length | Panel Mount, molded to length | Panel Mount, molded to length | Panel Mount, molded to length | Panel Mount, molded to length |
| Page | 156 | 157 | 158 | 159 | 160 |

Sockets and Barrier Strips



| | 0.325" | 0.325" | 0.325" | 0.375" | 0.375" |
|-------------------------|------------------------|---------------|---------------|-----------------|---------------|
| Series | USB | RSB3 | SSB3 | RSB6B | RSB6 |
| Pitch (in) | 0.325" | 0.325" | 0.325" | 0.375" | 0.375" |
| Circuits | 2-12 | 2-36 | 2-36 | 2-10 | 2-36 |
| Max Current | 10A | 15A | 15A | 10A | 20A |
| Max Voltage | 300V | 300V | 300V | 300V | 300V |
| Wire Range (AWG) | n/a | 14-26 | 14-26 | n/a | 12-26 |
| Description | For Series RSB3 & SSB3 | Cut to length | Cut to length | For Series RSB6 | Cut to length |
| Page | 162 | 164-166 | 168-170 | 163 | 171-173 |

Note: All part numbers are RoHS Compliant.

Catalog Number Code

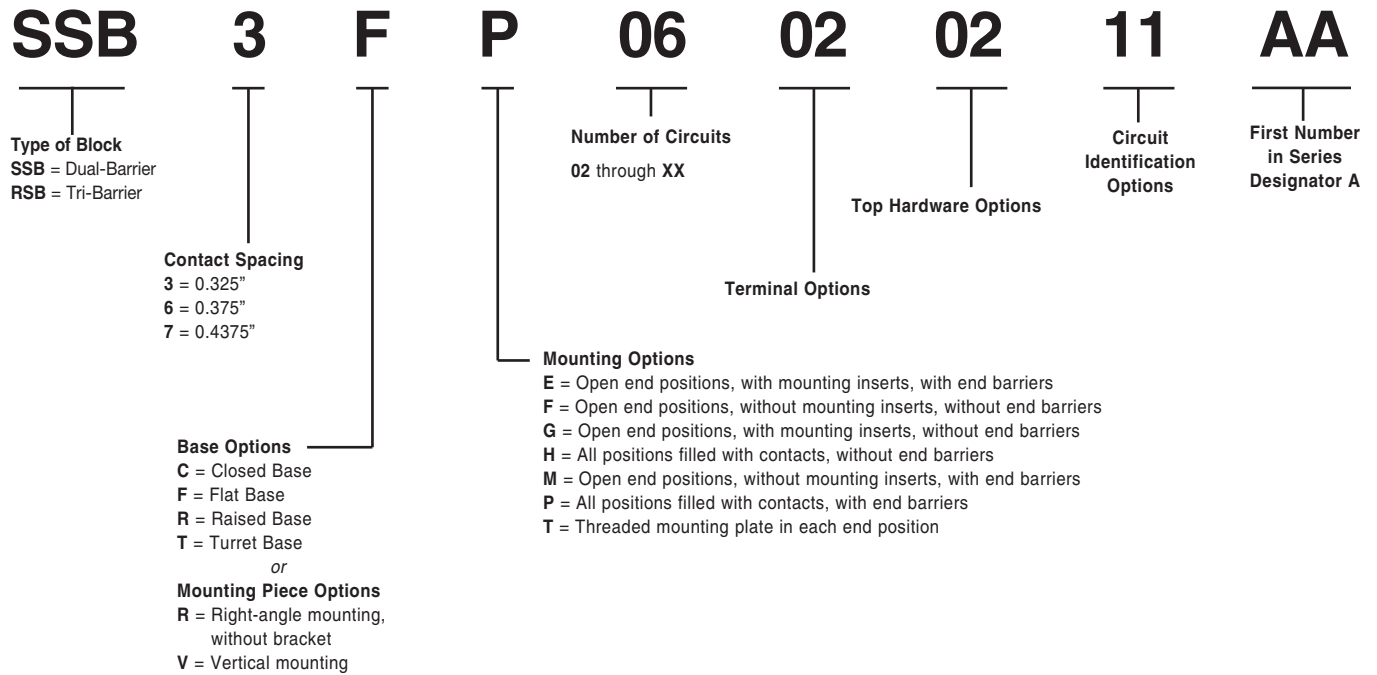

OPTIONAL TERMINAL IDENTIFICATION

Select the desired version from the list below and add the CODE NUMBER (11, 12, 15 or 16) to the end of the catalog number of the connector or header.

CODE
 11 = 1 2 3 4 . . .
 12 = . . . 4 3 2 1
 15 = . . . † 3 5 †
 16 = † 5 3 † . . .

*"First Number In Series" Designator**

- | | |
|-------|-------|
| A = 1 | F = 6 |
| B = 2 | G = 7 |
| C = 3 | H = 8 |
| D = 4 | J = 9 |
| E = 5 | K = 0 |

* Letters in this position designate the first number to be used in the consecutive sequence. Ex.: "A" would start the sequence with the number 1. "EK" would start the sequence with the number 50. "BKK" would start the series with 200. For non-sequential numbering and special characters, consult Technical Support.

Note: Some catalog number combinations are not valid. Check appropriate catalog pages before ordering. Catalog numbering code applies only to the catalog numbers on pages 125, 148-151, 164-169.

Note: All part numbers are RoHS Compliant.

Catalog Number Code (Continued)

6 PCV-04-XXX

Contact Spacing

- 3 = 0.250"
- 4 = 0.325"
- 6 = 0.375"
- 8 = 0.4375"

Suffix (if applicable)

Number of Circuits
02 through XX

Terminal Style

- DBL** = Double Printed Circuit Pin
- PCR** = Printed Circuit, Right Angle
- PCV** = Printed Circuit Pin, Vertical
- QCR** = Quick Connect Tab, Right Angle
- QCV** = Quick Connect Tab, Vertical
- STR** = Solder Turret, Right Angle
- STV** = Solder Turret, Vertical
- TBV** = Non Feed Thru
- WWR** = Solderless Wire Wrap, Right Angle
- WWV** = Solderless Wire Wrap, Vertical

Note: Some catalog number combinations are not valid. Check appropriate catalog pages before ordering. Catalog numbering code applies only to the catalog numbers on pages 119-124, 127-129, 134-136.

Barrier Strips – Overview

Two Types of Barrier Strips and a Line of Sockets:

Tri-Barrier

Three walls or barriers surround each terminal screw. The back wall safeguards field wiring.



Dual-Barrier

Two walls or barriers are molded on each side of the terminal screw.



Sockets

Mounted directly to the PC board, the Barrier Strip is plugged into the socket. The socket expedites field maintenance. (Below, a tri-barrier is about to be mounted in a socket.)



Wire Clamp Screws

The lower surface and edges of the clamping-plates are carefully designed to securely clamp the wire—even combinations of different wire sizes—without severing stranded wire. Extra care has been taken to produce these components without burrs on any critical clamping surface or edges.

Resilient Plastic Barriers

Flexible thermoplastic material for terminal blocks was an especially important feature at the time of its introduction, since many earlier blocks were molded of more rigid, brittle thermosetting plastic compounds.

Wire-Ready Raised Screws

Wire-ready raised screws are standard on BUCHANAN terminal blocks. No need to back off the screw first. Just insert the wire and drive down the screw. Wire installation time and effort are virtually cut in half.

Integral Standoffs

Standoffs help rid your PCB of any remaining corrosive agents during rinsing operations. Helps prevent trapped solutions in the immediate PC pin area. Significantly reduces the risk of postwave corrosion problems.

Gas-Tight Connections

The acid-tin plating on our terminals means more than just improved shelf-life and superior solderability. It is to provide the very basis for the heart of your wire connections.

Quality Plating

Tyco Electronics Corporation has been known for its plating, especially on the tin-plated components, and has maintained stringent plating specifications to provide a better performing, more reliable product. (Terminals meet or exceed Tyco Electronics Specification 109-11-1.)

UL Recognition and CSA Certification

Terminal blocks and interconnect components are Recognized under the Component Recognition Program of Underwriters Laboratories Inc. and Certified by Canadian Standards Association. (Consult individual sections of this catalog for status of a specific series.)

Typical Application

Pictured below is a PC board with barrier strips and sockets wave soldered to it.



Tri-Barrier Strips

Product Facts

- n Industrial controls and automation
- n Machine tools
- n HVAC/R
- n Power supplies
- n Security/Irrigation
- n Transformers

Design Advantages

- n Back barriers to safeguard field wiring
- n Fast wiring – backed-out wire-ready screws
- n Interrupted thread designed to prevent screws from falling out
- n Standoffs allow flux and solvents to drain during cleaning
- n Molded-to-length or cut-to-length versions available
- n Phil-slot screws are standard
- n RoHS compatible



Tri-Barrier blocks help contain stray or frayed wire ends. This helps prevent electrical shorts — not only between positions on the same block, but also between other components immediately adjacent to the block. With today’s high-density PCB designs, this has become an increasingly important feature.

Connector Index

| | |
|--|---------|
| 0.250" Pitch, Series #3 | 120-123 |
| 0.325" Pitch, Series #4 | 124-126 |
| 0.325" Pitch, with Attached Safety Cover | 127 |
| 0.375" Pitch, Series #6 | 128-135 |
| 0.375" Pitch, Modular with Cover | 132 |
| 0.375" Pitch, Series BC6, Panel Mount..... | 133,134 |
| 0.375" Pitch, Series MB6, Double Level | 135 |
| 0.4375" Pitch, Series #8 | 136-138 |

Note: All part numbers are RoHS Compliant.

.250" [6.35] Pitch, Series #3

3PCV-03-006 & 3PCV-10-006



Material & Finish

Housing Material—Polypropylene

Flammability—UL94V-0

Color—Black

Terminals—Bright acid tin over copper alloy

Screws—Steel, zinc plating with clear chromate coating. Wire clamping screws standard.

Mechanical Properties

Pitch (Terminal Spacing)—0.250" [6.35]

Recommended PCB Hole Dia.—1.8mm [.073"] Recommended Tightening Torque: 5.5 in.-lbs.

Electrical Properties

Ratings—UL Class C 10 Amps, 150V
UL Class D 10 Amps, 300V
CSA Type C 10 Amps, 150V
CSA Type D 10 Amps, 300V

Wire Range—18-22 AWG

Environmental Properties

Operating Temperature Range—105°C [221°F] max.

Circuit Identification—See page 179

Hardware Options

TC3—Safety cover, see page 174

J3—Jumper, see page 177



RIGHT ANGLE MOUNTING PANEL LAYOUT VERTICAL



RIGHT ANGLE PRINTED CIRCUIT LAYOUT CENTER

Note: All part numbers are RoHS Compliant.

.250" [6.35] Pitch, Series #3 (Continued)

Ordering Information

3 PCV - 04 - 006

- A** **Thread Size Spacing**
3 = #m3 on .250" Centers
- B** **Terminal Style**
 - PCV** = Printed Circuit Pin, Vertical
 - PCR** = Printed Circuit, Right Angle
 - STV** = Solder Turret, Vertical
 - STR** = Solder Turret, Right Angle
 - WWV** = Solderless Wire Wrap, Vertical
- C** **No. of Circuits (Not Positions)**
02 through 32
- D** **Modifier**
Use table below.

| Terminal Style | Modifier Phil-slot Head | Screw Style | Mounting Construction |
|----------------|-------------------------|-------------|---|
| PCV | 006 | Wire Clamp | No Mounting |
| | 008 | Wire Clamp |  |
| PCR | 006 | Wire Clamp | No Mounting |
| | 008 | Wire Clamp |  |
| STV WWV | 006 | Wire Clamp |  |
| | 008 | Wire Clamp | No Mounting |
| STR | 006 | Wire Clamp |  |
| | 008 | Wire Clamp |  |



Note: All part numbers are RoHS Compliant.

.250" [6.35] Pitch, Series #3 (Continued)

Printed Circuit Pin



Solder Turret



Wire Wrap

#3WWR not available



Note: All part numbers are RoHS Compliant.

.250" [6.35] Pitch, Series #3 (Continued)



| No. of Positions | Dim. A | No. of Positions | Dim. A |
|------------------|--------------|------------------|--------------|
| 2 | 0.25 [6.3] | 18 | 4.25 [107.9] |
| 3 | 0.50 [12.7] | 19 | 4.50 [114.3] |
| 4 | 0.75 [19.0] | 20 | 4.75 [120.6] |
| 5 | 1.00 [25.4] | 21 | 5.00 [127.0] |
| 6 | 1.25 [31.7] | 22 | 5.25 [133.3] |
| 7 | 1.50 [38.1] | 23 | 5.50 [139.7] |
| 8 | 1.75 [44.4] | 24 | 5.75 [146.0] |
| 9 | 2.00 [50.8] | 25 | 6.00 [152.4] |
| 10 | 2.25 [57.1] | 26 | 6.25 [158.8] |
| 11 | 2.50 [63.5] | 27 | 6.50 [165.1] |
| 12 | 2.75 [69.8] | 28 | 6.75 [171.5] |
| 13 | 3.00 [76.2] | 29 | 7.00 [177.8] |
| 14 | 3.25 [82.5] | 30 | 7.25 [184.2] |
| 15 | 3.50 [88.9] | 31 | 7.50 [190.5] |
| 16 | 3.75 [95.2] | 32 | 7.75 [196.9] |
| 17 | 4.00 [101.6] | | |

Barrier Strips

2



0.325" [8.26] Pitch, Series #4, Tri-Barrier

4PCV-06-006



Material & Finish

Housing Material—Polyamide

Flammability—UL94V-0

Color—Black

Terminals—Bright acid tin over copper alloy

Screws—#4-40 steel, zinc plating with clear chromate coating. Wire clamping screw and binding head screw available.

Mechanical Properties

Pitch (Terminal Spacing)—0.325" [8.255]

Recommended PCB Hole Dia.—1.8mm [.073"]

Recommended Tightening Torque—7 in.-lbs. max.

Electrical Properties

Ratings—UL Class C 20 Amps, 150V
UL Class D 10 Amps, 300V
CSA Type C 20 Amps, 150V
CSA Type D 10 Amps, 300V

Wire Range—12-22 AWG

Environmental Properties

Operating Temperature Range—105°C [221°F] max.

Circuit Identification—See page 179

Hardware Options

TC4—Safety cover, see page 174

8-1437649-0—Wire clamp screw, see page 178

8-1437649-0—Binding head screw, see page 178

J4—Jumper, see page 177

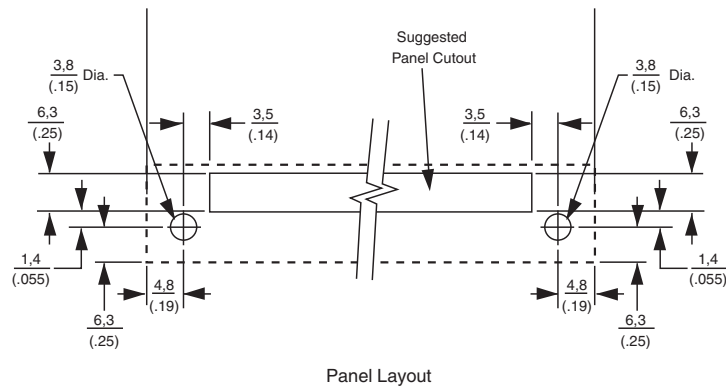

Note: All part numbers are RoHS Compliant.

0.325" [8.26] Pitch, Series #4, Tri-Barrier (Continued)

Ordering Information

4 PCV-04-006

A B C D

A Screw Size Spacing

4 = #4-40 on .325" Centers

C No. of Circuits (Not Positions)

02 through 30

B Terminal Style

DBL = Double Printed Circuit Pin

PCR = Printed Circuit, Right Angle

PCV = Printed Circuit Pin, Vertical

WWV = Solderless Wire Wrap, Vertical

D Modifiers

Use table below.

| Terminal Style | Modifier Phil-slot Head | Screw Style | Mounting Construction |
|----------------|-------------------------|-------------|---|
| DBL | 006 | Wire Clamp | No Mounting |
| PCV | 006 | Wire Clamp | No Mounting |
| | 008 | Wire Clamp |  |
| PCR | 006 | Wire Clamp | No Mounting |
| | 008 | Wire Clamp |  |
| WWV | 006 | Wire Clamp |  |
| | 008 | Wire Clamp | No Mounting |

Barrier Strips
2



Note: All part numbers are RoHS Compliant.

0.325" [8.26] Pitch, Series #4, Tri-Barrier (Continued)

Printed Circuit Pin



Wire Wrap

#4 WWR Not available



0.325" Pitch, Series #4, Tri-Barrier



| No. of Positions | Dim. A | No. of Positions | Dim. A |
|------------------|--------------|------------------|--------------|
| 2 | (0.325) 8,2 | 17 | (5.20) 132,1 |
| 3 | (0.65) 16,5 | 18 | (5.52) 140,3 |
| 4 | (0.97) 24,7 | 19 | (5.85) 148,6 |
| 5 | (1.30) 33,0 | 20 | (6.17) 156,8 |
| 6 | (1.62) 41,3 | 21 | (6.50) 165,1 |
| 7 | (1.95) 49,5 | 22 | (6.82) 173,3 |
| 8 | (2.27) 57,8 | 23 | (7.15) 181,6 |
| 9 | (2.60) 66,0 | 24 | (7.47) 189,9 |
| 10 | (2.92) 74,3 | 25 | (7.80) 198,1 |
| 11 | (3.25) 82,5 | 26 | (8.13) 206,4 |
| 12 | (3.57) 90,8 | 27 | (8.45) 214,6 |
| 13 | (3.90) 99,1 | 28 | (8.78) 222,9 |
| 14 | (4.22) 107,3 | 29 | (9.10) 231,1 |
| 15 | (4.55) 115,6 | 30 | (9.43) 239,4 |
| 16 | (4.87) 123,8 | | |



Tri-Barrier Strips with Attached Safety Covers, .325" [8.26] Centerline

Product Facts

- ▢ Screwdriver access holes in cover allow for efficient wiring; cover may remain closed



Material & Finish

Insulator Body—UL 94V-0 Thermoplastic, black

Terminal—Brass, tin-plated

Mechanical Properties

Recommended screw tightening torque—12 in-lbs

Combination drive screws with #2 Phillips recess and standard slot

Electrical Properties

Current Rating—15 A

Voltage Rating—300 VAC/DC

Wire Range—22-14 AWG, Cu, Solid or Stranded

Environmental Properties

Operating Temperature—-40°C to +120°C [-104°F to +248°F]

Circuit Identification—See page 179

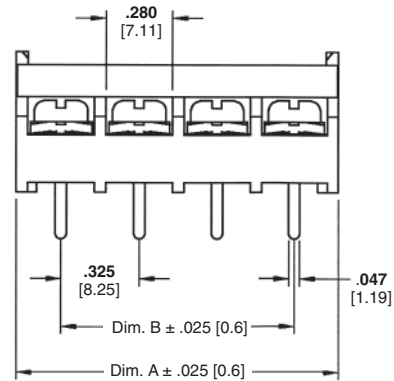
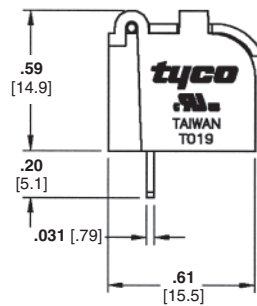
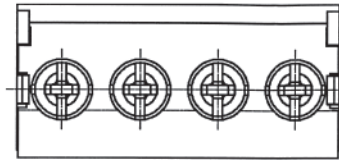

| No. of Position* | Dimensions | | Part Numbers |
|------------------|--------------|--------------|--------------|
| | A | B | |
| 2 | 0.697 [17.7] | 0.325 [8.3] | 1546927-2 |
| 3 | 1.022 [26.0] | 0.650 [16.5] | 1546927-3 |
| 4 | 1.347 [34.2] | 0.975 [24.8] | 1546927-4 |
| 5 | 1.672 [42.5] | 1.300 [33.0] | 1546927-5 |
| 6 | 1.997 [50.7] | 1.625 [41.3] | 1546927-6 |
| 7 | 2.322 [59.0] | 1.950 [49.5] | 1546927-7 |
| 8 | 2.647 [67.2] | 2.275 [57.8] | 1546927-8 |

*Contact Tyco Electronics for larger position sizes.
Note: Samples available in Sample Room.

0.375" [9.53] Pitch, Series #6, Tri-Barrier

6PCV-03-006 & 6PCV-06-006



Right Angle
Printed Circuit Board Layout

Material & Finish

Housing Material—Polyamide

Flammability—UL94V-0

Color—Black

Terminals—Bright acid tin over copper alloy

Screws—#6-32 steel, zinc plating with clear chromate coating. Wire clamping screws and binding head screws with undercut available.

Mechanical Properties

Pitch (Terminal Spacing)—0.375" [9.53]

Recommended PCB Hole Dia.—1.8mm [.073"]

Electrical Properties

Ratings—UL Class C 25 Amps, 300V
UL Class D 5 Amps, 600V
CSA Type C 25 Amps, 300V
CSA Type D 5 Amps, 600V

Wire Range—18-22 AWG

Environmental Properties

Operating Temperature Range—105°C [221°F] max.

Circuit Identification—See page 179

Hardware Options

QC6—Quick connects, see page 176

ST80—Single sided solder tabs, see page 176

J6—Jumpers, see page 177

TC6—Safety covers, see page 174

1437651-2—Wire clamp screw, steel, see page 178

1437651-5—Wire clamp screw, brass, see page 178

1437651-8—Binding head screw, steel, see page 178

L03—Binding head screw, stainless, see page 178



Right Angle
Mounting Panel Layout



Note: All part numbers are RoHS Compliant.

0.375" [9.53] Pitch, Series #6, Tri-Barrier (Continued)

6 PCV-04-006

A **B** **C** **D**

- A Screw Size Spacing**
6 = #6-32 on .375" Centers
- B Terminal Style**
 - DBL** = Double Printed Circuit Pin
 - PCR** = Printed Circuit, Right Angle
 - PCV** = Printed Circuit Pin, Vertical
 - STR** = Solder Turret, Right Angle
 - STV** = Solder Turret, Vertical
 - TBV** = Non Feed Thru
 - WWR** = Solderless Wire Wrap, Right Angle
 - WWV** = Solderless Wire Wrap, Vertical
- C No. of Circuits (Not positions)**
02 through 30
- D Modifiers**
Use table below.
-002=-006 except brass screw
-003=-007 except brass screw

| Terminal Style | Modifier Phil-slot Head | Screw Style | Mounting Construction |
|----------------|-------------------------|--------------|---|
| DBL | 006 | Wire Clamp | No Mounting |
| | 007 | Binding Head | |
| PCV | 006 | Wire Clamp | No Mounting |
| | 007 | Binding Head | |
| | 008 | Wire Clamp |  |
| | 009 | Binding Head | |
| PCR | 006 | Wire Clamp | No Mounting |
| | 007 | Binding Head | |
| | 008 | Wire Clamp |  |
| | 009 | Binding Head | |
| STV WWV | 006 | Wire Clamp |  |
| | 008 | Wire Clamp | |
| STR WWR | 006 | Wire Clamp |  |
| | 008 | Wire Clamp | |
| TBV | 006 | Wire Clamp |  |



Barrier Strips

2

Note: All part numbers are RoHS Compliant.

0.375" [9.53] Pitch, Series #6, Tri-Barrier (Continued)



| No. of Positions | Dim. A | No. of Positions | Dim. A |
|------------------|--------------|------------------|---------------|
| 2 | 0.375 [9.5] | 17 | 6.00 [152.4] |
| 3 | 0.75 [19.1] | 18 | 6.37 [161.9] |
| 4 | 1.12 [28.6] | 19 | 6.75 [171.4] |
| 5 | 1.50 [38.1] | 20 | 7.12 [181.9] |
| 6 | 1.87 [47.6] | 21 | 7.50 [190.5] |
| 7 | 2.25 [57.1] | 22 | 7.87 [200.0] |
| 8 | 2.62 [66.7] | 23 | 8.25 [209.5] |
| 9 | 3.00 [76.2] | 24 | 8.62 [219.1] |
| 10 | 3.37 [85.7] | 25 | 9.00 [228.6] |
| 11 | 3.75 [95.2] | 26 | 9.38 [238.1] |
| 12 | 4.12 [104.8] | 27 | 9.75 [247.7] |
| 13 | 4.50 [114.3] | 28 | 10.13 [257.2] |
| 14 | 4.87 [123.8] | 29 | 10.50 [266.7] |
| 15 | 5.25 [133.3] | 30 | 10.88 [276.2] |
| 16 | 5.62 [142.9] | | |



Note: All part numbers are RoHS Compliant.

0.375" [9.53] Pitch, Series #6, Tri-Barrier (Continued)

Printed Circuit Pin

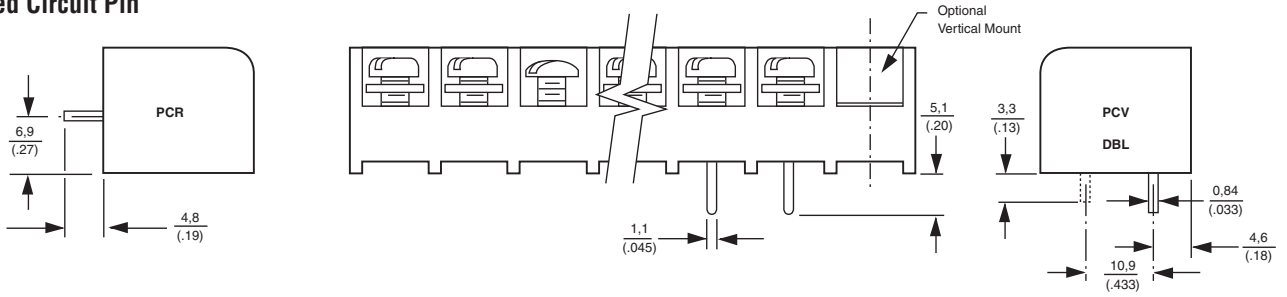

Solder Turret



Wire Wrap



Non-Feed Thru



Barrier Strips

2



Note: All part numbers are RoHS Compliant.

0.375" [9.53] Pitch, Modular w/cover, Tri-Barrier



Material & Finish

Housing Material—Polyamide

Flammability—UL94V-0

Color—Black

Terminals—Brass, tin-plated

Screws—m3.5, steel, nickel plated

Mechanical Properties

Pitch (Terminal Spacing)—
0.375" [9.53]

Recommended PCB Hole Dia.—
1.8mm [0.073"]

Recommended Tightening Torque—
12 in.-lb.

Electrical Properties

Ratings*—UL Class B 15 Amps, 300V
UL Class D 10 Amps, 300V

*Evaluated to U.S. and Canadian Standards.

Wire Range—18-22 AWG

Environmental Properties

Operating Temperature Range—
-40°C to +120°C [-104°F to +248°F]

Circuit Identification—See page 179

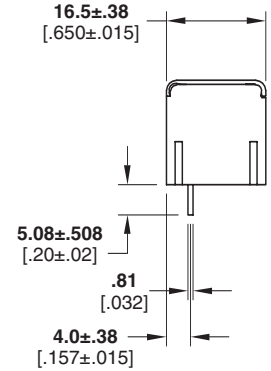

Recommended PC Board Layout

| No. of Positions | Dimension A | Part Numbers |
|------------------|--------------|--------------|
| 2 | .375 [9.5] | 1546833-2 |
| 3 | .750 [19.0] | 1546833-3 |
| 4 | 1.125 [28.6] | 1546833-4 |
| 5 | 1.500 [38.1] | 1546833-5 |
| 6 | 1.875 [47.6] | 1546833-6 |
| 7 | 2.250 [57.1] | 1546833-7 |
| 8 | 2.625 [66.7] | 1546833-8 |



Note: All part numbers are RoHS Compliant.

0.375" [9.53] Pitch, Series BC6

| No. of Positions | Dim. A |
|------------------|--------------|
| 2 | .375 [9.5] |
| 3 | .750 [19.1] |
| 4 | 1.125 [28.6] |
| 5 | 1.500 [38.1] |
| 6 | 1.875 [47.6] |
| 7 | 2.250 [57.1] |
| 8 | 2.625 [66.7] |
| 9 | 3.000 [76.2] |

| No. of Positions | Dim. A |
|------------------|---------------|
| 10 | 3.375 [85.7] |
| 11 | 3.750 [95.2] |
| 12 | 4.125 [104.8] |
| 13 | 4.500 [114.3] |
| 14 | 4.875 [123.8] |
| 15 | 5.250 [133.3] |
| 16 | 5.625 [142.9] |



0.375" [9.53] Pitch, Series BC6

Ordering Information



BC6 - P 1 08 - 08
A
B
C
D

Material & Finish

Housing Material—Polypropylene

Flammability—UL94V-0

Color—Black

Terminals—Bright acid tin over copper alloy

Screws—#6-32 steel, zinc plating with clear chromate coating. Wire clamping screws and binding head screws available.

Mechanical Properties

Pitch (Terminal Spacing)—0.375" [.525]

Recommended PCB Hole Dia.—1.8mm [.073"]

Electrical Properties

Ratings—UL Class C 20 Amps, 300V
 UL Class D 5 Amps, 600V
 CSA Type C 20 Amps, 300V

Wire Range—12-22 AWG

Environmental Properties

Operating Temperature Range—105°C [221°F] max.

Circuit Identification—See page 179

Hardware Options

TC2—Safety covers, see page 174

QC2x—250 Quick connects, see page 176

QC4x—187 Quick connects, see page 176

ST80—Single sided solder tabs, see page 176

1437661-7—Retaining clip, Insulating turret, see page 178

J6—Jumpers, see page 177

1437651-2—Wire clamp screw, steel, see page 178

1437651-5—Wire clamp screw, brass, see page 178

1437651-8—Binding head screw, steel, see page 178

L03—Binding head screw, stainless, see page 178

A Terminal Style

P=Printed Circuit (available with 1,2,5 block style only)

T=Solder Turret

Q=Quick Connect .250

W=Solderless Wrap

E=Extended Circuit Board

F=Quick Connect .187

B Block Style

1=Flat, all positions filled (standard)

2=Flat, end mounting ears with holes (required for cover option)

3=Insulating turret, end mounting ears with holes (required for cover option)

4=Insulating turret, all positions filled

5=Flat, end positions open with mounting bushings

6=Insulating turret, end positions open with mounting bushings

C Screw Hardware

07=Steel binding combo head screw

08=Steel wire-clamp combo head screw (standard)

05=Brass binding combo head screw

06=Brass wire-clamp combo head screw

D No. of Circuits (Not Positions)

02 to 25 circuits

Note: All part numbers are RoHS Compliant.

0.375" [9.53] Pitch, Series MB6, Double Level

MB6-P108-##



Material & Finish

Housing Material—Thermoplastic polyamide

Flammability—UL94V-0

Color—Black

Terminals—Bright acid tin over copper alloy

Screws—#6-32 steel, zinc plating with clear chromate coating.

Mechanical Properties

Pitch (Terminal Spacing)—
.375" [9.525]

Recommended PCB Hole Dia.—
1.8mm [.073"]

Electrical Properties

Ratings—UL Class C 25 Amps, 300V
CSA Type C 25 Amps, 600V

Wire Range—12-22 AWG

Environmental Properties

Operating Temperature Range—
105°C [221°F] max.

Hardware Options

1437651-2—Wire clamp screw, see page 178



Printed Circuit Board Layout

ORDERING INFORMATION

MB6 - P1 08 - 04

- A Series**
MB6=Double Level, 0.375" Centers
- B Terminal Style**
P1=Printed Circuit Pin, Vertical
- C Screw Hardware**
08=Steel wire clamp combo head screws
- D 02 through 40** available in multiples of 2



| No. of Positions | Dim. A | No. of Positions | Dim. A |
|------------------|--------------|------------------|---------------|
| 4 | 0.375 [9.5] | 24 | 4.125 [104.8] |
| 6 | 0.750 [19.1] | 26 | 4.500 [114.3] |
| 8 | 1.125 [28.6] | 28 | 4.875 [123.8] |
| 10 | 1.500 [38.1] | 30 | 5.250 [133.3] |
| 12 | 1.875 [47.6] | 32 | 5.625 [142.9] |
| 14 | 2.250 [57.1] | 34 | 6.000 [152.4] |
| 16 | 2.625 [66.7] | 36 | 6.375 [161.9] |
| 18 | 3.000 [76.2] | 38 | 6.750 [171.4] |
| 20 | 3.375 [85.7] | *40 | 7.125 [181.0] |
| 22 | 3.750 [95.2] | | |

* Longer lengths available.
Please consult Technical Support.



Barrier Strips
2

Note: All part numbers are RoHS Compliant.

0.4375" [11.1] Pitch, Series #8

#8 Series Tri-Barriers

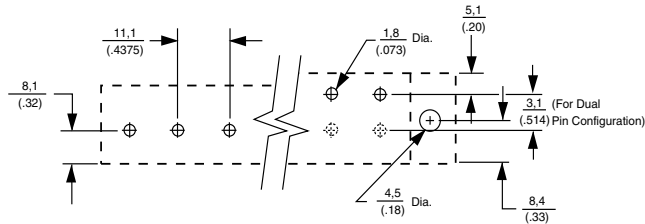

RIGHT ANGLE VERTICAL PRINTED CIRCUIT BOARD LAYOUT

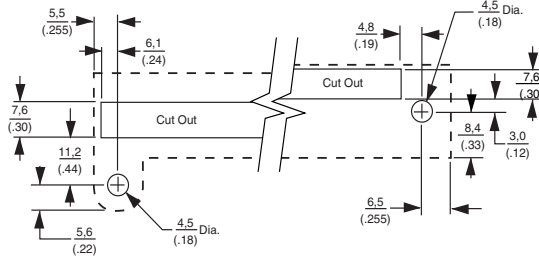

RIGHT ANGLE VERTICAL MOUNTING PANEL LAYOUT

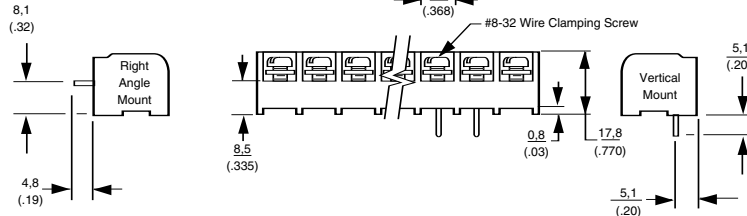
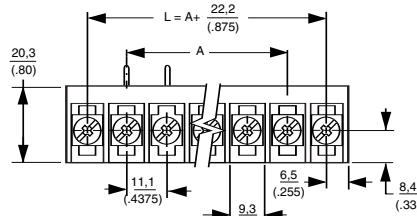

Material & Finish

Housing Material—Polypropylene

Flammability—UL94V-0

Color—Black

Terminals—Bright acid tin over copper alloy

Screws—#8-32 steel, zinc plating with clear chromate coating. Wire clamping screws and binding head screws with undercut available.

Mechanical Properties

Pitch (Terminal Spacing)—.4375" [11.1]

Recommended PCB Hole Dia.—1.8mm [.073"]

Electrical Properties

Ratings—UL Class C 30 Amps, 600V
CSA Type C 30 Amps, 600V

Wire Range—10-18 AWG (UL)
10-22 AWG (CSA)

Environmental Properties

Operating Temperature Range—105°C [221°F] max.

Circuit Identification—See page 179

Hardware Options

TC8—Safety covers, see page 174

QC8—Quick connects, see page 176

J8—Jumpers, see page 177

1437425-1—Wire clamp screw, see page 178

1437429-1—Binding head screw, steel, see page 178

| No. of Positions | Dim. A |
|------------------|---------------|
| 2 | 0.4375 [11.1] |
| 3 | 0.87 [22.2] |
| 4 | 1.31 [33.3] |
| 5 | 1.75 [44.5] |
| 6 | 2.19 [55.6] |
| 7 | 2.62 [66.7] |
| 8 | 3.06 [77.8] |
| 9 | 3.50 [88.9] |
| 10 | 3.93 [100.0] |
| 11 | 4.37 [111.1] |
| 12 | 4.81 [122.2] |
| 13 | 5.25 [133.3] |
| 14 | 5.69 [144.5] |

| No. of Positions | Dim. A |
|------------------|---------------|
| 15 | 6.12 [155.6] |
| 16 | 6.56 [166.7] |
| 17 | 7.00 [177.8] |
| 18 | 7.44 [188.9] |
| 19 | 7.87 [200.0] |
| 20 | 8.31 [211.1] |
| 21 | 8.75 [222.2] |
| 22 | 9.19 [233.4] |
| 23 | 9.62 [244.5] |
| 24 | 10.06 [255.6] |
| 25 | 10.50 [266.7] |
| 26 | 10.94 [277.8] |



0.4375" [11.1] Pitch, Series #8 (Continued)

Ordering Information

8 PCV-04-006

A **B** **C** **D**

A Screw Size Spacing

8 = #8-32 on .4375" Centers

C No. of Circuits (Not positions)

02 through 26

B Terminal Style

- DBL** = Double Printed Circuit Pin
- PCR** = Printed Circuit, Right Angle
- PCV** = Printed Circuit Pin, Vertical
- QCR** = Quick Connect Tab, Right Angle
- QCV** = Quick Connect Tab, Vertical
- STR** = Solder Turret, Right Angle
- STV** = Solder Turret, Vertical
- TBV** = Non Feed Thru
- WWR** = Solderless Wire Wrap, Right Angle
- WWV** = Solderless Wire Wrap, Vertical

D Modifiers

- Use table below.
- 002=-006 except brass screw
- 003=-007 except brass screw



Phil-slot Head

| Terminal Style | Modifier Phil-slot Head | Screw Style | Mounting Construction |
|----------------|-------------------------|--------------|-----------------------|
| DBL | 006 | Wire Clamp | No Mounting |
| | 007 | Binding Head | |
| PCV | 006 | Wire Clamp | No Mounting |
| | 007 | Binding Head | |
| | 008 | Wire Clamp | |
| | 009 | Binding Head | |
| PCR | 006 | Wire Clamp | |
| | 007 | Binding Head | |
| | 008 | Wire Clamp | |
| | 009 | Binding Head | |
| QCV | 006 | Wire Clamp | |
| STV | | Wire Clamp | |
| WWV | | Wire Clamp | |
| QCR | 006 | Wire Clamp | |
| STR | | Wire Clamp | |
| WWR | | Wire Clamp | |
| TBV | 006 | Wire Clamp | |



Note: All part numbers are RoHS Compliant.

0.4375" [11.1] Pitch, Series #8 (Continued)

Printed Circuit Pin



Solder Turret

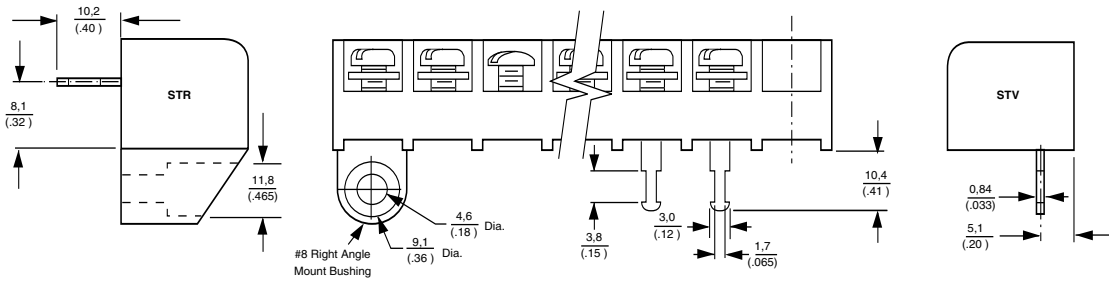

Wire Wrap

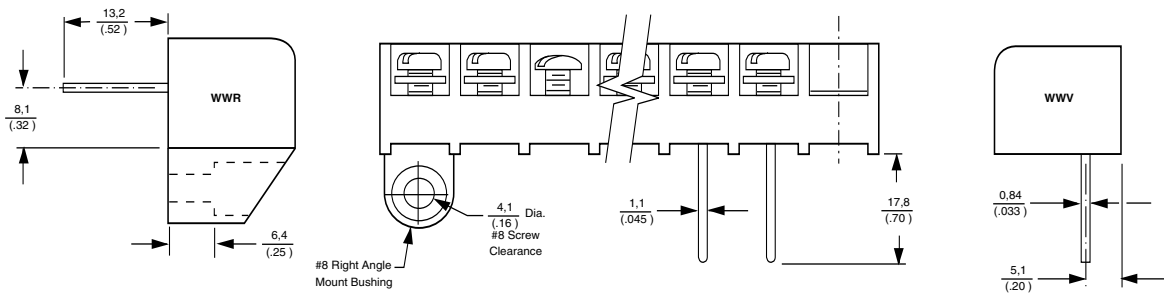

Quick Connect



Non-Feed Thru



Dual-Barrier Strips

Product Facts

- n Industrial controls and automation
- n Machine tools
- n HVAC/R
- n Power supplies
- n Security/Irrigation
- n Transformers

Design Advantages

- n Fast wiring – backed-out wire-ready screws
- n Interrupted thread designed to prevent screws from falling out
- n Standoffs allow flux and solvents to drain during cleaning
- n Molded-to-length or cut-to-length versions available



The Dual-Barrier design provides a more cost-effective solution than the Tri-Barrier Strips while still supplying many of the design advantages.

Connector Index

Single Row

| | |
|---|----------|
| 0.250" Pitch, Series 1546657 | 141, 142 |
| 0.325" Pitch, Series 4DB | 143-144 |
| 0.325" Pitch, High Rise | 145-146 |
| 0.325" Pitch, Series SSB3..... | 168-170 |
| 0.375" Pitch, Series JC6 | 147, 148 |
| 0.375" Pitch, Series NC6, Low Profile | 149, 150 |
| 0.4375" Pitch, Series SSB7..... | 151-154 |

Double Row, Panel Mount

| | |
|--------------------|-----|
| 0.374" Pitch | 156 |
| 0.433" Pitch | 157 |
| 0.437" Pitch | 158 |
| 0.563" Pitch | 160 |

Note: All part numbers
are RoHS Compliant.

Engineering Notes



High-Density, Dual-Barrier Strips, .250" [6.35] Centerline

Product Facts

- High density accommodates today's compact PCB layouts



Material & Finish

- Insulator Body**—UL 94V-0 thermoplastic, black
- Terminal**—Brass, tin-plated
- Screw**—M3, Steel, nickel-plated

Mechanical Properties

- Recommended Tightening Torque**—10 in-lbs
- Combination drive screws with #2 Phillips recess and standard slot

Electrical Properties

- Current Rating**—10 A
- Voltage Rating**—300 VAC/DC per UL and CSA standards
- Wire Range**—16-30 AWG Copper, Solid or Stranded

Environmental Properties

- Operating Temperature**—40°F to +221°F [-40°C to +115°C]
- Circuit Identification**—See page 179

Hardware Options

- TC8**—Safety cover, see page 174
- QC8**—Quick connects, see page 176
- J8**—Jumpers, see page 177
- 1437425-1**—Wire clamp screw, see page 178
- 1437429-1**—Binding head screw, steel, see page 178



Note: All part numbers are RoHS Compliant.

High-Density, Dual-Barrier Strips, .250" [6.35] Centerline (Continued)

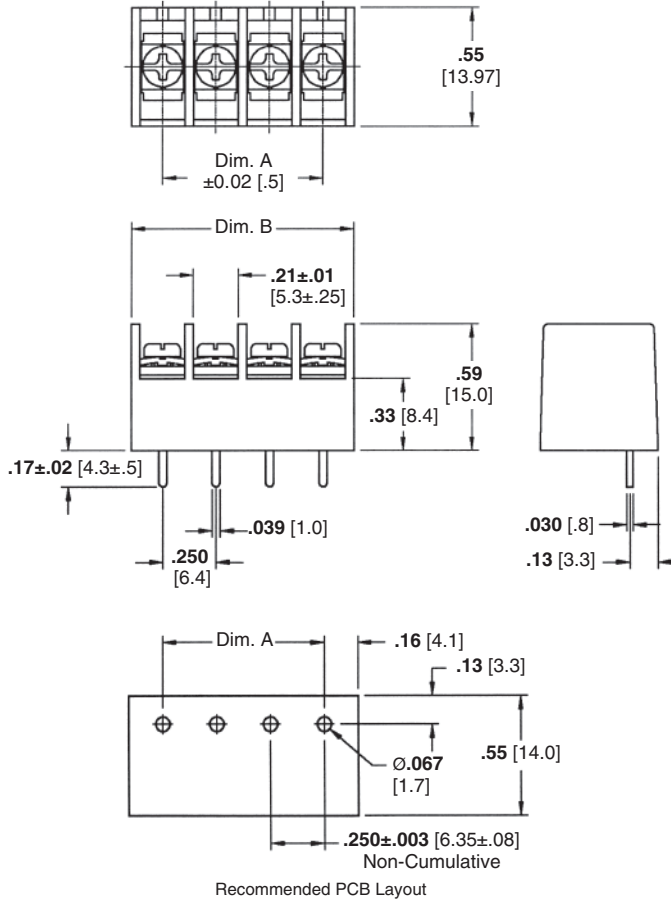

| No. of Positions | Dimension | | Part Number |
|------------------|--------------|-------------|-------------|
| | A | B | |
| 2 | 0.250 [6.35] | 0.54 [13.7] | 1546657-2 |
| 3 | 0.500 [12.7] | 0.79 [20.1] | 1546657-3 |
| 4 | 0.750 [19.1] | 1.04 [26.4] | 1546657-4 |
| 5 | 1.000 [25.4] | 1.29 [32.8] | 1546657-5 |
| 6 | 1.250 [31.8] | 1.54 [39.1] | 1546657-6 |
| 7 | 1.500 [38.1] | 1.79 [45.5] | 1546657-7 |
| 8 | 1.750 [44.4] | 2.04 [51.8] | 1546657-8 |
| 9 | 2.000 [50.8] | 2.29 [58.2] | 1546657-9 |
| 10 | 2.250 [57.2] | 2.54 [64.5] | 1-1546657-0 |
| 11 | 2.500 [63.5] | 2.79 [70.9] | 1-1546657-1 |
| 12 | 2.750 [69.9] | 3.04 [77.2] | 1-1546657-2 |
| 13 | 3.000 [76.2] | 3.29 [83.6] | 1-1546657-3 |
| 14 | 3.250 [82.6] | 3.54 [90.0] | 1-1546657-4 |
| 15 | 3.500 [88.9] | 3.79 [96.3] | 1-1546657-5 |

| No. of Positions | Dimension | | Part Number |
|------------------|---------------|--------------|-------------|
| | A | B | |
| 16 | 3.750 [95.3] | 4.04 [102.6] | 1-1546657-6 |
| 17 | 4.000 [101.6] | 4.29 [108.9] | 1-1546657-7 |
| 18 | 4.250 [107.9] | 4.54 [115.3] | 1-1546657-8 |
| 19 | 4.500 [114.3] | 4.79 [121.7] | 1-1546657-9 |
| 20 | 4.750 [120.6] | 5.04 [128.0] | 2-1546657-0 |
| 21 | 5.000 [127.0] | 5.29 [134.4] | 2-1546657-1 |
| 22 | 5.250 [133.3] | 5.54 [140.7] | 2-1546657-2 |
| 23 | 5.500 [139.7] | 5.79 [147.1] | 2-1546657-3 |
| 24 | 5.750 [146.1] | 6.04 [153.4] | 2-1546657-4 |
| 25 | 6.000 [152.4] | 6.29 [159.8] | 2-1546657-5 |
| 26 | 6.250 [158.8] | 6.54 [166.1] | 2-1546657-6 |
| 27 | 6.500 [165.1] | 6.79 [172.5] | 2-1546657-7 |
| 28 | 6.750 [171.5] | 7.04 [178.8] | 2-1546657-8 |
| 29 | 7.000 [177.8] | 7.29 [185.2] | 2-1546657-9 |
| 30 | 7.250 [184.2] | 7.54 [191.5] | 3-1546657-0 |



0.325" [8.26] Pitch, Series 4DB

4DB-P108-##



Material & Finish

Housing Material—Thermoplastic Polyamide

Flammability—UL94V-0

Color—Black

Terminals—Bright acid-tin over copper alloy

Screws—#6-32 steel, zinc plating with clear chromate coating. Wire clamping screws and binding head screws available.

Mechanical Properties

Pitch (Terminal Spacing)—0.325" [9.525]

Recommended PCB Hole Dia.—1.7mm [0.07"]

Electrical Properties

Ratings—UL Class C 20 Amps, 150V
 UL Class D 10 Amps, 300V
 CSA Type B 20 Amps, 300V
 CSA Type C 20 Amps, 300V
 CSA Type D 10 Amps, 300V
 CSA Type E 20 Amps, 300V

Wire Range—12-22 AWG

Environmental Properties

Operating Temperature Range—105°C [221°F] max.

Circuit Identification—See page 179

Hardware Options

QC4—Quick connects, see page 176

J4—Jumpers, see page 177

9-1437667-9—Wire clamp screw, see page 178

Ordering Information

4DB - P 1 08 - 06

A **B** **C** **D** **E**

A Series

4DB = Dual-Barrier, 0.325" Centers

B Terminal Style

P = Printed Circuit Pin

W = Wire Wrap

R = Right Angle

C Block Style

1 = Flat, all positions filled

2 = Flat, end mounting holes

D Screw Type

07 = Steel binding combo head screws

08 = Steel wire clamp combo head screws

E No. of Circuits (Not Positions)

02 through 30

Barrier Strips
2



Note: All part numbers are RoHS Compliant.

0.325" [8.26] Pitch, Series 4DB (Continued)



PRINTED CIRCUIT BOARD LAYOUT

Bend Options:

A variety of bend options are available. Please consult Technical Support for details.

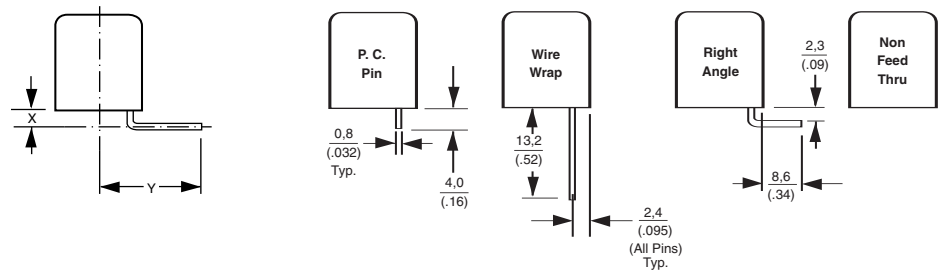

| No. of Positions | Dim. A |
|------------------|---------------|
| 2 | 0.325 [8.2] |
| 3 | 0.650 [16.5] |
| 4 | 0.975 [24.8] |
| 5 | 1.300 [33.0] |
| 6 | 1.625 [41.3] |
| 7 | 1.950 [49.5] |
| 8 | 2.275 [57.8] |
| 9 | 2.600 [66.0] |
| 10 | 2.925 [74.3] |
| 11 | 3.250 [82.5] |
| 12 | 3.575 [90.8] |
| 13 | 3.900 [99.1] |
| 14 | 4.225 [107.3] |
| 15 | 4.550 [115.6] |
| 16 | 4.875 [123.8] |

| No. of Positions | Dim. A |
|------------------|---------------|
| 17 | 5.200 [132.1] |
| 18 | 5.525 [140.3] |
| 19 | 5.850 [148.6] |
| 20 | 6.175 [156.8] |
| 21 | 6.500 [165.1] |
| 22 | 6.825 [173.3] |
| 23 | 7.150 [181.6] |
| 24 | 7.475 [190.0] |
| 25 | 7.800 [198.1] |
| 26 | 8.125 [206.4] |
| 27 | 8.450 [214.6] |
| 28 | 8.775 [222.8] |
| 29 | 9.100 [231.1] |
| 30 | 9.425 [239.4] |



High Rise Dual-Barrier Strips, .325 [8.26] Centerline

Product Facts

- High rise profile provides wire entry access on congested PC boards
- Space saving high rise design allows for dual-level wire entry when used with 4DB series barrier strips
- Captive screws provided in wire-ready position



Material & Finish

Insulator Body—UL 94V-0 Thermoplastic, Black

Terminal—Brass, Tin plated

Mechanical Properties

Recommended Tightening

Torque—10 in-lbs

Combination drive screws with #2 Phillips Recess and Standard Slot

Electrical Properties

Current Rating—10 A

Voltage Rating—20 A, 300 VAC/DC per UL and CSA standards

Wire Range—12-22 AWG Cu, Solid or Stranded

Environmental Properties

Operating Temperature—40°F to +221°F [-40°C to +105°C]

Circuit Identification—See page 179

Hardware Options

J4—Jumpers, see page 177

Note: All part numbers are RoHS Compliant.

High Rise Dual-Barrier Strips, .325 [8.26] Centerline (Continued)



Recommended PC Board Layout

| No of Positions | Dimension | | Part Number |
|-----------------|----------------|----------------|-------------|
| | A | B | |
| 2 | 0.725 [18.42] | 0.325 [8.26] | 1546734-2 |
| 3 | 1.050 [26.67] | 0.650 [16.51] | 1546734-3 |
| 4 | 1.375 [34.93] | 0.975 [24.77] | 1546734-4 |
| 5 | 1.700 [43.18] | 1.300 [33.02] | 1546734-5 |
| 6 | 2.025 [51.44] | 1.625 [41.28] | 1546734-6 |
| 7 | 2.350 [59.69] | 1.950 [49.53] | 1546734-7 |
| 8 | 2.675 [67.95] | 2.275 [57.79] | 1546734-8 |
| 9 | 3.000 [76.20] | 2.600 [66.04] | 1546734-9 |
| 10 | 3.325 [84.46] | 2.925 [74.29] | 1-1546734-0 |
| 11 | 3.650 [92.71] | 3.250 [82.55] | 1-1546734-1 |
| 12 | 3.975 [100.97] | 3.575 [90.81] | 1-1546734-2 |
| 13 | 4.300 [109.22] | 3.900 [99.06] | 1-1546734-3 |
| 14 | 4.625 [117.48] | 4.225 [107.32] | 1-1546734-4 |
| 15 | 4.950 [125.73] | 4.550 [115.57] | 1-1546734-5 |
| 16 | 5.275 [133.99] | 4.875 [123.83] | 1-1546734-6 |



0.375" [9.53] Pitch, Series JC6

JC6-P107-03

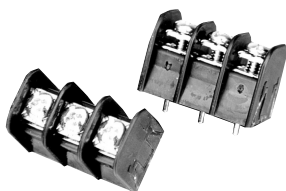

Material & Finish

Housing Material—Polypropylene

Flammability—UL94V-0

Color—Black

Terminals—Bright acid-tin over copper alloy

Screws—#6-32 steel, zinc plating with clear chromate coating. Wire clamping screws and binding head screws available.

Mechanical Properties

Pitch (Terminal Spacing)—0.375" [9.525]

Recommended PCB Hole Dia.—1.8mm [.073"]

Electrical Properties

Ratings—UL Class C 20 Amps, 300V
 UL Class D 5 Amps, 600V
 CSA Type B 20 Amps, 300V
 CSA Type C 20 Amps, 300V
 CSA Type D 5 Amps, 600V
 CSA Type E 20 Amps, 600V

Wire Range—12-22 AWG

Environmental Properties

Operating Temperature Range—105°C [221°F] max.

Circuit Identification—See page 179

Hardware Options

TC9—Safety cover, see page 174

QC2x—.250 Quick connects, see page 176

QC4x—.187 Quick connects, see page 176

J6—Jumpers, see page 177

J7x—Over-the-barrier jumpers, see page 177

1437661-7—Retaining clips, insulating turrets, see page 178

1437651-2—Wire clamp screw, steel, see page 178

1437651-5—Wire clamp screw, brass, see page 178

1437651-8—Binding head screw, steel, see page 178

L03—Binding head screw, stainless, see page 178

Ordering Information

JC6 - P 1 07 - 06

A **B** **C** **D** **E**

A Series

JC6 = Dual-Barrier, 0.375" Centers

B Terminal Style

C = Non Feed Thru

E = Extended Circ. Bd.

F = Quick Connect, .187

P = Printed Circuit Pin (available with 1, 2 Block Style)

T = Solder Turret

Q = Quick Connect, .250

W = Solderless Wrap

C Block Style

1 = Flat, all positions filled

2 = Flat, end mounting ears (required for cover option)

3 = Insulating turret, end mounting ears with holes (required for cover option)

4 = Insulating turret, all positions filled

5 = Flat, open end with mounting bracket

6 = Flat, open end, mounting bracket, insulating turret

7 = Closed bottom, end mounting ears. (for C style terminal only)

D Screw Hardware

05 = Brass binding combo head screws

06 = Brass wire-clamp combo head screws

07 = Steel binding combo head screws

08 = Steel wire-clamp combo head screws (standard)

E No. of Circuits (Not positions)

02 through **25**

Note: All part numbers are RoHS Compliant.

0.375" [9.53] Pitch, Series JC6 (Continued)

| No. of Positions | Dim. A |
|------------------|---------------|
| 2 | 0.325 [8.2] |
| 2 | 0.375 [9.5] |
| 3 | 0.750 [19.1] |
| 4 | 1.125 [28.6] |
| 5 | 1.500 [38.1] |
| 6 | 1.875 [47.6] |
| 7 | 2.250 [57.1] |
| 8 | 2.625 [66.7] |
| 9 | 3.000 [76.2] |
| 10 | 3.375 [85.7] |
| 11 | 3.750 [95.2] |
| 12 | 4.125 [104.8] |
| 13 | 4.500 [114.3] |

| No. of Positions | Dim. A |
|------------------|----------------|
| 14 | 4.875 [123.8] |
| 15 | 5.250 [133.3] |
| 16 | 5.625 [142.9] |
| 17 | 6.000 [152.4] |
| 18 | 6.375 [161.9] |
| 19 | 6.750 [171.45] |
| 20 | 7.125 [180.98] |
| 21 | 7.500 [190.5] |
| 22 | 7.875 [200.03] |
| 23 | 8.250 [209.55] |
| *24 | 8.625 [219.08] |
| *25 | 9.000 [228.60] |

* No mounting available



PRINTED CIRCUIT BOARD/MOUNTING PANEL LAYOUT

Bend Options

A variety of bend styles are available. Please consult Technical Support for details.



Available Block Styles: 1/2/5



Available Block Styles: 2/3/4/5/6



Available Block Styles: 2/3/4/5/6



Available Block Styles: 2/3/4

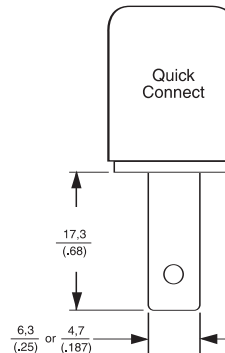

Available Block Styles: 1/2/3/4/5/6

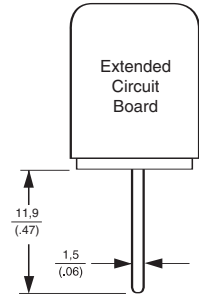

Available Block Styles: 7

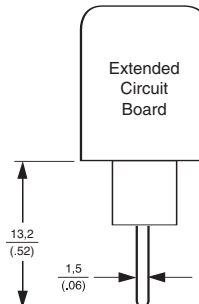
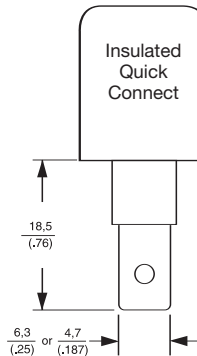
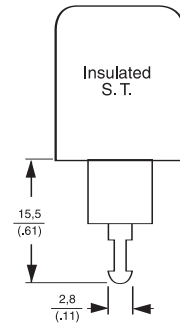
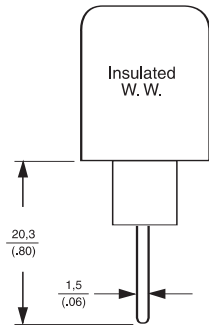
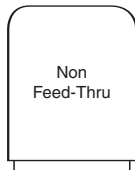

LR30811 E54800

0.375" [9.53] Pitch, NC6 Series, Low Profile

NC6-P108-03



Material & Finish

Housing Material—Thermoplastic polyamide

Flammability—UL94V-0

Color—Black

Terminals—Bright acid tin over copper alloy

Screws—#6-32 steel, zinc plating with clear chromate coating. Wire clamping screws and binding head screws available.

Mechanical Properties

Pitch (Terminal Spacing)—
.375" [9.525]

Screw Size—#6-32 steel

Recommended PCB Hole Dia.—
1.8mm [.073"] dia.

Electrical Properties

Ratings—UL Class C 20 Amps, 300V
CSA Type C 20 Amps, 300V

Wire Range—12-22 AWG

Environmental Properties

Operating Temperature Range—
105°C [221°] max.

Circuit Identification—See page 179

Hardware Options

1437651-2—Wire clamp screw, steel, see page 178

1437651-5—Wire clamp screw, brass, see page 178

1437651-8—Binding head screw, steel, see page 178

L03—Binding head screw, stainless, see page 178

Ordering Information

NC6 - P 1 08- 04

A B C D E

A Series
NC6 = Dual-Barrier, 0.375" Centers, Low Profile

B Terminal Style
P = Printed Circuit Pin

C Block Style
1 = Flat, all positions filled
2 = End mounting holes provided

D Screw Hardware
05 = Brass binding combo head screws
06 = Brass wire-clamp combo head screws
07 = Steel binding combo head screws
08 = Steel wire-clamp combo head screws

E No. of Circuits (Not positions)
02 through 24

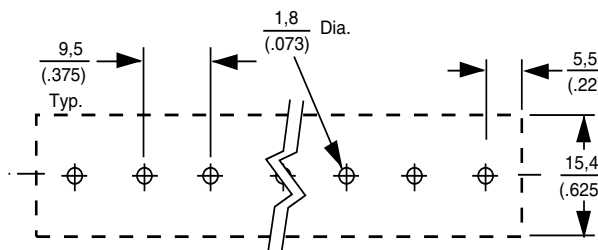

RECOMMENDED PCB HOLE LAYOUT

Note: All part numbers are RoHS Compliant.

0.375" [9.53] Pitch, NC6 Series, Low Profile (Continued)



| No. of Positions | Dim. A |
|------------------|---------------|
| 2 | 0.375 [9.5] |
| 3 | 0.750 [19.1] |
| 4 | 1.125 [28.6] |
| 5 | 1.500 [38.1] |
| 6 | 1.875 [47.6] |
| 7 | 2.250 [57.1] |
| 8 | 2.625 [66.7] |
| 9 | 3.000 [76.2] |
| 10 | 3.375 [85.7] |
| 11 | 3.750 [95.2] |
| 12 | 4.125 [104.8] |
| 13 | 4.500 [114.3] |

| No. of Positions | Dim. A |
|------------------|---------------|
| 14 | 4.875 [123.8] |
| 15 | 5.250 [133.3] |
| 16 | 5.625 [142.9] |
| 17 | 6.000 [152.4] |
| 18 | 6.375 [161.9] |
| 19 | 6.750 [161.9] |
| 20 | 7.125 [171.4] |
| 21 | 7.500 [181.0] |
| 22 | 7.875 [190.5] |
| *23 | 8.250 [200.0] |
| *24 | 8.625 [209.6] |

* No mounting available

Note: All part numbers are RoHS Compliant.

0.4375" [11.1] Pitch, Series SSB7

SSB7FP##0202



Material & Finish

- Housing Material**—Polypropylene
- Flammability**—UL94V-2
- Color**—Black
- Terminals**—Brass, bright acid tin over copper plating
- Screw**—#6-32 Steel with zinc + chromate plating

Mechanical Properties

- Pitch (Terminal Spacing)**—
.4375 in. [11.1]
- Recommended PCB Hole Dia.**—
.077" [1.955]
- Wire Strip Length**—
.38" [9.652]
- Recommended Tightening Torque**—
8 in.-lbs.
- Recommended Screwdrivers**—
Stanley 1006-4, Sears Craftsman 41581, Any #2 Phillips-Head
- Wire Lug Width (Max.)**—
8.1mm [0.320 in.]

Electrical Properties

- Ratings**—UL Class B 20 Amps, 600V
UL Class C 20 Amps, 600V
CSA Type C 20 Amps, 300V
CSA Type D, 5 Amps, 600V

- Wire Range**—12-22 AWG
- Dielectric Withstand**—5000V

Environmental Properties

- Operating Temperature Range**—
60°C to +105°C [-76°F to +221°F]

Computing Barrier Block Lengths

- Direct Mounting**—Use C1 and L1 for P & H mounting options
- End Position Mounting**—Use L2 and C2 for M, E, F & G mounting options



| Circuits (not positions) | C1 in. | L1* in. | C2 in. | L2* in. |
|--------------------------|--------|---------|--------|---------|
| 01 | — | — | 0.88 | 1.44 |
| 02 | 0.44 | 1.00 | 1.31 | 1.88 |
| 03 | 0.88 | 1.44 | 1.75 | 2.31 |
| 04 | 1.31 | 1.88 | 2.19 | 2.75 |
| 05 | 1.75 | 2.31 | 2.63 | 3.19 |
| 06 | 2.19 | 2.75 | 3.06 | 3.63 |
| 07 | 2.63 | 3.19 | 3.50 | 4.06 |
| 08 | 3.06 | 3.63 | 3.94 | 4.50 |
| 09 | 3.50 | 4.06 | 4.38 | 4.94 |
| 10 | 3.94 | 4.50 | 4.81 | 5.38 |
| 11 | 4.38 | 4.94 | 5.25 | 5.81 |
| 12 | 4.81 | 5.38 | 5.69 | 6.25 |
| 13 | 5.25 | 5.81 | 6.13 | 6.69 |
| 14 | 5.69 | 6.25 | 6.56 | 7.13 |
| 15 | 6.13 | 6.69 | 7.00 | 7.56 |
| 16 | 6.56 | 7.13 | 7.44 | 8.00 |
| 17 | 7.00 | 7.56 | 7.88 | 8.44 |
| 18 | 7.44 | 8.00 | 8.31 | 8.88 |
| 19 | 7.88 | 8.44 | 8.75 | 9.31 |
| 20 | 8.31 | 8.88 | 9.19 | 9.75 |
| 21 | 8.75 | 9.31 | 9.63 | 10.19 |
| 22 | 9.19 | 9.75 | 10.06 | 10.63 |
| 23 | 9.63 | 10.19 | 10.50 | 11.06 |
| 24 | 10.06 | 10.63 | 10.94 | 11.50 |
| 25 | 10.50 | 11.06 | 11.38 | 11.94 |
| 26 | 10.94 | 11.50 | — | — |
| 27 | 11.38 | 11.94 | — | — |

Note: All part numbers are RoHS Compliant.

0.4375" [11.1] Pitch, Series SSB7 (Continued)

Ordering Information

SSB 7 F P 06 02 02 11

A B C D E F G H

- A Single Screw Dual-Barrier Strip SSB**
- B Contact Spacing (Center-to-Center)**
7 = .4375 (7/16)
- C Base Options**
C=Closed Base
F=Flat Base
R=Raised Base
T=Turret Base
(Available only with 01, 04, 05, 07, 09, 12, 13, 15 style bottom terminals)
- D Mounting Options**
(See illustration below)
E=Open end positions, with mounting inserts, with end barriers
F=Open end positions, without mounting inserts, without end barriers
G=Open end positions, with mounting inserts, without end barriers
M=Open end positions, without mounting inserts, with end barriers
P=All positions filled with contacts, with end barriers



- E No. of Circuits (Not Positions)**
Must conform to mounting options
02 to 32 circuits (P & H mounting)
02 to 27 circuits (M, E, F & G mounting)
- F Terminal Style**
01=Solder Tail
02=Printed Circuit Pin
03=Non-Feed Through (with C base only)
04=Extended Printed Circuit Pin
05=Quick Connects
06=90° bend, .46" x .11" (with F base only)
07=Wire Wrap
08=90° bend, .75" x .11" (with F base only)
12=90° bend, .21" x .65"
13=90° bend, .36" x .50"
14=90° bend, .41" x .16" (with F base only)
15=90° bend, .51" x .35"
16=90° bend, .32" x .25" (with F base only)
- G Top Hardware Options**
00=No top hardware (Separately packaged binding head screws supplied at no cost)
01=Bright zinc and chromate plated steel binding head screw
02=Bright zinc and chromate plated steel screw and captive clamp - Do not order with other top hardware
03=Stainless steel binding head screw
04=Nickel plated brass binding head screw
09=Nickel plated brass screw and captive clamp - Do not order with other top hardware

80=Single-sided solder tab
81=Double-sided solder tab

Quick-Connect Blades
(supplied with 01 screw)

| | | .250 wide | .187 wide |
|----|----|-----------|-----------|
| | | x.032 | x.020 |
| | | thick | thick |
| 20 | 40 | | |
| 21 | 41 | | |
| 22 | 42 | | |
| 23 | 43 | | |
| 24 | 44 | | |
| 25 | 45 | | |
| 26 | 46 | | |
| 27 | 47 | | |
| 28 | 48 | | |
| 29 | 49 | | |
| 30 | 50 | | |
| 31 | 51 | | |
| 32 | 52 | | |
| 33 | 53 | | |
| 34 | 54 | | |
| 35 | 55 | | |
| 36 | 56 | | |

H Circuit Identification Options

| | | |
|----|---|-----------------|
| 11 | = | 12345... |
| 12 | = | ...54321 |
| 13 | = | ← 1 2 3 4 5 ... |
| 14 | = | ... ← 5 4 3 2 1 |
| 15 | = | 12345... ← |
| 16 | = | ... ← 54321 |

0.4375" [11.1] Pitch, Series SSB7 (Continued)

Contact Spacing Options:

.4375 in (7/16") Spacing

Extra thick barriers provide higher voltage rating. Up to 27 ckts. (25 circuits for end mounted blocks)

Base Options:

Closed Base

Catalog Letter Code: C.

For terminal junction-blocks requiring top connections only. Useful in applications requiring single point circuit terminations or circuit completion via top mounted, single- and two-sided quick-connects. Replace double-row barrier strips.



Flat Base

Catalog Letter Code: F.

Lends itself most readily to applications where direct top-to-bottom feed-through is required with no special requirement for circuit isolation on the bottom side. The most common example of this is printed circuit board mounting.



Raised Base

Catalog Letter Code R. Standoffs between each circuit raise block .030" above mounting surface to allow flux and solvents to drain during soldering operations. Available only with 02 and 04 bottom terminals.

Turret Base

Catalog Letter Code: T.

Combines top-to-bottom feed-through with bottom-side circuit isolation for panels up to .126" thick. Turret bases are available with the following terminals: solder tail, quick connect, machine wrap, extended circuit board terminal, and right-angle.



Mounting Options:

End Position

Mounting

Catalog Letter Codes: E, F, G

or M. Supplied without contacts in end sections to allow installer to mount blocks with screws in end section holes. Base of block will support mounting screws (Codes F & M). Also available with mounting inserts installed in end mounting holes to raise mounting screw heads to the level of other top hardware (Codes E & G).

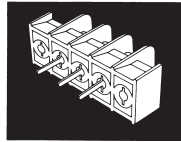

Without End Barriers

Catalog Letter Codes: F, G & H.

Facilitates mounting-screw access when end sections are used for mounting.

Direct Mounting

Catalog Letter Codes: P & H.

SSBs may be solder-mounted using the bottom terminals themselves, as in the case of printed circuit board applications.

Direct mounting is also possible with turret base models using press-on retaining clips (Catalog No. L97, Part Number 1437661-7) on turrets.

Hardware Options

7C1xx—Safety cover, see page 175

QC2x—.250 Quick connects, see page 176

QC4x—.187 Quick connects, see page 176

ST80—Single sided solder tabs, see page 176

1776090-x—Extra long Quick connects, see page 176

J7—Jumpers, see page 177

L91—Mounting insert, see page 178

L92—Angle bracket, see page 178

Terminal Style:

Solder Tail

Catalog Number Code: 01.

For applications requiring a wrapped solder connection.

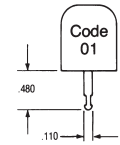

Printed Circuit Pin

Catalog Number Code: 02.

Designed specifically for mounting on .063" thick circuit board. Special, readily solderable plating permits good fillet development in automated soldering processes.

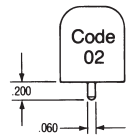

Non-Feed-Through

Catalog Number Code: 03.

With closed base option only.



Extended Printed Circuit Pin

Catalog Number Code: 04.

Useful where extra length is needed, as in thicker printed circuit boards or single-wrap connections.

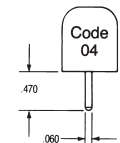

Quick Connect

Catalog Number Code: 05.

.250 in. wide x .032" thick blades accept .250" female quick connects.

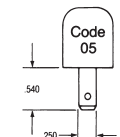

Note: All part numbers are RoHS Compliant.

0.4375" [11.1] Pitch, Series SSB7 (Continued)

**Mounting Position:
Right-Angle**

Catalog Number Codes: 06, 08, 12, 13, 14, 15, 16.

Seven variations of right-angle contacts are available. Designed for circuit board and panel applications, this option saves space when printed circuit boards are stacked closely together. It provides access to top connections in restricted spaces. Mount with angle brackets. (Catalog No. L92).



| Catalog No. Code | A in. | B in. |
|------------------|-------|-------|
| 06* | 0.46 | 0.11 |
| 08* | 0.75 | 0.11 |
| 12 | 0.21 | 0.65 |
| 13 | 0.36 | 0.50 |
| 14* | 0.41 | 0.16 |
| 15 | 0.51 | 0.35 |
| 16* | 0.32 | 0.25 |

*Not available with turret base

Wire Wrap

Catalog Number Code: 07. Longer than extended circuit board terminals. Post alignment is compatible with tolerances required for automatic wire wrapping equipment. Post dimensions are compatible with standard wire wrapping bits.

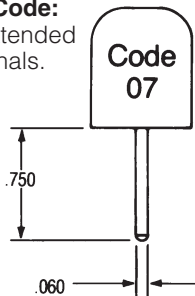

Top Hardware Options:

Binding Head Screws

In most applications, binding head screws will provide excellent wire retention because of exclusive wire locking tabs. These binding head screws are available in 3 materials identified by codes 01, 02, and 03.



Catalog Number Code:

- 01 Bright Zinc and Chromate Plated Steel
- 02 Stainless Steel
- 03 Nickel Plated Brass

Captive Clamp

For applications requiring extra security, captive clamps under the screw heads augment the locking tabs on each contact. Screws have a unique Phil-slot design accepting either Phillips-head or straight screwdriver. Code 02 screw is Bright Zinc and Chromate plated steel. Code 09 screw is Nickel plated Brass.



Catalog Number Code:

- 02 Bright Zinc and Chromate Plated Steel
- 09 Nickel Plated Brass

Catalog Number Codes: 20 through 56.

A complete selection of .187" and .250" quick-connect blades are available for connecting wire terminated with female quick connects. Single- and double-sided types in flat, 45° and 90° angle bends can be supplied. Material is brass with tin plating. All blades supplied with 01 screws. Various quick-connects can be combined.

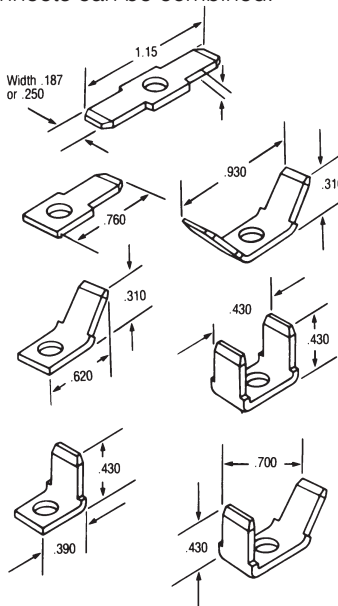

Solder Tabs

Catalog Number Code: 80. Single-sided, slotted solder tabs are available for making wrapped solder connections on the top side of SSBs.

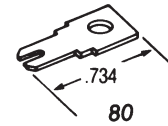

Circuit Identification Options:

Catalog Number Codes: 11 through 16.

SSB blocks may be ordered with circuit identification numbers in white on the molding in six different variations. Custom markings are available on special order.

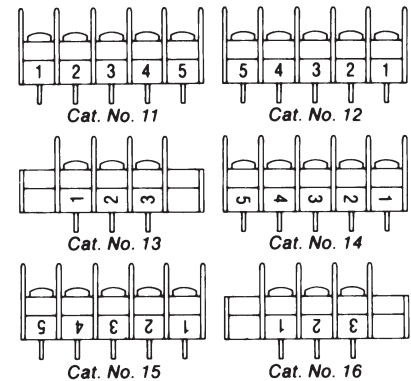

Molding Material Options:

The standard SSB molding material is UL94V-2 polypropylene. Consult Technical Support for other materials available on special order.

Molding Color Options:

SSB blocks are stocked in black. Consult Technical Support for availability of other colors.

Double-Row, Dual-Barrier Strips

Product Facts

- Double-row, dual barrier strips for wire-to-wire applications. These parts also allow end users to complete the wiring to a separate screw without disturbing the factory wiring.
- Available with either binding head screws or wire clamp
- Increased current-carrying capability

Applications

- Industrial Controls
- Test Equipment
- HVAC
- Power Supplies
- Traffic Signals
- Telecom

Key Features

- Closed bottom design allows for mounting direct to sheet metal panel
- Molded to length
- Accessories such as Quick-Connect Tabs and Jumpers available
- Wire-to-wire termination:
 - .374 [9.5] centerline:
Up to 30 positions
 - .433 [11.0] centerline:
Up to 26 positions
 - .437 [11.1] centerline:
Up to 26 positions
 - .563 [14.3] centerline:
Up to 18 positions
- RoHS Compliant



Note: All part numbers are RoHS Compliant.

Double-Row, Dual-Barrier Strips (Continued)

.374 [9.5] Centerline

Material & Finish

Insulator Body—UL94V-0, thermoplastic, black

Terminals—Brass, tin plated

Screw—#6-32 steel, nickel plated

Mechanical Properties

Screw Torque—12 in-lb

Electrical Properties

Current Rating—20 A, 300 VAC

Wire Range—12-22 AWG

Withstanding Voltage—2000 VAC min.

Environmental Properties

Operating Temperature—
-40°F to +221°F [-40°C to +120°C]

Hardware Options

J6140—Spade jumper, see page 177

J6240—Flanged spade jumper, see page 177

J6340—Ring tongue jumper, see page 177

J6—Spade jumper, see page 177



| No. of Positions | Dimension | | Part Numbers | |
|------------------|---------------|---------------|-----------------------|---------------------|
| | L | S | w/Binding Head Screws | w/Wire Clamp Screws |
| 2 | 1.42 [036.2] | 1.13 [028.7] | 1546306-2 | 1546307-2 |
| 3 | 1.80 [045.7] | 1.50 [038.2] | 1546306-3 | 1546307-3 |
| 4 | 2.17 [055.2] | 1.88 [047.7] | 1546306-4 | 1546307-4 |
| 5 | 2.55 [064.7] | 2.25 [057.2] | 1546306-5 | 1546307-5 |
| 6 | 2.92 [074.2] | 2.63 [066.7] | 1546306-6 | 1546307-6 |
| 7 | 3.30 [083.7] | 3.00 [076.2] | 1546306-7 | 1546307-7 |
| 8 | 3.67 [093.2] | 3.37 [085.7] | 1546306-8 | 1546307-8 |
| 9 | 4.05 [103.0] | 3.75 [095.2] | 1546306-9 | 1546307-9 |
| 10 | 4.41 [112.0] | 4.13 [105.0] | 1-1546306-0 | 1-1546307-0 |
| 11 | 4.80 [122.0] | 4.49 [114.0] | 1-1546306-1 | 1-1546307-1 |
| 12 | 5.16 [131.0] | 4.88 [124.0] | 1-1546306-2 | 1-1546307-2 |
| 13 | 5.55 [141.0] | 5.24 [133.0] | 1-1546306-3 | 1-1546307-3 |
| 14 | 5.91 [150.0] | 5.63 [143.0] | 1-1546306-4 | 1-1546307-4 |
| 15 | 6.30 [160.0] | 5.98 [152.0] | 1-1546306-5 | 1-1546307-5 |
| 16 | 6.65 [169.0] | 6.38 [162.0] | 1-1546306-6 | 1-1546307-6 |
| 17 | 7.05 [179.0] | 6.73 [171.0] | 1-1546306-7 | 1-1546307-7 |
| 18 | 7.40 [188.0] | 7.13 [181.0] | 1-1546306-8 | 1-1546307-8 |
| 19 | 7.79 [198.0] | 7.48 [190.0] | 1-1546306-9 | 1-1546307-9 |
| 20 | 8.15 [207.0] | 7.87 [200.0] | 2-1546306-0 | 2-1546307-0 |
| 21 | 8.54 [217.0] | 8.23 [209.0] | 2-1546306-1 | 2-1546307-1 |
| 22 | 8.90 [226.0] | 8.62 [219.0] | 2-1546306-2 | 2-1546307-2 |
| 23 | 9.29 [236.0] | 8.98 [228.0] | 2-1546306-3 | 2-1546307-3 |
| 24 | 9.65 [245.0] | 9.37 [238.0] | 2-1546306-4 | 2-1546307-4 |
| 25 | 10.04 [255.0] | 9.72 [247.0] | 2-1546306-5 | 2-1546307-5 |
| 26 | 10.39 [264.0] | 10.12 [257.0] | 2-1546306-6 | 2-1546307-6 |
| 27 | 10.79 [274.0] | 10.47 [266.0] | 2-1546306-7 | 2-1546307-7 |
| 28 | 11.14 [283.0] | 10.87 [276.0] | 2-1546306-8 | 2-1546307-8 |
| 29 | 11.54 [293.0] | 11.22 [285.0] | 2-1546306-9 | 2-1546307-9 |
| 30 | 11.89 [302.0] | 11.61 [295.0] | 3-1546306-0 | 3-1546307-0 |

Note: All part numbers are RoHS Compliant.

Double-Row, Dual-Barrier Strips (Continued)

.433 [11.0] Centerlines

Material & Finish

Insulator Body—UL94V-0, thermoplastic, black

Terminals—Brass, tin plated

Screw—#6-32 steel, nickel plated

Mechanical Properties

Screw Torque—12 in-lb

Electrical Properties

Current Rating—20 A, 300 VAC

Wire Range—14-22 AWG

Withstanding Voltage—2000 VAC min.

Environmental Properties

Operating Temperature—
-40°F to +221°F [-40°C to +120°C]



| No. of Positions | Dimension | | Part Numbers | |
|------------------|---------------|----------------|-----------------------|---------------------|
| | L | S | w/Binding Head Screws | w/Wire Clamp Screws |
| 2 | 1.65 [41.8] | 1.264 [32.1] | 1546481-2 | 1546477-2 |
| 3 | 2.08 [52.8] | 1.697 [43.1] | 1546481-3 | 1546477-3 |
| 4 | 2.51 [63.8] | 2.130 [54.1] | 1546481-4 | 1546477-4 |
| 5 | 2.94 [74.8] | 2.563 [65.1] | 1546481-5 | 1546477-5 |
| 6 | 3.38 [85.8] | 2.996 [76.1] | 1546481-6 | 1546477-6 |
| 7 | 3.81 [96.8] | 3.429 [87.1] | 1546481-7 | 1546477-7 |
| 8 | 4.24 [107.8] | 3.862 [98.1] | 1546481-8 | 1546477-8 |
| 9 | 4.68 [118.8] | 4.295 [109.1] | 1546481-9 | 1546477-9 |
| 10 | 5.11 [129.8] | 4.728 [120.1] | 1-1546481-0 | 1-1546477-0 |
| 11 | 5.54 [140.8] | 5.161 [131.1] | 1-1546481-1 | 1-1546477-1 |
| 12 | 5.98 [151.8] | 5.594 [142.1] | 1-1546481-2 | 1-1546477-2 |
| 13 | 6.41 [162.8] | 6.028 [153.1] | 1-1546481-3 | 1-1546477-3 |
| 14 | 6.84 [173.8] | 6.461 [164.1] | 1-1546481-4 | 1-1546477-4 |
| 15 | 7.27 [184.8] | 6.894 [175.1] | 1-1546481-5 | 1-1546477-5 |
| 16 | 7.71 [195.8] | 7.327 [186.1] | 1-1546481-6 | 1-1546477-6 |
| 17 | 8.14 [206.8] | 7.760 [197.1] | 1-1546481-7 | 1-1546477-7 |
| 18 | 8.57 [217.8] | 8.193 [208.1] | 1-1546481-8 | 1-1546477-8 |
| 19 | 9.01 [228.8] | 8.626 [219.1] | 1-1546481-9 | 1-1546477-9 |
| 20 | 9.44 [239.8] | 9.059 [230.1] | 2-1546481-0 | 2-1546477-0 |
| 21 | 9.87 [250.8] | 9.492 [241.1] | 2-1546481-1 | 2-1546477-1 |
| 22 | 10.31 [261.8] | 9.925 [252.1] | 2-1546481-2 | 2-1546477-2 |
| 23 | 10.74 [272.8] | 10.358 [263.1] | 2-1546481-3 | 2-1546477-3 |
| 24 | 11.17 [283.8] | 10.791 [274.1] | 2-1546481-4 | 2-1546477-4 |
| 25 | 11.61 [294.8] | 11.224 [285.1] | 2-1546481-5 | 2-1546477-5 |
| 26 | 12.04 [305.8] | 11.657 [296.1] | 2-1546481-6 | 2-1546477-6 |



Note: All part numbers are RoHS Compliant.

Double-Row, Dual-Barrier Strips (Continued)

.437 [11.1] Centerlines

Material & Finish

Insulator Body—UL94V-0, thermoplastic, black

Terminals—Brass, tin plated

Screw—#6-32 steel, nickel plated

Mechanical Properties

Screw Torque—12 in-lb

Electrical Properties

Current Rating—20 A, 300 VAC

Wire Range—14-22 AWG

Withstanding Voltage—2000 VAC min.

Environmental Properties

Operating Temperature—-40°F to +221°F [-40°C to +120°C]

Hardware Options

1776110-x—Single-sided Quick Connects, see page 176

1776057-x—Two-sided Quick Connects, see page 176

J7—Spade jumper, see page 177

J7140—Spade jumper, see page 177

J7240—Flanged jumper, see page 177

J7340—Ring tongue jumper, see page 177

J76—Over-the-barrier jumper, see page 177

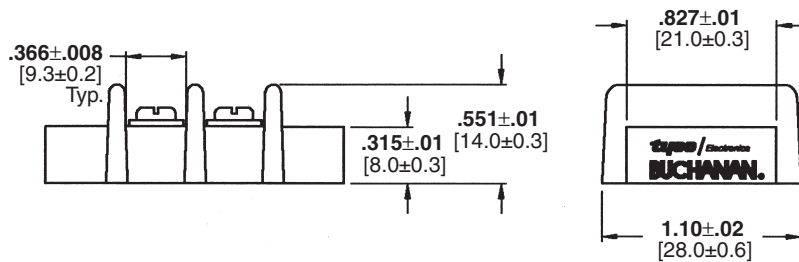
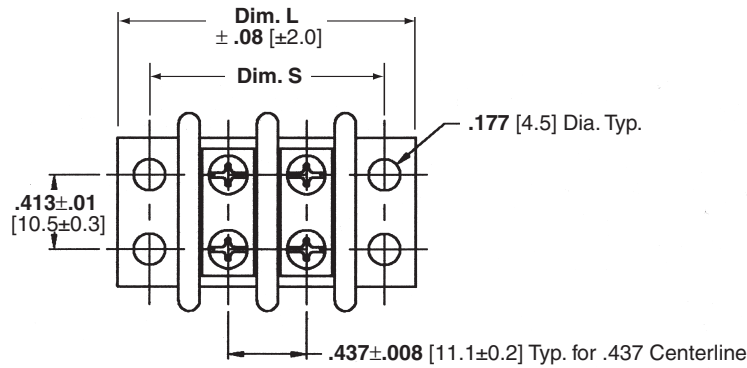

| No. of Positions | Dimension | | Part Numbers | |
|------------------|---------------|----------------|-----------------------|---------------------|
| | L | S | w/Binding Head Screws | w/Wire Clamp Screws |
| 2 | 1.62 [41.2] | 1.264 [32.1] | 1546670-2 | 1546671-2 |
| 3 | 2.06 [52.3] | 1.697 [43.1] | 1546670-3 | 1546671-3 |
| 4 | 2.50 [63.4] | 2.130 [54.1] | 1546670-4 | 1546671-4 |
| 5 | 2.93 [74.5] | 2.563 [65.1] | 1546670-5 | 1546671-5 |
| 6 | 3.37 [85.6] | 2.996 [76.1] | 1546670-6 | 1546671-6 |
| 7 | 3.81 [96.7] | 3.429 [87.1] | 1546670-7 | 1546671-7 |
| 8 | 4.24 [107.8] | 3.862 [98.1] | 1546670-8 | 1546671-8 |
| 9 | 4.68 [118.9] | 4.295 [109.1] | 1546670-9 | 1546671-9 |
| 10 | 5.12 [130.0] | 4.728 [120.1] | 1-1546670-0 | 1-1546671-0 |
| 11 | 5.55 [141.1] | 5.161 [131.1] | 1-1546670-1 | 1-1546671-1 |
| 12 | 5.99 [152.2] | 5.594 [142.1] | 1-1546670-2 | 1-1546671-2 |
| 13 | 6.43 [163.3] | 6.028 [153.1] | 1-1546670-3 | 1-1546671-3 |
| 14 | 6.87 [174.4] | 6.461 [164.1] | 1-1546670-4 | 1-1546671-4 |
| 15 | 7.30 [185.5] | 6.894 [175.1] | 1-1546670-5 | 1-1546671-5 |
| 16 | 7.74 [196.6] | 7.327 [186.1] | 1-1546670-6 | 1-1546671-6 |
| 17 | 8.18 [207.7] | 7.760 [197.1] | 1-1546670-7 | 1-1546671-7 |
| 18 | 8.61 [218.8] | 8.193 [208.1] | 1-1546670-8 | 1-1546671-8 |
| 19 | 9.05 [229.9] | 8.626 [219.1] | 1-1546670-9 | 1-1546671-9 |
| 20 | 9.49 [241.0] | 9.059 [230.1] | 2-1546670-0 | 2-1546671-0 |
| 21 | 9.93 [252.1] | 9.492 [241.1] | 2-1546670-1 | 2-1546671-1 |
| 22 | 10.36 [263.2] | 9.925 [252.1] | 2-1546670-2 | 2-1546671-2 |
| 23 | 10.80 [274.3] | 10.358 [263.1] | 2-1546670-3 | 2-1546671-3 |
| 24 | 11.24 [285.4] | 10.791 [274.1] | 2-1546670-4 | 2-1546671-4 |
| 25 | 11.67 [296.5] | 11.224 [285.1] | 2-1546670-5 | 2-1546671-5 |
| 26 | 12.11 [307.6] | 11.657 [296.1] | 2-1546670-6 | 2-1546671-6 |

Note: All part numbers are RoHS Compliant.

Double-Row, Dual-Barrier Strips (Continued)

.563 [14.3] Centerline

Material & Finish

Insulator Body—UL94V-0, thermoplastic, black

Terminals—Brass, tin plated

Screw—M4.0 steel, nickel plated

Mechanical Properties

Screw Torque—16 in-lb

Electrical Properties

Current Rating—30 A, 300 VAC

Wire Range—10-22 AWG

Withstanding Voltage—2000 VAC min.

Environmental Properties

Operating Temperature—-40°F to +284°F [-40°C to +140°C]

Hardware Options

1776174-x—Single-sided Quick Connects, see page 176

1776173-x—Two-sided Quick Connects, see page 176



| No. of Positions | Dimension | | Part Numbers | |
|------------------|---------------|---------------|---------------------|-----------------------|
| | L | S | w/Wire Clamp Screws | w/Binding Head Screws |
| 2 | 2.13 [54.0] | 1.69 [42.9] | 1546311-2 | 1546310-2 |
| 3 | 2.69 [68.3] | 2.25 [57.2] | 1546311-3 | 1546310-3 |
| 4 | 3.25 [82.6] | 2.81 [71.5] | 1546311-4 | 1546310-4 |
| 5 | 3.81 [96.9] | 3.38 [85.8] | 1546311-5 | 1546310-5 |
| 6 | 4.38 [111.2] | 3.94 [100.1] | 1546311-6 | 1546310-6 |
| 7 | 4.94 [125.5] | 4.50 [114.4] | 1546311-7 | 1546310-7 |
| 8 | 5.50 [139.8] | 5.07 [128.7] | 1546311-8 | 1546310-8 |
| 9 | 6.08 [154.1] | 5.63 [143.0] | 1546311-9 | 1546310-9 |
| 10 | 6.63 [168.4] | 6.19 [157.3] | 1-1546311-0 | 1-1546310-0 |
| 11 | 7.19 [182.7] | 6.76 [171.6] | 1-1546311-1 | 1-1546310-1 |
| 12 | 7.75 [197.0] | 7.32 [185.9] | 1-1546311-2 | 1-1546310-2 |
| 13 | 8.32 [211.3] | 7.88 [200.2] | 1-1546311-3 | 1-1546310-3 |
| 14 | 8.88 [225.6] | 8.44 [214.5] | 1-1546311-4 | 1-1546310-4 |
| 15 | 9.44 [239.9] | 9.01 [228.8] | 1-1546311-5 | 1-1546310-5 |
| 16 | 10.02 [254.5] | 9.57 [243.1] | 1-1546311-6 | 1-1546310-6 |
| 17 | 10.57 [268.5] | 10.13 [257.4] | 1-1546311-7 | 1-1546311-7 |
| 18 | 11.13 [282.8] | 10.70 [271.7] | 1-1546311-8 | 1-1546310-8 |

Note: All part numbers are RoHS Compliant.

Double-Row, Dual-Barrier Strips w/o Washer

.563 [14.3] Centerline

Material & Finish

Insulator Body—UL94V-0, thermoplastic, black

Terminals—Brass, tin plated

Screw—M4.0 steel, nickel plated

Mechanical Properties

Screw Torque—14 in-lb

Electrical Properties

Current Rating—30 A, 600 VAC

Wire Range—10-22 AWG

Withstanding Voltage—2000 VAC min.

Environmental Properties

Operating Temperature—-40°F to +120°F [-40°C to +49°C]

Hardware Options

1776174-x—Single-sided Quick Connects, see page 176

1776173-x—Two-sided Quick Connects, see page 176



| No. of Positions | Dimension | | Part Numbers | |
|------------------|---------------|---------------|---------------------|-----------------------|
| | L | S | w/Wire Clamp Screws | w/Binding Head Screws |
| 2 | 2.13 [54.0] | 1.69 [42.9] | 1776544-2 | 1986158-2 |
| 3 | 2.69 [68.3] | 2.25 [57.2] | 1776544-3 | 1986158-3 |
| 4 | 3.25 [82.6] | 2.81 [71.5] | 1776544-4 | 1986158-4 |
| 5 | 3.81 [96.9] | 3.38 [85.8] | 1776544-5 | 1986158-5 |
| 6 | 4.38 [111.2] | 3.94 [100.1] | 1776544-6 | 1986158-6 |
| 7 | 4.94 [125.5] | 4.50 [114.4] | 1776544-7 | 1986158-7 |
| 8 | 5.50 [139.8] | 5.07 [128.7] | 1776544-8 | 1986158-8 |
| 9 | 6.08 [154.1] | 5.63 [143.0] | 1776544-9 | 1986158-9 |
| 10 | 6.63 [168.4] | 6.19 [157.3] | 1-176544-0 | 1-1986158-0 |
| 11 | 7.19 [182.7] | 6.76 [171.6] | 1-176544-1 | 1-1986158-1 |
| 12 | 7.75 [197.0] | 7.32 [185.9] | 1-176544-2 | 1-1986158-2 |
| 13 | 8.32 [211.3] | 7.88 [200.2] | 1-176544-3 | 1-1986158-3 |
| 14 | 8.88 [225.6] | 8.44 [214.5] | 1-176544-4 | 1-1986158-4 |
| 15 | 9.44 [239.9] | 9.01 [228.8] | 1-176544-5 | 1-1986158-5 |
| 16 | 10.02 [254.5] | 9.57 [243.1] | 1-176544-6 | 1-1986158-6 |
| 17 | 10.57 [268.5] | 10.13 [257.4] | 1-176544-7 | 1-1986158-7 |
| 18 | 11.13 [282.8] | 10.70 [271.7] | 1-176544-8 | 1-1986158-8 |

Barrier Strip Sockets

Mateability for the socket line is given below:

| Socket Series | Connector Series |
|---------------|------------------|
| USB | RSB3, SSB3 |
| RSB6B | RSB6 |

Product Facts

- n End-to-end mounting of USB sockets maintain circuit spacing: Two 12-circuit USB sockets can mate with one 24-circuit SSB3 or RSB3.
- n Secure mating with built-in locking arms



This unique plug-in socket line allows quick connection of circuits simultaneously without the use of tools.

They are designed to be wave-soldered to a PC board, after which the connector is plugged into the socket.

Note: All part numbers are RoHS Compliant.

0.325" [8.26] Pitch, Series USB Socket (for Series RSB3 and SSB3)

USB3B08S & SSB3FP080202

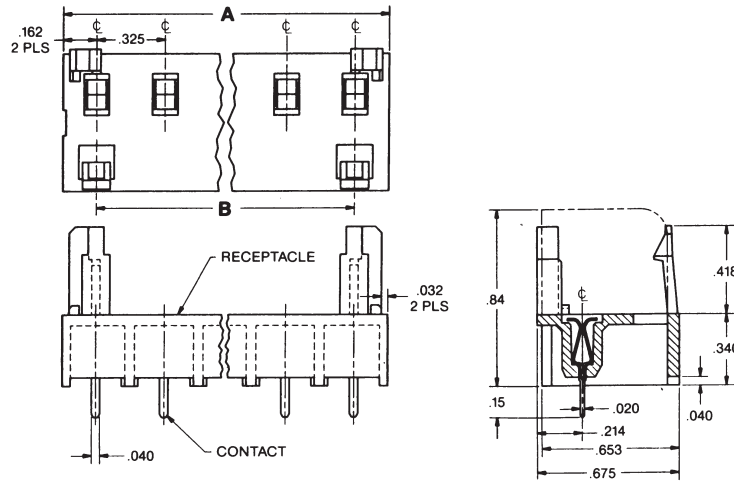

Material & Finish

Housing Material—Polyamide, Type 6/6

Flammability—UL94V-2

Color—Black

Terminals Contact—Copper alloy, bright tin plating

Pin—Copper alloy, bright tin plating

Mechanical Properties

Pitch (Terminal Spacing)—0.325" [8.26]

Recommended PCB Hole Dia.—.055" [1.40]

Pullout Force—5-7 lbs.

Electrical Properties

Ratings—UL Class B 10 Amps, 300V
CSA Type B 15 Amps, 300V
CSA Type D 10 Amps, 300V

Dielectric Withstand—3500V

Environmental Properties

Operating Temperature Range—-60°C to +105°C [-76°F to +221°F]



Recommended PCB Hole Pattern

| No. of Circuits | Dimensions | | Dual-Barrier Mating Strip Catalog Number | Tri-Barrier Mating Strip Catalog Number | Catalog Number |
|-----------------|------------|-------|--|---|----------------|
| | A | B | | | |
| 2 | 0.650 | 0.325 | SSB3FP0202... | RSB3VP0212... | USB3B02S |
| 3 | 0.975 | 0.650 | SSB3FP0302... | RSB3VP0312... | USB3B03S |
| 4 | 1.300 | 0.975 | SSB3FP0402... | RSB3VP0412... | USB3B04S |
| 5 | 1.625 | 1.300 | SSB3FP0502... | RSB3VP0512... | USB3B05S |
| 6 | 1.950 | 1.625 | SSB3FP0602... | RSB3VP0612... | USB3B06S |
| 7 | 2.275 | 1.950 | SSB3FP0702... | RSB3VP0712... | USB3B07S |
| 8 | 2.600 | 2.275 | SSB3FP0802... | RSB3VP0812... | USB3B08S |
| 9 | 2.925 | 2.600 | SSB3FP0902... | RSB3VP0912... | USB3B09S |
| 10 | 3.250 | 2.925 | SSB3FP1002... | RSB3VP1012... | USB3B10S |
| 11 | 3.575 | 3.250 | SSB3FP1102... | RSB3VP1112... | USB3B11S |
| 12 | 3.900 | 3.575 | SSB3FP1202... | RSB3VP1212... | USB3B12S |
| 13 | 4.225 | 3.900 | SSB3FP1302... | RSB3VP1312... | USB3B13S |
| 14 | 4.550 | 4.225 | SSB3FP1402... | RSB3VP1412... | USB3B14S |

Note: See page 165 to complete mating Tri-Barrier Strip Catalog Number.
See page 169 to complete mating Dual-Barrier Strip Catalog Number.



Note: All part numbers are RoHS Compliant.

0.375" [9.53] Pitch, Series RSB6B Socket (for Series RSB6 Tri-Barrier)

RSB6B06S



Material & Finish

- Housing Material**—Polyamide
- Flammability**—UL94V-2
- Color**—Black
- Terminals**—Copper alloy, bright tin plating
- Pin**—Copper alloy, bright tin plating

Mechanical Properties

- Pitch (Terminal Spacing)**—
.375 in [9.53]
- Recommended PCB Hole Dia.**—
.062" [1.57]

Electrical Properties

- Ratings**—UL Class B 20 Amps, 300V
CSA Type B 10 Amps, 300V
CSA Type D 5 Amps, 600V
- Dielectric Withstand**—3500V

Environmental Properties

- Operating Temperature Range**—
-60°C to +105°C [-76°F to +221°F]

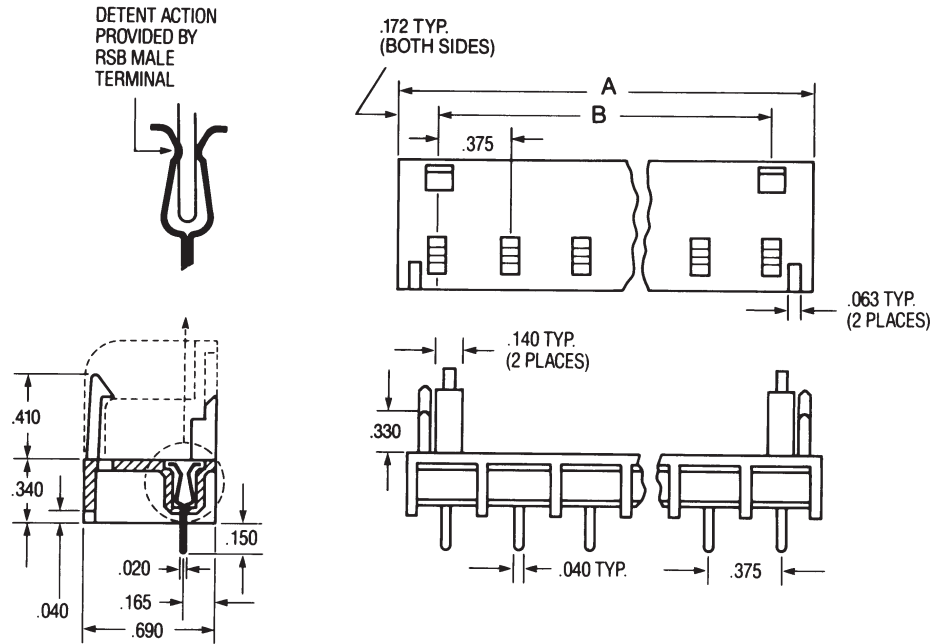

Recommended PCB Hole Pattern

| No. of Circuits | Dimensions | | Catalog Number |
|-----------------|------------|-------|----------------|
| | A | B | |
| 02 | 0.720 | 0.375 | RSB6B02S |
| 03 | 1.094 | 0.750 | RSB6B03S |
| 04 | 1.469 | 1.125 | RSB6B04S |
| 05 | 1.844 | 1.500 | RSB6B05S |
| 06 | 2.219 | 1.875 | RSB6B06S |
| 07 | 2.594 | 2.250 | RSB6B07S |
| 08 | 2.869 | 2.625 | RSB6B08S |
| 09 | 3.244 | 3.000 | RSB6B09S |
| 10 | 3.720 | 3.375 | RSB6B10S |

Note: RSB6 Tri-Barrier Blocks should be ordered with Number 12 Terminal Style (printed circuit pin, V mounting) when used in combination with this plug-in socket. See page 172 for ordering information.

Note: All part numbers are RoHS Compliant.

0.325" [8.26] Pitch, Series RSB3

RSB3VP061202



Material & Finish

Housing Material—Polypropylene

Flammability—UL94V-2

Color—Black

Terminals—Brass w/bright Tin plating

Screws—Steel w/Zinc + Chromate plating

Mechanical Properties

Pitch (Terminal Spacing)—

.325 in [8.26]

Screw Size—6-32

Recommended PCB Hole Dia.—0.062"

Wire Strip Length— .31 in [7.87]

Recommended Tightening Torque—9 in-lbs.

Recommended Screwdrivers—Stanley 1006-4, Sears Craftsman 41581, Any #2 Phillips-Head

Wire Lug Width (Max.)— .265 in [6.73]

Electrical Properties

Maximum Current—15A

Operating Voltage—300V

Wire Range—#14-26 AWG

Dielectric Withstand—4000V

Environmental Properties

Operating Temperature Range— -60°C to +105°C [-76°F to +221°F]

For mating socket, see pg. 162.

Computing Barrier Block Lengths

Direct Mounting—Use C1 and L1 for Mounting Option "P".

End Position Mounting—Use C2 and L2 for Mounting Option "M".

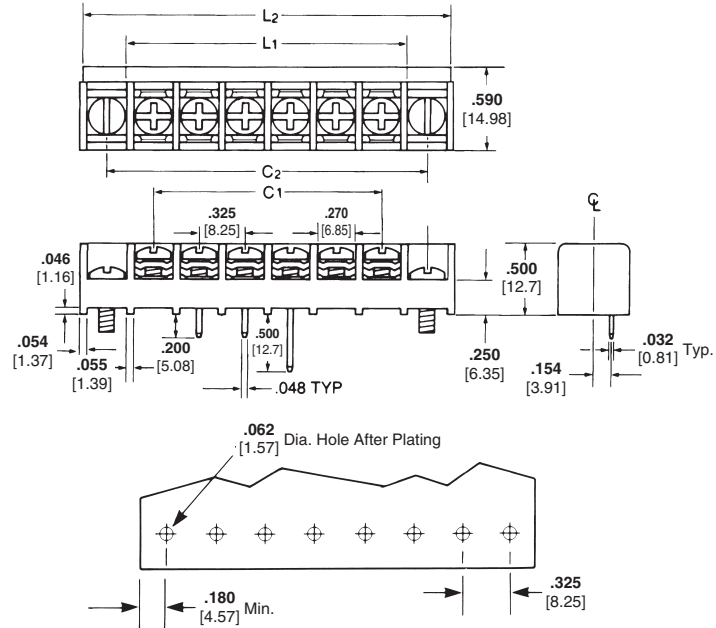

Dimensions

| Circuits (not positions) | C1 in. | L1* in. | C2 in. | L2* in. |
|--------------------------|--------|---------|--------|---------|
| 02 | 0.325 | 0.704 | 0.975 | 1.354 |
| 03 | 0.650 | 1.029 | 1.300 | 1.679 |
| 04 | 0.975 | 1.354 | 1.625 | 2.004 |
| 05 | 1.300 | 1.679 | 1.950 | 2.329 |
| 06 | 1.625 | 2.004 | 2.275 | 2.654 |
| 07 | 1.950 | 2.329 | 2.600 | 2.979 |
| 08 | 2.275 | 2.654 | 2.925 | 3.304 |
| 09 | 2.600 | 2.797 | 3.250 | 3.629 |
| 10 | 2.925 | 3.304 | 3.575 | 3.954 |
| 11 | 3.250 | 3.629 | 3.900 | 4.279 |
| 12 | 3.575 | 3.954 | 4.225 | 4.604 |
| 13 | 3.900 | 4.279 | 4.550 | 4.929 |
| 14 | 4.225 | 4.604 | 4.875 | 5.254 |
| 16 | 4.875 | 5.254 | 5.525 | 5.904 |
| 17 | 5.200 | 5.579 | 5.850 | 6.229 |
| 18 | 5.525 | 5.904 | 6.175 | 7.554 |
| 19 | 5.850 | 6.229 | 6.500 | 6.879 |
| 20 | 6.175 | 6.554 | 6.825 | 7.204 |
| 21 | 6.500 | 6.879 | 7.150 | 7.529 |
| 22 | 6.825 | 7.204 | 7.475 | 7.854 |
| 23 | 7.150 | 7.529 | 7.800 | 8.179 |
| 24 | 7.475 | 7.854 | 8.125 | 8.504 |
| 25 | 7.800 | 8.179 | 8.450 | 8.829 |
| 26 | 8.125 | 8.504 | 8.775 | 9.154 |
| 27 | 8.450 | 8.829 | 9.100 | 9.479 |
| 28 | 8.775 | 9.154 | 9.425 | 9.804 |
| 29 | 9.100 | 9.479 | 9.750 | 10.129 |
| 30 | 9.425 | 9.804 | 10.075 | 10.454 |
| 31 | 9.750 | 10.129 | 10.400 | 10.779 |
| 32 | 10.075 | 10.454 | 10.725 | 11.104 |
| 33 | 10.400 | 10.779 | 11.050 | 11.429 |
| 34 | 10.725 | 11.104 | 11.357 | 11.754 |
| 35 | 11.050 | 11.429 | — | — |
| 36 | 11.357 | 11.754 | — | — |

*L2 and L1 are based on molded-to-length strips.



Note: All part numbers are RoHS Compliant.

0.325" [8.26] Pitch, Series RSB3 (Continued)

Ordering Information

RSB 3 V P 06 12 02 11
A B C D E F G H

A Single Screw Tri-Barrier Strip RSB

B Contact Spacing (Center-to-Center)
 3=.325 in.

C Mounting Position
 V=Vertical Mounting

D End Contact Mounting Options
M=End Position Mounting: open end positions with barriers.
P=Direct Mounting: all positions filled with contacts, with barriers

E No. of Circuits (Not Positions)
02 through **34** for M Option
02 through **36** for P Option

F Terminal Style
12=Printed Circuit Pin for use with USB3 Series Socket
15=Superseded by 4 PCR per page 125
17=Superseded by 4WWV, page 125

G Top Hardware Options
01=Bright zinc and chromate plated steel binding-head screw

02=Bright zinc and chromate plated steel screw and captive clamp – Do not order in combination with other top hardware.

Quick-Connect Blades
 (supplied with 01 screw)

| .110 wide | | .187 wide | |
|-------------|-----|---|--|
| x.020 thick | | x.020 thick | |
| 13 | 73= |  | |
| 14 | 74= |  | |
| 15 | 75= |  | |

Catalog Number Codes: 13 through 15 and 73 through 75. A complete selection of .187" and .110" quick-connect blades for connecting wire terminated with female quick connects. Single-sided types in flat, 45° and 90° angle bends can be supplied. Material is brass with tin plating. All blades supplied with 01 screws. Various quick-connects can be combined.



H Circuit Identification Options
 Catalog Number Codes: 11 through 18 and 21 through 28. RSB3 blocks may be ordered with white circuit identification numbers on the molding in 16 variations. Custom markings available on special order.



For mating socket, see pg. 162.



Barrier Strips
2

Note: All part numbers are RoHS Compliant.

0.325" [8.26] Pitch, Series RSB3 (Continued)

Mounting Position

Vertical Mounting

Catalog Letter Code: V. Used where direct top-to-bottom feed-through is required with no need for circuit isolation on the bottom side. The most common example of this is printed circuit board mounting.



End Contact Mounting Options

End Position Mounting

Catalog Letter Code: M. Supplied without contact in end sections to allow installer to mount blocks with screws in end section holes. Base of block will support #6 mounting screws.



Direct Mounting

Catalog Letter Code: P. RSB3 may be solder-mounted using the bottom terminals themselves, as in the case of printed circuit board applications.



Terminal Style

Printed Circuit Pin

Catalog Number Code: 12. Designed specifically for use with our USB3 socket, page 162



Hardware Options

- 3C1xxx**—Safety cover, see page 175
- J3140**—Jumpers, see page 177
- 3L02**—Wire clamp screw, see page 178
- 3L01**—Binding head screw, see page 178



Note: All part numbers
are RoHS Compliant.

Engineering Notes

A large grid area for engineering notes, consisting of a uniform grid of small squares covering most of the page.

Note: All part numbers are RoHS Compliant.

0.325" [8.26] Pitch, Series SSB3

SSB3FP##0202

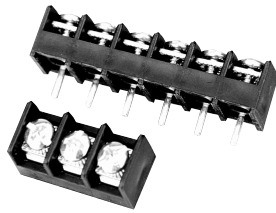

Material & Finish

- Housing Material**—Polypropylene
- Flammability**—UL94V-2
- Color**—Black
- Terminals**—Brass, bright acid tin over copper plating
- Screw**—Steel w/ Zinc + Chromate plating

Mechanical Properties

- Pitch (Terminal Spacing)**— .325" [8.26]
- Screw Size**—6-32
- Recommended PCB Hole Dia.**— .062" [1.57]
- Wire Strip Length**— .31" [7.87]
- Recommended Tightening Torque**—9 in.-lbs.
- Recommended Screwdrivers**— Stanley 1006-4, Sears Craftsman 41581, Any #2 Phillips Head.
- Wire Lug Width (Max.)**— .265" [6.73]

Electrical Properties

- Ratings**—UL Class B 20 Amps, 300V
UL Class C 20 Amps, 300V
UL Class D 10 Amps, 300V
CSA Type B 10 Amps, 300V
CSA Type D 10 Amps, 300V

- Wire Range**—#14-26 AWG
- Dielectric Withstand**—4500V

Environmental Properties

- Operating Temperature Range**— 60°C to +105°C [-76°F to +221°F]

Computing Barrier Block Lengths

- Direct Mounting**— Use C1 & L1 for Mounting Option "P".
- End Position Mounting**— Use C2 & L2 for Mounting Options "F" and "M".

For mating socket, see pg. 162.

Dimensions

| Circuits (not positions) | C1 in. | L1* in. | C2 in. | L2* in. |
|--------------------------|--------|---------|--------|---------|
| 02 | 0.325 | 0.704 | 0.975 | 1.354 |
| 03 | 0.650 | 1.029 | 1.300 | 1.679 |
| 04 | 0.975 | 1.354 | 1.625 | 2.004 |
| 05 | 1.300 | 1.679 | 1.950 | 2.329 |
| 06 | 1.625 | 2.004 | 2.275 | 2.654 |
| 07 | 1.950 | 2.329 | 2.600 | 2.979 |
| 08 | 2.275 | 2.654 | 2.925 | 3.304 |
| 09 | 2.600 | 2.979 | 3.250 | 3.629 |
| 10 | 2.925 | 3.304 | 3.575 | 3.954 |
| 11 | 3.250 | 3.629 | 3.900 | 4.279 |
| 12 | 3.575 | 3.954 | 4.225 | 4.604 |
| 13 | 3.900 | 4.279 | 4.550 | 4.929 |
| 14 | 4.225 | 4.604 | 4.875 | 5.254 |
| 15 | 4.550 | 4.949 | 5.200 | 5.579 |
| 16 | 4.875 | 5.254 | 5.525 | 5.579 |
| 17 | 5.200 | 5.579 | 5.850 | 6.229 |
| 18 | 5.525 | 5.904 | 6.175 | 7.554 |
| 19 | 5.850 | 6.229 | 6.500 | 6.879 |
| 20 | 6.2175 | 6.554 | 6.825 | 7.204 |
| 21 | 6.500 | 6.879 | 7.150 | 7.529 |
| 22 | 6.825 | 7.204 | 7.475 | 7.854 |
| 23 | 7.150 | 7.529 | 7.800 | 8.179 |
| 24 | 7.475 | 7.854 | 8.125 | 8.504 |
| 25 | 7.800 | 8.179 | 8.450 | 8.829 |
| 26 | 8.125 | 8.504 | 8.775 | 9.154 |
| 27 | 8.450 | 8.829 | 9.100 | 9.479 |
| 28 | 8.775 | 9.154 | 9.425 | 9.804 |
| 29 | 9.100 | 9.479 | 9.750 | 10.129 |
| 30 | 9.425 | 9.804 | 10.075 | 10.454 |
| 31 | 9.750 | 10.129 | 10.400 | 10.779 |
| 32 | 10.075 | 10.454 | 10.725 | 11.104 |
| 33 | 10.400 | 10.779 | 11.050 | 11.429 |
| 34 | 10.725 | 11.104 | 11.375 | 11.754 |
| 35 | 11.050 | 11.429 | — | — |
| 36 | 11.375 | 11.754 | — | — |



EC/98/003-01 12241/CL LR25557 E63810

Note: All part numbers are RoHS Compliant.

0.325" [8.26] Pitch, Series SSB3 (Continued)

Ordering Information

SSB 3 F P 06 02 02 Suffix
A B C D E F G H

A Single Screw Dual-Barrier Strip SSB

B Contact Spacing
(Center-to-Center)
3=.325 in.

C Base
F=Raised Base

D Mounting Options
F= Open end positions without end barriers
M= Open end positions with end barriers
P= All positions filled with contacts, with end barriers

E No. of Circuits (Not Positions)
02 through 36

F Terminal Style
02= Printed Circuit Pin
04= Extended Circuit Board
11= Right-Angle Bend .18 x .12

G Top Hardware Options
01= Bright zinc and chromate plated steel binding-head screw



02= Bright zinc and chromate plated steel screw and captive clamp - Do not order in combination with other top hardware.



Quick-Connect Blades
(supplied with 01 screw)

| | .110 wide | .187 wide |
|--|-----------|-----------|
| | x.020 | x.020 |
| | thick | thick |
| | 10 | 70= |
| | 11 | 71= |
| | 12 | 72= |
| | 13 | 73= |
| | 14 | 74= |
| | 15 | 75= |

H Circuit Identification Options
Catalog Number Codes: 11 through 16. SSB blocks may be ordered with circuit identification numbers in white on the molding in six different variations. Custom markings are available on special order.

| | |
|----|------------|
| 11 | = 12345... |
| 12 | = ...54321 |
| 13 | = |
| 14 | = |
| 15 | = |
| 16 | = |

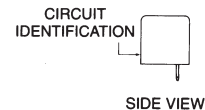
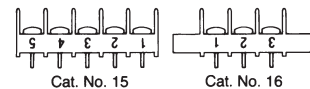
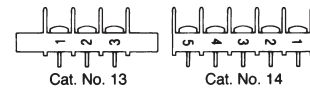
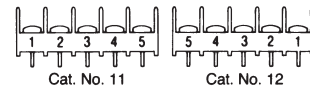

Hardware Options

- 3C1xxx**—Safety cover, see page 175
- J3140**—Jumpers, see page 177
- 3L02**—Wire clamp screw, see page 178
- 3L01**—Binding head screw, see page 178
- QC1x**—.110 Quick connects, see page 176
- QC7x**—.187 Quick connects, see page 176

For mating socket, see pg. 162.



Barrier Strips

2

Note: All part numbers are RoHS Compliant.

0.325" [8.26] Pitch, Series SSB3, Options

Base

Catalog Letter Code: F. Lends itself most readily to applications where direct top-to-bottom feed-through is required with no special requirement for circuit isolation on the bottom side. The most common example of this is printed circuit board mounting.



Mounting Options

End Position Mounting

Catalog Letter Code: M. Provides a printed circuit board mounting option with top-side wire entry.



End Position Mounting Without Barriers

Catalog Letter Code: F. Facilitates mounting-screw access when end sections are used for mounting.



Direct Mounting:

Catalog Letter Code: P. SSBs may be solder-mounted using the bottom terminals themselves, as in the case of printed circuit board applications.



Printed Circuit Pin:

Catalog Number Code: 02.

Designed specifically for mounting on .063" thick circuit board. Special, readily solderable plating permits good fillet development in automated soldering processes.

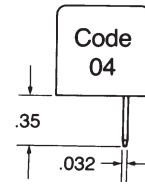

Extended Printed Circuit Pin:

Catalog Number Code: 04. Useful where extra length is needed, as in thicker printed circuit boards or single-wrap connections.

Quick Connects

Catalog Number Codes: 10 through 75.

A complete selection of .187" and .110" quick-connect blades are available for connecting wire terminated with female quick connects. Single- and double-sided types in flat, 45° and 90° angle bends can be supplied. Material is brass with tin plating. All blades supplied with O1 screws. Various quick-connects can be combined.

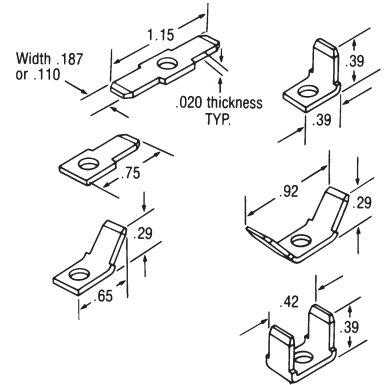

Top Hardware Options

Binding Head Screws

Catalog Number Code: 01. In most applications, binding head screws will provide excellent wire retention because of exclusive wire locking tabs. Screws are bright zinc and chromate plated steel.



Captive Clamp

Catalog Number Code: 02.

For applications requiring extra security, captive clamps under the screw heads augment the locking tabs on each contact. Screws have a unique Phil-slot design accepting either Phillips-head or straight screwdriver. Code 02 screw is bright zinc and chromate plated steel.



Note: All part numbers are RoHS Compliant.

0.375" [9.53] Pitch, Series RSB6

RSB6RP##1102

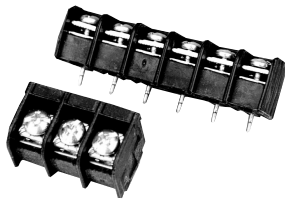

Material & Finish

Housing Material—Polypropylene

Flammability—UL94V-2

Color—Black

Terminals—Brass, bright acid tin over copper plating

Screw—Steel w/Zinc + Chromate plating

Mechanical Properties

Pitch (Terminal Spacing)—.375" [9.53]

Screw Size—6-32

Recommended PCB Hole Dia.—.062" [1.57]

Wire Strip Length—.38" [9.65]

Recommended Tightening Torque—12 in.-lbs.

Recommended Screwdrivers—Stanley 1006-4, Sears Craftsman 41581, Any #2 Phillips-Head

Wire Lug Width (Max.)—8.1mm [.320"]

Electrical Properties

Ratings—UL Class B 20 Amps, 300V
CSA Type C 15 Amps, 150V
CSA Type D 10 Amps, 300V

Wire Range—12-22 AWG

Dielectric Withstand—3500V

Environmental Properties

Operating Temperature Range—60°C to +105°C [-76°F to +221°F]

Computing RSB Block Lengths

Direct Mounting — Use C1 & L1 for VP, SP, RP mounting options

End Position Mounting — Use L2 & C2 for VM, SM, RM, VE, SE, RE mounting options

For mating socket, see pg. 163.

Hardware Options

J6—Jumpers, see page 177

L02—Wire clamp screw, steel, see page 178

L09—Wire clamp screw, brass, see page 178

L01—Binding head screw, see page 178

L04—Binding head screw, brass, see page 178

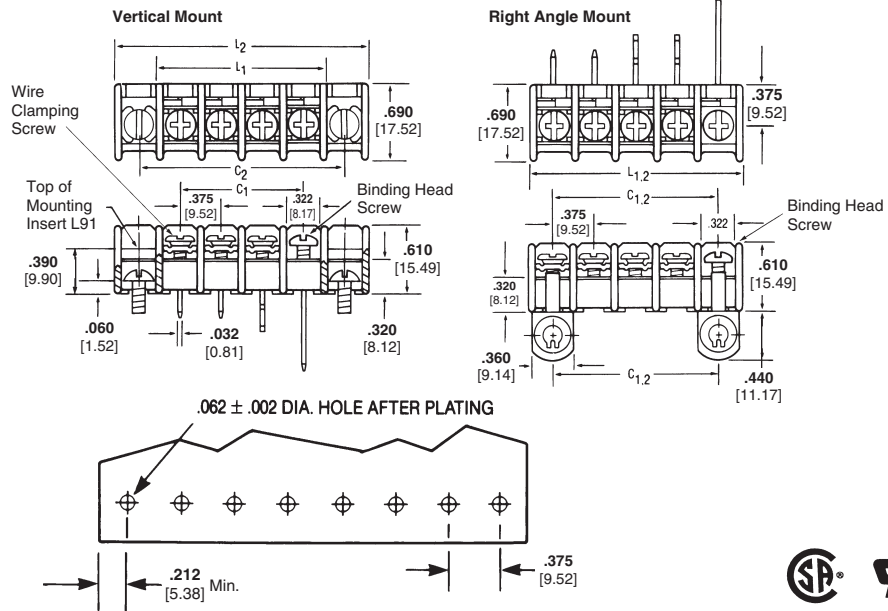

Dimensions

| Circuits (not positions) | C1 in. | L1* in. | C2 in. | L2* in. |
|--------------------------|--------|---------|--------|---------|
| 01 | — | — | 0.75 | 1.22 |
| 02 | 0.37 | 0.84 | 1.13 | 1.59 |
| 03 | 0.75 | 1.22 | 1.50 | 1.97 |
| 04 | 1.13 | 1.59 | 1.88 | 2.34 |
| 05 | 1.50 | 1.97 | 2.25 | 2.72 |
| 06 | 1.88 | 2.34 | 2.63 | 3.09 |
| 07 | 2.25 | 2.72 | 3.00 | 3.47 |
| 08 | 2.63 | 3.09 | 3.37 | 3.84 |
| 09 | 3.00 | 3.47 | 3.75 | 3.84 |
| 10 | 3.37 | 3.84 | 4.13 | 4.59 |
| 11 | 3.75 | 4.22 | 4.50 | 4.97 |
| 12 | 4.13 | 4.59 | 4.88 | 5.34 |
| 13 | 4.50 | 4.97 | 5.25 | 5.72 |
| 14 | 4.88 | 5.34 | 5.63 | 6.09 |
| 15 | 5.25 | 5.72 | 6.00 | 6.47 |
| 16 | 5.63 | 6.09 | 6.38 | 6.84 |
| 17 | 6.00 | 6.47 | 6.75 | 7.22 |
| 18 | 6.38 | 6.84 | 7.13 | 7.59 |
| 19 | 6.75 | 7.22 | 7.50 | 7.97 |
| 20 | 7.13 | 7.59 | 7.88 | 8.34 |
| 21 | 7.50 | 7.97 | 8.25 | 8.72 |
| 22 | 7.88 | 8.34 | 8.63 | 9.09 |
| 23 | 8.25 | 8.72 | 9.00 | 9.47 |
| 24 | 8.63 | 9.09 | 9.75 | 9.84 |
| 25 | 9.00 | 9.47 | 9.75 | 10.22 |
| 26 | 9.38 | 9.84 | 10.13 | 10.59 |
| 27 | 9.75 | 10.22 | 10.50 | 10.97 |
| 28 | 10.13 | 10.59 | 10.88 | 11.34 |
| 29 | 10.50 | 10.97 | 11.25 | 11.72 |
| 30 | 10.88 | 11.34 | 11.63 | 12.09 |
| 31 | 11.25 | 11.72 | 12.00 | 12.47 |
| 32 | 11.63 | 12.09 | 12.38 | 12.84 |
| 33 | 12.00 | 12.47 | 12.75 | 13.22 |
| 34 | 12.38 | 12.84 | 13.13 | 13.59 |
| 35 | 12.75 | 13.22 | 13.50 | 13.97 |
| 36 | 13.13 | 13.59 | 13.88 | 14.34 |

Barrier Strips

2

Note: All part numbers are RoHS Compliant.

0.375" [9.56] Pitch, Series RSB6 (Continued)

Ordering Information

RSB 6 R P 07 12 02 11
A **B** **C** **D** **E** **F** **G** **H**

A Single Screw Tri-Barrier Strips RSB

B Contact Spacing
6=.375 in. (6/16)

C Mounting Position Options
V= Vertical Mounting
H= High Rise (use with #18 terminal style)

D End Contact Options
E= Open end pos. with mounting inserts
M= Open end positions
P= All positions filled with contacts

E No. of Circuits (Not Positions)
02 through 34 for M Option
02 through 36 for P Option

F Terminal Style
11=Superseded by 6STV, page 129
12=Circuit Board, V Mounting (select this option when block is to be used with RSB plug-in socket)
13=Superseded by 6TBV, page 129
14=Superseded by 6STR, page 129
15=Superseded by 6PCR, page 129
16=Superseded by 6WWR, page 129
17=Superseded by 6WWV, page 129
18=Circuit Board (for High Rise Mounting)

G Top Hardware Options
01= Bright zinc and chromate plated steel binding-head screw
02= Bright zinc and chromate steel screw and captive clamp – Do not order in combination with other top hardware
03=Stainless steel binding-head screw
04=Nickel plated brass binding-head screw
09=Nickel plated brass screw and captive clamp – Do not order in combination with other top hardware

Quick-Connect Blades

(supplied with 01 screw)

| | | .250 [6.35] wide | .187 [4.75] wide |
|----|-----|------------------|------------------|
| | | x.032 [.81] | x.020 [.51] |
| | | thick | thick |
| 22 | 42= | | |
| 23 | 43= | | |
| 24 | 44= | | |
| 25 | 45= | | |
| 29 | 49= | | |
| 30 | 50= | | |
| 31 | 51= | | |
| 33 | 53= | | |
| 35 | 55= | | |
| 36 | 56= | | |

H Circuit Identification Options
Request drawing C7013624 for complete information

| Front | Top |
|-------|----------------------------|
| 11 | 21 = 12345... |
| 12 | 22 = ...54321 |
| 13 | 23 = 1 2 3 4 5 . . . |
| 14 | 24 = . . . 5 4 3 2 1 |
| 15 | 25 = 12345... 12345... |
| 16 | 26 = ...54321 . . .54321 |
| 17 | 27 = 1 2 3 4 5 . . . |
| 18 | 28 = . . . 5 4 3 2 1 . . . |

For mating socket, see pg. 152.



Note: All part numbers are RoHS Compliant.

0.375" [9.56] Pitch, Series RSB6, Features/Options

Terminal Style

Vertical Terminal

Catalog Number Code 12: Designed specifically for use with our RSB6B Socket, page 163.



Mounting & Contact Position Options

Vertical, Direct Mounting

Catalog Code VP: This configuration is frequently used on printed circuit boards where solder connections are used to fasten the block to the board.



Vertical, End Position Mounting

Catalog Code VM:

Used where end sections are needed for mounting. Thickness of base is sufficient to support mounting screws.



High Rise, All Positions Filled with Contacts

Catalog Code HP:

Designed for high density; two rows deep when used in conjunction with a VP configuration.



Top Hardware Options:

Binding Head Screws

Four Styles Available.



Captive Clamp

Catalog Number Code: 02 & 09.

For applications requiring extra security, captive clamps under the screw heads augment the locking tabs on each contact. Screws have #8 pan head with a unique Phil-slot design accepting either Phillips-head or straight screwdriver. The body is #6 to allow use of larger wire.



Quick Connects

Catalog Code below: A selection of .187" and .250" quick connect blades with tin plated brass are available for connecting wire terminated with female quick-connects. They are available individually or in combination. See ordering information.



High Rise, Mounting Standoffs

Designed for high density; allows two rows of contacts on two levels when used with a VP mounting configuration.



Barrier Strips
2



Note: All part numbers are RoHS Compliant.

Accessories — Barrier Strip Safety Covers

For Series BC6, #3, JC6



For Series BC6, #3, JC6 Mounting

TC 3—Aluminum mounting bushings and screws

TC 2, 9—Plastic fasteners attached to block with thru-bolts and nuts (not supplied)

Center Spacing

TC 3—0.250 inch [6.35]

TC 2, 9—0.375 inch [9.56]

Material—Clear, rigid PVC, UL94V-0

For Series #4, #6, #8 Physical Properties

Centerline spacing—8.2/[.325] - 9.5/[.375] 11.1/[.4375]

Positions—2 thru 16, molded to length

Material—Black, thermoplastic, UL94V-0

Shock and Vibration—to MIL-STD. 1344 method 2005.1 Condition III.

For Series #4, #6, #8



Ordering Information

TC 4 - 06 - PFH - CL

A B C D E

A Series

TC = Cover

B Center Spacing

- 2 = BC6 Series
- 3 = #3 Series
- 4 = #4 Series
- 6 = #6 Series
- 8 = #8 Series
- 9 = JC6 Series

C No. of Circuits

- (Not positions)
- 02 through 24 for Series BC6, JC6
- 02 through 30 for Series #3
- 02 through 16 for Series #4, #6, #8

D Access Holes

- PF* = Press Fit without holes
- PFH* = Press Fit with holes
- AG = Adder for Series BC6, #3, JC6
- E Color** (add for Series #4, #6, #8 only)
- (blank) = Black (Series BC6, #3, JC6 are clear)
- CL = Translucent (Available only for Series #4, #6, #8)

| Overall Height (O.H.) | | |
|-----------------------|--------|--------|
| TC2 | TC3 | TC9 |
| 0.970" | 0.650" | 0.970" |

* Add for Series #4, #6, #8

| Catalog # | A | B | C | D Ref. | L |
|-----------|--------------|------------|-------------|--------------|-------------------------|
| TC4 | 8,2 (.325) | 6,0 (.238) | 13,5 (.531) | 5,7 (.225) | A* (N-1)+7,9/(.312) #4 |
| TC6 | 9,5 (.375) | 6,3 (.250) | 13,3 (.525) | 6,4 (.253) | A* (N-1)+4/(.370) #6 |
| TC8 | 11,1 (.4375) | 8,1 (.314) | 21,5 (.846) | 11,1 (.4375) | A* (N-1)+10,9/(.430) #8 |

Note: All part numbers are RoHS Compliant.

Accessories — Barrier Strip Safety Covers (Continued)

Safety Covers

Dead front protection designed to prevent accidental contact with energized circuits. Access holes for test probes are provided over each terminal. Nylon clips are included with each cover. Covers meet UL94V-0, with 50°C temperature index. Blank circuit identification optional.

For SSB3, RSB3, RSB6 and SSB7 Series.

Related Product Data

Wire Pins and Ferrules

Pages 109-111
For more information on Tyco Electronics Standard Terminals and Splices or Quick-Connect FASTON Receptacles and Tabs, request Catalog 82042.



Ordering Information



Accessories — Quick-Connect (QC) Tabs

Physical Properties

Tabs

Material—Tin plated brass

Dimensions— #4 Series 0.187" wide x 0.020" thick, #6 Series 0.250" wide x 0.032" thick (0.187" x 0.020" optional), #8 Series 0.250" wide x 0.032" thick

Ordering Information: Tabs

QC4 - 180 - 3

A

B

C

A Style Size

QC4 = for #4 Series (45° tab angle not available)

QC6 = for #6 Series

QC8 = for #8 Series

C Tab Size

3 = 0.187 w x 0.020

4 = 0.250 w x 0.032

B Tab Angle

180 = 180° (flat)

45 = 45°

90 = 90°

Note: QC tabs may be stacked to achieve several angle configurations.



90°



45°



180°



Stackable Tabs

.375" Pitch, Double Row

QUICK-CONNECT Tabs

| Description | .250 wide x .032 thick | | .187 wide x .032 thick | |
|--------------------|------------------------|-----------|------------------------|-----------|
| | Part No. | Cat. No. | Part No. | Cat. No. |
| Flat, Two-Sided | — | 1776860-1 | — | 1776803-1 |
| 45°, Two-Sided | ∨ | 1776860-2 | — | 1776803-2 |
| 90°, Two-Sided | ┌ | 1776860-3 | — | 1776803-3 |
| Flat, Single-Sided | — | 1776843-1 | — | — |
| 45°, Single-Sided | ∨ | 1776843-2 | — | — |
| 90°, Single-Sided | ┌ | 1776843-3 | — | — |

.0325" Pitch, Series SSB3

QUICK-CONNECT Tabs

| Description | .110 wide x .020 thick | | .187 wide x .020 thick | |
|--------------------|------------------------|---------------------|------------------------|----------|
| | Part No. | Cat. No. | Part No. | Cat. No. |
| Flat, Two-Sided | — | 5-1437402-7 QC10 | 7-1437402-5 QC70 | |
| 45°, Two-Sided | ∨ | 5-1437402-8 QC11 | 7-1437402-6 QC71 | |
| 90°, Two-Sided | ┌ | 5-1437402-9 QC12 | 7-1437402-7 QC72 | |
| Flat, Single-Sided | — | 6-1437402-0 QC13 | 7-1437402-8 QC73 | |
| 45°, Single-Sided | ∨ | 6-1437402-1 QC14 | 7-1437402-9 QC74 | |
| 90°, Single-Sided | ┌ | 6-1437402-2 QC15-BU | 8-1437402-0 QC75 | |

.563" Pitch, Double Row

QUICK-CONNECT Tabs

| Description | .250 wide x .032 thick | |
|--------------------|------------------------|-----------|
| | Part No. | Cat. No. |
| Flat, Two-Sided | — | 1776173-1 |
| 45°, Two-Sided | ∨ | 1776173-2 |
| 90°, Two-Sided | ┌ | 1776173-3 |
| 45°/90°, Two-Sided | ∨┌ | 1776173-4 |
| Flat, Single-Sided | — | 1776174-1 |
| 45°, Single-Sided | ∨ | 1776174-2 |
| 90°, Single-Sided | ┌ | 1776174-3 |

.375" & .4375" Pitch, Series JC6 and SSB7

QUICK-CONNECT Tabs

| Description | .250 wide x .032 thick | | .187 wide x .020 thick | |
|-----------------------------|------------------------|-------------------|------------------------|----------|
| | Part No. | Cat. No. | Part No. | Cat. No. |
| Flat, Two-Sided | — | 1546986-1 QC20-BU | 6-1437402-9 QC40-BU | |
| 45°, Two-Sided | ∨ | 1546986-3 QC21 | 7-1437402-0 QC41 | |
| 90°, Two-Sided | ┌ | 1546986-4 QC22 | 7-1437402-1 QC42 | |
| Flat, Single-Sided | — | 6-1437402-5 QC23 | 7-1437402-2 QC43 | |
| 45°, Single-Sided | ∨ | 6-1437402-6 QC24 | 7-1437402-3 QC44 | |
| 90°, Single-Sided | ┌ | 6-1437402-7 QC25 | 7-1437402-4 QC45 | |
| Flat, Two-Sided, Extra-Long | — | 1776090-1 | — | — |
| 90°, Two-Sided, Extra-Long | ┌ | 1776090-2 | — | — |
| 45°, Two-Sided, Extra-Long | ∨ | 1776090-3 | — | — |

.437" Pitch, Double Row

QUICK-CONNECT Tabs

| Description | .250 wide x .032 thick | |
|--------------------|------------------------|-----------|
| | Part No. | Cat. No. |
| Flat, Two-Sided | — | 1776057-3 |
| 45°, Two-Sided | ∨ | 1776057-2 |
| 90°, Two-Sided | ┌ | 1776057-1 |
| Flat, Single-Sided | — | 1776110-3 |
| 45°, Single-Sided | ∨ | 1776110-2 |
| 90°, Single-Sided | ┌ | 1776110-1 |

Related Product Data

Wire Pins and Ferrules

Pages 109-111

For more information on Tyco Electronics Standard Terminals and Splices or Quick-Connect FASTON Receptacles and Tabs, request Catalog 82042.

Solder Tabs:

For making top-side solder connections
Single-Sided

| Part No. | Cat. No. |
|-------------|----------|
| 1-1437403-1 | ST80 |

Order Number

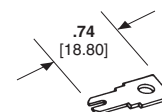

ST80

Note: All part numbers are RoHS Compliant.

Accessories — Jumpers

AROUND-THE-BARRIER
40 circuits; snap apart to desired lengths.
Spade Jumper

Catalog Number Part No.
J3140 (for 0.325" Pitch) 5-1437418-3



Spade Jumper

J6140 (for 0.375" Pitch and #6 Screw) 5-1437418-4



Flanged Spade Jumper

J6240 (for 0.375" Pitch and #6 Screw) 5-1437418-5



Ring Tongue Jumper

J6340 (for 0.375" Pitch and #6 Screw) 5-1437418-6

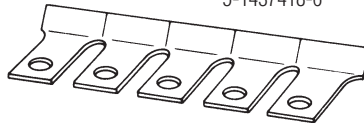

Spade Jumper

Catalog Number Part No.
J7140 (for 0.4375" Pitch and #6 Screw) 5-1437418-7



Flanged Spade Jumper

J7240 (for 0.4375" Pitch and #6 Screw) 5-1437418-8



Ring Tongue Jumper

J7340 (for 0.4375" Pitch and #6 Screw) 5-1437418-9



Over-the-Barrier Two Circuit (Brass, Tin Plated)

Spade Jumper

J74 (for 0.375" Pitch, Series RSB6 & SSB6; 0.4375" Pitch, SSB7) 6-1437418-0



J76 (0.4375" and 0.375" Double-Row) 1776058-1

Ring Tongue Jumper

J75 (for 0.375" Pitch, Series RSB6 & SSB6; 0.4375" Pitch, SSB7) 6-1437418-1



J77 (0.563" Double-Row) 1776058-1

Order Number

JX X

A B

A Block Series

- J3 = #3 Series
- J4 = #4 Series, 4DB
- J6 = #6 Series, JC6, BC6, NC6, MB6
- J8 = #8 Series, 1546670, 1546671

B No. of Circuits (Not positions)
2 through 16



Jumpers J4, J6 and J8

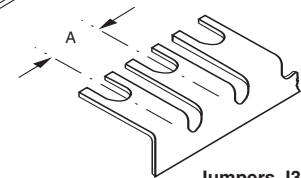

Jumpers J3

| Block Series | Centerline Spacing A |
|--------------|----------------------|
| J3 | 6,4 (0.250") |
| J4 | 8,3 (0.325") |
| J6 | 9,5 (0.375") |
| J8 | 11,1 (0.438") |

Note: All part numbers are RoHS Compliant.

Accessories — Hardware & Brackets

| | | Catalog Number | Part Number | Description | Series |
|----------------------------|---|-----------------------|--------------------|------------------------------|---------------------------------|
| Binding Head Screws |  | 3L01 | 1437402-2 | #6-32 Steel w/clear chromate | RSB3, SSB3 |
| | | L01 | 2-1437402-4 | #6-32 Steel w/clear chromate | SSB6, SSB7, RSB6 |
| | | — | 8-1437649-4 | #4-40 Steel w/clear chromate | Series #4 |
| | | | 1437651-8 | #6-32 Steel w/clear chromate | Series #6, BC6, NC6, JC6 |
| | | L03 | 2-1437402-6 | #6-32 Stainless Steel | SSB6, SSB7, RSB6 Series #6, JC6 |
| | | L04 | 2-1437402-7 | #6-32 Brass w/nickel plate | SSB6, SSB7, RSB6 |
| | | — | 1447429-1 | #8-32 Steel w/clear chromate | Series #8 |
| Wire Clamp Screws |  | 3L02 | 1437402-3 | #6-32 Steel w/clear chromate | RSB3, SSB3 |
| | | L02 | 2-1437402-5 | #6-32 Steel w/clear chromate | SSB6, SSB7, RSB6 |
| | | L09 | 2-1437402-8 | #6-32 Brass w/nickel plate | SSB6, SSB7, RSB6 |
| | | — | 8-1437649-0 | #4-40 Steel w/clear chromate | Series #4 |
| | | — | 1437651-5 | #6-32 Brass w/nickel plate | Series #6, BC6, JC6, NC6, MB6 |
| | | — | 1437651-2 | #6-32 Steel w/clear chromate | Series #6, BC6, JC6, NC6, MB6 |
| | | — | 1447425-1 | #8-32 Steel w/clear chromate | Series #8 |
| | | — | 9-1437667-9 | #6-32 Steel w/clear chromate | 4DB |

| | | Catalog Number | Part No. |
|--|---|------------------------|-----------------|
| MOUNTING INSERTS (Nylon) for mounting RSBs with blank end sections |  | L91 | 5-1437402-1 |
| PRESS-ON RETAINING CLIPS (Stainless Steel) for mounting turret base SSBs, JC6, and BC6 |  | JC/BC-Retaining | 1437661-7 |
| Angle Bracket for mounting SSBs with right angle terminals, copper alloy, tin plated |  | L92 | 5-1437402-2 |

Note: All part numbers are RoHS Compliant.

Accessories — Standard and Custom Legends

Product Facts

- n Permanent markings, impervious to cleaning solvents per MIL-STD 202, Method 215
- n Alphabetical and numerical legending
- n Numbers and characters can be in any order
- n Size and spacing of characters may be tailored to your application
- n White markings standard
- n Custom legends available on special request

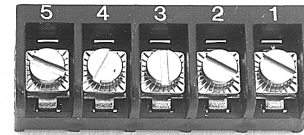

Custom legending can lend a personal touch to your product...helps in circuit identification and makes wiring faster and easier. Alphabetical and numerical markings are available in either standard or custom styles to best suit your specific applications. Legending is available to the styles depicted below.

Standard Legending Arrangements

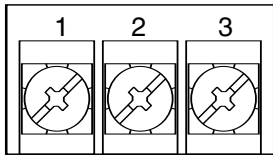

Style A1

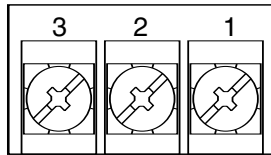

Style B1

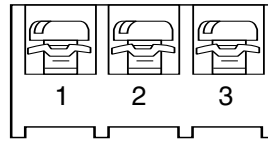

Style C1

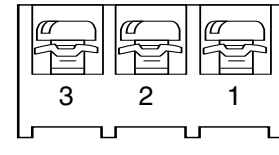

Style D1

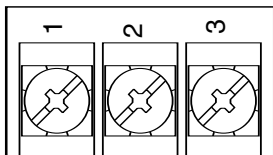

Style A2

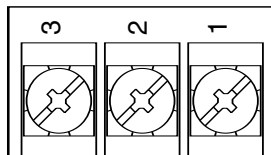

Style B2

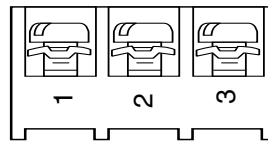

Style C2

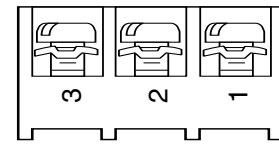

Style D2

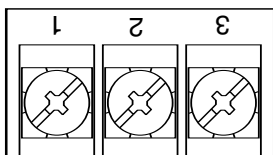

Style A3

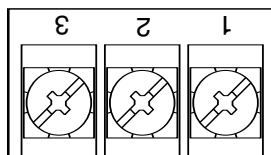

Style B3

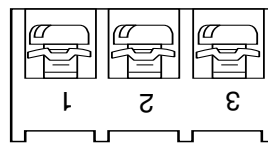

Style C3

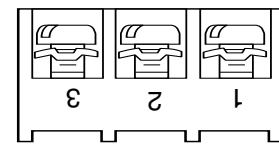

Style D3

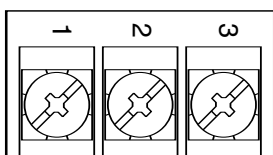

Style A4

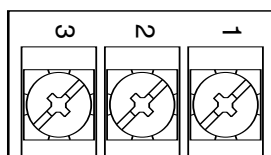

Style B4

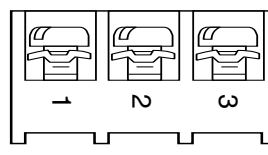

Style C4

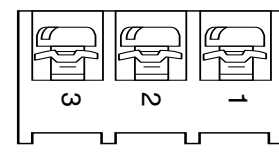

Style D4

Note: All part numbers
are RoHS Compliant.

Engineering Notes

