

RTA Series

1-4 Poles Coded Rotary Switches



Features/Benefits

- PCB or hand soldering versions
- Bushing mounting
- Multiple poles
- Decimal and hexadecimal codes
- Screwdriver slot or extended actuator
- RoHS Compliant

Typical Applications

- Appliances
- Electronic alarm systems
- Medical
- Building automation
- HVAC air conditioning

Electrical Data

| | Silver | Gold |
|---|-------------------|-------------------|
| SWITCHING MODE: | BBM | BBM |
| MAX. SWITCHING POWER | 5 VA | 0.5 VA |
| MAX. SWITCHING CURRENT: | 150 mA | 20 mA |
| MAX. CARRYING CURRENT: | 5 A | 1 A |
| NOMINAL VOLTAGE AT 50 Hz | 60 V | 25 V |
| CONTACT RESISTANCE: | < 150 mΩ | < 150 mΩ |
| DIELECTRIC STRENGTH AT 50 Hz BETWEEN CONTACTS AND GROUND TERMINALS: | 500 V r | 500 V r |
| INSULATION RESISTANCE BETWEEN CONTACTS OR CONTACTS AND FRAME (500 V ⇒): | 10 ⁹ Ω | 10 ⁹ Ω |
| NO. OF OPERATIONS: | 10,000 | 10,000 |
| BOUNCE: | < 5 ms | < 5 ms |

Mechanical Data

MAX. NO. OF BANKS: 1.
 OPERATING TORQUE: 5 Ncm±20%.
 END STOP TORQUE: 50 Ncm. minimum
 STOP: With/without or adjustable
 MOUNTING: By fixed index 9.5 mm (0.374) of center, for bushing mount only

Materials

BUSHING/HOUSING: PETP Thermoplastic
 STATIONARY CONTACTS & TERMINALS: Nickel Plated Brass with additional plating of Gold or Silver.
 ROTOR: Gold or Silver plated Brass or PCB.
 CODING PLATE: PA thermoplastic
 ACTUATOR: Polysulfon thermoplastic
 HARDWARE: Stop pin: Aluminum. Ball & Spring: Stainless steel. Washer: PA. Nut: Brass.

Environmental Data

OPERATING TEMPERATURE: -20°C to + 70°C -20°C to + 70°C
 STORAGE TEMPERATURE: -40°C to + 85°C -40°C to + 85°C

NOTE: Specifications and materials listed above are for switches with standard options. For information on specific and custom switches, consult Customer Service Center.

Build-A-Switch

To order, simply select desired option from each category and place in the appropriate box. Available options are shown and described on pages K-9 thru K-12. For additional options not shown in catalog, consult Customer Service Center.



Designation

RTA

Indexing

- 2** 22.5 index (coded only)
- 3** 30° index (12 positions max.)
- 4** 36° index (10 positions max.)

Termination

- P** With PC Thru-hole
- H** Horizontal with PC Thru-hole

Switch Function

- 1W12** SP, 30° Index, 12 pos. no stop
- 1W10** SP, 36° Index, 10 pos. no stop
- 1S02** SP, 30° /36° Index, 2 pos.
- 1S03** SP, 30° /36° Index, 3 pos.
- 1S04** SP, 30° /36° Index, 4 pos.
- 1S05** SP, 30° /36° Index, 5 pos.
- 1S06** SP, 30° /36° Index, 6 pos.
- 1S07** SP, 30° /36° Index, 7 pos.
- 1S08** SP, 30° /36° Index, 8 pos.
- 1S09** SP, 30° /36° Index, 9 pos.
- 1S10** SP, 30° /36° Index, 10 pos.
- 1S11** SP, 30° Index, 11 pos.
- 1S12** SP, 30° Index, 12 pos.
- 2S02** DP, 30° /36° Index, 2 pos.
- 2S03** DP, 30° /36° Index, 3 pos.
- 2S04** DP, 30° /36° Index, 4 pos.
- 2S05** DP, 30° /36° Index, 5 pos.
- 2S06** DP, 30° Index, 6 pos.

4S02 4P, 30° /36° Index, 2 pos.

EW10 Direct + complement, 36° Index, no stop

EW12 Direct + complement, 30° Index, no stop

ES__ Direct + complement, 30°/36° Index, with stop (specify stop position)

Mounting Style

- W** Without bushing
- R** 3/8-32 Threaded Bushing
- M** M10x.75 Metric Threaded Bushing
- A** 3/8-32 Threaded Bushing with Offset Bracket
- B** M10x.75 Metric Threaded Bushing with Offset Bracket

Contact Material

- S** Silver plated, matte-tin terminal
- P** Gold plated, matte-tin terminal

Actuator (max.)

- 25N** .984 (25,0) with screwdriver slot
- 50N** 1.97 (50,0) with screwdriver slot
- FLS** Flush shaft with screwdriver slot and position indicator
- 25F** .984 (25,0) Shaft with flat
- 06F** .236 (6,0) Shaft with flat

RTA Series 1-4 Poles Coded Rotary Switches

DESIGNATION

RTA

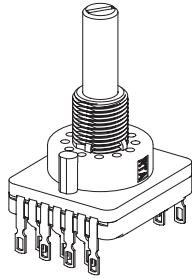

TERMINATION

P WITH PC PINS

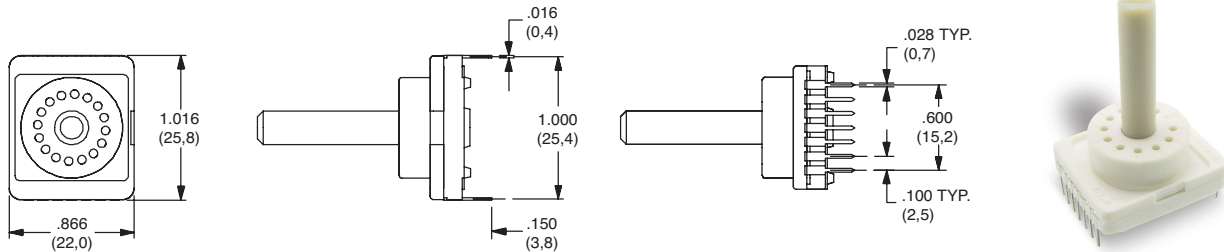

H Horizontal with PC Thru-hole

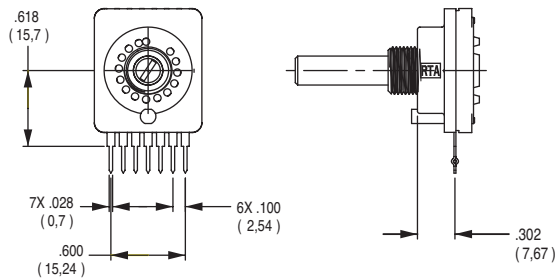

Note: "H" termination only available with the following options:
 1. With A or B mounting styles
 2. 36° degree indexing
 3. Up to 5 positions max

INDEXING

- 2** 22.5 index, 16 positions max.
- 3** 30 index, 12 positions max.
- 4** 36 index, 10 positions max.

Both commons must be connected by user to ground.



K

Rotary

RTA Series 1-4 Poles Coded Rotary Switches

SWITCH FUNCTION

| NO. POLES | MODEL NO. | SWITCH FUNCTION | INDEX |
|-----------|-------------|-------------------------|---------|
| SP | 1W12 | 12 Positions No Stop | 30° |
| | 1W10 | 10 Positions No Stop | 36° |
| | 1S02 | 2 Positions | 30°/36° |
| | 1S03 | 3 Positions | 30°/36° |
| | 1S05 | 5 Positions | 30°/36° |
| | 1S06 | 6 Positions | 30°/36° |
| | 1S08 | 8 Positions | 30°/36° |
| | 1S09 | 9 Positions | 30°/36° |
| | 1S10 | 10 Positions | 30°/36° |
| | 1S11 | 11 Positions | 30° |
| | 1S12 | 12 Positions | 30° |

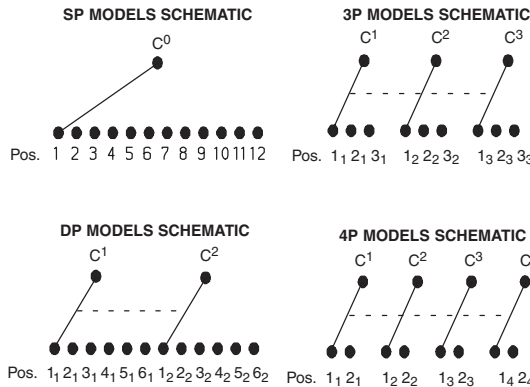

| MODEL NO. | SWITCH FUNCTION | INDEX |
|-------------|--|-----------|
| EW10 | Direct + complement, No stop | 36° |
| EW12 | Direct + complement, No stop | 30° |
| ES__ | Direct + complement, with stop (specify stop position) | 30° & 36° |

| NO. POLES | MODEL NO. | SWITCH FUNCTION | INDEX |
|-----------|-------------|------------------------|---------|
| DP | 2W05 | 5 Positions No Stop | 30°/36° |
| | 2W06 | 6 Positions No Stop | 30° |
| | 2S02 | 2 Positions | 30°/36° |
| | 2S03 | 3 Positions | 30°/36° |
| | 2S04 | 4 Positions | 30°/36° |
| | 2S05 | 5 Positions | 30°/36° |
| 4P | 2S06 | 6 Positions | 30° |
| | 4S02 | 2 Positions | 30°/36° |

| 22.5° | 30° | 36° | Pos. | 1 | 2 | 3 | 4 | 5 | 6 | 7 | 8 | 9 | 10 | 11 | 12 | 13 | 14 | 15 | 16 |
|-------|-------|-------|------|---|---|---|---|---|---|---|---|---|----|----|----|----|----|----|----|
| Term. | Term. | Term. | | | | | | | | | | | | | | | | | |
| E,J | M,N | L,N | C | • | • | • | • | • | • | • | • | • | • | • | • | • | • | • | • |
| F,I | H | D | 1 | | • | | • | | • | | • | | • | | • | | • | | • |
| D,K | D | B | 2 | | | • | • | | | • | • | | | • | • | | | • | • |
| A,N | A | I | 4 | | | | | • | • | | | • | | | | • | • | | |
| B | J | J | 8 | | | | | | | | | • | • | • | • | | | • | • |
| — | C | K | 1 | • | | • | | • | | • | | • | | • | | • | | • | |
| — | K | H | 2 | • | • | | | • | • | | | • | • | | | • | • | | |
| — | B | A | 4 | • | • | • | • | | | | | • | • | • | • | | | | |
| — | I | C | 8 | • | • | • | • | • | • | • | • | | | | | | | | |

Indexing Option Code 2, 22.5 INDEXING ANGLE PCB LAYOUT

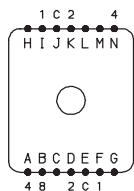

BCD ONLY

Indexing Option Code 3, 30 INDEXING ANGLE PCB LAYOUT

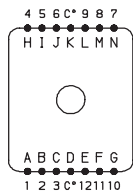

1 POLE

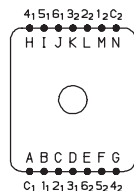

2 POLES

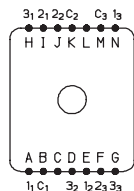

3 POLES

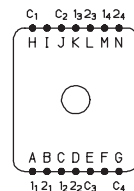

4 POLES

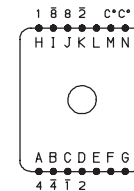

BCD + COMPLEMENTS

Indexing Option Code 4, 36 INDEXING ANGLE PCB LAYOUT



1 POLE



2 POLES

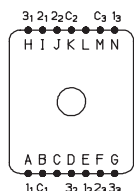

3 POLES

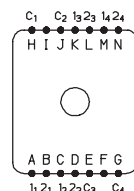

4 POLES

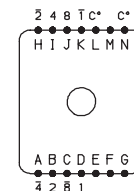

BCD + COMPLEMENTS

NOTE: Layout view from component side.

Common terminals that are in locations A-G are not connected to common terminals that are in locations H-N. For 7-12 position output customer must tie these commons together.



Third Angle Projection

Dimensions are shown: Inch (mm)

Specifications and dimensions subject to change



3 dec 18

RTA Series 1-4 Poles Coded Rotary Switches

MOUNTING STYLE

W WITHOUT BUSHING

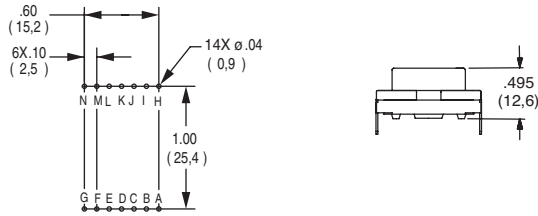

Note: W mounting style not available with H termination.

M M10 x .75 MERTIC THREADED BUSHING

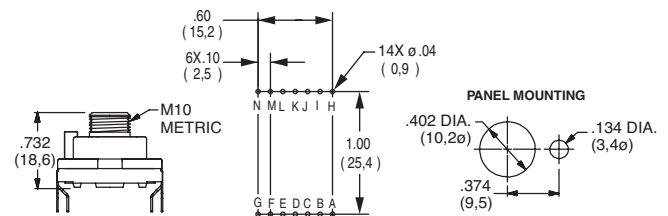

Note: M mounting style not available with H termination.

R 3/8-32 THREADED BUSHING

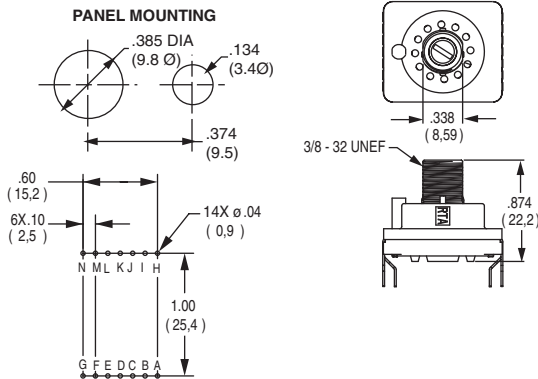

Note: R mounting style not available with H termination.

A 3/8-32 THREADED BUSHING WITH BRACKET

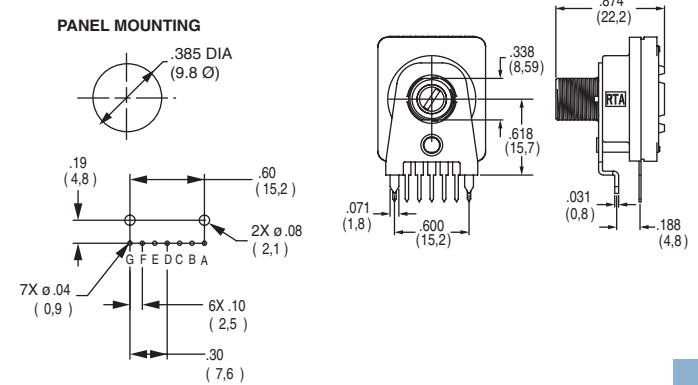

Note: A mounting style only available with H termination.

B M10 x .75 METRIC THREADED BUSHING WITH BRACKET

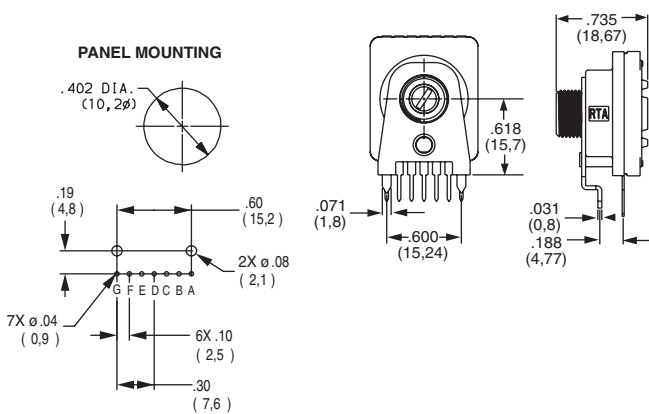

Note: B mounting style only available with H termination.

C 3/8-32 THREADED BUSHING WITH STRAIGHT BRACKET

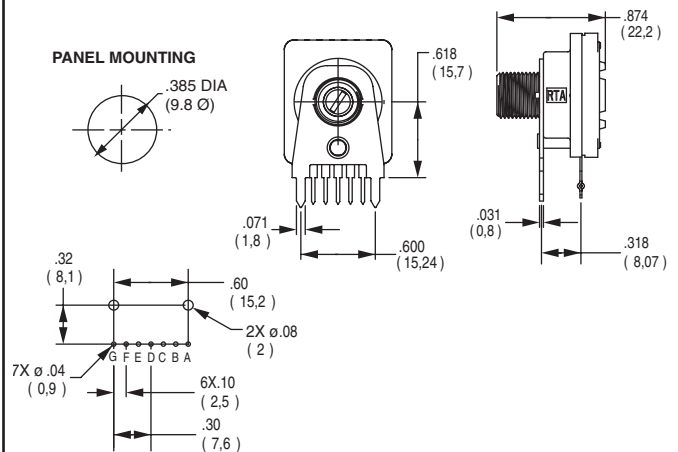

D M10 x .75 METRIC THREADED BUSHING WITH STRAIGHT BRACKET

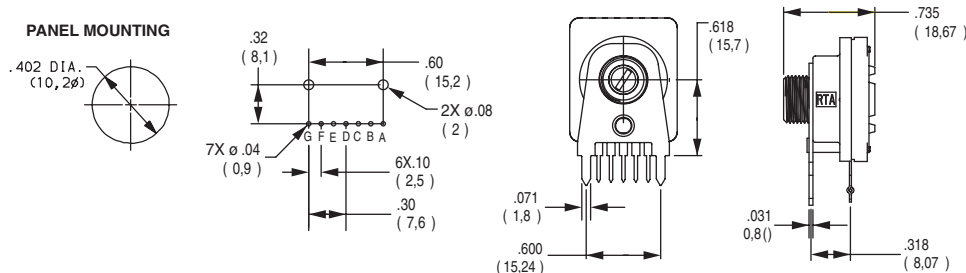

Third Angle
Projection

Dimensions are shown: Inch (mm)
Specifications and dimensions subject to change



K

Rotary

RTA Series 1-4 Poles Coded Rotary Switches

ACTUATOR

25N .984 (25,0) WITH SCREWDRIVER SLOT

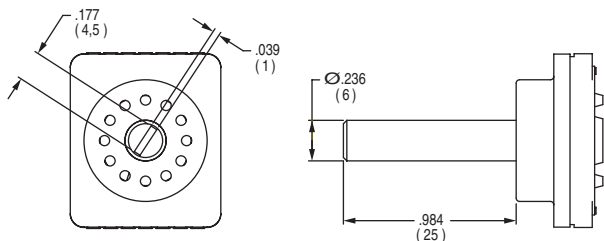

50N 1.97 (50,0) WITH SCREWDRIVER SLOT

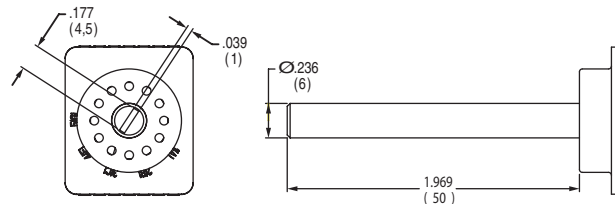

FLS FLUSH SHAFT WITH SCREWDRIVER SLOT AND POSITION INDICATOR

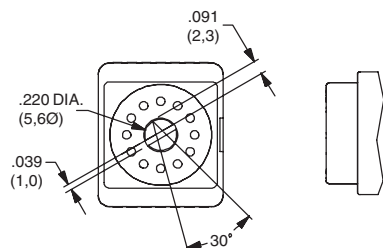

Note: only available with "W" Mounting Style

25F .984 (25,0) SHAFT WITH FLAT

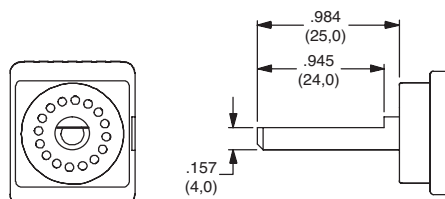

Note: only available with "W" Mounting Style

06F .236 (6,0) SHAFT WITH FLAT

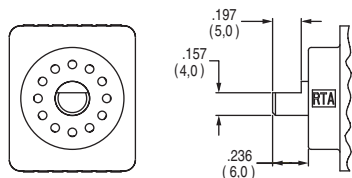

Note: only available with "W" Mounting Style

CONTACT MATERIAL

| OPTION CODE | CONTACT AND TERMINAL MATERIAL | RATING | |
|-------------|-------------------------------|--------------------------------|--|
| S | SILVER | LOW LEVEL/DRY CIRCUIT | SWITCH: 150 mA MAXIMUM, 60 V NOMINAL. POWER: 5 VA MAXIMUM. CARRY-5 AMPS MAXIMUM. |
| P | GOLD | LOW LEVEL/DRY CIRCUIT OR POWER | SWITCH: 20 mA MAXIMUM, 25 V NOMINAL. POWER: 0.5 VA MAXIMUM. CARRY: 1 AMP MAXIMUM. |

* Note: See Technical Data section of this catalog for RoHS compliant and compatible definition and specifications.

AVAILABLE HARDWARE

Mounting Nuts

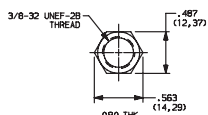

PART NO.
472706201
Standard

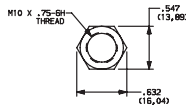

PART NO.
495100201
Metric

Stop pins



PART NO.
Y200300200PCH

Lockwasher

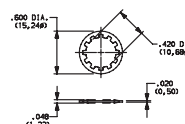

PART NO.
472800202

NOTE: Additional nuts and lockwashers available separately, see section "Technical Data and Additional Hardware".



Third Angle
Projection

Dimensions are shown: Inch (mm)
Specifications and dimensions subject to change