

Main

Range of product	Modicon M258
Product or component type	Logic controller
Product specific application	-
Discrete I/O number	42
Discrete output number	12 relay output 4 fast output

Complementary

Discrete input number	10 fast input 12 input 4 regular input
Discrete input logic	Sink fast input Sink regular input Source input
Discrete input voltage	24 V
Discrete input voltage type	DC
Voltage state 1 guaranteed	>= 15 Vfor fast input >= 15 Vfor fast output >= 15 Vfor regular input
Voltage state 0 guaranteed	<= 5 Vfor fast input <= 5 Vfor fast output <= 5 Vfor regular input
Discrete input current	4 mAfor fast input 4 mAfor regular input
Input impedance	6 kOhm fast input 6 kOhm regular input
Configurable filtering time	0 ms fast input/regular input and fast output 1.5 ms fast input/regular input and fast output 12 ms fast input/regular input and fast output 4 ms fast input/regular input and fast output
Anti bounce filtering	2 μs...4 ms (configurable) fast input/regular input and fast output
Cable distance between devices	30 m for fast input 30 m for fast output 30 m for regular input
Isolation between channels and internal logic	500 Vrms AC
Isolation between channels	None
Discrete output logic	Source
Discrete output voltage	24 V DC
Output voltage limits	19.2...28.8 V
Discrete output current	4 mAfor fast output
[Us] rated supply voltage	24 V DC embedded expert modules power 24 V DC I/O power segment 24 V DC main supply
Supply voltage limits	20.4...28.8 V
[In] rated current	0.04 Afor embedded expert modules power 0.33 Afor main supply 10 Afor I/O power segment
Peak current	<= 100 kA during <= 70 s main supply <= 25 kA during <= 500 s I/O power segment <= 50 kA during <= 150 s embedded expert modules power 1.2 A during > 70 s main supply

The information provided in this documentation contains general descriptions and/or technical characteristics of the performance of the products contained herein. This documentation is not intended as a substitute for and is not to be used for determining suitability or reliability of these products for specific user applications. It is the duty of any such user or integrator to perform the appropriate and complete risk analysis, evaluation and testing of the products with respect to the relevant specific application or use thereof. Neither Schneider Electric Industries SAS nor any of its affiliates or subsidiaries shall be responsible or liable for misuse of the information contained herein.

Power consumption in W	<= 17.22 W
Execution time per instruction	22 ns : Boolean
Memory description	Flash 128 MB Internal RAM 64 MB
Realtime clock	With user calibration realtime clock, drift: <= 6 s/month Without any user calibration realtime clock, drift: < 30 s/monthat 77 °F (25 °C)
Data backed up	Variables of type retain and retain persistent CR2477M Renata, 1.5 years autonomy
Integrated connection type	1 CANopen male SUB-D 9, CANopen master 1 isolated serial link female RJ45, Ethernet Modbus TCP/IP slave (10BASE-T/100BASE-TX) 2 free slots PCI 1 isolated serial link female RJ45, Modbus master/slave RTU/ASCII or character mode ASCII (RS232/RS485), 300...115200 bps 1 isolated serial link mini B USB, 480 Mbit/s 1 isolated serial link USB type A, 480 Mbit/s
Transmission rate	125 kbit/s for bus length of 1640.42 ft (500 m), CANopen 250 kbit/s for bus length of 820.21 ft (250 m), CANopen 500 kbit/s for bus length of 3280.84 ft (1000 m), CANopen 500 kbit/s for bus length of 328.08 ft (100 m), CANopen 10 kbit/s for bus length of 16404.2 ft (5000 m), CANopen 1000 kbit/s for bus length of 13.12 ft (4 m), CANopen 20 kbit/s for bus length of 8202.1 ft (2500 m), CANopen 800 kbit/s for bus length of 82.02 ft (25 m), CANopen
Counting input number	8 counting input(s) 200 kHz
Local signalling	1 LED per channel I/O state 1 LED CAN0 STS 1 LED MBS COM 1 LED green/red APP0 1 LED green/red APP1 1 LED green/red Eth NS (Ethernet network status) 1 LED green/red Eth ST (Ethernet status) 1 LED green/red RUN/MS (module status) 1 LED green/red USB host 1 LED green/yellow Eth LA (Ethernet activity) 1 LED red BATT (battery status)
Marking	CE
Mounting support	Symmetrical DIN rail
Width	10.33 in (262.5 mm)
Height	3.9 in (99 mm)
Depth	3.35 in (85 mm)
Product weight	1.76 lb(US) (0.8 kg)

Environment

standards	CSA C22.2 No 142 IEC 61131-2 UL 508 CSA C22.2 No 213
product certifications	CSA C-Tick CULus GOST-R
ambient air temperature for operation	32...122 °F (0...50 °C) vertical installation 32...131 °F (0...55 °C) without derating factor horizontal installation 32...140 °F (0...60 °C) with derating factor horizontal installation
ambient air temperature for storage	-13...158 °F (-25...70 °C)
relative humidity	5...95 % without condensation
IP degree of protection	IP20 conforming to IEC 61131-2
pollution degree	2 conforming to IEC 60664
operating altitude	0...6561.68 ft (0...2000 m)
storage altitude	0...9842.52 ft (0...3000 m)
vibration resistance	1 gn 8.4...150 Hz DIN rail 3.5 mm 5...8.4 Hz DIN rail
shock resistance	15 gn 11 ms
resistance to electrostatic discharge	4 kV on contact conforming to EN/IEC 61000-4-2 8 kV in air conforming to EN/IEC 61000-4-2
resistance to electromagnetic fields	0.91 V/yd (1 V/m) 2...2.7 GHz conforming to EN/IEC 61000-4-3

	9.14 V/yd (10 V/m) 80...2000 MHz conforming to EN/IEC 61000-4-3
resistance to fast transients	1 kV I/O conforming to EN/IEC 61000-4-4 1 kV shielded cable conforming to EN/IEC 61000-4-4 2 kV power lines conforming to EN/IEC 61000-4-4
surge withstand	0.5 kV differential mode conforming to EN/IEC 61000-4-5 1 kV common mode conforming to EN/IEC 61000-4-5
disturbance radiated/conducted	CISPR 11

Offer Sustainability

Green Premium product	Green Premium product
Compliant - since 1039 - Schneider Electric declaration of conformity	Compliant - since 1039 - Schneider Electric declaration of conformity
Reference not containing SVHC above the threshold	Reference not containing SVHC above the threshold
Available	Available
Available	Available
WARNING: This product can expose you to chemicals including:	WARNING: This product can expose you to chemicals including:
Lead and lead compounds, which is known to the State of California to cause cancer and birth defects or other reproductive harm.	Lead and lead compounds, which is known to the State of California to cause cancer and birth defects or other reproductive harm.
For more information go to www.p65warnings.ca.gov	For more information go to www.p65warnings.ca.gov

Contractual warranty

Warranty period	18 months
-----------------	-----------



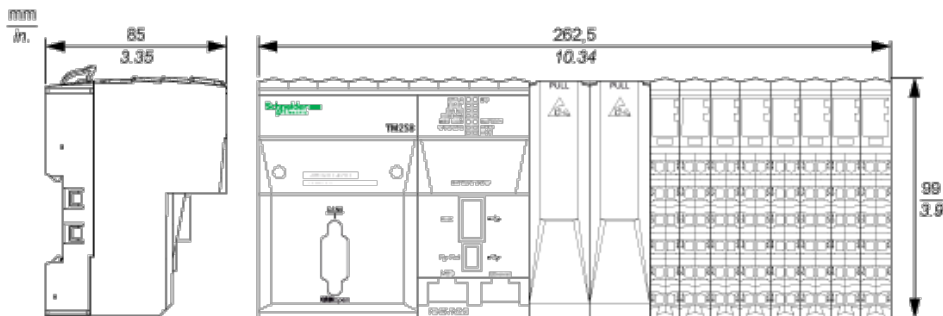

Controller

Dimensions



TM5 System Wiring Recommendations

Wire Sizes to Use with Removable Spring Terminal Blocks

mm in.					
mm ²	0,08...2,5	0,25...2,5	0,25...1,5	2 x 0,25...2 x 0,75	
AWG	28...14	24...14	24...16	2 x 24...2 x 18	

External Power Supplies

Wiring Diagram of the Controller Power Distribution Module

TM258LD42DT
TM258LF42DT●●

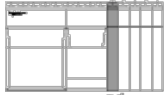

TM258LD42DT4L
TM258LF42DT4L●●



TM258LF66DT4L●●
TM258LF42DR●●

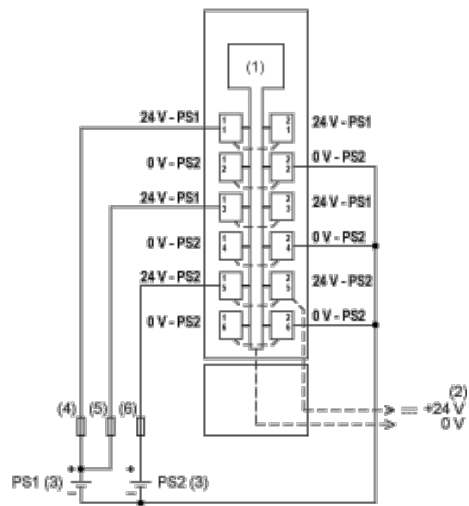
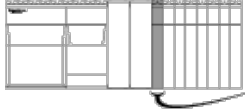

- (1) Internal electronics
- (2) 24 Vdc I/O power segment integrated into the bus bases
- (3) PS1/PS2: External isolated SELV power supply 24 Vdc
- (4) External fuse, Type T slow-blow, 3 A 250 V
- (5) External fuse, Type T slow-blow, 2 A 250 V
- (6) External fuse, Type T slow-blow, 10 A max., 250 V