

# Analog Devices Welcomes Hittite Microwave Corporation

NO CONTENT ON THE ATTACHED DOCUMENT HAS CHANGED



**THIS PAGE INTENTIONALLY LEFT BLANK**



## GaAs pHEMT MMIC POWER AMPLIFIER, 17 - 24 GHz

### Typical Applications

The HMC498 is ideal for:

- Point-to-Point Radios
- Point-to-Multi-Point Radios
- VSAT
- Military & Space

### Features

- Output IP3: +34 dBm
- Saturated Power: +27 dBm @ 25% PAE
- Gain: 24 dB
- Supply Voltage: +5V
- 50 Ohm Matched Input/Output
- Die Size: 2.38 x 1.46 x 0.1 mm

### Functional Diagram

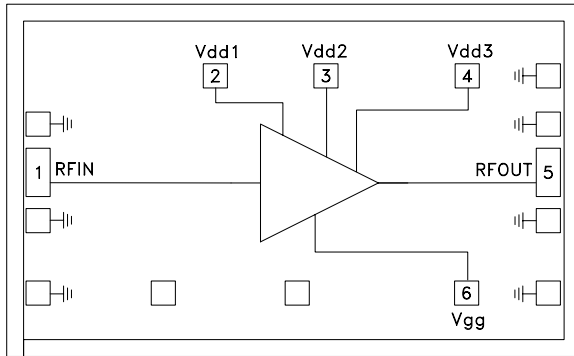

### General Description

The HMC498 is a high dynamic range GaAs pHEMT MMIC Power Amplifier which operates between 17 and 24 GHz. The HMC498 provides 24 dB of gain, +27 dBm of saturated power and 25% PAE from a +5V supply voltage. The HMC498 amplifier can easily be integrated into Multi-Chip-Modules (MCMs) due to its small size. All data is with the chip in a 50 Ohm test fixture connected via 0.025mm (1 mil) diameter wire bonds of minimal length 0.31mm (12 mils).

### Electrical Specifications, $T_A = +25^\circ \text{C}$ , $V_{dd} = 5\text{V}$ , $I_{dd} = 250\text{mA}^*$

| Parameter  | Min.    | Typ. | Max. | Min.    | Typ. | Max. | Min.    | Typ. | Max. | Units  |
|--|---------|------|------|---------|------|------|---------|------|------|--------|
| Frequency Range                                  | 17 - 19 |      |      | 19 - 22 |      |      | 22 - 24 |      |      | GHz    |
| Gain   | 20      | 23   | 28   | 21      | 24   | 28   | 20      | 23   | 28   | dB     |
| Gain Variation Over Temperature                  |         | 0.03 | 0.04 |         | 0.03 | 0.04 |         | 0.03 | 0.04 | dB/ °C |
| Input Return Loss                                |         | 11   |      |         | 11   |      |         | 8    |      | dB     |
| Output Return Loss                               |         | 20   |      |         | 18   |      |         | 15   |      | dB     |
| Output Power for 1 dB Compression (P1dB)         | 20      | 23.5 |      | 22      | 25   |      | 21      | 24   |      | dBm    |
| Saturated Output Power (Psat)                    |         | 27   |      |         | 26.5 |      |         | 25.5 |      | dBm    |
| Output Third Order Intercept (IP3)               |         | 34   |      |         | 34   |      |         | 34   |      | dBm    |
| Noise Figure                                     |         | 3.5  |      |         | 4.0  |      |         | 4.5  |      | dB     |
| Supply Current (Idd)(Vdd = 5V, Vgg = -0.8V Typ.) |         | 250  | 275  |         | 250  | 275  |         | 250  | 275  | mA     |

\* Adjust Vgg between -2 to 0V to achieve Idd = 250mA typical.



**GaAs pHEMT MMIC  
POWER AMPLIFIER, 17 - 24 GHz**

**Broadband Gain & Return Loss**

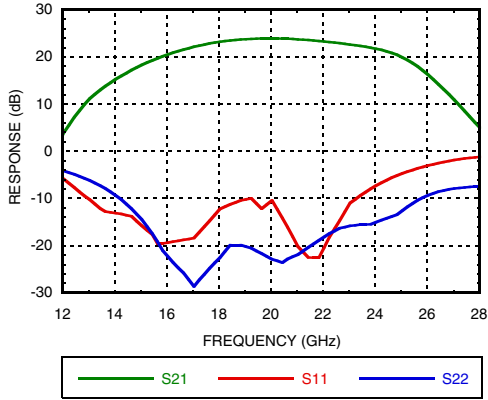

**Gain vs. Temperature**

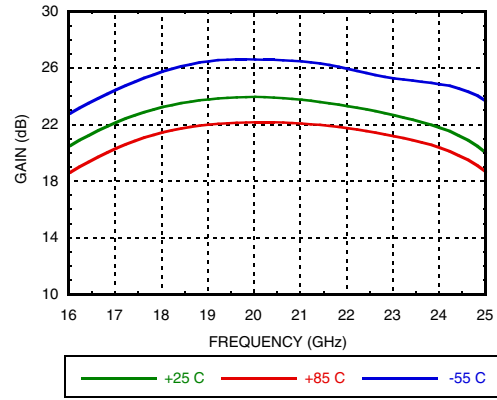

**Input Return Loss vs. Temperature**

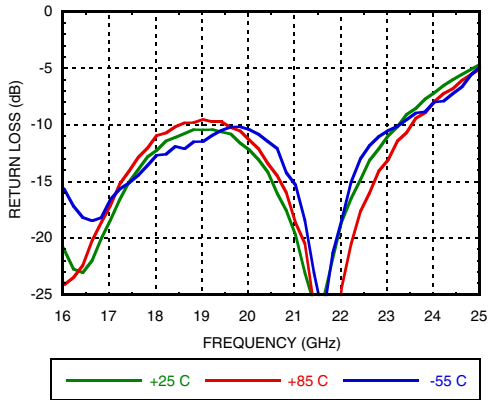

**Output Return Loss vs. Temperature**

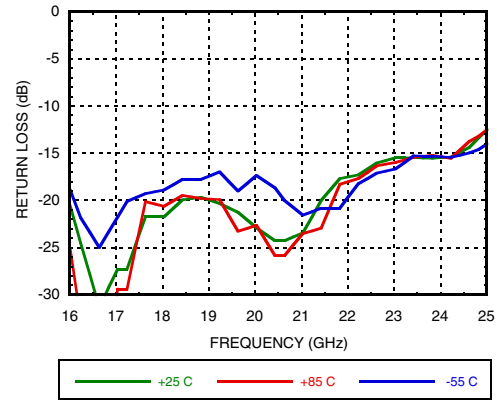

**P1dB vs. Temperature**

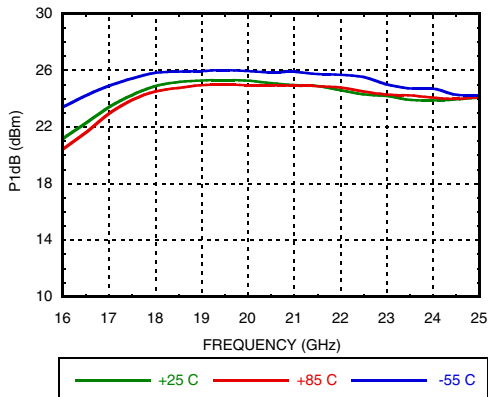

**Psat vs. Temperature**

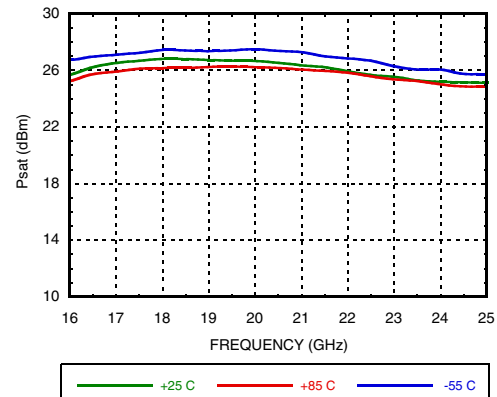



## GaAs pHEMT MMIC POWER AMPLIFIER, 17 - 24 GHz

LINEAR & POWER AMPLIFIERS - CHIP

**Output IP3 vs. Temperature**

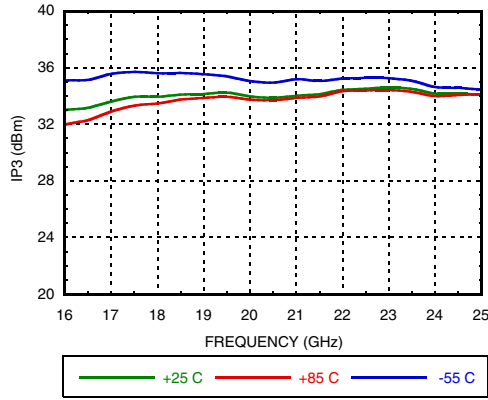

**Noise Figure vs. Temperature**

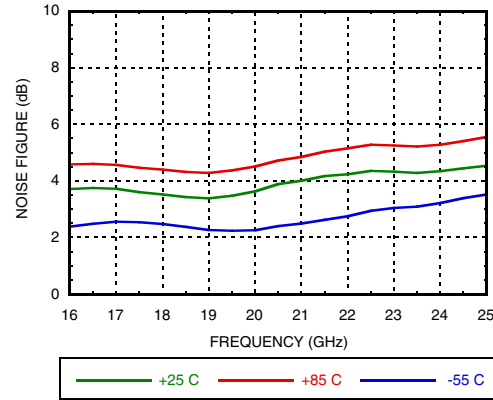

**Gain & Power vs. Supply Voltage @ 20 GHz, I<sub>dd</sub>= 250mA**

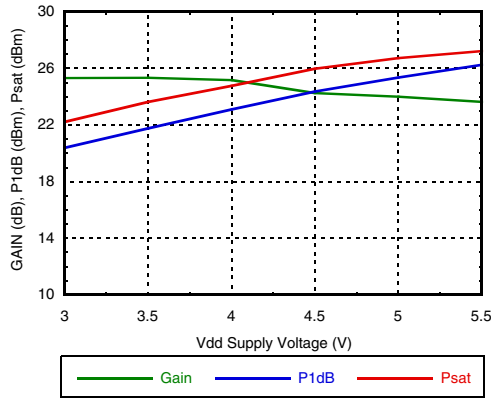

**Reverse Isolation vs. Temperature**

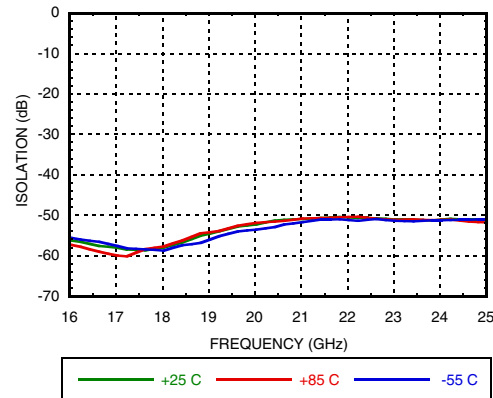

**Power Compression @ 20 GHz**

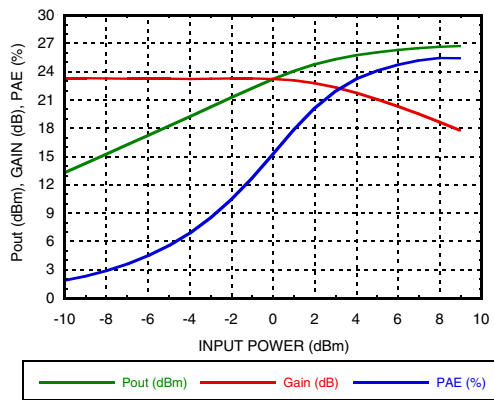

**Power Compression @ 24 GHz**

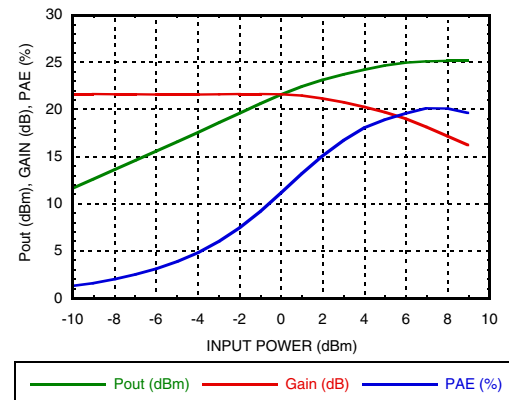

[1] Footnote if needed



## GaAs pHEMT MMIC POWER AMPLIFIER, 17 - 24 GHz

### Absolute Maximum Ratings

|   |                |
|---|----------------|
| Drain Bias Voltage (Vdd1, Vdd2, Vdd3)                         | +5.5V          |
| Gate Bias Voltage (Vgg)                                       | -4 to 0V       |
| RF Input Power (RFIN)(Vdd = +5V)                              | +10 dBm        |
| Channel Temperature   | 175 °C         |
| Continuous Pdiss (T= 85 °C)<br>(derate 21.4mW/°C above 85 °C) | 1.92 W         |
| Thermal Resistance<br>(channel to die bottom)                 | 46.8 °C/W      |
| Storage Temperature   | -65 to +150 °C |
| Operating Temperature   | -55 to +85 °C  |
| ESD Sensitivity (HBM)   | Class 1A       |

### Typical Supply Current vs. Vdd

| Vdd (V) | Idd (mA) |
|---------|----------|
| +4.5    | 241      |
| +5.0    | 250      |
| +5.5    | 258      |
| +3.0    | 240      |
| +3.5    | 250      |
| +4.0    | 259      |

Note: Amplifier will operate over full voltage ranges shown above. Vgg adjusted to achieve Idd= 250mA at +5V and +3.5V.



ELECTROSTATIC SENSITIVE DEVICE  
OBSERVE HANDLING PRECAUTIONS

### Outline Drawing

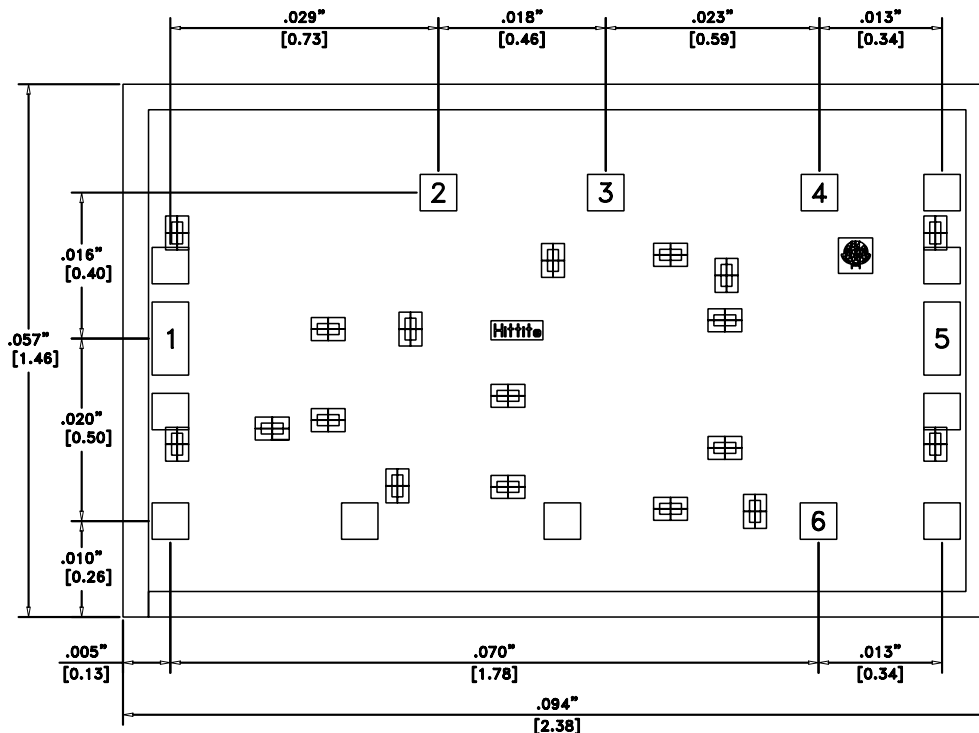

### Die Packaging Information [1]

| Standard        | Alternate |
|-----------------|-----------|
| GP-2 (Gel Pack) | [2]       |

[1] Refer to the "Packaging Information" section for die packaging dimensions.

[2] For alternate packaging information contact Hittite Microwave Corporation.

#### NOTES:

- ALL DIMENSIONS ARE IN INCHES [MM]
- DIE THICKNESS IS .004"
- TYPICAL BOND IS .004" SQUARE
- BACKSIDE METALLIZATION: GOLD
- BOND PAD METALLIZATION: GOLD
- BACKSIDE METAL IS GROUND.
- CONNECTION NOT REQUIRED FOR UNLABELED BOND PADS.



## GaAs pHEMT MMIC POWER AMPLIFIER, 17 - 24 GHz

### Pad Descriptions

| Pad Number | Function         | Description   | Interface Schematic |
|------------|------------------|---|---------------------|
| 1          | RFIN             | This pad is AC coupled and matched to 50 Ohms.  |                     |
| 2 - 4      | Vdd1, Vdd2, Vdd3 | Power Supply Voltage for the amplifier. External bypass capacitors of 100 pF and 0.01 μF are required.  |                     |
| 5          | RFOUT            | This pad is AC coupled and matched to 50 Ohms.  |                     |
| 6          | Vgg              | Gate control for amplifier. Adjust to achieve I <sub>dd</sub> of 250mA. Please follow "MMIC Amplifier Biasing Procedure" Application Note. External bypass capacitors of 100 pF and 0.01 μF are required. |                     |
| Die Bottom | GND              | Die bottom must be connected to RF/DC ground.   |                     |

### Assembly Diagram

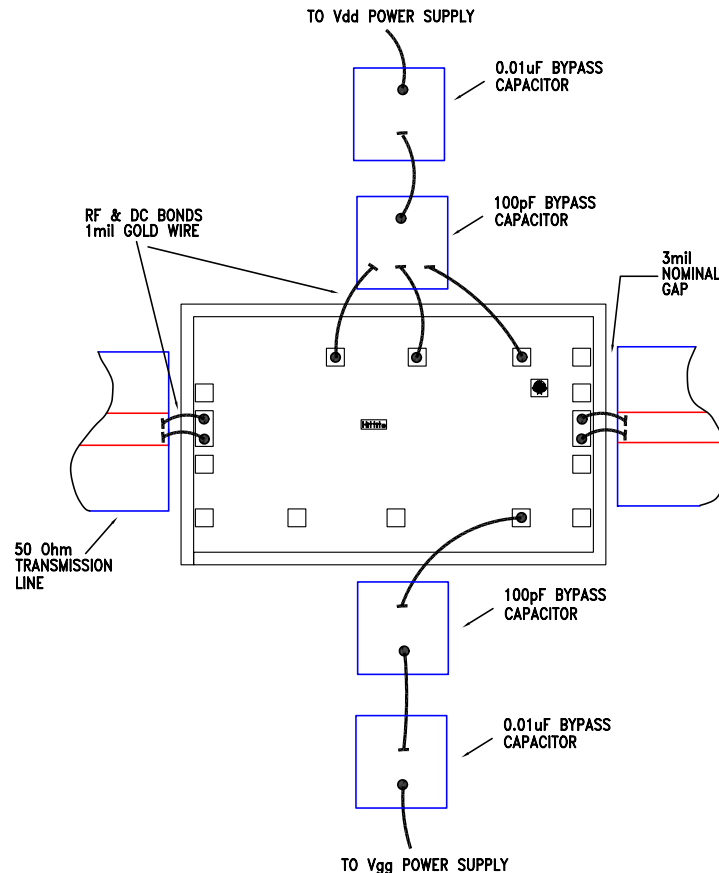

## GaAs pHEMT MMIC POWER AMPLIFIER, 17 - 24 GHz

### Mounting & Bonding Techniques for Millimeterwave GaAs MMICs

The die should be attached directly to the ground plane eutectically or with conductive epoxy (see HMC general Handling, Mounting, Bonding Note).

50 Ohm Microstrip transmission lines on 0.127mm (5 mil) thick alumina thin film substrates are recommended for bringing RF to and from the chip (Figure 1). If 0.254mm (10 mil) thick alumina thin film substrates must be used, the die should be raised 0.150mm (6 mils) so that the surface of the die is coplanar with the surface of the substrate. One way to accomplish this is to attach the 0.102mm (4 mil) thick die to a 0.150mm (6 mil) thick molybdenum heat spreader (moly-tab) which is then attached to the ground plane (Figure 2).

Microstrip substrates should be brought as close to the die as possible in order to minimize bond wire length. Typical die-to-substrate spacing is 0.076mm to 0.152 mm (3 to 6 mils).

### Handling Precautions

Follow these precautions to avoid permanent damage.

**Storage:** All bare die are placed in either Waffle or Gel based ESD protective containers, and then sealed in an ESD protective bag for shipment. Once the sealed ESD protective bag has been opened, all die should be stored in a dry nitrogen environment.

**Cleanliness:** Handle the chips in a clean environment. DO NOT attempt to clean the chip using liquid cleaning systems.

**Static Sensitivity:** Follow ESD precautions to protect against ESD strikes.

**Transients:** Suppress instrument and bias supply transients while bias is applied. Use shielded signal and bias cables to minimize inductive pick-up.

**General Handling:** Handle the chip along the edges with a vacuum collet or with a sharp pair of bent tweezers. The surface of the chip may have fragile air bridges and should not be touched with vacuum collet, tweezers, or fingers.

### Mounting

The chip is back-metallized and can be die mounted with AuSn eutectic preforms or with electrically conductive epoxy. The mounting surface should be clean and flat.

**Eutectic Die Attach:** A 80/20 gold tin preform is recommended with a work surface temperature of 255 °C and a tool temperature of 265 °C. When hot 90/10 nitrogen/hydrogen gas is applied, tool tip temperature should be 290 °C. DO NOT expose the chip to a temperature greater than 320 °C for more than 20 seconds. No more than 3 seconds of scrubbing should be required for attachment.

**Epoxy Die Attach:** Apply a minimum amount of epoxy to the mounting surface so that a thin epoxy fillet is observed around the perimeter of the chip once it is placed into position. Cure epoxy per the manufacturer's schedule.

### Wire Bonding

Ball or wedge bond with 0.025mm (1 mil) diameter pure gold wire. Thermosonic wirebonding with a nominal stage temperature of 150 °C and a ball bonding force of 40 to 50 grams or wedge bonding force of 18 to 22 grams is recommended. Use the minimum level of ultrasonic energy to achieve reliable wirebonds. Wirebonds should be started on the chip and terminated on the package or substrate. All bonds should be as short as possible <0.31mm (12 mils).

