

### Features

- LO 2 TO 24 GHz
- RF 2 TO 24 GHz
- IF 0.1 TO 5 GHz
- LO DRIVE: +10 dBm (NOMINAL)
- HIGH COMPRESSION POINT
- VERY WIDE BANDWIDTH

### Description

The M52 is a triple balanced mixer, designed for use in military, commercial and test equipment applications. The design utilizes Schottky ring quad diodes and broadband soft dielectric baluns to attain excellent performance. The use of high temperature solder and welded assembly processes used internally makes it ideal for use in manual, semi-automated assembly. Environmental screening available to MIL-STD-883, MIL-STD-202 or MIL-DTL-28837, consult factory.

### Product Image

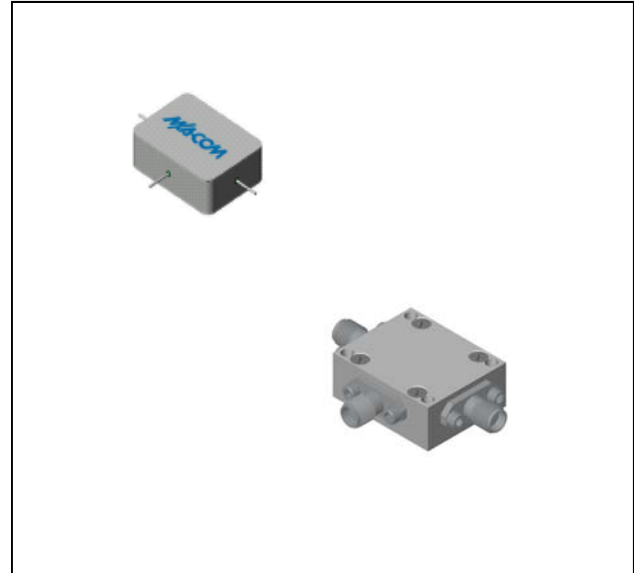

### Ordering Information

Part Number	Package
M52	Minpac
M52C	SMA Connectorized

### Electrical Specifications: $Z_0 = 50\Omega$ $Lo = +10$ dBm (Downconverter application only)

Parameter	Test Conditions	Units	Typical	Guaranteed	
				+25°C	-54° to +85°C *
SSB Conversion Loss (max) & SSB Noise Figure (max)	fR = 8 to 18 GHz, fL = 8 to 18 GHz, fl = 0.1 to 4 GHz	dB	7.5	9.5	10.0
	fR = 2 to 8 GHz, fL = 2 to 8 GHz, fl = 1 to 4 GHz	dB	8.0	10.0	10.5
	fR = 2 to 18 GHz, fL = 2 to 18 GHz, fl = 0.1 to 5 GHz	dB	8.5	10.5	11.0
	fR = 18 to 24 GHz, fL = 13 to 24 GHz, fl = 0.1 to 5 GHz	dB	9.5	12.5	13.0
Isolation, L to R (min)	fL = 2 to 24 GHz	dB	18	15	13
	fL = 4 to 19 GHz	dB	25	20	18
Isolation, L to I (min)	fL = 2 to 20 GHz	dB	30	22	20
	fL = 20 to 24 GHz	dB	20	15	13
1 dB Conversion Comp.	fL @ +10 dBm	dBm	+5		
Input IP3	fR1 = 3.75 GHz @ -6 dBm, fR2 = 3.76 GHz @ -6 dBm, fL = 4 GHz @ 10 dBm	dBm	+16		
	fR1 = 13 GHz @ -6 dBm, fR2 = 13.01 GHz @ -6 dBm, fL = 11 GHz @ 10 dBm	dBm	+16		
	fR1 = 20 GHz @ -6 dBm, fR2 = 20.01 GHz @ -6 dBm, fL = 24 GHz @ 10 dBm	dBm	+13		

\* The M52C specification limits apply at 0°C to +50°C.

### Typical Performance Curves

Conversion Loss vs. Frequency

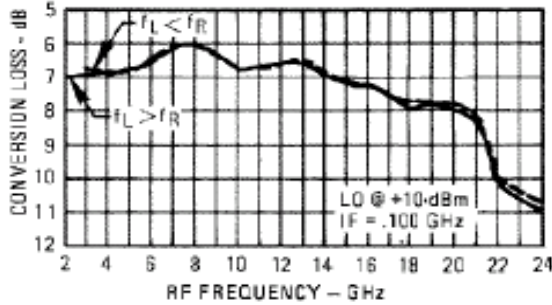

I-Port VSWR

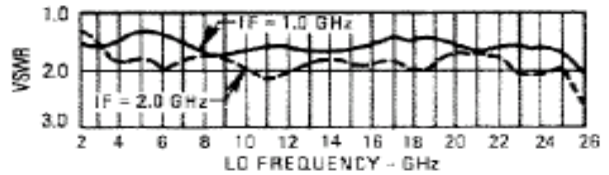
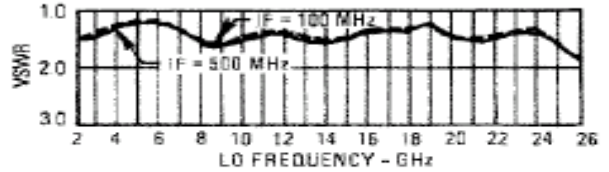

Conversion Loss vs. Frequency

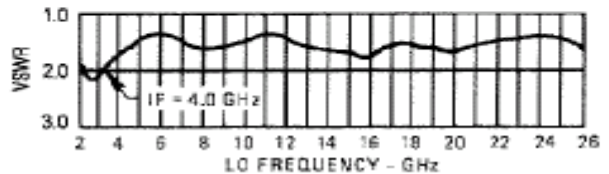
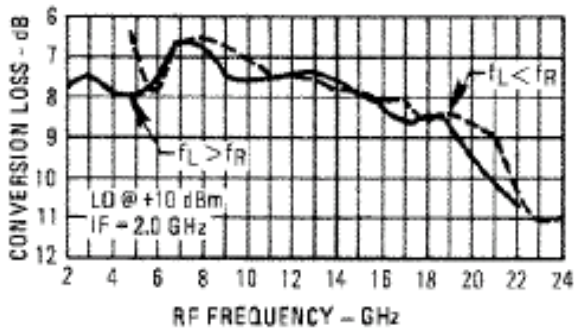

Isolation vs. Frequency

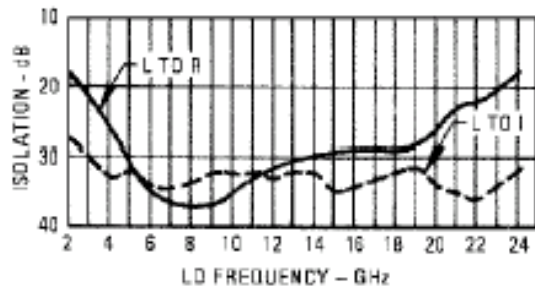

Conversion Loss vs. Frequency

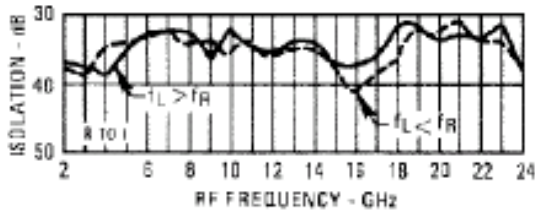
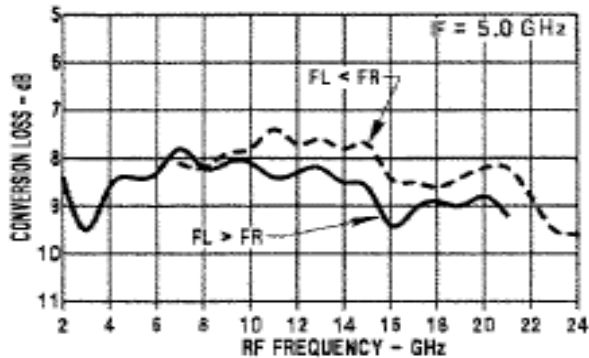

# M52 / M52C

## Triple-Balanced Mixer

Rev. V3

### Absolute Maximum Ratings

Parameter	Absolute Maximum
Operating Temperature	-54°C to +100°C
Storage Temperature	-65°C to +100°C
Peak Input Power	+26 dBm max @ +25°C +22 dBm max @ +100°C
Peak Input Current	mA DC

### Outline Drawing: Minpac \*

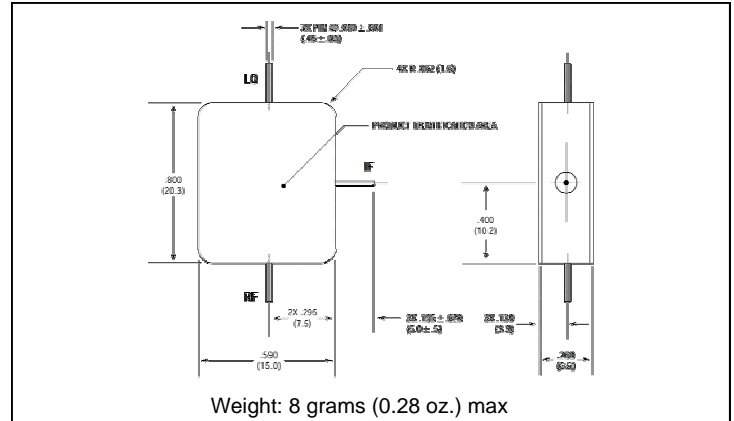

### Outline Drawing: SMA Connectorized \*

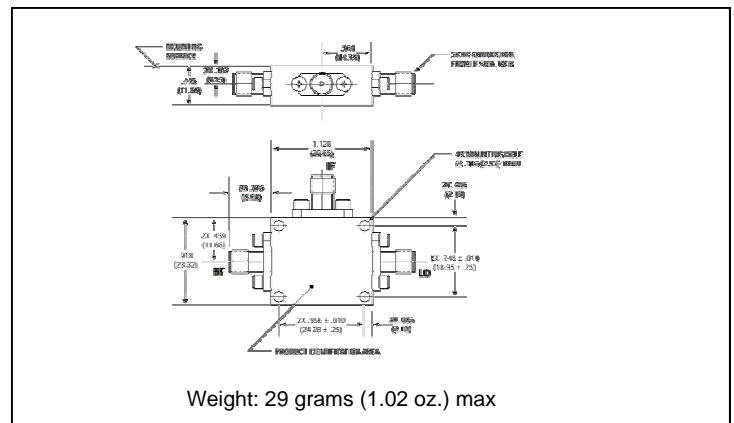

\* Dimensions are inches (millimeters) ±0.015 (0.38) unless otherwise specified.

R-Port VSWR

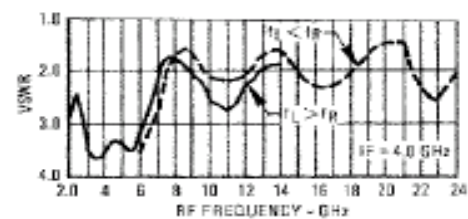
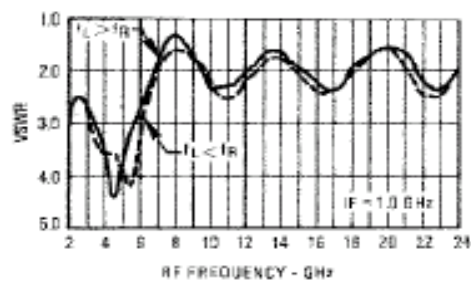
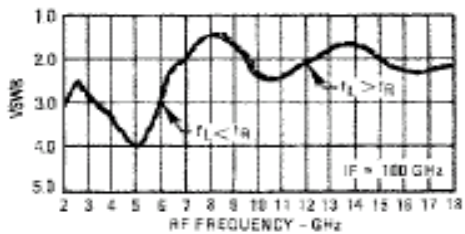

L-Port VSWR

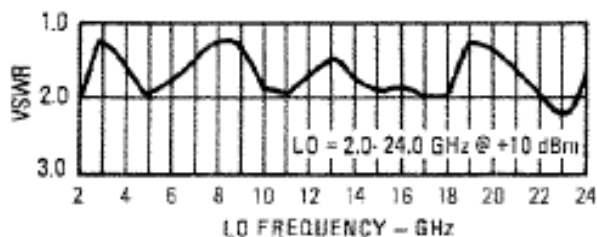

Drive Level

