



maxiFLOW™ Heat Sink for Eighth Brick DC-DC Converter

ATS PART # ATS-1179-C1-R0

Features & Benefits

- » High performance maxiFLOW™ design features less pressure drop and more surface area that maximizes the effective convection (air) cooling
- » Hole pattern fits standard eighth power brick modules
- » Pre-assembled with Chomerics T766 phase change material
- » Heat sink assembly packaged with 3 sets of screws (M3 Philips Pan Head) at 5, 6 and 8 mm lengths

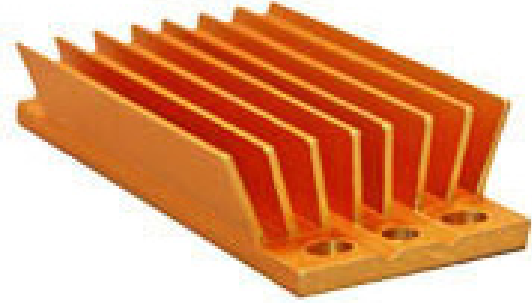

**Image is for illustration purposes only.*

Assembly Part Number	Length (mm)
4 Screws per Set	
ATS-1179-C2-R0	5
ATS-1179-C3-R0	6
ATS-1179-C4-R0	8

Thermal Performance

AIR VELOCITY		6.19THERMAL RESISTANCE	
FT/MIN	M/S	°C/W (UNDUCTED FLOW)	°C/W (DUCTED FLOW)
200	1.0	7.29	3.43
300	1.5	4.90	
400	2.0	3.96	
500	2.5	3.44	
600	3.0	3.10	
700	3.5	2.86	
800	4.0	2.66	

Product Details

DIMENSION A	DIMENSION B	DIMENSION C	DIMENSION D	DIMENSION E	DIMENSION F	DIMENSION G	DIMENSION H	DIMENSION I	INTERFACE MATERIAL	FINISH
59.00 mm	23.00 mm	11.40 mm	30.20 mm	15.20 mm	50.80 mm	12.80 mm	50.40 mm	51.30 mm	CHOMERICS T766	GOLD ANODIZED

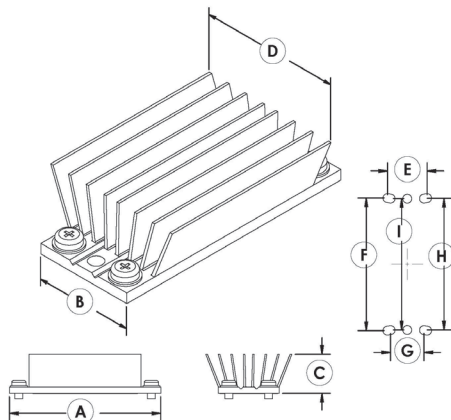

NOTES:

- 1) Thermal performance data are provided for reference only. Actual performance may vary by application.
- 2) ATS reserves the right to update or change its products without notice to improve the design or performance.
- 3) Standard lead time is 4-6 weeks ARO.
- 4) Contact ATS to learn about custom options available.
- 5) Dimension D = heat sink height from bottom of the base to the top of the fin field.
- 6) Dimension E = Hole Width
- 7) Dimension F = Hole Length
- 8) Dimension G = Short Hole Width
- 9) Dimension H = Short Hole Length
- 10) Dimension I = Center Hole



ATS ADVANCED THERMAL SOLUTIONS, INC.
Innovations in Thermal Management®

For further technical information, please contact Advanced Thermal Solutions, Inc.

89-27 ACCESS ROAD, NORWOOD, MA 02062 USA | T: 781.769.2800 F: 781.769.9979 | WWW.QATS.COM

REV2_0114