

STRADA-2X2-CAT

Catenary street light beam optimized for EN13201 M-classes

TECHNICAL SPECIFICATIONS:

Dimensions	50.0 mm
Height	6.2 mm
Fastening	glue, pin, screw
ROHS compliant	yes ⓘ

MATERIAL SPECIFICATIONS:

Component	Type	Material	Colour	Finish
STRADA-2X2-CAT	Multi-lens	PMMA	clear	







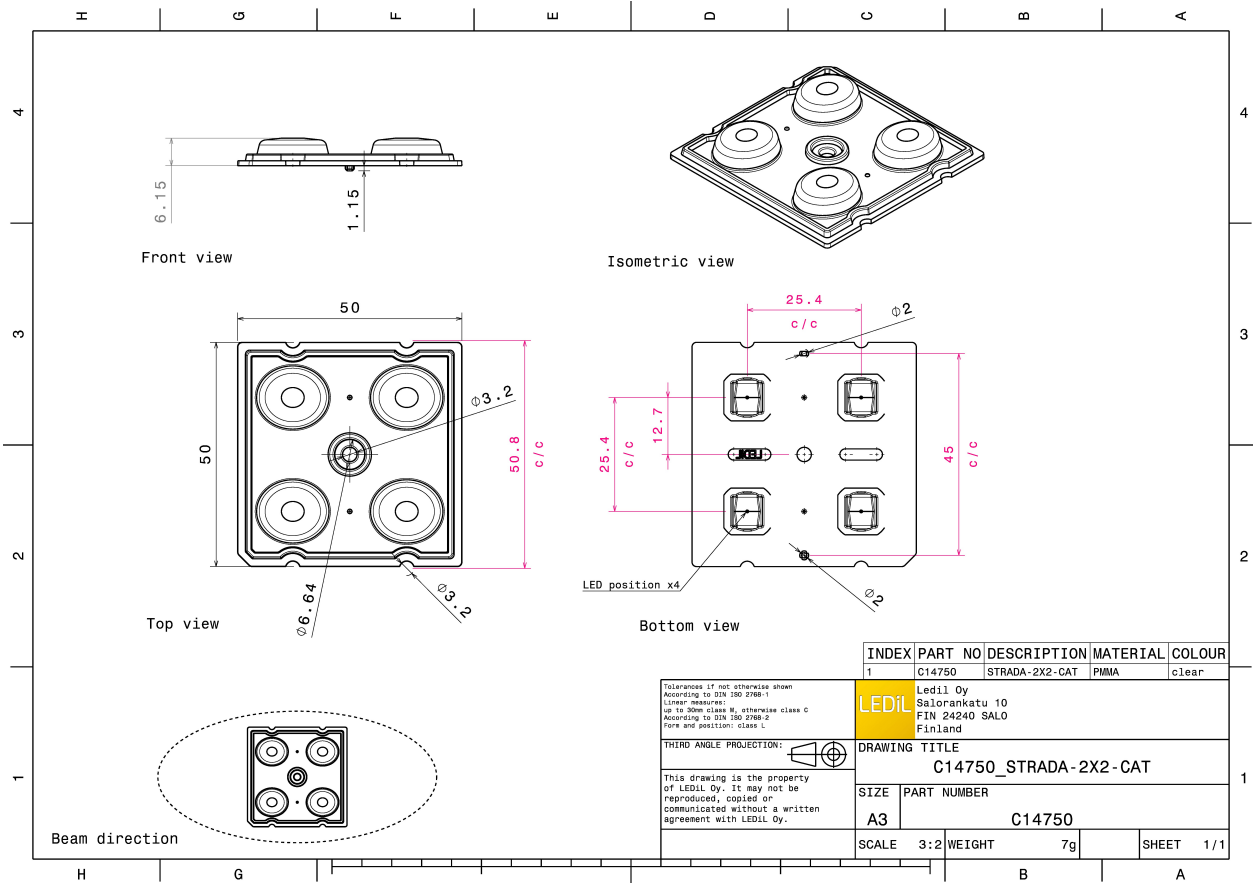

ORDERING INFORMATION:

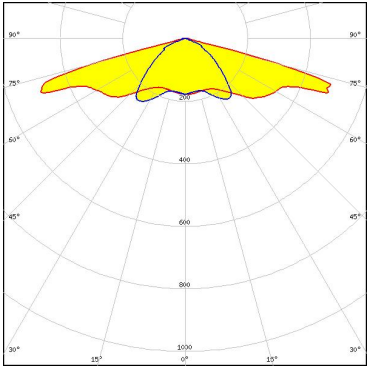
Component	Qty in box	MOQ	MPQ	Box weight (kg)
C14750_STRADA-2X2-CAT » Box size: 480 x 280 x 300 mm	800	160	160	6.3

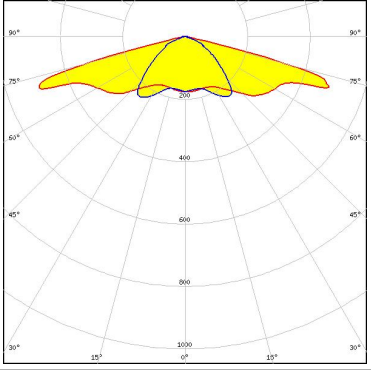

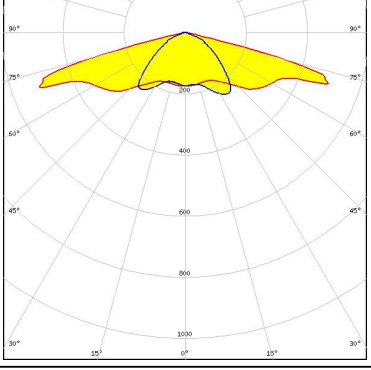
PHOTOMETRIC DATA (MEASURED):

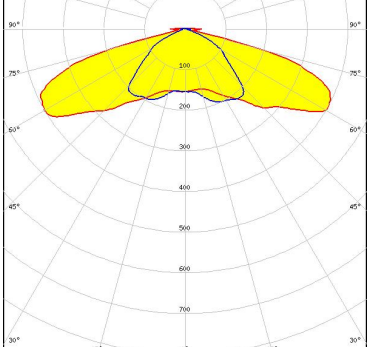
 <p> LED QUICK FLUX XTP 2x4 xxx LS G5 FWHM 152.0 + 117.0° Efficiency 94 % Peak intensity 0.5 cd/lm LEDs/each optic 1 Light colour White Required components: </p>	
 <p> LED QUICK FLUX XTP 2x6 xxx LS G5 FWHM 153.0 + 118.0° Efficiency 94 % Peak intensity 0.5 cd/lm LEDs/each optic 1 Light colour White Required components: </p>	
 <p> LED QUICK FLUX XTP 2x8 xxx LS G5 FWHM 152.0 + 118.0° Efficiency 94 % Peak intensity 0.5 cd/lm LEDs/each optic 1 Light colour White Required components: </p>	
 <p> LED XD16 FWHM 150.0 + 126.0° Efficiency 94 % Peak intensity 0.4 cd/lm LEDs/each optic 4 Light colour White Required components: </p>	



PHOTOMETRIC DATA (MEASURED):

CREE

LED XD16
 FWHM 148.0 + 133.0°
 Efficiency 94 %
 Peak intensity 0.6 cd/lm
 LEDs/each optic 1
 Light colour White
 Required components:

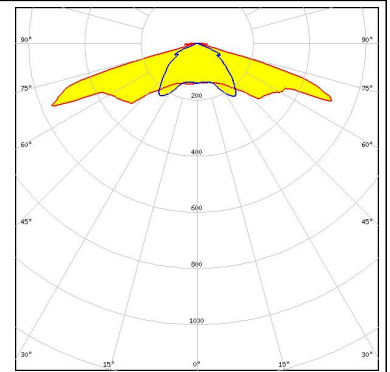

CREE

LED XP-G2
 FWHM 153.0 + 118.0°
 Efficiency 94 %
 Peak intensity 0.4 cd/lm
 LEDs/each optic 1
 Light colour White
 Required components:

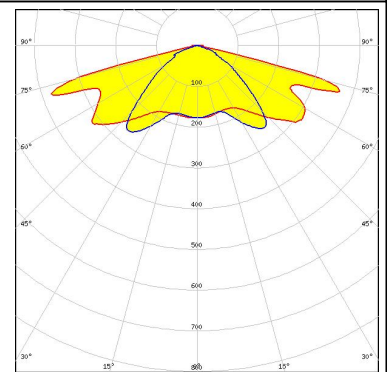

CREE

LED XP-G2 HE
 FWHM Asymmetric
 Efficiency 94 %
 Peak intensity 0.4 cd/lm
 LEDs/each optic 1
 Light colour White
 Required components:

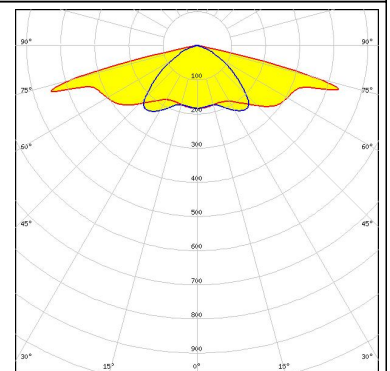

CREE

LED XP-G3
 FWHM Asymmetric
 Efficiency 94 %
 Peak intensity 0.4 cd/lm
 LEDs/each optic 1
 Light colour White
 Required components:

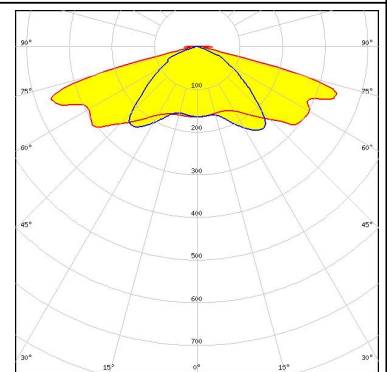

PHOTOMETRIC DATA (MEASURED):



LED XP-L HI
 FWHM 153.0 + 118.0°
 Efficiency 94 %
 Peak intensity 0.4 cd/lm
 LEDs/each optic 1
 Light colour White
 Required components:

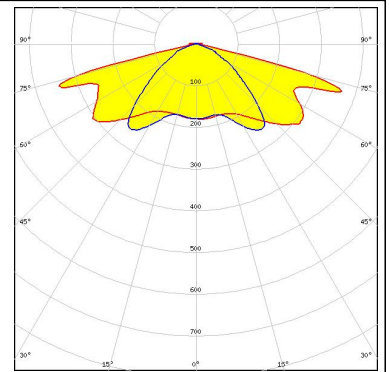

LED H35C1 (LEMWA33)
 FWHM 154.0 + 116.0°
 Efficiency 94 %
 Peak intensity 0.3 cd/lm
 LEDs/each optic 1
 Light colour White
 Required components:

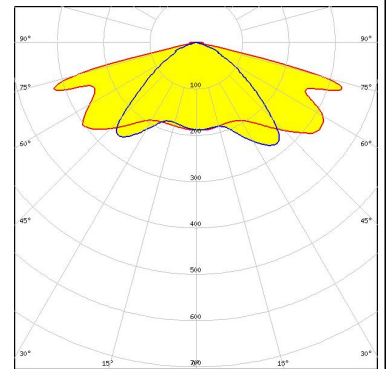

LED LUXEON 5050 Round LES
 FWHM 149.0 + 119.0°
 Efficiency 94 %
 Peak intensity 0.4 cd/lm
 LEDs/each optic 1
 Light colour White
 Required components:

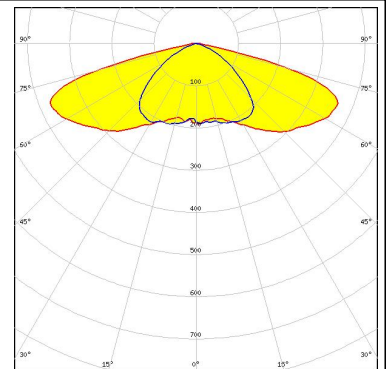

LED LUXEON V
 FWHM 152.0 + 117.0°
 Efficiency 94 %
 Peak intensity 0.3 cd/lm
 LEDs/each optic 1
 Light colour White
 Required components:

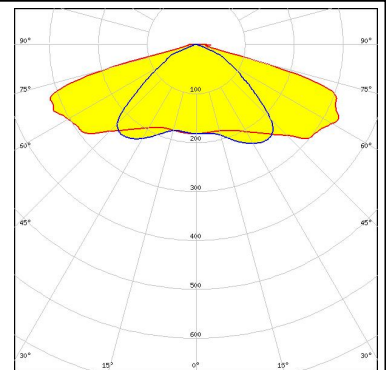
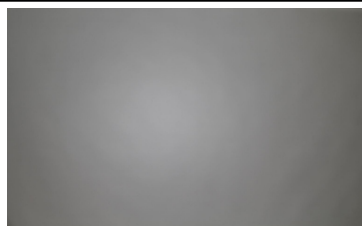

PHOTOMETRIC DATA (MEASURED):



LED NVSW219F
FWHM 154.0 + 118.0°
Efficiency 94 %
Peak intensity 0.4 cd/lm
LEDs/each optic 1
Light colour White
Required components:

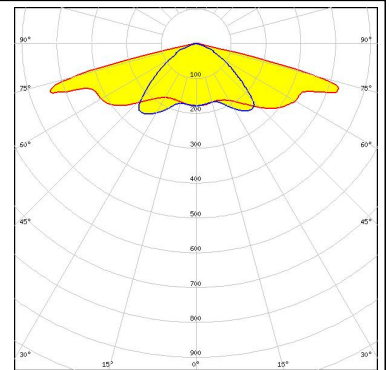

LED NVSW319B
FWHM 155.0 + 120.0°
Efficiency 94 %
Peak intensity 0.5 cd/lm
LEDs/each optic 1
Light colour White
Required components:

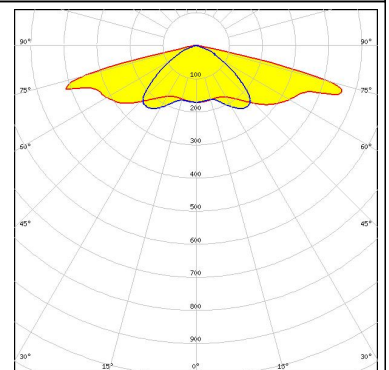

LED NVSW3x9A
FWHM 152.0 + 125.0°
Efficiency 94 %
Peak intensity 0.5 cd/lm
LEDs/each optic 1
Light colour White
Required components:

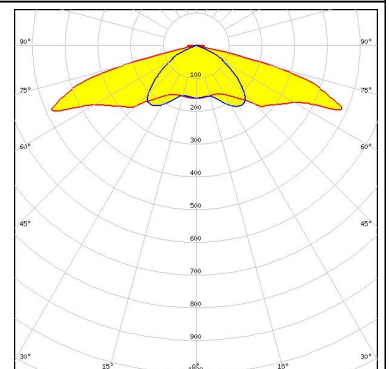
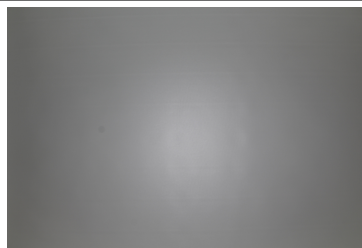

LED NVSxE21A
FWHM 142.0 + 130.0°
Efficiency 94 %
Peak intensity 0.5 cd/lm
LEDs/each optic 1
Light colour White
Required components:

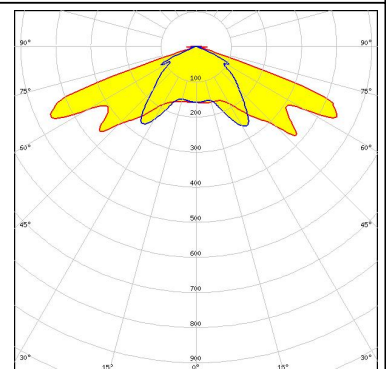

PHOTOMETRIC DATA (MEASURED):

OSRAM

LED PrevaLED Brick HP 2x8
 FWHM 152.0 + 119.0°
 Efficiency 94 %
 Peak intensity 0.4 cd/lm
 LEDs/each optic 1
 Light colour White
 Required components:

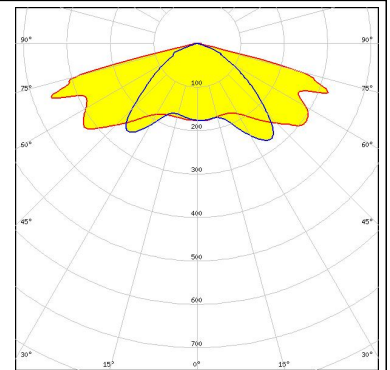

OSRAM

Opto Semiconductors

LED Duris S8
 FWHM 150.0 + 117.0°
 Efficiency 94 %
 Peak intensity 0.4 cd/lm
 LEDs/each optic 1
 Light colour White
 Required components:

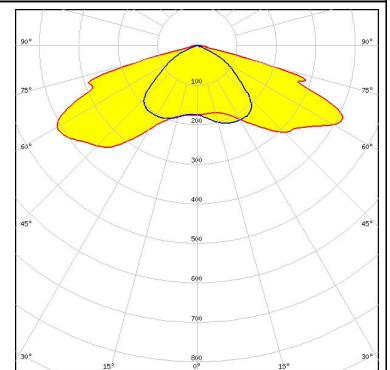

OSRAM

Opto Semiconductors

LED OSLON Square CSSRM2/CSSRM3
 FWHM 152.0 + 119.0°
 Efficiency 94 %
 Peak intensity 0.4 cd/lm
 LEDs/each optic 1
 Light colour White
 Required components:

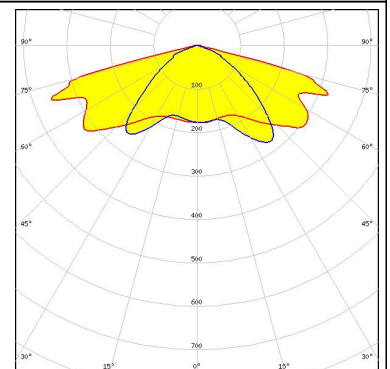

OSRAM

Opto Semiconductors

LED OSLON Square PC
 FWHM Asymmetric
 Efficiency 94 %
 Peak intensity 0.5 cd/lm
 LEDs/each optic 1
 Light colour White
 Required components:

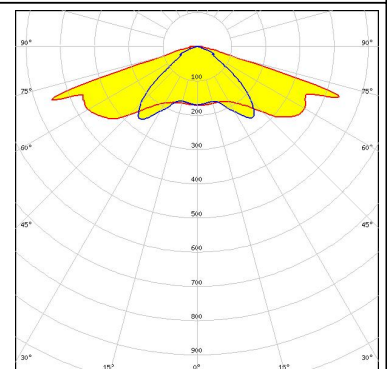

PHOTOMETRIC DATA (MEASURED):

PHILIPS

LED Fortimo FastFlex LED 2x8 DA G4
FWHM 117.0 + 153.0°
Efficiency 94 %
Peak intensity 0.5 cd/lm
LEDs/each optic 1
Light colour White
Required components:

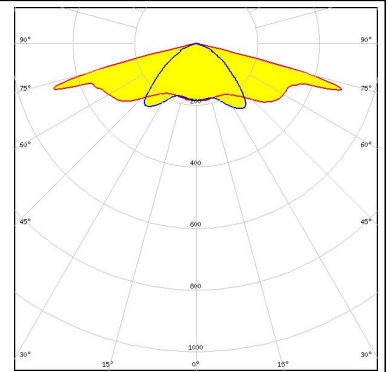

PHILIPS

LED Fortimo FastFlex LED 2x8 DA G4+
FWHM Asymmetric
Efficiency 94 %
Peak intensity 0.4 cd/lm
LEDs/each optic 1
Light colour White
Required components:

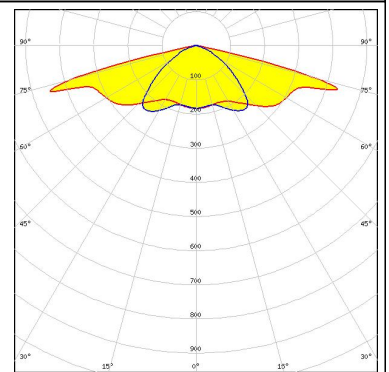

SAMSUNG

LED HiLOM RH16 (LH351C)
FWHM Asymmetric
Efficiency 94 %
Peak intensity 0.4 cd/lm
LEDs/each optic 1
Light colour White
Required components:

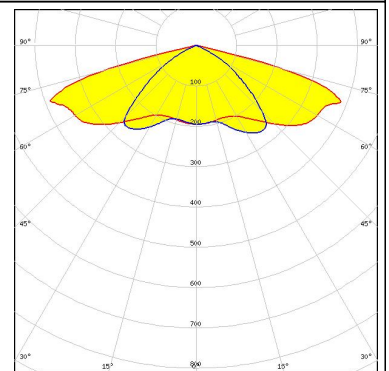

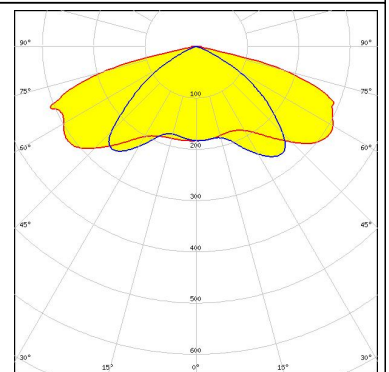

SAMSUNG

LED LH351B
FWHM 154.0 + 119.0°
Efficiency 94 %
Peak intensity 0.3 cd/lm
LEDs/each optic 1
Light colour White
Required components:

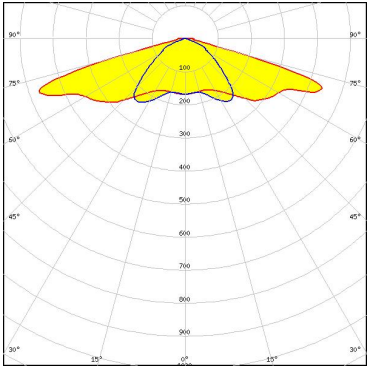
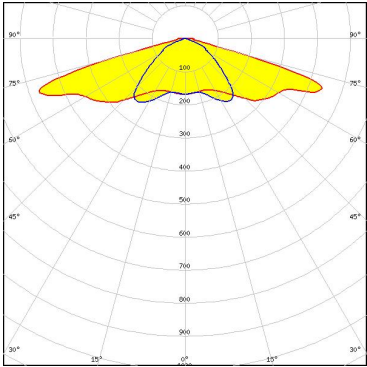

PHOTOMETRIC DATA (MEASURED):

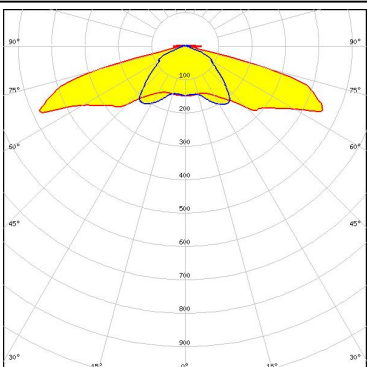
<p>SEOUL SEMICONDUCTOR</p> <p>LED Z5M3 FWHM Asymmetric Efficiency 94 % Peak intensity 0.5 cd/lm LEDs/each optic 1 Light colour White Required components:</p>		
<p>SEOUL SEMICONDUCTOR</p> <p>LED Z8Y22 FWHM 143.0 + 128.0° Efficiency 94 % Peak intensity 0.5 cd/lm LEDs/each optic 1 Light colour White Required components:</p>		
<p>SEOUL SEMICONDUCTOR</p> <p>LED Z8Y22P FWHM 151.0 + 130.0° Efficiency 94 % Peak intensity 0.5 cd/lm LEDs/each optic 1 Light colour White Required components:</p>		
<p>TRIDONIC</p> <p>LED RLE 2x4 2000lm HP EXC2 OTD FWHM 151.0 + 119.0° Efficiency 94 % Peak intensity 0.6 cd/lm LEDs/each optic 1 Light colour White Required components:</p>		

PHOTOMETRIC DATA (MEASURED):

TRIDONIC

LED RLE 2x8 4000lm HP EXC2 OTD
FWHM 151.0 + 119.0°
Efficiency 94 %
Peak intensity 0.6 cd/lm
LEDs/each optic 1
Light colour White
Required components:

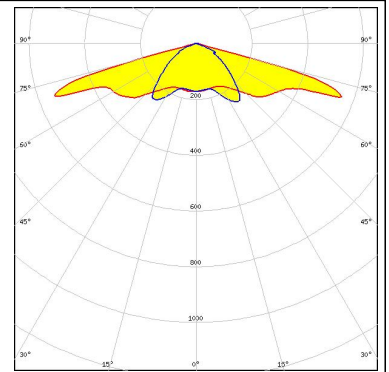

TRIDONIC

LED RLE G1 49x121mm 2000lm xxx EXC OTD
FWHM 147.0 + 107.0°
Efficiency 94 %
Peak intensity 0.4 cd/lm
LEDs/each optic 1
Light colour White
Required components:

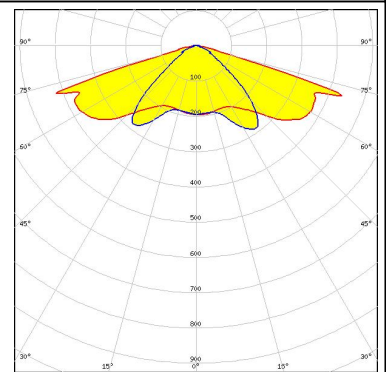

TRIDONIC

LED RLE G1 49x133mm 2000lm xxx EXC OTD
FWHM 147.0 + 107.0°
Efficiency 94 %
Peak intensity 0.4 cd/lm
LEDs/each optic 1
Light colour White
Required components:

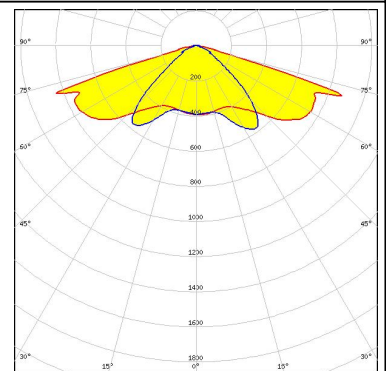

TRIDONIC

LED RLE G1 49x223mm 4000lm xxx EXC OTD
FWHM 147.0 + 107.0°
Efficiency 94 %
Peak intensity 0.4 cd/lm
LEDs/each optic 1
Light colour White
Required components:

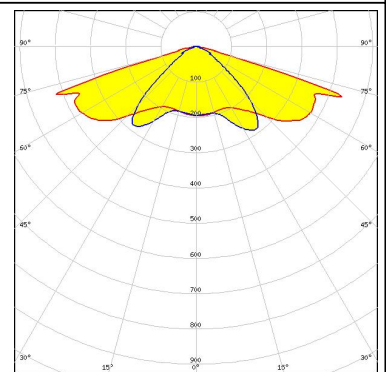

PHOTOMETRIC DATA (MEASURED):

TRIDONIC

LED RLE G1 49x245mm 4000lm xxx EXC OTD
FWHM 147.0 + 107.0°
Efficiency 94 %
Peak intensity 0.4 cd/lm
LEDs/each optic 1
Light colour White
Required components:

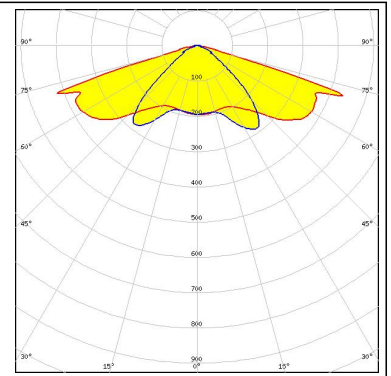

PHOTOMETRIC DATA (SIMULATED):



LED XB-D
FWHM 154.0 + 107.0°
Efficiency 91 %
Peak intensity 0.5 cd/lm
LEDs/each optic 1
Light colour White
Required components:

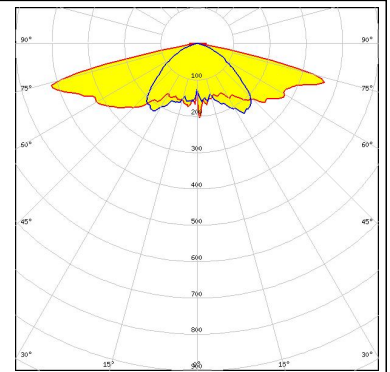

LED XM-L
FWHM 109.0 + 152.0°
Efficiency 93 %
Peak intensity 0.4 cd/lm
LEDs/each optic 1
Light colour White
Required components:

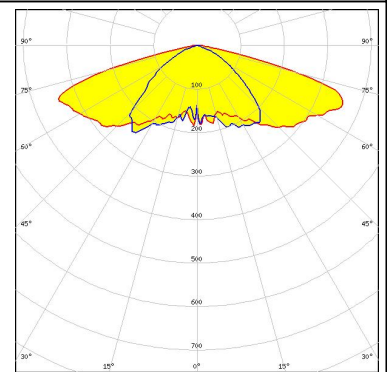

LED XM-L2
FWHM 153.0 + 112.0°
Efficiency 93 %
Peak intensity 0.4 cd/lm
LEDs/each optic 1
Light colour White
Required components:

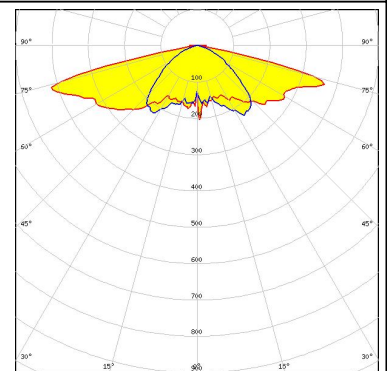

LED XP-G
FWHM 156.0 + 112.0°
Efficiency 92 %
Peak intensity 0.4 cd/lm
LEDs/each optic 1
Light colour White
Required components:

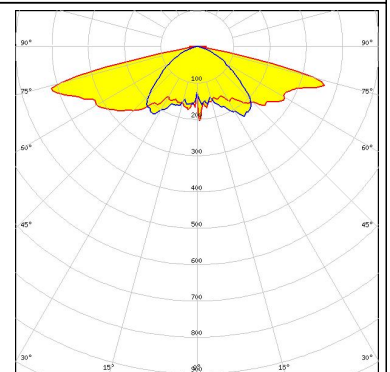

PHOTOMETRIC DATA (SIMULATED):



LED XP-G2 HE
 FWHM Asymmetric
 Efficiency 94 %
 Peak intensity 0.3 cd/lm
 LEDs/each optic 1
 Light colour White
 Required components:

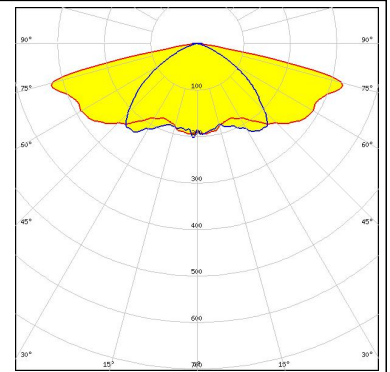

LED XP-G3
 FWHM 154.0 + 112.0°
 Efficiency 82 %
 Peak intensity 0.3 cd/lm
 LEDs/each optic 1
 Light colour White
 Required components:

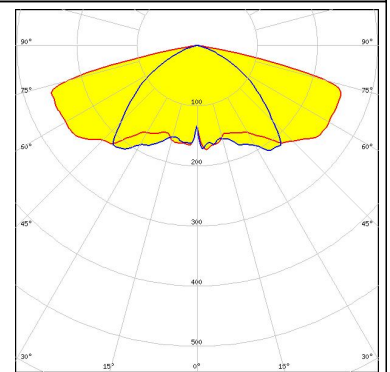

Transparent protective cover



LED XP-L HD
 FWHM 155.0 + 109.0°
 Efficiency 91 %
 Peak intensity 0.3 cd/lm
 LEDs/each optic 1
 Light colour White
 Required components:

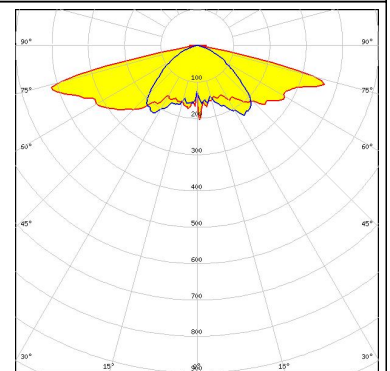

LED XT-E
 FWHM 155.0 + 110.0°
 Efficiency 91 %
 Peak intensity 0.4 cd/lm
 LEDs/each optic 1
 Light colour White
 Required components:

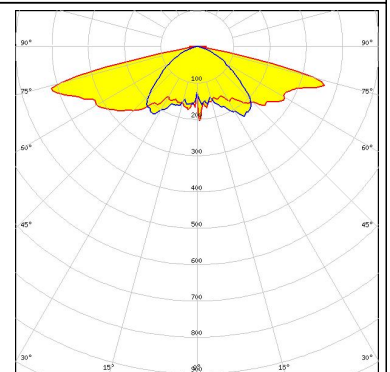

PHOTOMETRIC DATA (SIMULATED):



LED XT-E
FWHM 153.0 + 110.0°
Efficiency 95 %
Peak intensity 0.5 cd/lm
LEDs/each optic 1
Light colour White
Required components:

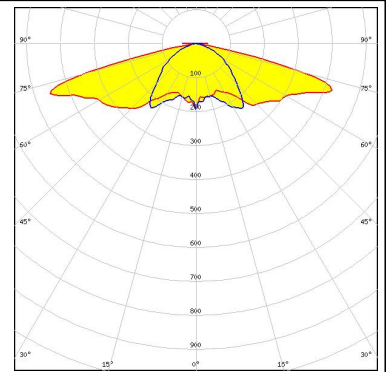

LED XT-E HVW
FWHM 155.0 + 110.0°
Efficiency 92 %
Peak intensity 0.4 cd/lm
LEDs/each optic 1
Light colour White
Required components:

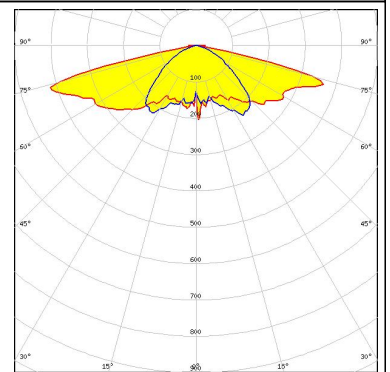

LED LUXEON 5050 Square LES
FWHM 152.0 + 112.0°
Efficiency 96 %
Peak intensity 0.4 cd/lm
LEDs/each optic 1
Light colour White
Required components:

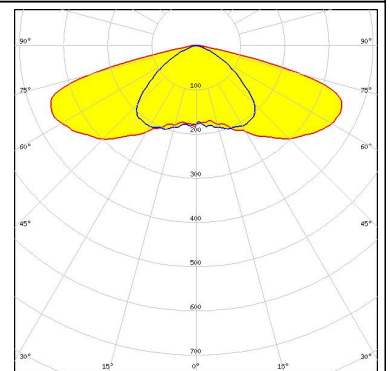

LED LUXEON R
FWHM 150.0 + 107.0°
Efficiency 92 %
Peak intensity 0.4 cd/lm
LEDs/each optic 1
Light colour White
Required components:

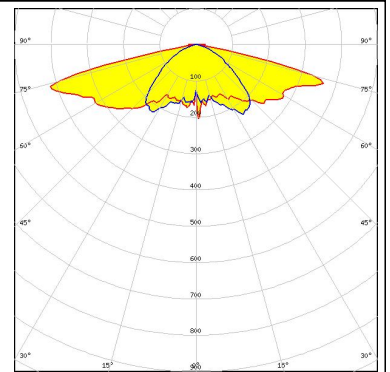

PHOTOMETRIC DATA (SIMULATED):

LUMILEDS

LED LUXEON Rebel ES
 FWHM 151.0 + 106.0°
 Efficiency 92 %
 Peak intensity 0.4 cd/lm
 LEDs/each optic 1
 Light colour White
 Required components:

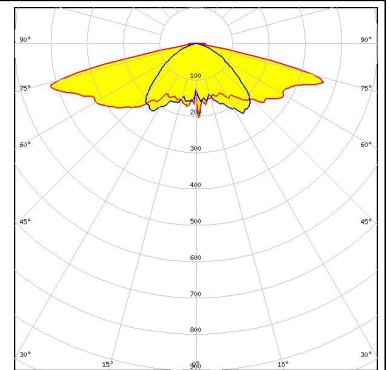

LUMILEDS

LED LUXEON T
 FWHM 154.0 + 110.0°
 Efficiency 96 %
 Peak intensity 0.4 cd/lm
 LEDs/each optic 1
 Light colour White
 Required components:

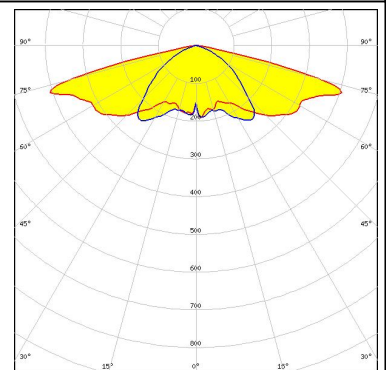

LUMILEDS

LED LUXEON TX
 FWHM 153.0 + 108.0°
 Efficiency 92 %
 Peak intensity 0.5 cd/lm
 LEDs/each optic 1
 Light colour White
 Required components:

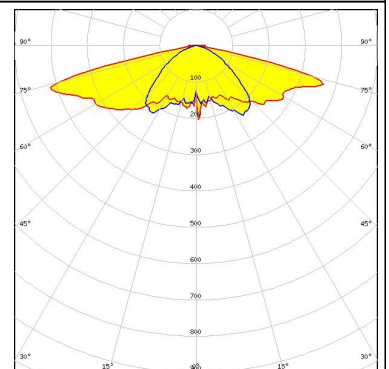

LUMILEDS

LED LUXEON V2
 FWHM 154.0 + 110.0°
 Efficiency 94 %
 Peak intensity 0.4 cd/lm
 LEDs/each optic 1
 Light colour White
 Required components:

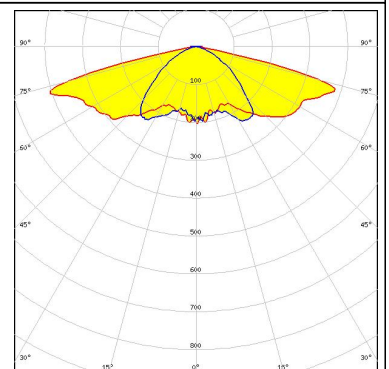

PHOTOMETRIC DATA (SIMULATED):



LED NCSxx19B
FWHM 152.0 + 111.0°
Efficiency 91 %
Peak intensity 0.5 cd/lm
LEDs/each optic 1
Light colour White
Required components:

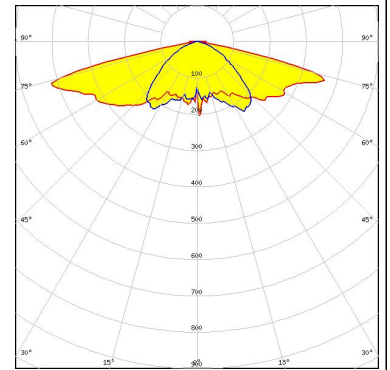

LED NV4WB35AM
FWHM Asymmetric
Efficiency 96 %
Peak intensity 0.4 cd/lm
LEDs/each optic 1
Light colour White
Required components:

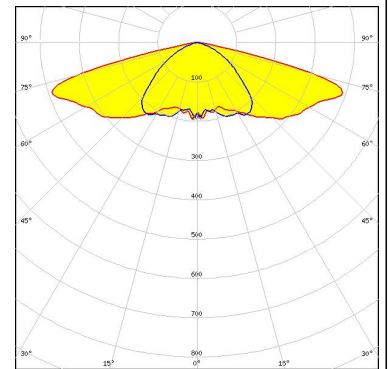

LED NVSxE21A
FWHM 105.0 + 146.0°
Efficiency 84 %
Peak intensity 0.4 cd/lm
LEDs/each optic 1
Light colour White
Required components:

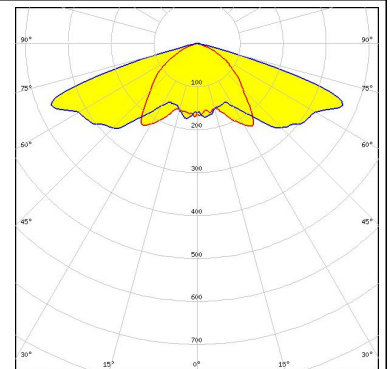

Transparent protective cover



LED NVSxx19B/NVSxx19C
FWHM Asymmetric
Efficiency 92 %
Peak intensity 0.4 cd/lm
LEDs/each optic 1
Light colour White
Required components:

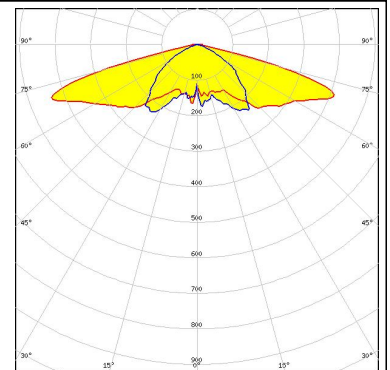

PHOTOMETRIC DATA (SIMULATED):

OSRAM Opto Semiconductors

LED Duris S8
 FWHM Asymmetric
 Efficiency 86 %
 Peak intensity 0.4 cd/lm
 LEDs/each optic 1
 Light colour White
 Required components:

Transparent protective cover

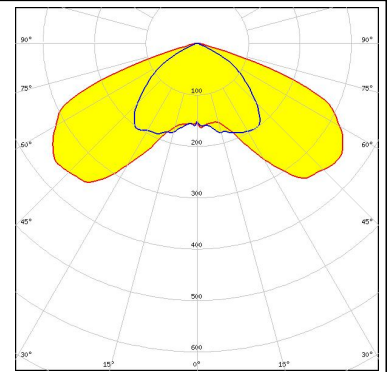

OSRAM Opto Semiconductors

LED OSCONIQ P 3737 (3W version)
 FWHM 153.0 + 92.0°
 Efficiency 94 %
 Peak intensity 0.4 cd/lm
 LEDs/each optic 1
 Light colour White
 Required components:

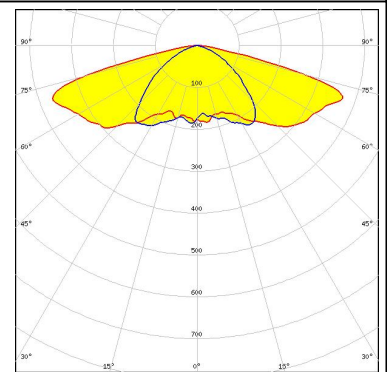

OSRAM Opto Semiconductors

LED OSLOM Square CSSRM2/CSSRM3
 FWHM 148.0 + 116.0°
 Efficiency 82 %
 LEDs/each optic 1
 Light colour White
 Required components:

Transparent protective cover

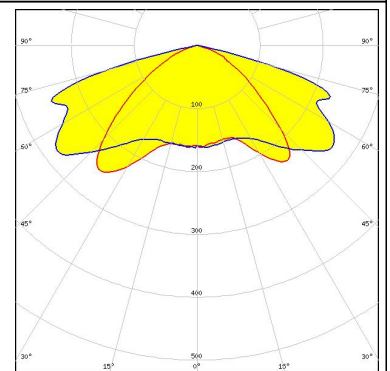

OSRAM Opto Semiconductors

LED OSLOM Square CSSRM2/CSSRM3
 FWHM Asymmetric
 Efficiency 85 %
 Peak intensity 0.4 cd/lm
 LEDs/each optic 1
 Light colour White
 Required components:

Transparent protective cover

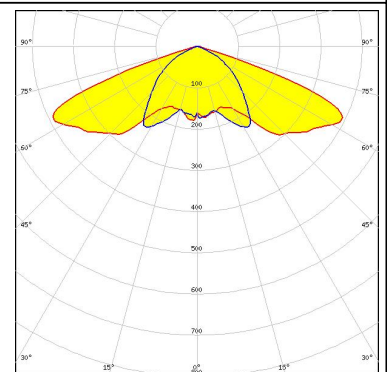

PHOTOMETRIC DATA (SIMULATED):

PHILIPS

LED Fortimo FastFlex LED 2x8 DAX G4
FWHM 157.0 + 94.0°
Efficiency 94 %
Peak intensity 0.4 cd/lm
LEDs/each optic 1
Light colour White
Required components:

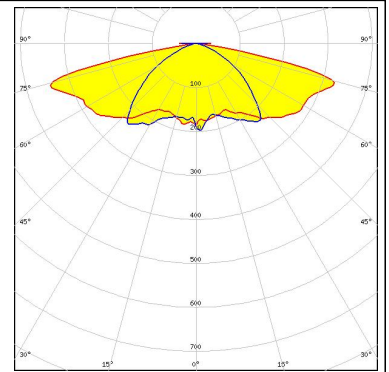

SAMSUNG

LED LH351A
FWHM 158.0 + 116.0°
Efficiency 92 %
Peak intensity 0.4 cd/lm
LEDs/each optic 1
Light colour White
Required components:

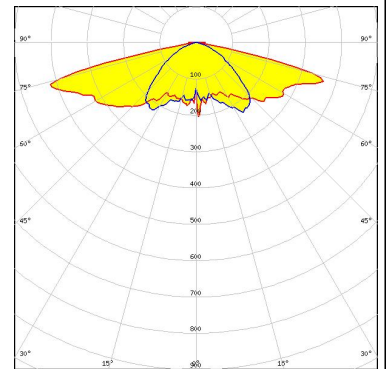

SAMSUNG

LED LH351D
FWHM 153.0 + 113.0°
Efficiency 92 %
Peak intensity 0.3 cd/lm
LEDs/each optic 1
Light colour White
Required components:

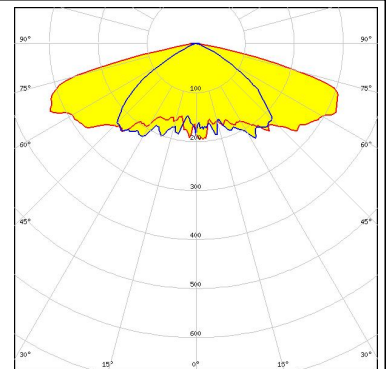

SAMSUNG

LED LH351Z
FWHM 150.0 + 105.0°
Efficiency 93 %
Peak intensity 0.4 cd/lm
LEDs/each optic 1
Light colour White
Required components:

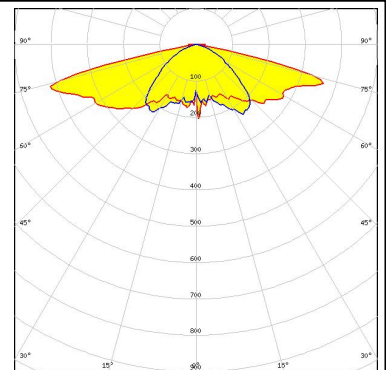

PHOTOMETRIC DATA (SIMULATED):

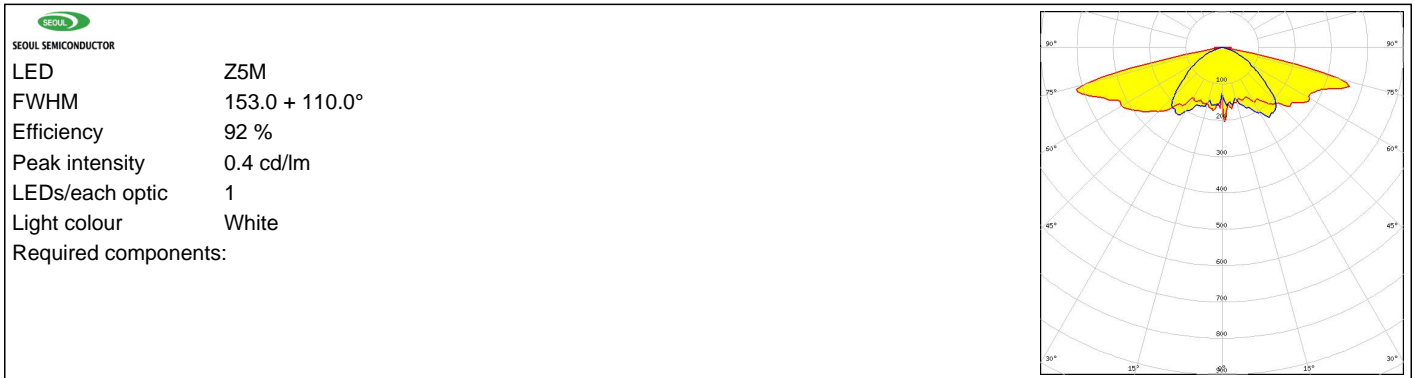

GENERAL INFORMATION:

NOTE: The typical beam angle will be changed by different color, chip size and chip position tolerance. The typical total beam angle is the full angle measured where the luminous intensity is half of the peak value.

MATERIALS:

As part of our continuous research and improvement processes, and to ensure the best possible quality and availability of our products, LEDiL reserves the right to change material grades without notice.

PRODUCT DATA USER AGREEMENT AND DISCLAIMER:

The measured data in the provided downloadable LEDiL Product Datasheets and Mechanical 2D-Drawings is rounded and provided as reference for planning. LEDiL Oy's optical specifications have been verified by conducting performance testing of the products in accordance with the company's quality system. The reported data are averaged results of multiple measurements with typical variation. LEDiL Oy reserves the right to without prior notification make changes and improvements to its products.

LEDiL Oy assumes neither warranty, nor guarantee nor any other liability of any kind for the contents and correctness of the provided data. The provided data has been generated with highest diligence but the provided data may in reality not represent the complete possible variation range of all intrinsic parameters. Therefore, in certain cases a deviation from the provided data could occur.

LEDiL Oy reserves the right to undertake technical changes of its products without further notification which could lead to changes in the provided data. LEDiL Oy assumes no liability of any kind for the possible deviation from any provided data or any other damage resulting from the usage of the provided data.

The user agrees to this disclaimer and user agreement with the download or usage of the provided files.

LEDiL Oy

Joensuunkatu 13
FI-24240 SALO
Finland

LEDiL Inc.

228 West Page Street
Suite D
Sycamore IL 60178
USA

Local sales and technical support

[www.ledil.com/
where_to_buy](http://www.ledil.com/where_to_buy)

Shipping locations

Salo, Finland
Hong Kong, China

Distribution Partners

[www.ledil.com/
where_to_buy](http://www.ledil.com/where_to_buy)