



AC/DC Converter
Non-Isolation Buck Converter PWM method
3 W 18 V
BM2P189TF Reference Board

User's Guide

<High Voltage Safety Precautions>

- ◇ Read all safety precautions before use

Please note that this document covers only the BM2P189TF evaluation board (BM2P189TF-EVK-001) and its functions. For additional information, please refer to the datasheet.

To ensure safe operation, please carefully read all precautions before handling the evaluation board



Depending on the configuration of the board and voltages used,

Potentially lethal voltages may be generated.

Therefore, please make sure to read and observe all safety precautions described in the red box below.

Before Use

- [1] Verify that the parts/components are not damaged or missing (i.e. due to the drops).
- [2] Check that there are no conductive foreign objects on the board.
- [3] Be careful when performing soldering on the module and/or evaluation board to ensure that solder splash does not occur.
- [4] Check that there is no condensation or water droplets on the circuit board.

During Use

- [5] Be careful to not allow conductive objects to come into contact with the board.
- [6] **Brief accidental contact or even bringing your hand close to the board may result in discharge and lead to severe injury or death.**

Therefore, DO NOT touch the board with your bare hands or bring them too close to the board. In addition, as mentioned above please exercise extreme caution when using conductive tools such as tweezers and screwdrivers.

- [7] If used under conditions beyond its rated voltage, it may cause defects such as short-circuit or, depending on the circumstances, explosion or other permanent damages.
- [8] Be sure to wear insulated gloves when handling is required during operation.

After Use

- [9] The ROHM Evaluation Board contains the circuits which store the high voltage. Since it stores the charges even after the connected power circuits are cut, please discharge the electricity after using it, and please deal with it after confirming such electric discharge.
- [10] Protect against electric shocks by wearing insulated gloves when handling.

This evaluation board is intended for use only in research and development facilities and should be handled **only by qualified personnel familiar with all safety and operating procedures.**

We recommend carrying out operation in a safe environment that includes the use of high voltage signage at all entrances, safety interlocks, and protective glasses.

AC/DC Converter Non-Isolation Buck Converter PWM method Output 3 W 18 V **BM2P189TF Reference Board** BM2P189TF-EVK-001

The BM2P189TF-EVK-001 evaluation board outputs 18 V voltage from the input of 90 Vac to 264 Vac. The output current supplies up to 0.167 A. BM2P189TF which is PWM method DC/DC converter IC built-in 650 V MOSFET is used.

The BM2P189TF contributes to low power consumption by built-in a 650 V starting circuit. Built-in current detection resistor realizes compact power supply design.

Current mode control imposes current limitation on every cycle, providing superior performance in bandwidth and transient response.

The switching frequency is 100 kHz in fixed mode. At light load, frequency is reduced and high efficiency is realized. Built-in frequency hopping function contributes to low EMI. Low on-resistance 9.5 Ω 650 V MOSFET built-in contributes to low power consumption and easy design.



Figure 1. BM2P189TF-EVK-001

Electronics Characteristics

Not guarantee the characteristics, is representative value.

Unless otherwise noted : $V_{IN} = 230 \text{ Vac}$, $I_{OUT} = 167 \text{ mA}$, $T_a: 25 \text{ }^\circ\text{C}$

Parameter	Min	Typ	Max	Units	Conditions
Input Voltage Range	90	230	264	Vac	
Input Frequency	47	50/60	63	Hz	
Output Voltage	16.2	18.0	19.8	V	
Maximum Output Power	-	-	3.0	W	$I_{OUT} = 167 \text{ mA}$
Output Current Range (NOTE1)	2	167	167	mA	
Stand-by Power	-	56	-	mW	$I_{OUT} = 0 \text{ A}$
Efficiency	-	82.5	-	%	
Output Ripple Voltage (NOTE2)	-	33	-	mVpp	
Operating Temperature Range	-10	+25	+65	$^\circ\text{C}$	

(NOTE1) Please adjust operating time, within any parts surface temperature under 105 $^\circ\text{C}$

(NOTE2) Not include spike noise

Operation Procedure

1. Operation Equipment

- (1) AC Power supply 90 Vac~264 Vac, over 10W
- (2) Electronic Load capacity 0.167 A
- (3) Multi meter

2. Connect method

- (1) AC power supply presetting range 90~264 Vac, Output switch is off.
- (2) Load setting under 0.167 A. Load switch is off.
- (3) AC power supply N terminal connect to the board AC (N) of CN1, and L terminal connect to AC(L).
- (4) Load + terminal connect to VOUT, GND terminal connect to GND terminal
- (5) AC power meter connect between AC power supply and board.
- (6) Output test equipment connects to output terminal
- (7) AC power supply switch ON.
- (8) Check that output voltage is 18 V.
- (9) Electronic load switch ON
- (10) Check output voltage drop by load connect wire resistance



CN1: from the top AC (L), AC (N)

Figure 2. Connection Circuit

Deleting

Maximum Output Power P_o of this reference board is 3 W. The derating curve is shown on the right. Please adjust load continuous time by over 105 °C of any parts surface temperature.

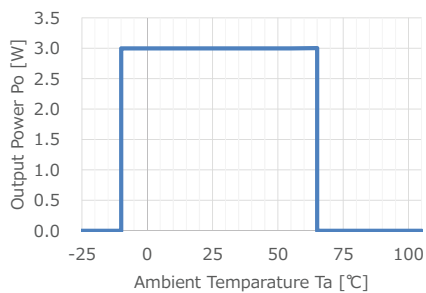

Figure 3. Temperature Derating curve

Application Circuit

$V_{IN} = 90 \sim 264 \text{ Vac}$, $V_{OUT} = 18 \text{ V}$

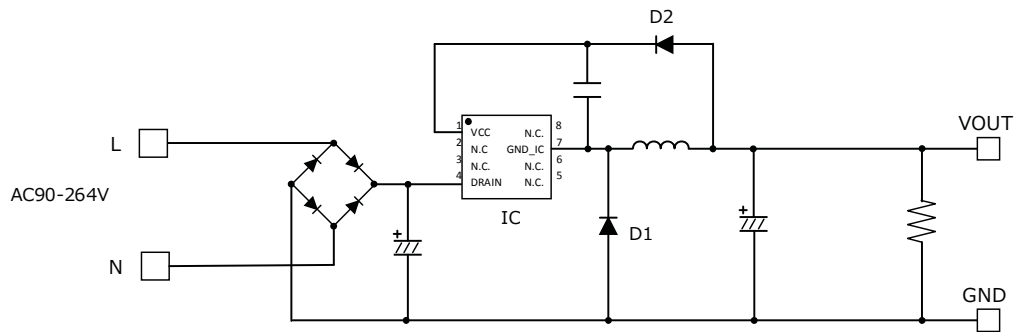

Figure 4. BM2P189TF-EVK-001 Application Circuit

The BM2P189TF is non-insulation method without opto-coupler and feeds back the VCC voltage to 18.0 V typ. This VCC voltage is the voltage between the VCC pin and the GND_IC pin.

The output voltage V_{OUT} is defined by the following equation.

$$V_{OUT} = V_{CNT} + V_{FD2} - V_{FD1}$$

V_{CNT} : VCC Control Voltage

V_{FD1} : Forward Voltage of diode D1

V_{FD2} : Forward Voltage of diode D2

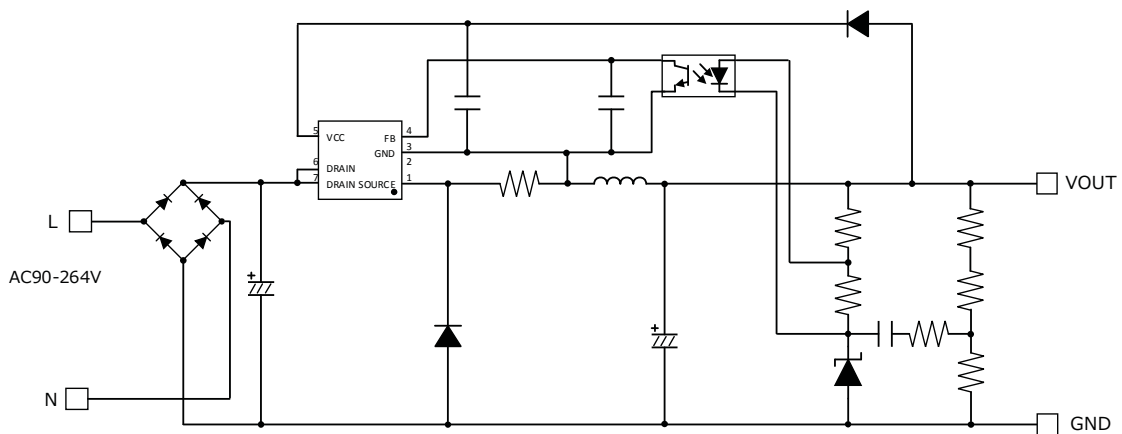

Figure 5. General Buck converter application circuit

Compared to the general Buck converter as shown above, the number of parts is reduced because the feedback circuit is not required. However, the output voltage may rise at light load because the VCC voltage and the output voltage that are fed back are different. In that case, please put a resistance on the output terminal and lower the output voltage.

BM2P189TF Overview

Feature

- PWM Frequency =100kHz
- PWM current mode method
- Frequency hopping function
- Burst operation at light load
- Built-in 650 start circuit
- Built-in 650V switching MOSFET
- VCC pin under voltage protection
- VCC pin over voltage protection
- Over current limiter function per cycle
- Soft start function

Key specifications

- Power Supply Voltage Operation Range:
 - VCC: 10.60 V to 19.45 V
 - DRAIN: to 650 V
- Normal Operation Current: 0.85 mA(Typ)
- Burst Operation Current: 0.45 mA(Typ)
- Oscillation Frequency: 100 kHz(Typ)
- Operation Temperature Range: -40 °C ~ +105 °C
- MOSFET Ron: 9.5 Ω (Typ.)

Application

LED lights, air conditioners, and cleaners, (etc.).

W(Typ) x D(Typ) x H(Typ)

SOP-J8 5.00 mm x 6.20 mm x 1.71 mm
Pitch 1.27 mm



Figure 6. SOP8 Package

(*) Product structure : Silicon monolithic integrated circuit This product has no designed protection against radioactive rays

(*) Operating the IC over the absolute maximum ratings may damage the IC. The damage can either be a short circuit between pins or an open circuit between pins and the internal circuitry. Therefore, it is important to consider circuit protection measures, such as adding a fuse, in case the IC is operated over the absolute maximum ratings.

Table 1. BM2P189TF Pin description

No.	Name	I/O	Function	ESD Diode	
				VCC	GND
1	VCC	I	Power Supply input pin	-	✓
2	-	-	-	-	-
3	-	-	-	-	-
4	DRAIN	I/O	MOSFET DRAIN pin	-	✓
5	-	-	-	-	-
6	-	-	-	-	-
7	GND_IC	I/O	GND pin	✓	-
8	-	-	-	-	-

Design Overview

1 Important Parameter

- V_{IN} : Input Voltage Range AC 90 V ~ 264 Vac (DC 100 V ~ 380 V)
- V_{OUT} : Output Voltage DC 18 V
- $I_{OUT(Typ)}$: Constant Output Current 0.167 A
- $I_{OUT(Max)}$: Max Output Current 0.167 A
- f_{SW} : Switching Frequency Min:94 kHz, Typ:100 kHz, Max:106 kHz
- $I_{peak(Min)}$: Over Current Limit Min:0.395 A, Typ:0.450 A, Max:0.505A

2 Coil Selection

2.1 Determining coil inductance

The switching operation mode determines the L value so that it becomes as discontinuous mode (DCM) as possible. In the continuous mode (CCM), reverse current in trr of the diode flows, which leads to an increase in power loss of diode. Furthermore, this reverse current becomes the peak current when the MOSFET is ON, and the power loss of the MOSFET also increases. The constant load current $I_{OUT(Typ)}$: 0.167 A, the peak current I_L flowing through the inductor is:

$$I_P(BCM) = I_{OUT(Typ)} \times 2 = 0.334 \quad [A]$$

It tends to be in continuous mode (CCM) when the input voltage drops. Calculate with input voltage minimum voltage 100 Vdc. From the output voltage V_{OUT} : 18 V and the diode V_F : 1 V, Calculate the maximum value of Duty: Duty (Max).

$$Duty(max) = \frac{V_{OUT} + V_F}{V_{IN}(Min)}$$

From the minimum switching frequency $f_{SW}(Min) = 94$ kHz, Calculate on time $t_{ON}(Max)$

$$t_{ON}(Max) = \frac{Duty(Max)}{f_{SW}(Min)} = 2.02 \quad [\mu sec]$$

Calculate L value to operate in discontinuous mode.

$$L < t_{ON}(Max) \times \frac{V_{IN}(Min) - V_{OUT}}{I_P} = 495.9 \quad [\mu H]$$

Then, the L value is provisionally selected to be 470 μH in consideration of generality.

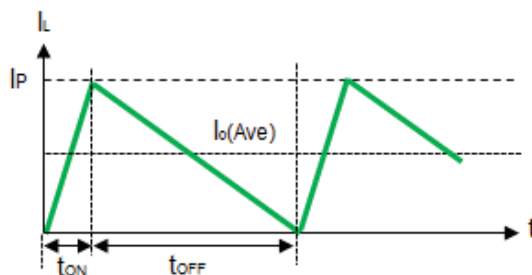

Figure 7. Coil current waveform in BCM

2.1 Determining coil inductance - Continued

Also, calculate L value so that the overcurrent detection becomes maximum load current I_{OUT}: 167 mA or more. Overcurrent detection is calculated by the current flowing through the MOSFET when operating in continuous mode at the minimum switching frequency f_{sw} (Min) = 94 kHz. When the current flowing through the MOSFET (≠ the coil current at switching ON) exceeds the minimum value I_{peak} (Min): 0.395 A of the overcurrent detection current, the MOSFET is turned OFF. Since a delay of approximately tdly = 0.1 μsec occurs, in reality, the peak current exceeds the I_{peak} value and the peak current becomes I_p. The peak current I_p is obtained by setting the current slope at switching ON to ΔI_L,

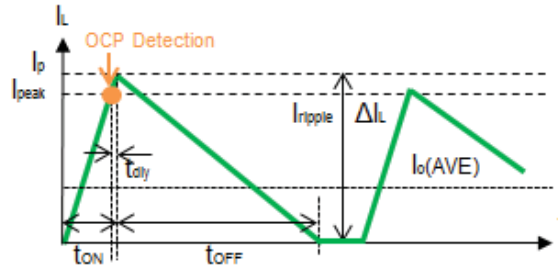

Figure 8. Coil waveform at overcurrent detection (DCM)

The peak current I_p at the time of over current detection is

$$I_p = I_{PEAK}(Min) + \Delta I_L \times tdly$$

$$I_p = I_{PEAK}(Min) + \frac{V_{IN}(Min) - V_{OUT}}{L} \times tdly = 412 \text{ [mA]}$$

Assuming the discontinuous mode (DCM), Switching ON time: t_{on}, OFF time: t_{off} are

$$t_{ON}(DCM) = \frac{I_p \times L}{V_{IN}(Min) - V_{OUT}} = 2.36 \text{ [}\mu\text{sec]}$$

$$t_{OFF}(DCM) = \frac{I_p \times L}{V_{OUT} + V_F} = 10.19 \text{ [}\mu\text{sec]}$$

$$t_{ON}(DCM) + t_{OFF}(DCM) = 12.55 \text{ [}\mu\text{sec]}$$

Since the total of ON time and OFF time is less than 10.64 μsec in switching cycle, it becomes continuous mode (CCM) when detecting over current. The current at the time of overcurrent detection in discontinuous mode (CCM): I_{OUT} (LIM) is

$$I_{OUT}(LIM) = I_p - \frac{(V_{OUT} + V_F) \times (V_{IN}(Min) - V_{OUT})}{2 \times V_{IN}(Min) \times f_{SW} \times L} = 246.3 \text{ [mA]}$$

It is confirmed that the minimum over current detection current is 246 mA and the maximum load current is 167 mA or more.

2 Coil Selection - Continued

2.2 Inductor Current Calculation

Calculate the maximum peak current of the inductor. The condition where the peak current is maximized is when the input voltage is the maximum voltage $V_{IN} (Max)$: 380 V, the maximum load current $I_O (Max)$: 0.167 A, and the switching frequency is 106 kHz at the minimum. The peak current I_P of the coil is given by the following formula.

$$I_P = \sqrt{\frac{2 \times I_O \times (V_{IN}(Max) - V_O) \times (V_O + V_F)}{F_{SW}(Max) \times L \times (V_{IN} + V_F)}} = 348 \text{ [mA]}$$

Select a coil with a rated current of 0.348 A or more.

In this EVK, we use inductance value: 470 μ H, rated: 0.5 A product

Radial inductor (closed magnetic circuit type) Core Size Φ 11.0 mm x 11.5 mm

Product: 744 747 147 1

Manufacture: Würth Electronix

3 Diode Selection

3.1 Flywheel Diode: D1

Flywheel diode uses fast diode (fast recovery diode). The reverse voltage of the diode is $V_{IN} (Max)$: 380 V when the output voltage at startup is 0 V. Consider the derating and select 600 V diode. The condition where the effective current of the diode is maximized is when the input voltage is the maximum voltage $V_{IN} (Max)$: 380 V, the maximum load current $I_O (Max)$: 0.167 A, and the switching frequency is 94 kHz at the minimum.

$$Duty = \frac{V_{OUT} + V_F}{V_{IN}(Max)} = 5.0 \quad [\%]$$

The average current I_D of the diode is calculated from the peak current I_P : 0.348 A by the following formula

$$I_D(rms) = I_P \times \sqrt{\frac{1 - Duty}{3}} = 0.196 \quad [A]$$

Select the rated current of 0.196 A or more.

In fact, we used RFN1LAM6S of 0.8 A / 600 V product as a result of mounting the board and considering the parts temperature.

3.2 VCC Rectifier Diode: D2

Rectifier diodes are used for diodes to supply VCC. The reverse voltage applied to the diode is $V_{IN} (Max)$: 380 V. Consider the derating and select 600 V diode. Since the current flowing to the IC is small enough, we use the 0.2 A / 600 V RRE02VSM6S.

Design Overview – Continued

4 Capacitor Selection

4.1 Input Capacitor: C1

The input capacitor is determined by input voltage V_I and output power P_{OUT} . As a guide, for an input voltage of 90 to 264 Vac, $2 \times P_{OUT}$ [W] μ F. For 176 to 264 Vac, set $1 \times P_{OUT}$ [W] μ F. Since the output power $P_{OUT} = 2$ W, 4.7μ F / 400 V is selected with a guideline of 6.0μ F.

4.2 VCC Capacitor: C3

The VCC capacitor C3 is required for stable operation of the device and stable feedback of the output voltage. A withstand voltage of 25 V or more is required, and 1.0μ F to 4.7μ F is recommended. 1μ F / 50 V is selected.

4.3 Output Capacitor: C2, C4

For the output capacitor, select output voltage V_O of 25 V or more in consideration of derating. For C2 electrolytic capacitors, capacitance, impedance and rated ripple current must be taken into consideration.

The output ripple voltage is a composite waveform generated by electrostatic capacity: C_{OUT} , impedance: ESR when the ripple component of inductor current: ΔI_L flows into the output capacitor and is expressed by the following formula.

$$\Delta V_{ripple} = \Delta I_L \times \left(\frac{1}{8 \times C_{out} \times f_{sw}} \right) + ESR$$

The inductor ripple current is

$$\Delta I_L = 2 \times \{I_P - I_{OUT}(max)\} = 2 \times (0.348 - 0.167) = 0.361 \quad [A]$$

For this EVK, we use electrostatic capacity: 100μ F, ESR: 0.075Ω , and the design value of output ripple voltage is less than 100 mV.

$$\Delta V_{ripple} = \Delta I_L \times \left\{ \left(\frac{1}{8 \times C_{out} \times f_{sw}} \right) + ESR \right\} = 0.361 \times \left\{ \left(\frac{1}{8 \times 100 \mu \times 100k} \right) + 0.075 \right\} = 31.6 \quad [mV]$$

Next, check whether the ripple current of the capacitor satisfies the rated ripple current.

Inductor ripple current RMS conversion,

$$I_L[rms] = \Delta I_L \times \sqrt{\frac{1}{3}} = 0.208 \quad [A]$$

The ripple current of the capacitor is

$$I_C[rms] = \sqrt{I_L^2 - I_{OUT}^2} = \sqrt{0.208^2 - 0.167^2} = 0.124 \quad [A]$$

4.3 Output Capacitor C2, C4 - Continued

Select a rated current of 0.124 A or more.

The output capacitor C2 used a rated ripple current of 0.73 A at 100 μ F / 50 V.

C8 has added a 0.1 μ F ceramic capacitor to reduce switching noise.

5. Resistor Selection

5.1 Bleeder Resistor: R1

Because it is indirectly fed back to the output voltage, the output voltage increases at light load. This board uses bleeder resistance for its improvement. Reducing the resistance value improves the rise in the output voltage of the light load, but increases the power loss. 10 k Ω / 0.1 W is used.

Performance Data

Constant Load Regulation

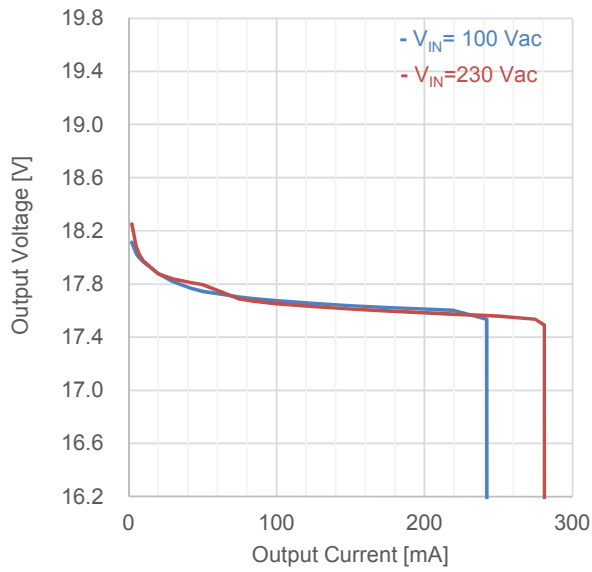

Figure 9. Load Regulation (I_{OUT} vs V_{OUT})

Table 2. Load Regulation ($V_{IN}=100$ Vac)

I_{OUT}	V_{OUT}	Efficiency
42 mA	17.768 V	79.05 %
84 mA	17.691 V	83.02 %
125 mA	17.653 V	84.22 %
167 mA	17.628 V	84.72 %

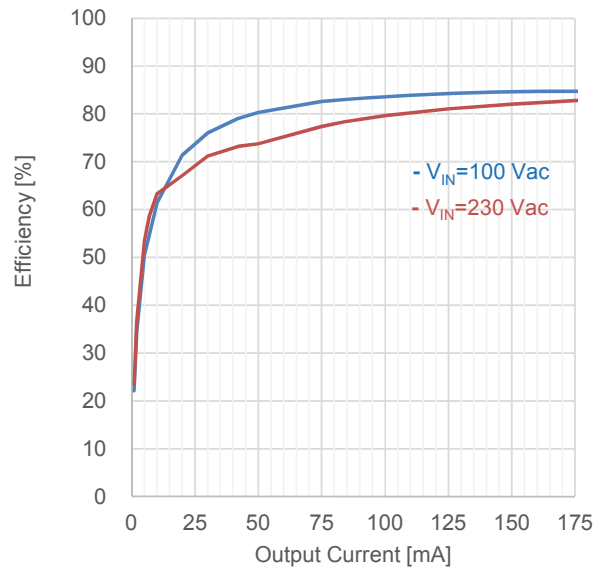

Figure 10. Load Regulation (I_{OUT} vs Efficiency)

Table 3. Load Regulation ($V_{IN}=230$ Vac)

I_{OUT}	V_{OUT}	Efficiency
42 mA	17.810 V	73.19 %
84 mA	17.672 V	78.38 %
125 mA	17.629 V	81.08 %
167 mA	17.601 V	82.54 %

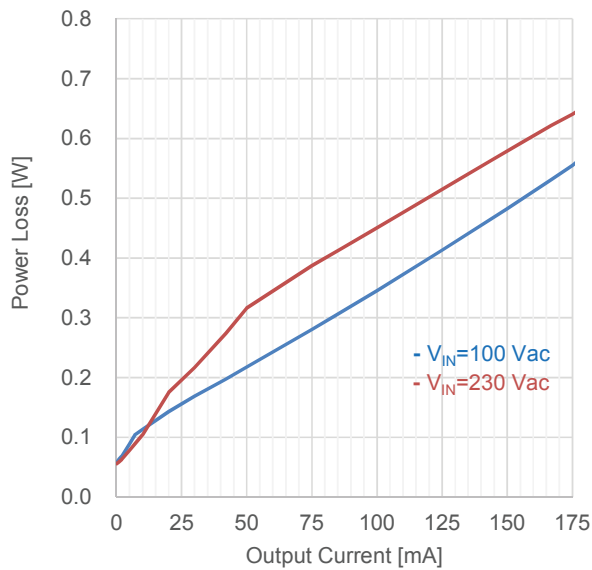

Figure 11. Load Regulation (I_{OUT} vs P_{LOSS})

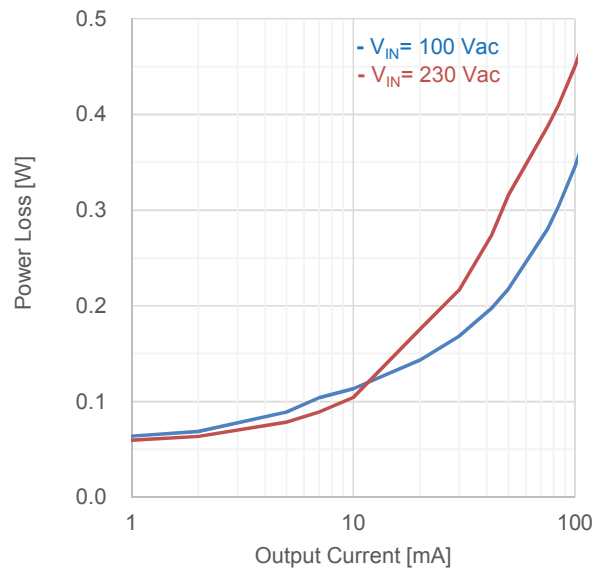

Figure 12. Load Regulation (I_{OUT} vs P_{LOSS})

Performance Data - Continued

Table 4. Load Regulation : VIN=100 Vac

V _{IN} [Vac]	P _{IN} [W]	V _{OUT} [V]	I _{OUT} [mA]	P _{OUT} [W]	P _{LOSS} [W]	Efficiency [%]
100	0.058	18.249	0	0.000	0.058	0.00
100	0.082	18.164	1	0.018	0.064	22.15
100	0.105	18.115	2	0.036	0.069	34.50
100	0.179	18.028	5	0.090	0.089	50.36
100	0.230	17.997	7	0.126	0.104	54.77
100	0.293	17.964	10	0.180	0.113	61.31
100	0.501	17.879	20	0.358	0.143	71.37
100	0.703	17.817	30	0.535	0.168	76.03
100	0.944	17.768	42	0.746	0.198	79.05
100	1.105	17.745	50	0.887	0.218	80.29
100	1.608	17.702	75	1.328	0.280	82.57
100	1.790	17.691	84	1.486	0.304	83.02
100	2.113	17.673	100	1.767	0.346	83.64
100	2.620	17.653	125	2.207	0.413	84.22
100	3.128	17.637	150	2.646	0.482	84.58
100	3.475	17.628	167	2.944	0.531	84.72
100	3.639	17.623	175	3.084	0.555	84.75
100	4.166	17.611	200	3.522	0.644	84.55
100	4.599	17.601	220	3.872	0.727	84.20
100	5.062	17.534	242	4.243	0.819	83.83
100	0.900	0.723	243	0.176	0.724	19.52

Table 5. Load Regulation: VIN=230 Vac

V _{IN} [Vac]	P _{IN} [W]	V _{OUT} [V]	I _{OUT} [mA]	P _{OUT} [W]	P _{LOSS} [W]	Efficiency [%]
230	0.056	18.576	0	0.000	0.056	0.00
230	0.078	18.367	1	0.018	0.060	23.55
230	0.100	18.252	2	0.037	0.063	36.50
230	0.169	18.081	5	0.090	0.079	53.49
230	0.215	18.025	7	0.126	0.089	58.69
230	0.284	17.972	10	0.180	0.104	63.28
230	0.533	17.877	20	0.358	0.175	67.08
230	0.752	17.840	30	0.535	0.217	71.17
230	1.022	17.810	42	0.748	0.274	73.19
230	1.206	17.796	50	0.890	0.316	73.78
230	1.714	17.688	75	1.327	0.387	77.40
230	1.894	17.672	84	1.484	0.410	78.38
230	2.216	17.651	100	1.765	0.451	79.65
230	2.718	17.629	125	2.204	0.514	81.08
230	3.221	17.612	150	2.642	0.579	82.02
230	3.561	17.601	167	2.939	0.622	82.54
230	3.720	17.597	175	3.079	0.641	82.78
230	4.227	17.584	200	3.517	0.710	83.20
230	4.677	17.573	220	3.866	0.811	82.66
230	5.380	17.559	250	4.390	0.990	81.59
230	5.974	17.535	275	4.822	1.152	80.72
230	6.094	17.490	281	4.915	1.179	80.65
230	0.130	0.000	282	0.000	0.130	0.00

Performance Data - Continued

Line Regulation

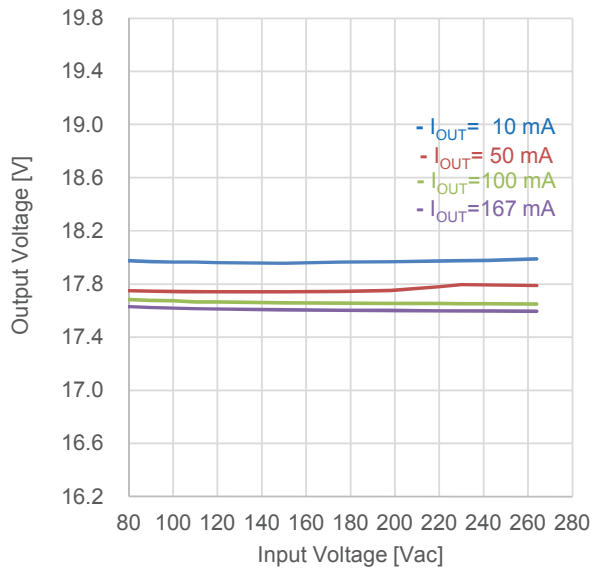

Figure 13. Line Regulation (V_{IN} vs V_{OUT})

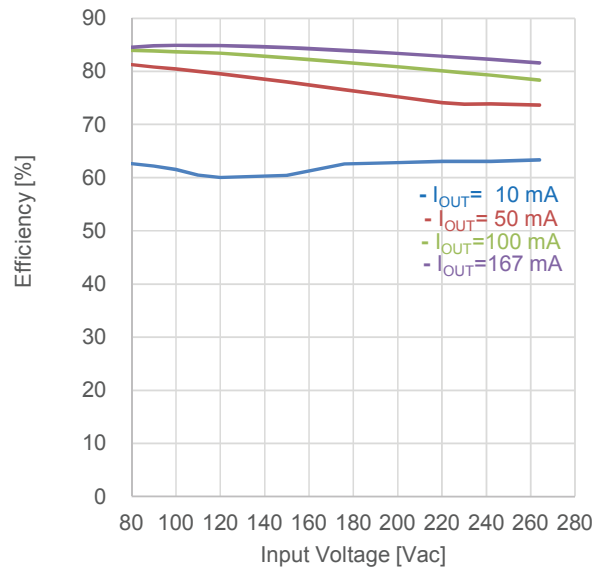

Figure 14. Line Regulation (V_{IN} vs Efficiency)

Switching Frequency

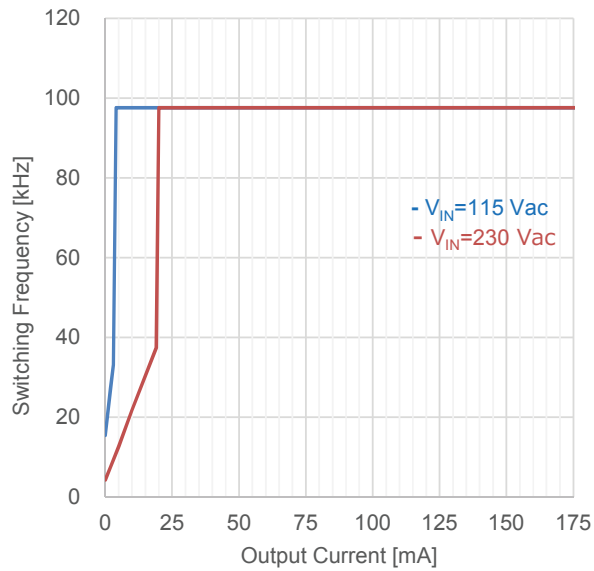

Figure 15. Switching Frequency (I_{OUT} vs f_{sw})

Coil Peak Current

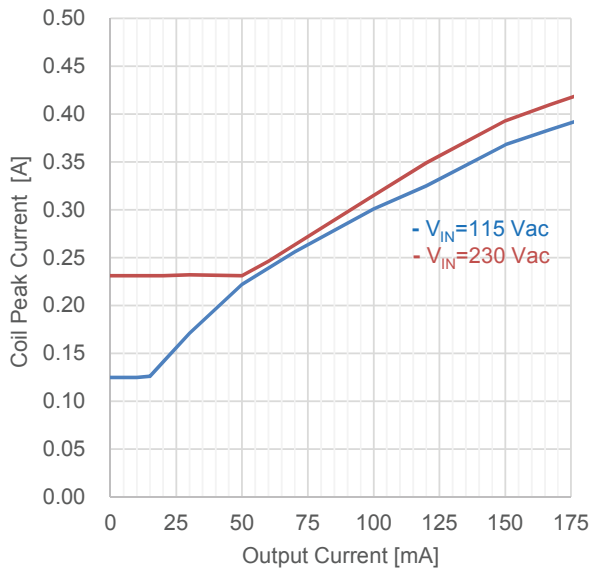

Figure 16. Coil Peak Current (I_{OUT} vs I_P)

Performance Data - Continued

Output Ripple Voltage

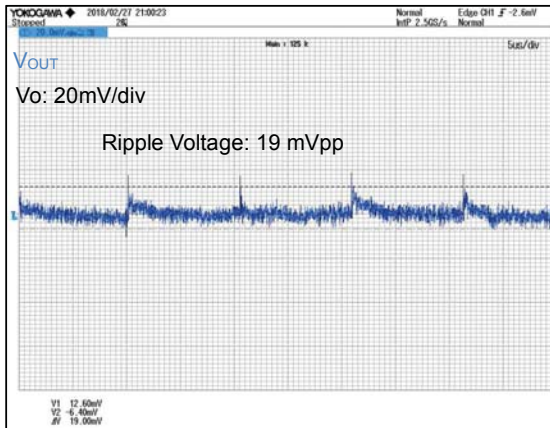

Figure 17. $V_{IN} = 115 \text{ Vac}$, $I_{OUT} = 10 \text{ mA}$

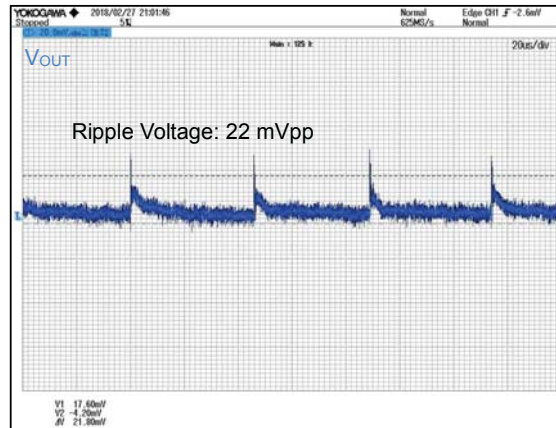

Figure 18. $V_{IN} = 230 \text{ Vac}$, $I_{OUT} = 10 \text{ mA}$

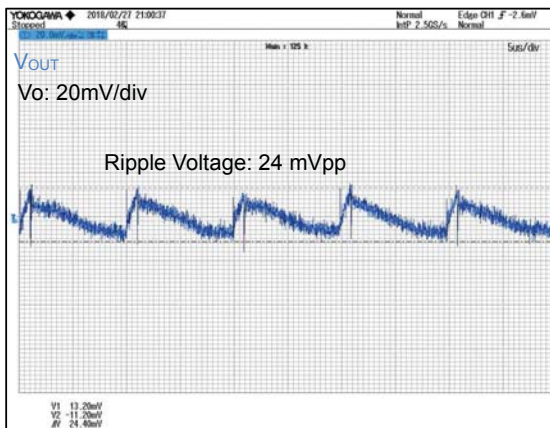

Figure 19. $V_{IN} = 115 \text{ Vac}$, $I_{OUT} = 0.100 \text{ A}$

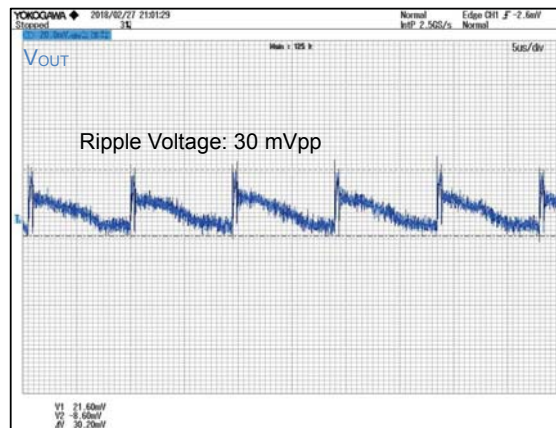

Figure 20. $V_{IN} = 230 \text{ Vac}$, $I_{OUT} = 0.100 \text{ A}$

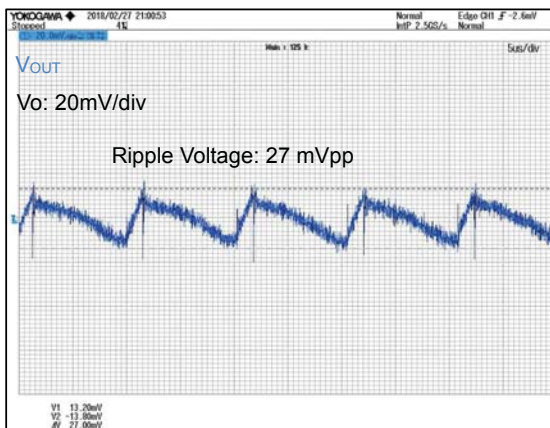

Figure 21. $V_{IN} = 115 \text{ Vac}$, $I_{OUT} = 0.167 \text{ A}$

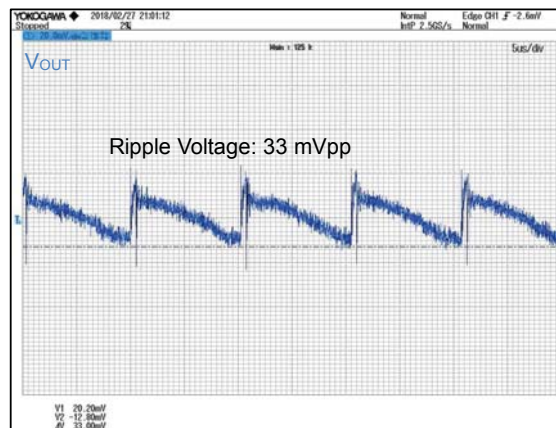

Figure 22. $V_{IN} = 230 \text{ Vac}$, $I_{OUT} = 0.167 \text{ A}$

Performance Data – Continued

Parts surface temperature

Table 6. Parts surface temperature ※Ta = 25 °C, measured 30 minutes after setup

Part	Condition	
	V _{IN} =90 Vac, I _{OUT} =0.167 A	V _{IN} =264 Vac, I _{OUT} =0.167 A
IC1	55.3 °C	64.1 °C
D1	53.3 °C	60.7 °C
L1	55.7 °C	68.4 °C

Schematics

V_{IN} = 90 ~ 264 Vac, V_{OUT} = 10 V

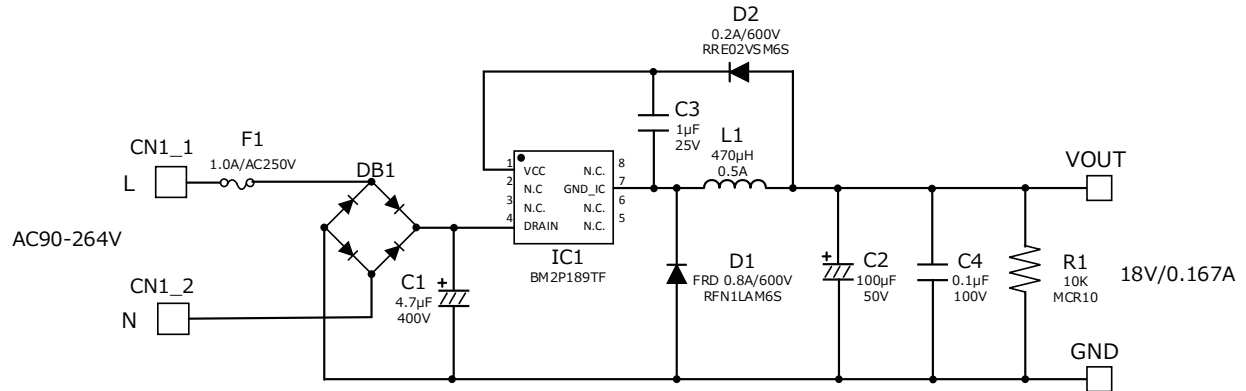

Figure 23. BM2P189TF-EVK-001 Schematics

Bill of Materials

Table 7. BoM of BM2P189TF-EVK-001

Part Reference	Qty.	Type	Value	Description	Part Number	Manufacture	Configuration mm (inch)
C1	1	Electrolytic	4.7 µF	400 V, ±20%	860 021 374 008	Wurth	-
C2	1	Electrolytic	100 µF	50 V, ±20%	860 080 674 009	Wurth	-
C3	1	Ceramic	1 µF	25 V, X7R, ±20%	TMK107B7105MA-T	Taiyo Yuden	1608 (0603)
C4	1	Ceramic	0.1 µF	100 V, X7R, ±20%	HMK107B7104MA-T	Taiyo Yuden	1608 (0603)
CN1	1	Connector	-	2pin	B2P-VH	JST	-
D1	1	FRD	0.8 A	600 V	RFN1LAM6S	ROHM	PMDS
D2	1	Diode	0.2 A	600 V	RRE02VSM6S	ROHM	TUMD2SM
DB1	1	Bridge	1 A	800 V	D1UBA80-7062	Shindengen	SOPA-4
F1	1	Fuse	1 A	250 V	39211000000	Littelfuse	-
IC1	1	AC/DC Converter	-	-	BM2P189TF	ROHM	SOP8
L1	1	Coil	470 µH	0.5 A	744 747 147 1	Wurth	-
R1	1	Resistor	10k Ω	0.1 W, ±5%	MCR10EZPJ103	ROHM	2012 (0805)

Layout

Size: 18 mm x 40 mm

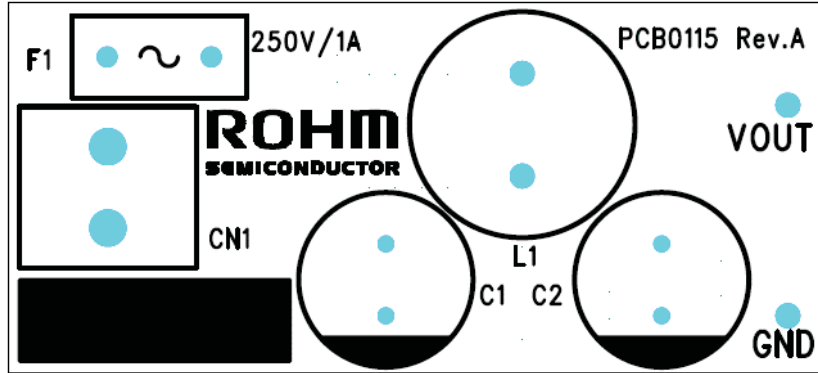

Figure 24. TOP Silkscreen (Top view)

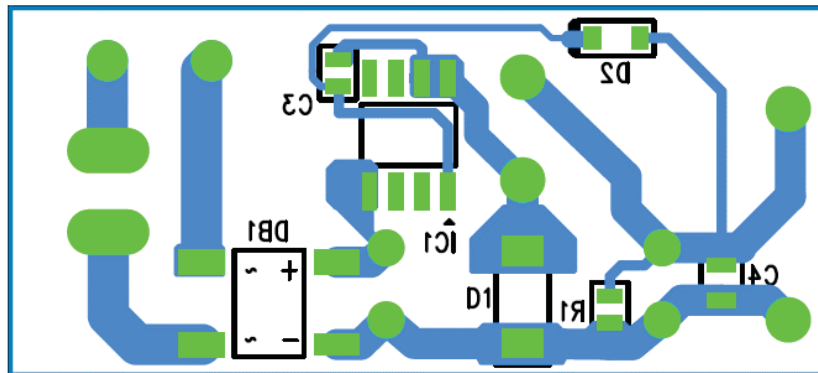

Figure 25. Bottom Layout (TOP View)

Notes

- 1) The information contained herein is subject to change without notice.
- 2) Before you use our Products, please contact our sales representative and verify the latest specifications :
- 3) Although ROHM is continuously working to improve product reliability and quality, semiconductors can break down and malfunction due to various factors.
Therefore, in order to prevent personal injury or fire arising from failure, please take safety measures such as complying with the derating characteristics, implementing redundant and fire prevention designs, and utilizing backups and fail-safe procedures. ROHM shall have no responsibility for any damages arising out of the use of our Products beyond the rating specified by ROHM.
- 4) Examples of application circuits, circuit constants and any other information contained herein are provided only to illustrate the standard usage and operations of the Products. The peripheral conditions must be taken into account when designing circuits for mass production.
- 5) The technical information specified herein is intended only to show the typical functions of and examples of application circuits for the Products. ROHM does not grant you, explicitly or implicitly, any license to use or exercise intellectual property or other rights held by ROHM or any other parties. ROHM shall have no responsibility whatsoever for any dispute arising out of the use of such technical information.
- 6) The Products specified in this document are not designed to be radiation tolerant.
- 7) For use of our Products in applications requiring a high degree of reliability (as exemplified below), please contact and consult with a ROHM representative : transportation equipment (i.e. cars, ships, trains), primary communication equipment, traffic lights, fire/crime prevention, safety equipment, medical systems, servers, solar cells, and power transmission systems.
- 8) Do not use our Products in applications requiring extremely high reliability, such as aerospace equipment, nuclear power control systems, and submarine repeaters.
- 9) ROHM shall have no responsibility for any damages or injury arising from non-compliance with the recommended usage conditions and specifications contained herein.
- 10) ROHM has used reasonable care to ensure the accuracy of the information contained in this document. However, ROHM does not warrants that such information is error-free, and ROHM shall have no responsibility for any damages arising from any inaccuracy or misprint of such information.
- 11) Please use the Products in accordance with any applicable environmental laws and regulations, such as the RoHS Directive. For more details, including RoHS compatibility, please contact a ROHM sales office. ROHM shall have no responsibility for any damages or losses resulting non-compliance with any applicable laws or regulations.
- 12) When providing our Products and technologies contained in this document to other countries, you must abide by the procedures and provisions stipulated in all applicable export laws and regulations, including without limitation the US Export Administration Regulations and the Foreign Exchange and Foreign Trade Act.
- 13) This document, in part or in whole, may not be reprinted or reproduced without prior consent of ROHM.



Thank you for your accessing to ROHM product informations.
More detail product informations and catalogs are available, please contact us.

ROHM Customer Support System

<http://www.rohm.com/contact/>

Mouser Electronics

Authorized Distributor

Click to View Pricing, Inventory, Delivery & Lifecycle Information:

[ROHM Semiconductor:](#)

[BM2P189TF-EVK-001](#)