

FEATURES

- Low noise: 2.7 nV/ $\sqrt{\text{Hz}}$ at $f = 10$ kHz
- Low offset voltage: 250 μV max over V_{CM}
- Offset voltage drift: 0.4 $\mu\text{V}/^\circ\text{C}$ typ and 2.3 $\mu\text{V}/^\circ\text{C}$ max
- Bandwidth: 28 MHz
- Rail-to-rail input/output
- Unity gain stable
- 2.7 V to 5.5 V operation
- -40°C to $+125^\circ\text{C}$ operation
- Qualified for automotive applications

APPLICATIONS

- ADC and DAC buffers
- Audio
- Industrial controls
- Precision filters
- Digital scales
- Automotive collision avoidance
- PLL filters

GENERAL DESCRIPTION

The [AD8655/AD8656](#) are the industry's lowest noise, precision CMOS amplifiers. They leverage the Analog Devices DigiTrim® technology to achieve high dc accuracy.

The [AD8655/AD8656](#) provide low noise (2.7 nV/ $\sqrt{\text{Hz}}$ at 10 kHz), low THD + N (0.0007%), and high precision performance (250 μV max over V_{CM}) to low voltage applications. The ability to swing rail-to-rail at the input and output enables designers to buffer analog-to-digital converters (ADCs) and other wide dynamic range devices in single-supply systems.

PIN CONFIGURATIONS

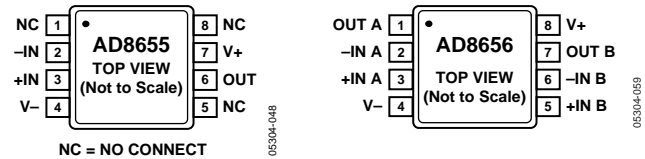

Figure 1. [AD8655](#)
8-Lead MSOP (RM-8)
8-Lead SOIC (R-8)

Figure 2. [AD8656](#)
8-Lead MSOP (RM-8)
8-Lead SOIC (R-8)

The high precision performance of the [AD8655/AD8656](#) improves the resolution and dynamic range in low voltage applications. Audio applications, such as microphone pre-amps and audio mixing consoles, benefit from the low noise, low distortion, and high output current capability of the [AD8655/AD8656](#) to reduce system level noise performance and maintain audio fidelity. The high precision and rail-to-rail input and output of the [AD8655/AD8656](#) benefit data acquisition, process controls, and PLL filter applications.

The [AD8655/AD8656](#) are fully specified over the -40°C to $+125^\circ\text{C}$ temperature range. The [AD8655/AD8656](#) are available in Pb-free, 8-lead MSOP and SOIC packages. The [AD8655/AD8656](#) are both available for automotive applications.

TABLE OF CONTENTS

Features	1
Applications	1
Pin Configurations	1
General Description	1
Revision History	2
Specifications	3
Absolute Maximum Ratings	5
ESD Caution	5
Typical Performance Characteristics	6
Theory of Operation	15
Applications Information	16

Input Overvoltage Protection	16
Input Capacitance	16
Driving Capacitive Loads	16
Layout, Grounding, and Bypassing Considerations	18
Power Supply Bypassing	18
Grounding	18
Leakage Currents	18
Outline Dimensions	19
Ordering Guide	19
Automotive Products	19

REVISION HISTORY

10/13—Rev. D to Rev. E

Changes to Figure 1 Caption and Figure 2 Caption	1
Deleted Figure 3 and Figure 4; Renumbered Sequentially	1
Change to General Description Section	1
Change to Figure 4	6
Change to Figure 32	10
Changes to Ordering Guide	19
Changes to Automotive Products Section	19

6/13—Rev. C to Rev. D

Change to Figure 57	16
---------------------------	----

5/13—Rev. B to Rev. C

Change to Figure 57	16
---------------------------	----

9/11—Rev. A to Rev. B

Changes to Features Section	1
Updated Outline Dimensions	19
Changes to Ordering Guide	19
Added Automotive Products Section	19

6/05—Rev. 0 to Rev. A

Added AD8656	Universal
Added Figure 2 and Figure 4	1
Changes to Specifications	3
Changed Caption of Figure 12 and Added Figure 13	7
Replaced Figure 16	7
Changed Caption of Figure 37 and Added Figure 38	11
Replaced Figure 47	13
Added Figure 55	14
Changes to Ordering Guide	18

4/05—Revision 0: Initial Version

SPECIFICATIONS

$V_S = 5.0\text{ V}$, $V_{CM} = V_S/2$, $T_A = 25^\circ\text{C}$, unless otherwise specified.

Table 1.

Parameter	Symbol	Conditions	Min	Typ	Max	Unit
INPUT CHARACTERISTICS						
Offset Voltage	V_{OS}	$V_{CM} = 0\text{ V to }5\text{ V}$ $-40^\circ\text{C} \leq T_A \leq +125^\circ\text{C}$		50	250	μV
Offset Voltage Drift	$\Delta V_{OS}/\Delta T$	$-40^\circ\text{C} \leq T_A \leq +125^\circ\text{C}$		0.4	2.3	$\mu\text{V}/^\circ\text{C}$
Input Bias Current	I_B	$-40^\circ\text{C} \leq T_A \leq +125^\circ\text{C}$		1	10	pA
Input Offset Current	I_{OS}	$-40^\circ\text{C} \leq T_A \leq +125^\circ\text{C}$			500	pA
Input Voltage Range		$-40^\circ\text{C} \leq T_A \leq +125^\circ\text{C}$	0		5	V
Common-Mode Rejection Ratio	CMRR	$V_{CM} = 0\text{ V to }5\text{ V}$	85	100		dB
Large Signal Voltage Gain	A_{VO}	$V_O = 0.2\text{ V to }4.8\text{ V}$, $R_L = 10\text{ k}\Omega$, $V_{CM} = 0\text{ V}$ $-40^\circ\text{C} \leq T_A \leq +125^\circ\text{C}$	100	110		dB
			95			dB
OUTPUT CHARACTERISTICS						
Output Voltage High	V_{OH}	$I_L = 1\text{ mA}$; $-40^\circ\text{C} \leq T_A \leq +125^\circ\text{C}$	4.97	4.991		V
Output Voltage Low	V_{OL}	$I_L = 1\text{ mA}$; $-40^\circ\text{C} \leq T_A \leq +125^\circ\text{C}$		8	30	mV
Output Current	I_{OUT}	$V_{OUT} = \pm 0.5\text{ V}$		± 220		mA
POWER SUPPLY						
Power Supply Rejection Ratio	PSRR	$V_S = 2.7\text{ V to }5.0\text{ V}$	88	105		dB
Supply Current/Amplifier	I_{SY}	$V_O = 0\text{ V}$ $-40^\circ\text{C} \leq T_A \leq +125^\circ\text{C}$		3.7	4.5	mA
					5.3	mA
INPUT CAPACITANCE						
Differential	C_{IN}			9.3		pF
Common-Mode				16.7		pF
NOISE PERFORMANCE						
Input Voltage Noise Density	e_n	$f = 1\text{ kHz}$ $f = 10\text{ kHz}$		4		$\text{nV}/\sqrt{\text{Hz}}$
				2.7		$\text{nV}/\sqrt{\text{Hz}}$
Total Harmonic Distortion + Noise	THD + N	$G = 1$, $R_L = 1\text{ k}\Omega$, $f = 1\text{ kHz}$, $V_{IN} = 2\text{ V p-p}$		0.0007		$\%$
FREQUENCY RESPONSE						
Gain Bandwidth Product	GBP			28		MHz
Slew Rate	SR	$R_L = 10\text{ k}\Omega$		11		$\text{V}/\mu\text{s}$
Settling Time	t_s	To 0.1%, $V_{IN} = 0\text{ V to }2\text{ V step}$, $G = +1$		370		ns
Phase Margin		$C_L = 0\text{ pF}$		69		degrees

$V_S = 2.7\text{ V}$, $V_{CM} = V_S/2$, $T_A = 25^\circ\text{C}$, unless otherwise specified.

Table 2.

Parameter	Symbol	Conditions	Min	Typ	Max	Unit
INPUT CHARACTERISTICS						
Offset Voltage	V_{OS}	$V_{CM} = 0\text{ V to } 2.7\text{ V}$ $-40^\circ\text{C} \leq T_A \leq +125^\circ\text{C}$		44	250	μV
Offset Voltage Drift	$\Delta V_{OS}/\Delta T$	$-40^\circ\text{C} \leq T_A \leq +125^\circ\text{C}$		0.4	550	$\mu\text{V}/^\circ\text{C}$
Input Bias Current	I_B	$-40^\circ\text{C} \leq T_A \leq +125^\circ\text{C}$		1	10	μA
Input Offset Current	I_{OS}	$-40^\circ\text{C} \leq T_A \leq +125^\circ\text{C}$			500	μA
Input Voltage Range		$-40^\circ\text{C} \leq T_A \leq +125^\circ\text{C}$	0		10	μA
Common-Mode Rejection Ratio	CMRR	$V_{CM} = 0\text{ V to } 2.7\text{ V}$	80	98	500	μA
Large Signal Voltage Gain	A_{VO}	$V_O = 0.2\text{ V to } 2.5\text{ V}$, $R_L = 10\text{ k}\Omega$, $V_{CM} = 0\text{ V}$ $-40^\circ\text{C} \leq T_A \leq +125^\circ\text{C}$	98		2.7	V
			90			dB
OUTPUT CHARACTERISTICS						
Output Voltage High	V_{OH}	$I_L = 1\text{ mA}$; $-40^\circ\text{C} \leq T_A \leq +125^\circ\text{C}$	2.67	2.688		V
Output Voltage Low	V_{OL}	$I_L = 1\text{ mA}$; $-40^\circ\text{C} \leq T_A \leq +125^\circ\text{C}$		10	30	mV
Output Current	I_{OUT}	$V_{OUT} = \pm 0.5\text{ V}$		± 75		mA
POWER SUPPLY						
Power Supply Rejection Ratio	PSRR	$V_S = 2.7\text{ V to } 5.0\text{ V}$	88	105		dB
Supply Current/Amplifier	I_{SY}	$V_O = 0\text{ V}$ $-40^\circ\text{C} \leq T_A \leq +125^\circ\text{C}$		3.7	4.5	mA
					5.3	mA
INPUT CAPACITANCE						
Differential	C_{IN}			9.3		pF
Common-Mode				16.7		pF
NOISE PERFORMANCE						
Input Voltage Noise Density	e_n	$f = 1\text{ kHz}$ $f = 10\text{ kHz}$		4.0		$\text{nV}/\sqrt{\text{Hz}}$
Total Harmonic Distortion + Noise	THD + N	$G = 1$, $R_L = 1\text{ k}\Omega$, $f = 1\text{ kHz}$, $V_{IN} = 2\text{ V p-p}$		0.0007		$\%$
FREQUENCY RESPONSE						
Gain Bandwidth Product	GBP			27		MHz
Slew Rate	SR	$R_L = 10\text{ k}\Omega$		8.5		$\text{V}/\mu\text{s}$
Settling Time	t_s	To 0.1%, $V_{IN} = 0\text{ to } 1\text{ V step}$, $G = +1$		370		ns
Phase Margin		$C_L = 0\text{ pF}$		54		degrees

ABSOLUTE MAXIMUM RATINGS

Table 3.

Parameter	Rating
Supply Voltage	6 V
Input Voltage	VSS – 0.3 V to VDD + 0.3 V
Differential Input Voltage	±6 V
Output Short-Circuit Duration to GND	Indefinite
Electrostatic Discharge (HBM)	3.0 kV
Storage Temperature Range R, RM Packages	–65°C to +150°C
Junction Temperature Range R, RM Packages	–65°C to +150°C
Lead Temperature (Soldering, 10 sec)	260°C

Stresses above those listed under Absolute Maximum Ratings may cause permanent damage to the device. This is a stress rating only; functional operation of the device at these or any other conditions above those indicated in the operational section of this specification is not implied. Exposure to absolute maximum rating conditions for extended periods may affect device reliability.

Table 4.

Package Type	θ_{JA} ¹	θ_{JC}	Unit
8-Lead MSOP (RM)	210	45	°C/W
8-Lead SOIC (R)	158	43	°C/W

¹ θ_{JA} is specified for worst-case conditions; that is, θ_{JA} is specified for a device soldered in the circuit board for surface-mount packages.

ESD CAUTION



ESD (electrostatic discharge) sensitive device. Charged devices and circuit boards can discharge without detection. Although this product features patented or proprietary protection circuitry, damage may occur on devices subjected to high energy ESD. Therefore, proper ESD precautions should be taken to avoid performance degradation or loss of functionality.

TYPICAL PERFORMANCE CHARACTERISTICS



Figure 3. Input Offset Voltage Distribution



Figure 6. Input Offset Voltage vs. Common-Mode Voltage



Figure 4. Input Offset Voltage vs. Temperature



Figure 7. Input Bias Current vs. Temperature



Figure 5. $|TCV_{OS}|$ Distribution



Figure 8. Supply Current vs. Supply Voltage



Figure 9. Supply Current vs. Temperature



Figure 12. Output Voltage Swing High vs. Temperature



Figure 10. AD8655 Output Voltage to Supply Rail vs. Current Load



Figure 13. Output Voltage Swing Low vs. Temperature



Figure 11. AD8656 Output Swing vs. Current Load



Figure 14. CMRR vs. Frequency



Figure 15. Large Signal CMRR vs. Temperature



Figure 18. Voltage Noise Density vs. Frequency



Figure 16. Small Signal PSSR vs. Frequency



Figure 19. Low Frequency Noise (0.1 Hz to 10 Hz).



Figure 17. Large Signal PSSR vs. Temperature



Figure 20. No Phase Reversal



Figure 21. Open-Loop Gain and Phase vs. Frequency



Figure 24. Maximum Output Swing vs. Frequency



Figure 22. Large Signal Open-Loop Gain vs. Temperature

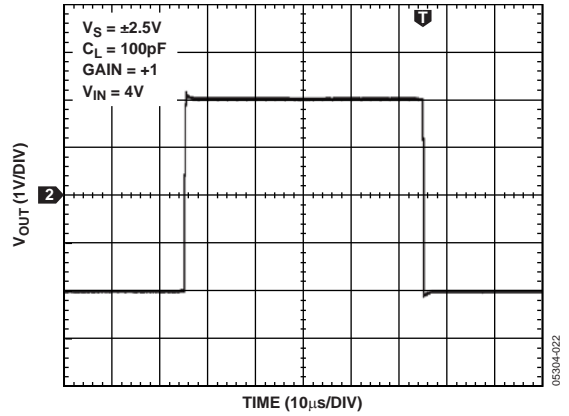

Figure 25. Large Signal Response



Figure 23. Closed-Loop Gain vs. Frequency

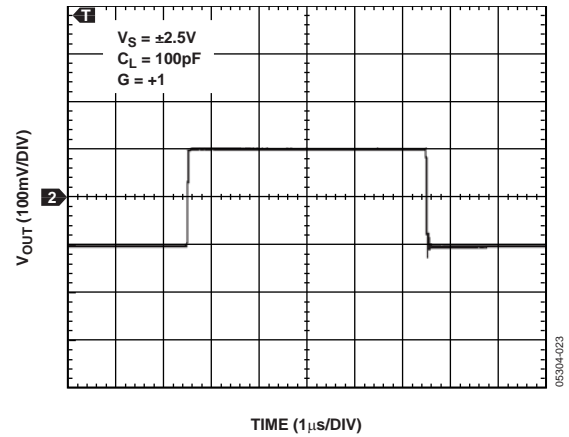

Figure 26. Small Signal Response



Figure 27. Small Signal Overshoot vs. Load Capacitance



Figure 30. Output Impedance vs. Frequency



Figure 28. Negative Overload Recovery Time



Figure 31. Input Offset Voltage Distribution



Figure 29. Positive Overload Recovery Time

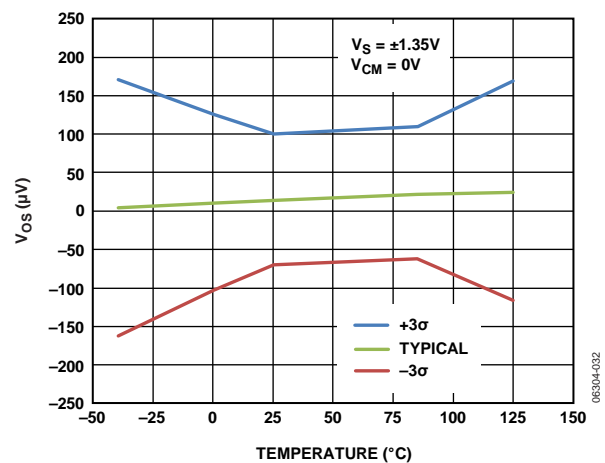

Figure 32. Input Offset Voltage vs. Temperature



Figure 33. |TCVOS| Distribution

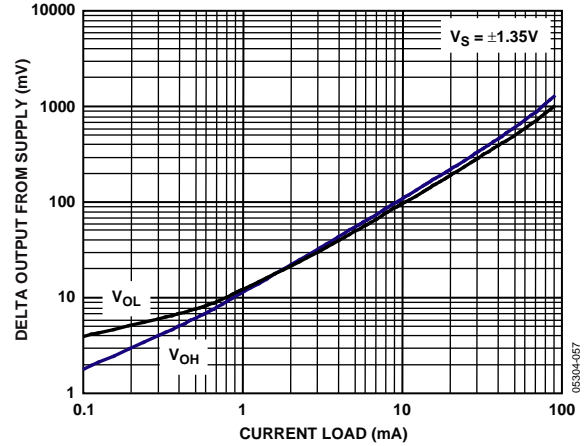

Figure 36. AD8656 Output Swing vs. Current Load



Figure 34. Supply Current vs. Temperature

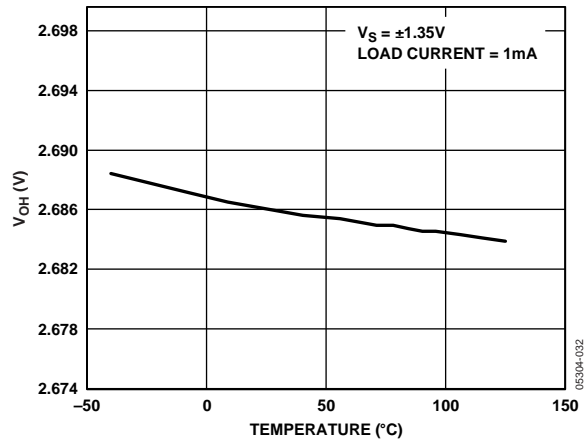

Figure 37. Output Voltage Swing High vs. Temperature



Figure 35. AD8655 Output Voltage to Supply Rail vs. Load Current

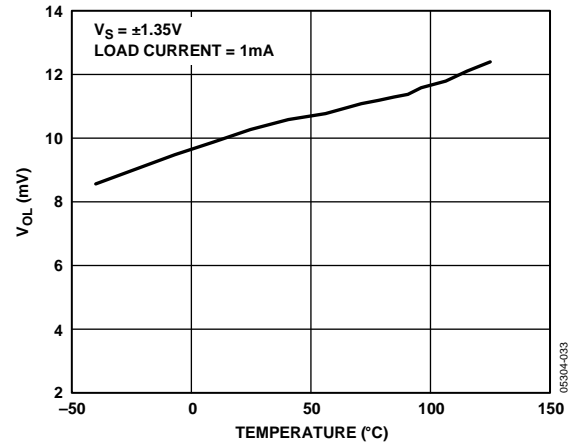

Figure 38. Output Voltage Swing Low vs. Temperature



Figure 39. No Phase Reversal



Figure 42. Small Signal Overshoot vs. Load Capacitance



Figure 40. Large Signal Response



Figure 43. Negative Overload Recovery Time



Figure 41. Small Signal Response



Figure 44. Positive Overload Recovery Time



Figure 45. CMRR vs. Frequency



Figure 48. Open-Loop Gain and Phase vs. Frequency

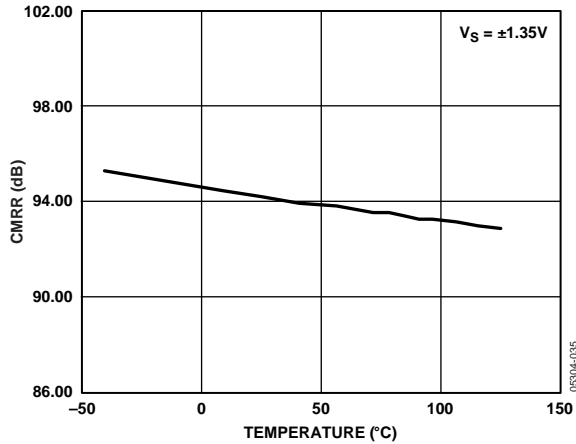

Figure 46. Large Signal CMRR vs. Temperature

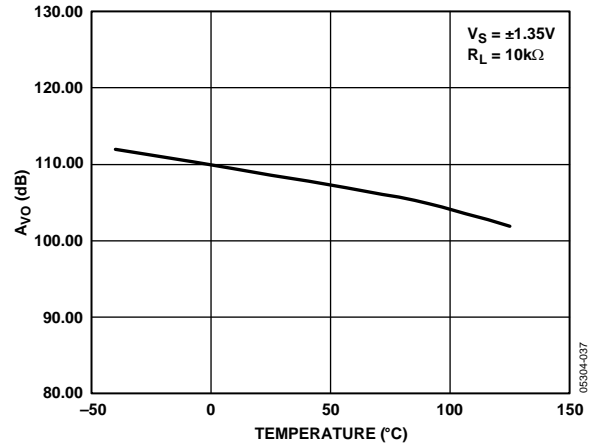

Figure 49. Large Signal Open-Loop Gain vs. Temperature



Figure 47. Small Signal PSSR vs. Frequency

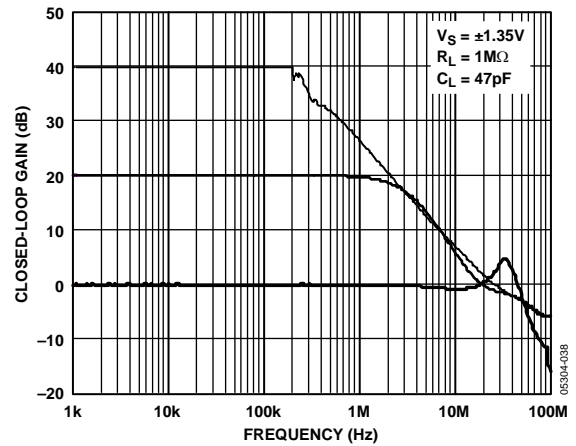

Figure 50. Closed-Loop Gain vs. Frequency



Figure 51. Maximum Output Swing vs. Frequency



Figure 53. Channel Separation vs. Frequency



Figure 52. Output Impedance vs. Frequency

THEORY OF OPERATION

The [AD8655/AD8656](#) amplifiers are voltage feedback, rail-to-rail input and output precision CMOS amplifiers, which operate from 2.7 V to 5.0 V of power supply voltage. These amplifiers use the Analog Devices DigiTrim technology to achieve a higher degree of precision than is available from most CMOS amplifiers. DigiTrim technology, used in a number of Analog Devices amplifiers, is a method of trimming the offset voltage of the amplifier after it is packaged. The advantage of post-package trimming is that it corrects any offset voltages caused by the mechanical stresses of assembly.

The [AD8655/AD8656](#) are available in standard op amp pinouts, making DigiTrim completely transparent to the user. The input stage of the amplifiers is a true rail-to-rail architecture, allowing the input common-mode voltage range of the amplifiers to extend to both positive and negative supply rails. The open-loop gain of the [AD8655/AD8656](#) with a load of 10 k Ω is typically 110 dB.

The [AD8655/AD8656](#) can be used in any precision op amp application. The amplifier does not exhibit phase reversal for common-mode voltages within the power supply. The [AD8655/AD8656](#) are great choices for high resolution data acquisition systems with voltage noise of 2.7 nV/ $\sqrt{\text{Hz}}$ and THD + Noise of -103 dB for a 2 V p-p signal at 10 kHz. Their low noise, sub-pA input bias current, precision offset, and high speed make them superb preamps for fast filter applications. The speed and output drive capability of the [AD8655/AD8656](#) also make them useful in video applications.

APPLICATIONS INFORMATION

INPUT OVERVOLTAGE PROTECTION

The internal protective circuitry of the [AD8655/AD8656](#) allows voltages exceeding the supply to be applied at the input. It is recommended, however, not to apply voltages that exceed the supplies by more than 0.3 V at either input of the amplifier. If a higher input voltage is applied, series resistors should be used to limit the current flowing into the inputs. The input current should be limited to less than 5 mA.

The extremely low input bias current allows the use of larger resistors, which allows the user to apply higher voltages at the inputs. The use of these resistors adds thermal noise, which contributes to the overall output voltage noise of the amplifier. For example, a 10 k Ω resistor has less than 12.6 nV/ $\sqrt{\text{Hz}}$ of thermal noise and less than 10 nV of error voltage at room temperature.

INPUT CAPACITANCE

Along with bypassing and ground, high speed amplifiers can be sensitive to parasitic capacitance between the inputs and ground. For circuits with resistive feedback network, the total capacitance, whether it is the source capacitance, stray capacitance on the input pin, or the input capacitance of the amplifier, causes a breakpoint in the noise gain of the circuit. As a result, a capacitor must be added in parallel with the gain resistor to obtain stability. The noise gain is a function of frequency and peaks at the higher frequencies, assuming the feedback capacitor is selected to make the second-order system critically damped. A few picofarads of capacitance at the input reduce the input impedance at high frequencies, which increases the amplifier's gain, causing peaking in the frequency response or oscillations. With the [AD8655/AD8656](#), additional input damping is required for stability with capacitive loads greater than 200 pF with direct input to output feedback. See the Driving Capacitive Loads section.

DRIVING CAPACITIVE LOADS

Although the [AD8655/AD8656](#) can drive capacitive loads up to 500 pF without oscillating, a large amount of ringing is present when operating the part with input frequencies above 100 kHz. This is especially true when the amplifiers are configured in positive unity gain (worst case). When such large capacitive loads are required, the use of external compensation is highly recommended. This reduces the overshoot and minimizes ringing, which, in turn, improves the stability of the [AD8655/AD8656](#) when driving large capacitive loads.

One simple technique for compensation is a snubber that consists of a simple RC network. With this circuit in place, output swing is maintained, and the amplifier is stable at all gains. Figure 55 shows the implementation of a snubber, which reduces overshoot by more than 30% and eliminates ringing. Using a snubber does not recover the loss of bandwidth incurred from a heavy capacitive load.



Figure 54. Driving Heavy Capacitive Loads Without Compensation



Figure 55. Snubber Network



Figure 56. Driving Heavy Capacitive Loads Using a Snubber Network

THD Readings vs. Common-Mode Voltage

Total harmonic distortion of the [AD8655/AD8656](#) is well below 0.0007% with a load of 1 kΩ. This distortion is a function of the circuit configuration, the voltage applied, and the layout, in addition to other factors.



Figure 57. THD + N Test Circuit

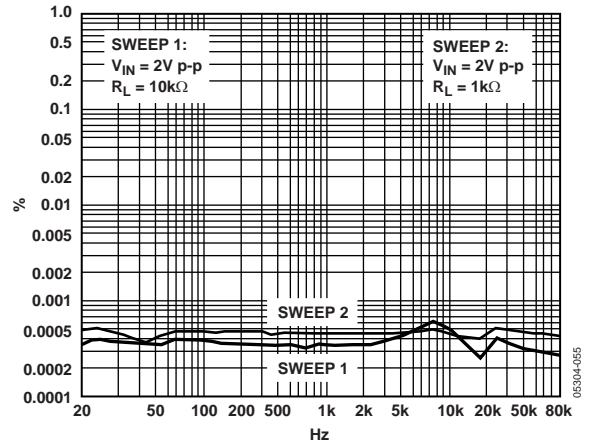

Figure 58. THD + Noise vs. Frequency

LAYOUT, GROUNDING, AND BYPASSING CONSIDERATIONS

POWER SUPPLY BYPASSING

Power supply pins can act as inputs for noise, so care must be taken to apply a noise-free, stable dc voltage. The purpose of bypass capacitors is to create low impedances from the supply to ground at all frequencies, thereby shunting or filtering most of the noise. Bypassing schemes are designed to minimize the supply impedance at all frequencies with a parallel combination of capacitors with values of 0.1 μF and 4.7 μF . Chip capacitors of 0.1 μF (X7R or NPO) are critical and should be as close as possible to the amplifier package. The 4.7 μF tantalum capacitor is less critical for high frequency bypassing, and, in most cases, only one is needed per board at the supply inputs.

GROUNDING

A ground plane layer is important for densely packed PC boards to minimize parasitic inductances. This minimizes voltage drops with changes in current. However, an understanding of where the current flows in a circuit is critical to implementing effective high speed circuit design. The length of the current path is directly proportional to the magnitude of parasitic inductances, and, therefore, the high frequency impedance of the path. Large changes in currents in an inductive ground return create unwanted voltage noise.

The length of the high frequency bypass capacitor leads is critical, and, therefore, surface-mount capacitors are recommended. A parasitic inductance in the bypass ground trace works against the low impedance created by the bypass capacitor. Because load currents flow from the supplies, the ground for the load impedance should be at the same physical location as the bypass capacitor grounds. For larger value capacitors intended to be effective at lower frequencies, the current return path distance is less critical.

LEAKAGE CURRENTS

Poor PC board layout, contaminants, and the board insulator material can create leakage currents that are much larger than the input bias current of the [AD8655/AD8656](#). Any voltage differential between the inputs and nearby traces creates leakage currents through the PC board insulator, for example, 1 V/100 $\text{G}\Omega = 10 \text{ pA}$. Similarly, any contaminants on the board can create significant leakage (skin oils are a common problem).

To significantly reduce leakage, put a guard ring (shield) around the inputs and input leads that are driven to the same voltage potential as the inputs. This ensures there is no voltage potential between the inputs and the surrounding area to create any leakage currents. To be effective, the guard ring must be driven by a relatively low impedance source and should completely surround the input leads on all sides, above and below, by using a multilayer board.

The charge absorption of the insulator material itself can also cause leakage currents. Minimizing the amount of material between the input leads and the guard ring helps to reduce the absorption. Also, using low absorption materials, such as Teflon® or ceramic, may be necessary in some instances.

OUTLINE DIMENSIONS



Figure 59. 8-Lead Standard Small Outline Package [SOIC_N] Narrow Body (R-8)
Dimensions shown in millimeters and (inches)

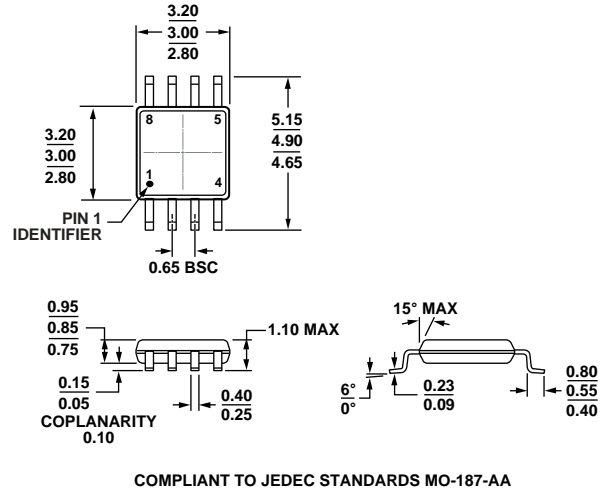

Figure 60. 8-Lead Mini Small Outline Package [MSOP] (RM-8)
Dimensions shown in millimeters

ORDERING GUIDE

Model ^{1,2}	Temperature Range	Package Description	Package Option	Branding
AD8655ARZ	-40°C to +125°C	8-Lead SOIC_N	R-8	
AD8655ARZ-REEL	-40°C to +125°C	8-Lead SOIC_N	R-8	
AD8655ARZ-REEL7	-40°C to +125°C	8-Lead SOIC_N	R-8	
AD8655ARMZ-REEL	-40°C to +125°C	8-Lead MSOP	RM-8	A0D
AD8655ARMZ	-40°C to +125°C	8-Lead MSOP	RM-8	A0D
AD8655WARMZ-RL	-40°C to +125°C	8-Lead MSOP	RM-8	A0D
AD8656ARZ	-40°C to +125°C	8-Lead SOIC_N	R-8	
AD8656ARZ-REEL	-40°C to +125°C	8-Lead SOIC_N	R-8	
AD8656ARZ-REEL7	-40°C to +125°C	8-Lead SOIC_N	R-8	
AD8656ARMZ	-40°C to +125°C	8-Lead MSOP	RM-8	A0S
AD8656ARMZ-REEL	-40°C to +125°C	8-Lead MSOP	RM-8	A0S
AD8656WARMZ-REEL	-40°C to +125°C	8-Lead MSOP	RM-8	A0S

¹ Z = RoHS Compliant Part.

² W = Qualified for Automotive Applications.

AUTOMOTIVE PRODUCTS

The [AD8655W](#) model and the [AD8656W](#) model are available with controlled manufacturing to support the quality and reliability requirements of automotive applications. Note that these automotive models may have specifications that differ from the commercial models; therefore, designers should review the Specifications section of this data sheet carefully. Only the automotive grade products shown are available for use in automotive applications. Contact your local Analog Devices account representative for specific product ordering information and to obtain the specific Automotive Reliability reports for this model.

NOTES