

REVISIONS

P	LTR	DESCRIPTION	DATE	DWN	APVD
	BA1	ECR-14-009193	19JUN2014	KR	TN

FOR FURTHER INFORMATION SEE DATA SHEET FOR
CPF SERIES-THIN FILM PRECISION CHIP RESISTORS

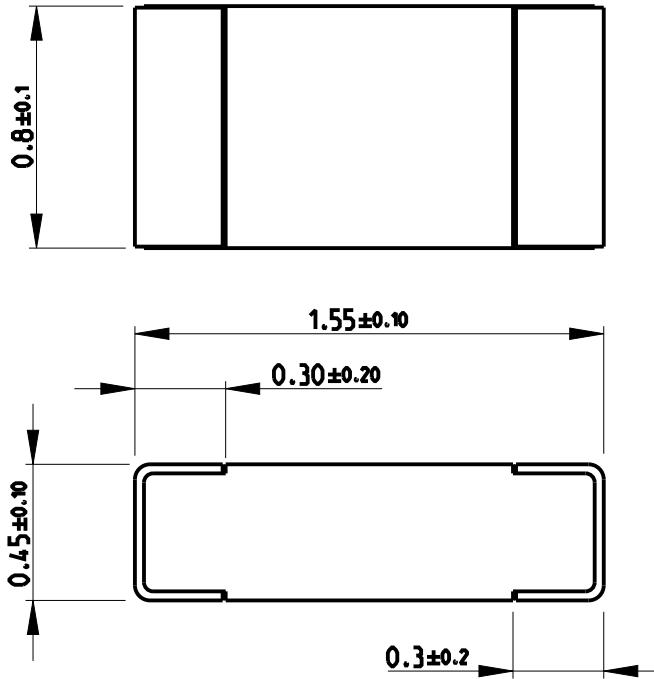

RoHS Compliant

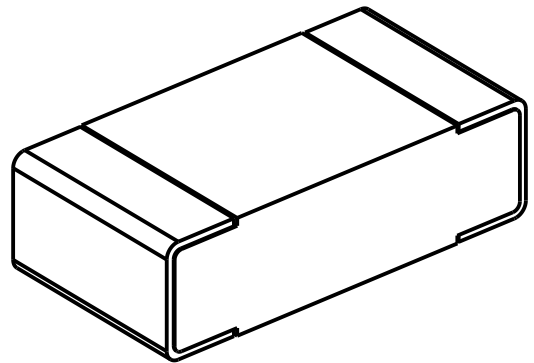

2008

RELEASED FOR PUBLICATION

ALL RIGHTS RESERVED.

BY -

© COPYRIGHT 2008

THIS DRAWING IS UNPUBLISHED.

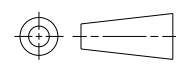
DIMENSIONS: mm		DWN SUBHASH.M 29-Sep-08	MATERIAL	FINISH
TOLERANCES UNLESS OTHERWISE SPECIFIED:		CHK PRAKASH.S 29-Sep-08	 TE Connectivity	
0 PLC ±0.2	1 PLC ±0.1	APVD STEPHEN.P 29-Sep-08		
2 PLC ±	3 PLC ±	PRODUCT SPEC	NAME THIN FILM PRECISION CHIP RESISTORS SERIES CPF 0603	
4 PLC ±	ANGLES 5°	APPLICATION SPEC	SIZE	CAGE CODE
		WEIGHT	A 4	00779
Customer Drawing			DRAWING NO	RESTRICTED TO
			C-1879334	-
			SCALE	SHEET
			40:1	1 OF 1
				REV
				BA1