

Product Summary

BV _{DSS}	R _{DS(ON)} Max	I _D Max T _C = +25°C
60V	25mΩ @ V _{GS} = 10V	32A
	40mΩ @ V _{GS} = 4.5V	25A

Description

This MOSFET is designed to minimize the on-state resistance (R_{DS(ON)}) yet maintain superior switching performance making it ideal for high efficiency power management applications.

Applications

- Backlighting
- Power-Management Functions
- DC-DC Converters

Features and Benefits

- Rated to +175°C — Ideal for High Ambient Temperature Environments
- 100% Unclamped Inductive Switching — Ensures More Reliable and Robust End Application
- High-Conversion Efficiency
- Low R_{DS(ON)} — Minimizes On-State Losses
- Low-Input Capacitance
- Fast-Switching Speed
- Wettable Flank for Improved Optical Inspections
- **Totally Lead-Free & Fully RoHS Compliant (Notes 1 & 2)**
- **Halogen and Antimony Free. "Green" Device (Note 3)**
- **An Automotive-Compliant Part is Available Under Separate Datasheet ([DMNH6021SPDWQ](#))**

Mechanical Data

- Case: PowerDI[®] 5060-8
- Case Material: Molded Plastic, "Green" Molding Compound. UL Flammability Classification Rating 94V-0
- Moisture Sensitivity: Level 3 per J-STD-020
- Terminal Connections Indicator: See Diagram
- Terminals: Finish — Matte Tin Annealed Over Copper Leadframe. Solderable per MIL-STD-202, Method 208 ⁽³⁾
- Weight: 0.097 grams (Approximate)

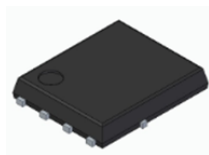

Top View

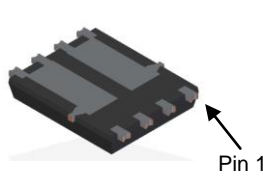

Bottom View

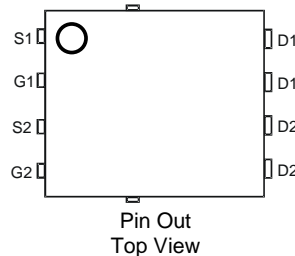

Pin Out
Top View

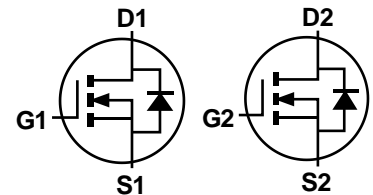

Equivalent Circuit

Ordering Information (Note 4)

Part Number	Case	Packaging
DMNH6021SPDW-13	PowerDI5060-8 (SWP) (Type R)	2500 / Tape & Reel

- Notes:
1. No purposely added lead. Fully EU Directive 2002/95/EC (RoHS), 2011/65/EU (RoHS 2) & 2015/863/EU (RoHS 3) compliant.
 2. See <https://www.diodes.com/quality/lead-free/> for more information about Diodes Incorporated's definitions of Halogen- and Antimony-free, "Green" and Lead-free.
 3. Halogen- and Antimony-free "Green" products are defined as those which contain <900ppm bromine, <900ppm chlorine (<1500ppm total Br + Cl) and <1000ppm antimony compounds.
 4. For packaging details, go to our website at <https://www.diodes.com/design/support/packaging/diodes-packaging/>.

Marking Information

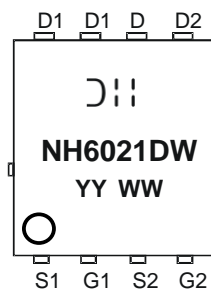

⌋⌋ = Manufacturer's Marking
 NH6021DW = Product Type Marking Code
 YYWW = Date Code Marking
 YY = Year (ex: 19 = 2019)
 WW = Week (01 to 53)

Maximum Ratings (@T_A = +25°C, unless otherwise specified.)

Characteristic	Symbol	Value	Unit
Drain-Source Voltage	V _{DSS}	60	V
Gate-Source Voltage	V _{GSS}	±20	V
Continuous Drain Current (Note 6) V _{GS} = 10V	I _D	T _A = +25°C	8.2
		T _A = +70°C	6.5
Continuous Drain Current (Note 7) V _{GS} = 10V	I _D	T _C = +25°C	32
		T _C = +100°C	22
Pulsed Drain Current (380µs Pulse, Duty Cycle = 1%)	I _{DM}	80	A
Maximum Continuous Body Diode Forward Current (Note 7)	I _S	32	A
Avalanche Current, L = 0.1mH (Note 8)	I _{AS}	35	A
Avalanche Energy, L = 0.1mH (Note 8)	E _{AS}	64	mJ

Thermal Characteristics (@T_A = +25°C, unless otherwise specified.)

Characteristic	Symbol	Value	Unit
Total Power Dissipation (Note 5)	P _D	1.5	W
Thermal Resistance, Junction to Ambient (Note 5)	R _{θJA}	Steady State	99
		t < 10s	53
Total Power Dissipation (Note 6)	P _D	2.8	W
Thermal Resistance, Junction to Ambient (Note 6)	R _{θJA}	Steady State	54
		t < 10s	27
Thermal Resistance, Junction to Case (Note 7)	R _{θJC}	2.2	°C/W
Operating and Storage Temperature Range	T _J , T _{STG}	-55 to +175	°C

Electrical Characteristics (@T_A = +25°C, unless otherwise specified.)

Characteristic	Symbol	Min	Typ	Max	Unit	Test Condition
OFF CHARACTERISTICS (Note 9)						
Drain-Source Breakdown Voltage	BV _{DSS}	60	—	—	V	V _{GS} = 0V, I _D = 250µA
Zero Gate Voltage Drain Current T _J = +25°C	I _{DSS}	—	—	1	µA	V _{DS} = 60V, V _{GS} = 0V
Gate-Source Leakage	I _{GSS}	—	—	±100	nA	V _{GS} = ±20V, V _{DS} = 0V
ON CHARACTERISTICS (Note 9)						
Gate Threshold Voltage	V _{GS(TH)}	1	—	3	V	V _{DS} = V _{GS} , I _D = 250µA
Static Drain-Source On-Resistance	R _{DS(ON)}	—	15	25	mΩ	V _{GS} = 10V, I _D = 15A
		—	21	40		V _{GS} = 4.5V, I _D = 12A
Diode Forward Voltage	V _{SD}	—	0.75	1.2	V	V _{GS} = 0V, I _S = 2.6A
DYNAMIC CHARACTERISTICS (Note 10)						
Input Capacitance	C _{iss}	—	1,143	—	pF	V _{DS} = 25V, V _{GS} = 0V, f = 1MHz
Output Capacitance	C _{oss}	—	168	—	pF	
Reverse Transfer Capacitance	C _{rss}	—	69	—	pF	
Gate Resistance	R _g	—	2.5	—	Ω	V _{DS} = 0V, V _{GS} = 0V, f = 1MHz
Total Gate Charge (V _{GS} = 10V)	Q _g	—	20.1	—	nC	V _{DS} = 30V, I _D = 20A
Total Gate Charge (V _{GS} = 6V)	Q _g	—	12	—	nC	
Gate-Source Charge	Q _{gs}	—	4.3	—	nC	
Gate-Drain Charge	Q _{gd}	—	5.5	—	nC	
Turn-On Delay Time	t _{D(ON)}	—	4.4	—	ns	V _{DD} = 30V, V _{GS} = 10V, R _g = 4.7Ω, I _D = 20A
Turn-On Rise Time	t _r	—	6.0	—	ns	
Turn-Off Delay Time	t _{D(OFF)}	—	14.2	—	ns	
Turn-Off Fall Time	t _f	—	5.4	—	ns	
Body Diode Reverse Recovery Time	t _{RR}	—	21.2	—	ns	I _F = 20A, di/dt = 100A/µs
Body Diode Reverse Recovery Charge	Q _{RR}	—	15.2	—	nC	

- Notes:
- Device mounted on FR-4 PC board with minimum recommended pad layout, single sided.
 - Device mounted on FR-4 substrate PC board, 2oz copper, with thermal bias to bottom layer 1inch square copper plate.
 - Thermal resistance from junction to soldering point (on the exposed drain pad).
 - I_{AS} and E_{AS} ratings are based on low frequency and duty cycles to keep T_J = +25°C.
 - Short duration pulse test used to minimize self-heating effect.
 - Guaranteed by design. Not subject to product testing.

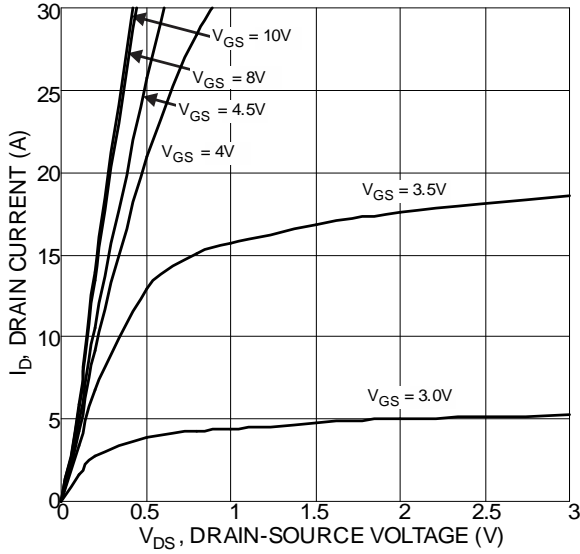

Figure 1 Typical Output Characteristic

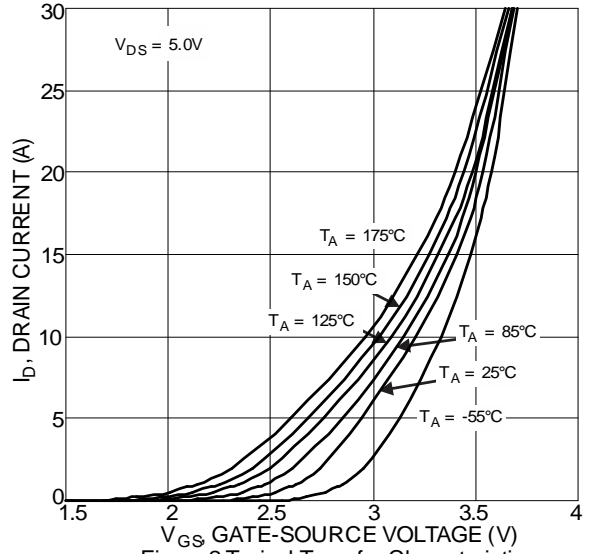

Figure 2 Typical Transfer Characteristics

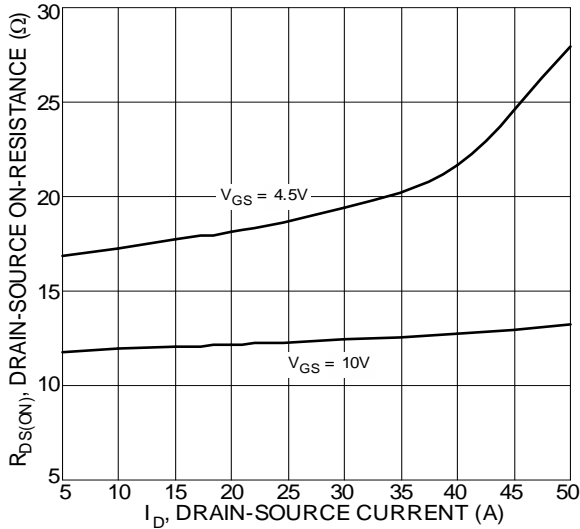

Figure 3 Typical On-Resistance vs. Drain Current and Gate Voltage

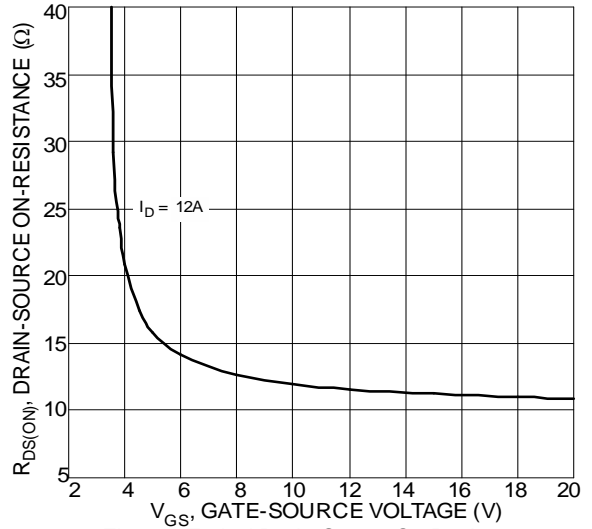

Figure 4 Typical Drain-Source On-Resistance vs. Gate-Source Voltage

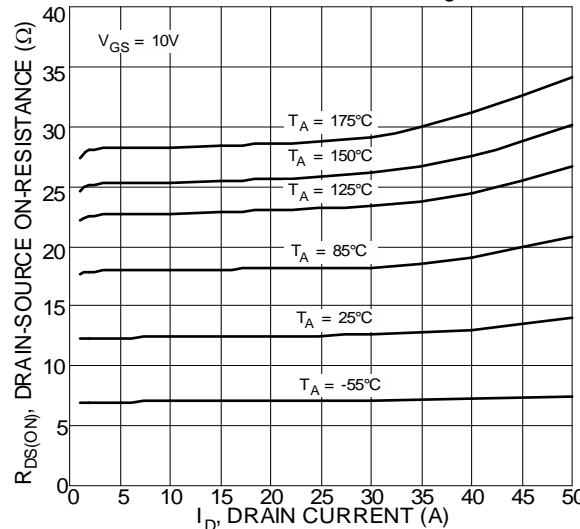

Figure 5 Typical On-Resistance vs. Drain Current and Temperature

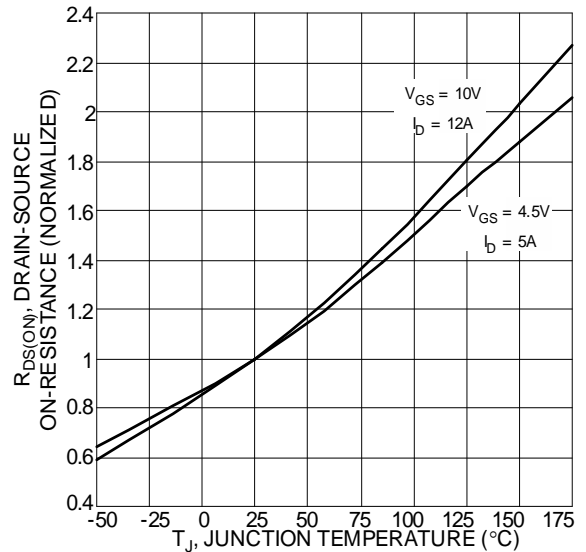
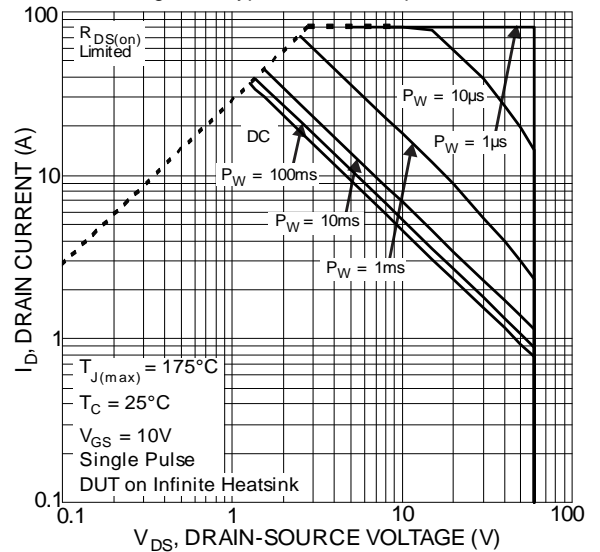
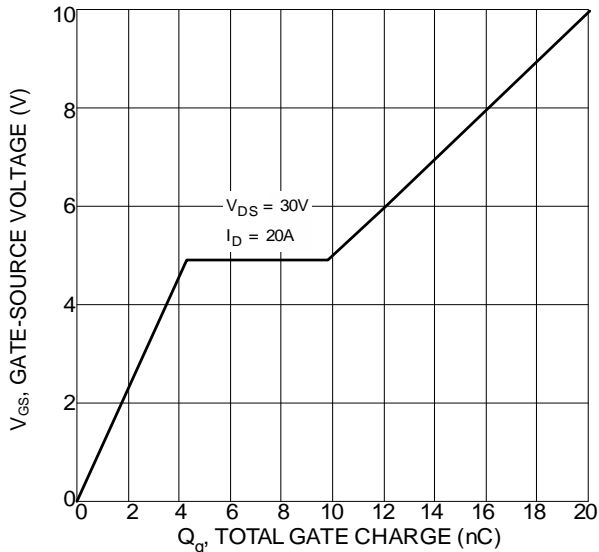
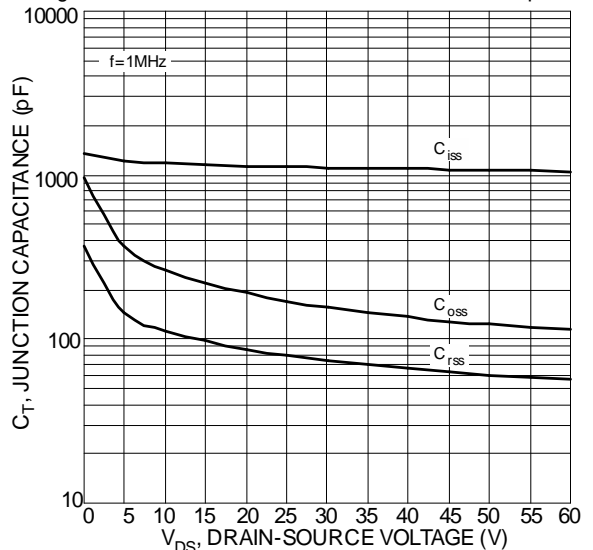
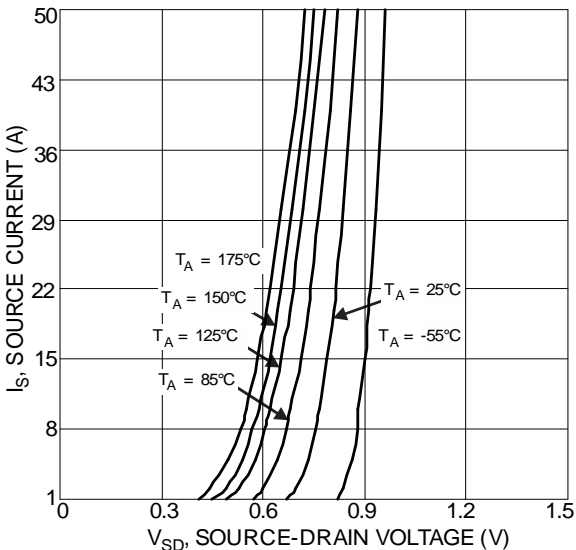
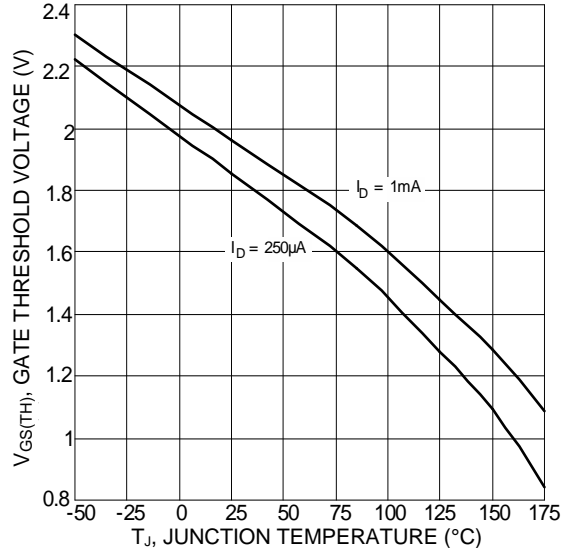
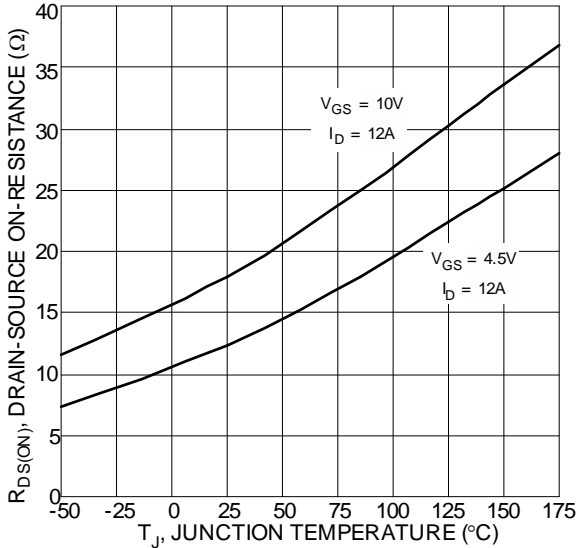
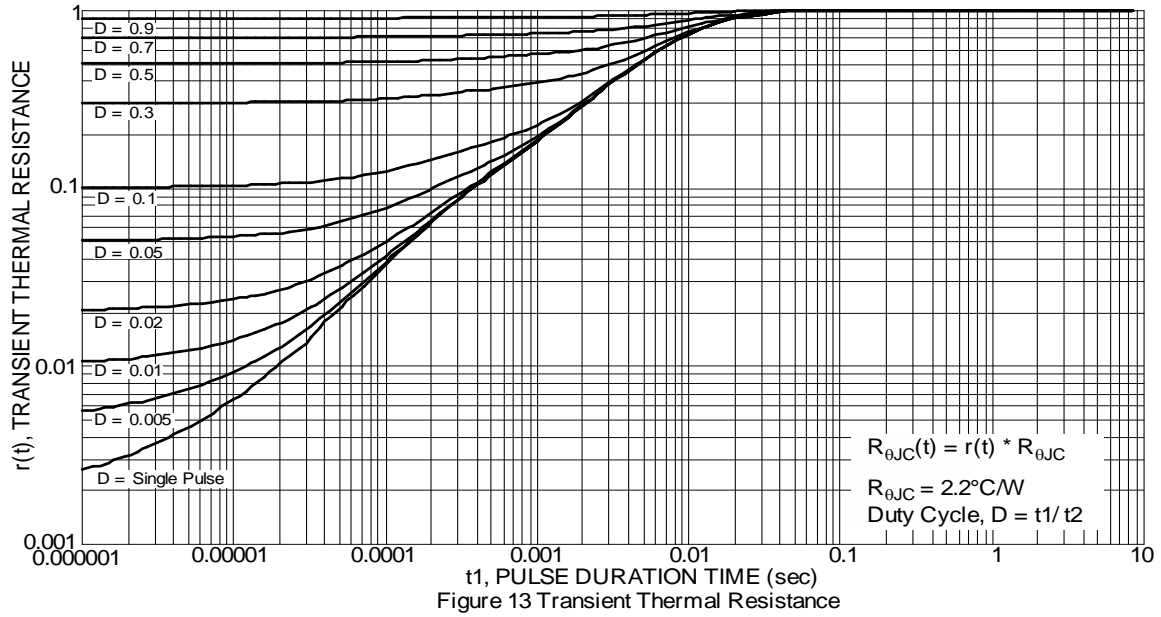

Figure 6 On-Resistance Variation with Temperature





Package Outline Dimensions

Please see <http://www.diodes.com/package-outlines.html> for the latest version.

PowerDI5060-8 (SWP) (Type R)

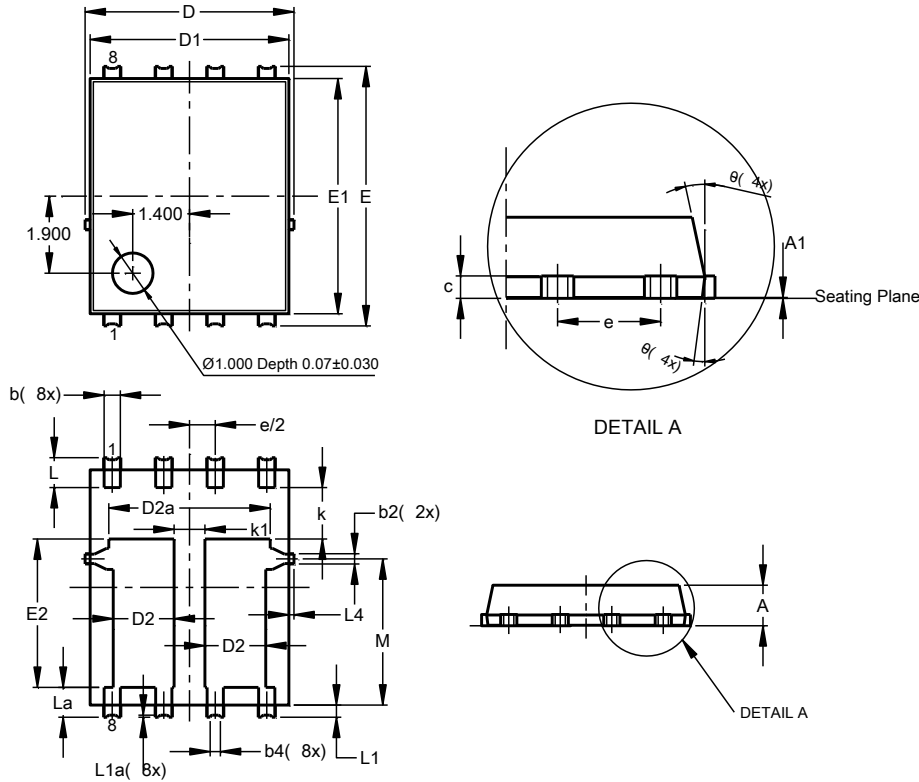

PowerDI5060-8 (SWP) (Type R)			
Dim	Min	Max	Typ
A	0.90	1.10	1.00
A1	0	0.05	--
b	0.30	0.50	0.41
b2	0.20	0.35	0.25
b4	0.25REF		
c	0.230	0.330	0.277
D	5.15 BSC		
D1	4.70	5.10	4.90
D2	1.40	1.60	1.50
D2a	3.78	4.18	3.98
E	6.40 BSC		
E1	5.60	6.00	5.80
E2	3.46	3.86	3.66
e	1.27BSC		
k	1.05	--	--
k1	0.56	--	--
L	0.635	0.835	0.735
La	0.635	0.835	0.735
L1	0.200	0.400	0.300
L1a	0.050REF		
L4	0.025	0.225	0.125
M	3.205	4.005	3.605
theta	10°	12°	11°
theta1	6°	8°	7°
All Dimensions in mm			

Suggested Pad Layout

Please see <http://www.diodes.com/package-outlines.html> for the latest version.

PowerDI5060-8 (SWP) (Type R)

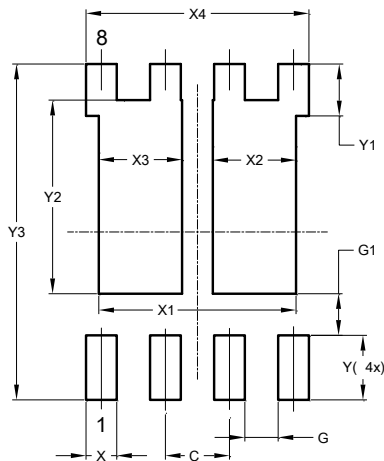

Dimensions	Value (in mm)
C	1.270
G	0.660
G1	0.820
X	0.610
X1	3.910
X2	1.650
X3	1.650
X4	4.420
Y	1.270
Y1	1.020
Y2	3.810
Y3	6.610

IMPORTANT NOTICE

DIODES INCORPORATED MAKES NO WARRANTY OF ANY KIND, EXPRESS OR IMPLIED, WITH REGARDS TO THIS DOCUMENT, INCLUDING, BUT NOT LIMITED TO, THE IMPLIED WARRANTIES OF MERCHANTABILITY AND FITNESS FOR A PARTICULAR PURPOSE (AND THEIR EQUIVALENTS UNDER THE LAWS OF ANY JURISDICTION).

Diodes Incorporated and its subsidiaries reserve the right to make modifications, enhancements, improvements, corrections or other changes without further notice to this document and any product described herein. Diodes Incorporated does not assume any liability arising out of the application or use of this document or any product described herein; neither does Diodes Incorporated convey any license under its patent or trademark rights, nor the rights of others. Any Customer or user of this document or products described herein in such applications shall assume all risks of such use and will agree to hold Diodes Incorporated and all the companies whose products are represented on Diodes Incorporated website, harmless against all damages.

Diodes Incorporated does not warrant or accept any liability whatsoever in respect of any products purchased through unauthorized sales channel. Should Customers purchase or use Diodes Incorporated products for any unintended or unauthorized application, Customers shall indemnify and hold Diodes Incorporated and its representatives harmless against all claims, damages, expenses, and attorney fees arising out of, directly or indirectly, any claim of personal injury or death associated with such unintended or unauthorized application.

Products described herein may be covered by one or more United States, international or foreign patents pending. Product names and markings noted herein may also be covered by one or more United States, international or foreign trademarks.

This document is written in English but may be translated into multiple languages for reference. Only the English version of this document is the final and determinative format released by Diodes Incorporated.

LIFE SUPPORT

Diodes Incorporated products are specifically not authorized for use as critical components in life support devices or systems without the express written approval of the Chief Executive Officer of Diodes Incorporated. As used herein:

A. Life support devices or systems are devices or systems which:

1. are intended to implant into the body, or
2. support or sustain life and whose failure to perform when properly used in accordance with instructions for use provided in the labeling can be reasonably expected to result in significant injury to the user.

B. A critical component is any component in a life support device or system whose failure to perform can be reasonably expected to cause the failure of the life support device or to affect its safety or effectiveness.

Customers represent that they have all necessary expertise in the safety and regulatory ramifications of their life support devices or systems, and acknowledge and agree that they are solely responsible for all legal, regulatory and safety-related requirements concerning their products and any use of Diodes Incorporated products in such safety-critical, life support devices or systems, notwithstanding any devices- or systems-related information or support that may be provided by Diodes Incorporated. Further, Customers must fully indemnify Diodes Incorporated and its representatives against any damages arising out of the use of Diodes Incorporated products in such safety-critical, life support devices or systems.

Copyright © 2019, Diodes Incorporated

www.diodes.com