

PRODUCT NO.  
10108777-X0XXXX

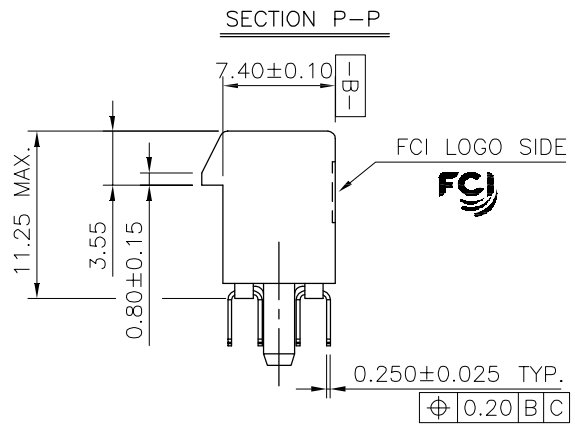
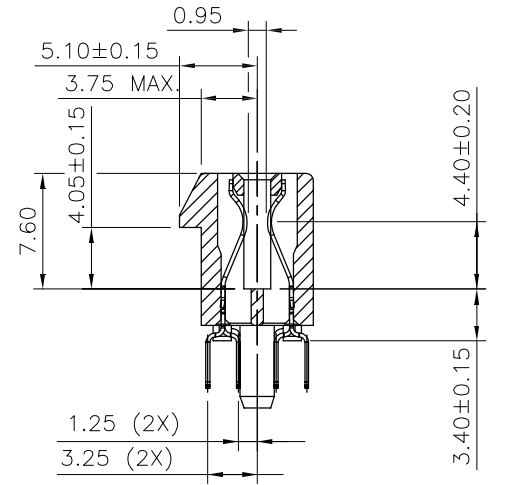
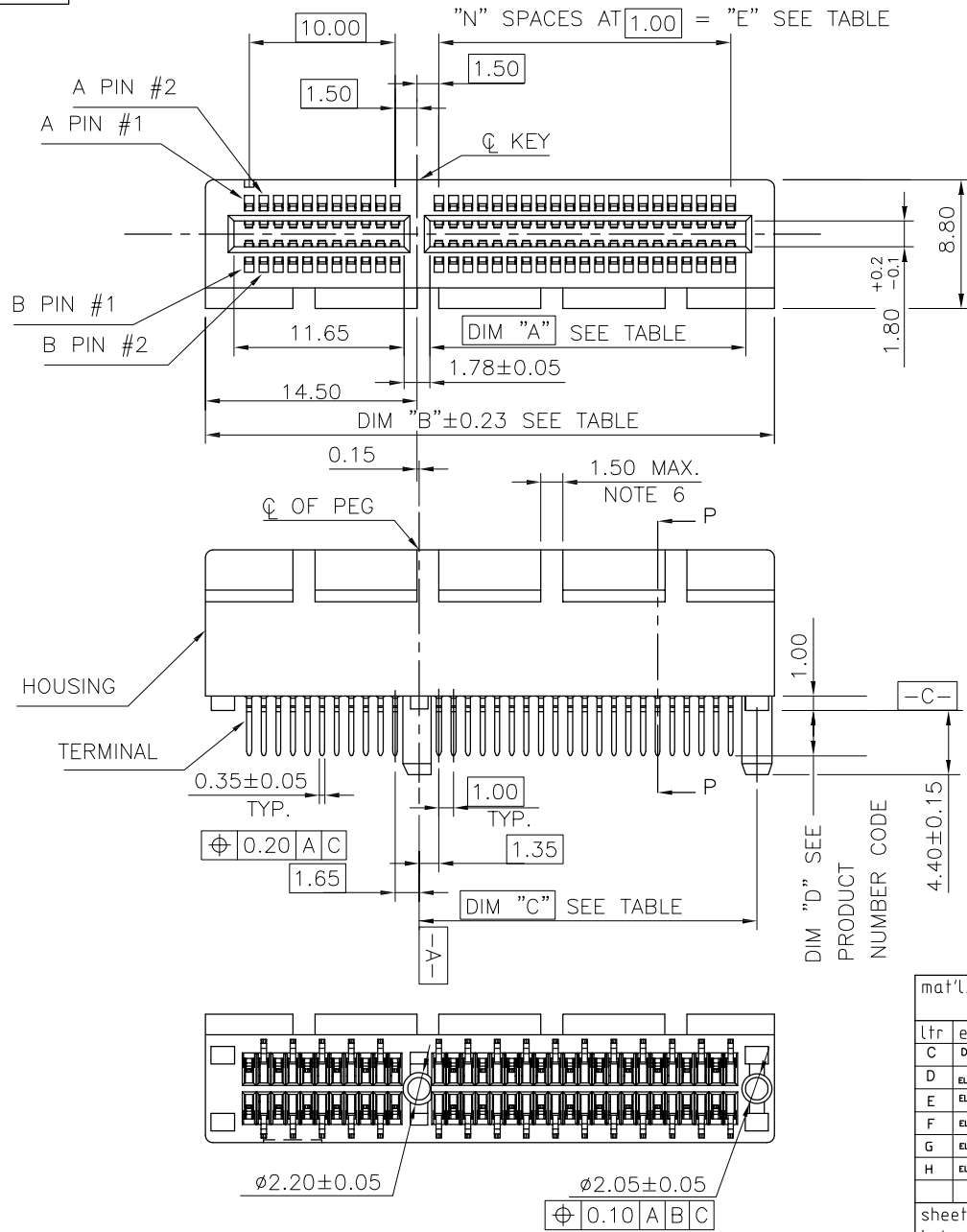

TWIN PLASTIC PEG TYPE

mat'l. code		surface		tolerance		projection		product family	
-		-		ASME_Y14.5		$\phi$		PCI_EXPRESS	
lfr		ecn no		dr		date		title	
C		DG-011582		HT		5/10/12		PCI_EXPRESS_CARD_EDGE_GEN3	
D		ELX-DG-013209		WL		07/24/12		TH_ASS'Y	
E		ELX-DG-2181-1		ST		05/27/15		dwg no	
F		ELX-DG-24164		ZH		05/30/16		sheet 1 of 7	
G		ELX-DG-25671		ZH		12/18/16		size	
H		ELX-DG-27937		ZH		09/12/17		10108777	
								A4	
								type	
								CUSTOMER Drawing	
sheet index		revision sheet		H					

PRODUCT NO.  
10108777-X2XXXX

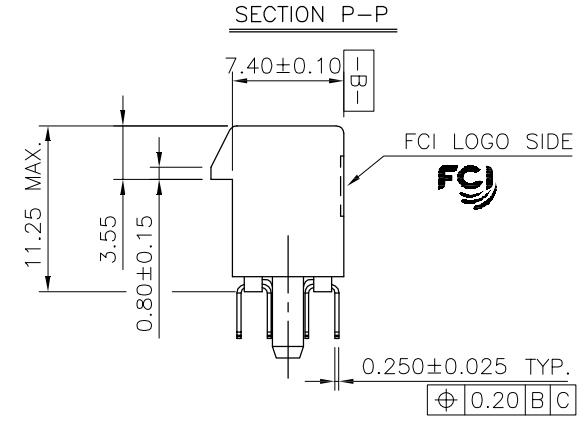

**SINGLE PLASTIC PEG TYPE**

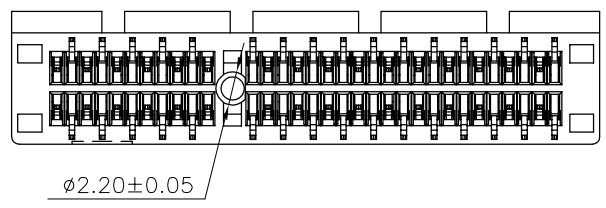

mat'l. code		-		surface		- ✓		tolerance		ASME_Y14.5		projection		product family		PCI_EXPRESS	
lfr		ecn no		dr		date		tolerances unless otherwise specified		angles		MM		title		PCI_EXPRESS_CARD_EDGE_GEN3	
								±2'		LineGr		scale N/A		TH_ASS'Y		5	
				dr		ZHENHUA_LIU		2016-03-30		Amphenol FCI		dwg no		sheet 2 of 7		size	
				enfr		ZHENHUA_LIU		2016-03-30				10108777				A4	
				chr		STONE_LI		2016-03-30				type		CUSTOMER Drawing		B	
				appd		PM_ZHENG		2016-03-30									
sheet index		revision sheet		H													



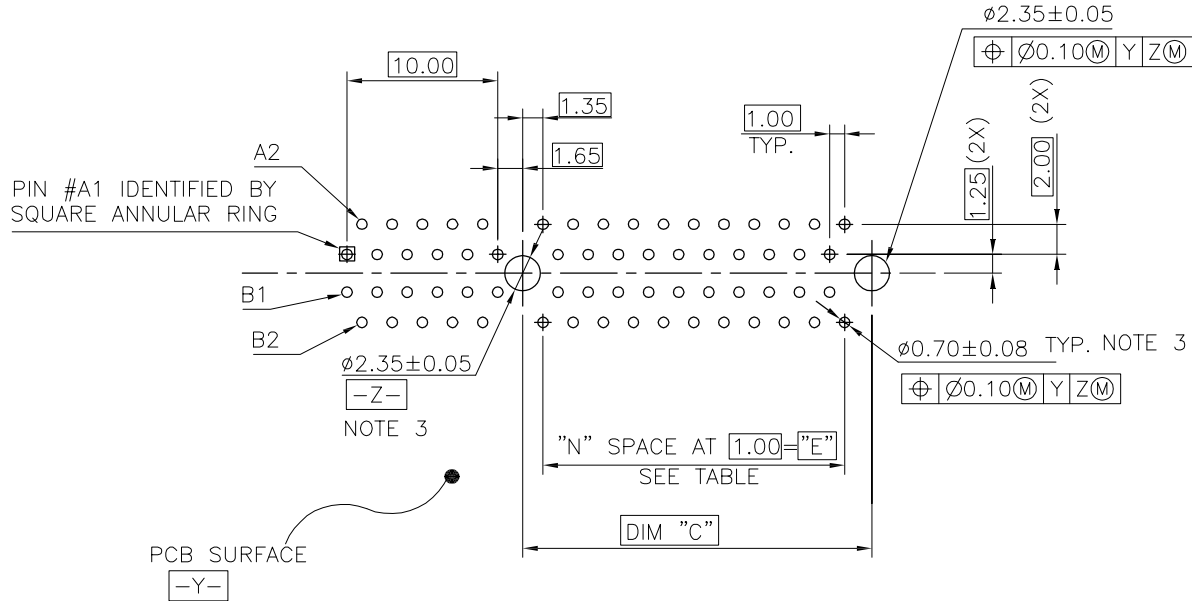

← I/O PANEL DIRECTION

RECOMMENDED FOOTPRINT

mat'l. code		surface		tolerance		projection		product family	
-		-		ASME_Y14.5				PCI_EXPRESS	
lfr		ecn no		dr		date		tolerances unless otherwise specified	
								title	
								MM	
								PCI_EXPRESS_CARD_EDGE_GEN3	
								TH_ASS'Y	
								scale N/A	
								dwg no	
								sheet 4 of 7	
								size	
								A4	
								type	
								CUSTOMER Drawing	
sheet index		revision sheet		H					



SCALE 2:1

← I/O PANEL DIRECTION  
PRIMARY (COMPONENT) SIDE



I/O PANEL DIRECTION →  
SECONDARY (SOLDER) SIDE

PIN "F" SEE TABLE 2.40±0.10  
NOTE 4

PIN "F" SEE TABLE 2.40±0.10  
NOTE 4

#	POS REF.	N	DIM "G"	"F"
36		6	8.15	B17
64		20	22.15	B31
98		37	39.15	B48
164		70	72.15	B81

ADD-IN CARD EDGE-FINGER DIMENSIONS

mat'l. code		-		surface		- ✓		tolerance		ASME_Y14.5		projection		product family		PCI_EXPRESS	
lfr		ecn no		dr		date		tolerances unless otherwise specified		MM		title		PCI_EXPRESS_CARD_EDGE_GEN3 TH_ASS'Y			
								angles		.0±0.20		scale N/A		dwg no		sheet 5 of 7 size	
								±2'		.00±0.13		Amphenol FCI		10108777		A4	
				dr		ZHENHUA_LIU		2016-03-30						type		CUSTOMER Drawing	
				enfr		ZHENHUA_LIU		2016-03-30									
				chr		STONE_LI		2016-03-30									
				appd		PM_ZHENG		2016-03-30									
sheet index		revision sheet		H													

NOTES:

1.MATERIAL:

HOUSING: HIGH TEMPERATURE NYLON, GLASS FILLED UL94V-0 RATED.  
TERMINAL: COPPER ALLOY.

PLATING: 50u" NICKEL UNDERPLATE ALL OVER  
CONTACT AREA PLATING - SEE PRODUCT NUMBER CODE  
SOLDER TAIL: TIN OR TIN /LEAD(90/10)- SEE PRODUCT NUMBER CODE 100u" MIN. OVER 50u" NICKEL.

METAL BOARD LOCKS: COPPER ALLOY.  
FINISH: 100u" TIN OR TIN/LEAD(90/10) OVER 50u" NICKEL  
UNDERPLATE SEE PRODUCT NUMBER CODE.

2.PRODUCT SPECIFICATION: GS-12-233.

③THE HORIZONTAL AXIS FOR THE HOLE PATTERN IS ESTABLISHED BY

A LINE THROUGH THE CENTER OF THE TWO Ø2.35 HOLES.  
THE VERTICAL AXIS IS 90° TO THE HORIZONTAL AXIS, THROUGH THE CENTER OF DATUM Z.

④NO TIE BAR PERMITTED FROM CARD EDGE TO LEADING EDGE OF PAD FOR PINS A1 AND PIN NUMBERS "F".

⑤CHAMFER EDGES MUST BE FREE OF CUTTING BURRS.

⑥FREQUENCY & LOCATION AT SUPPLIER DISCRETION. RIDGE MAY BE CONTINUOUS WITH NO BREAKS.

7.RoHS COMPATIBLE PRODUCT SPECIFICATIONS:

a - PLATING:

- "LF" MEANS THE PRODUCT IS LEAD-FREE, 2um MINIMUM MATTE TIN OVER 1.27um MINIMUM NICKEL UNDERPLATE.

b - MANUFACTURING PROCESS COMPATIBILITY:

- THE HOUSING WILL WITHSTAND EXPOSURE TO 260°C±5°C TEMPERATURE FOR 10 SECONDS IN RE-FLOW APPLICATION, SEE NOTE 8 FOR APPLICATION.

PRODUCT NUMBER CODE

10108777 -X X X X X X

HOUSING COLOR OPTIONS

- 0-NATURAL
- 1-BLACK

PEGS OPTIONS

- 0-PLASTIC PEGS, DIM
- 1-METAL BOARD LOCKS
- 2-SINGLE PLASTIC PEGS

TERMINAL PLATING OPTIONS

- 0-50u" Ni UNDERPLATE  
30u" Au CONTACT AREA  
100u" TIN TAIL AREA ----- COMPATIBLE RoHS
- 1-50u" Ni UNDERPLATE  
15u" Au CONTACT AREA  
100u" TIN TAIL AREA ----- COMPATIBLE RoHS
- 2-50u" Ni UNDERPLATE  
GOLD FLASH CONTACT AREA  
100u" TIN TAIL AREA ----- COMPATIBLE RoHS
- 3-50u" Ni UNDERPLATE  
30u" Au CONTACT AREA  
100u" TIN/LEAD TAIL AREA ---INCOMPLIANT RoHS
- 4-50u" Ni UNDERPLATE  
15u" Au CONTACT AREA  
100u" TIN/LEAD TAIL AREA ---INCOMPLIANT RoHS
- 5-50u" Ni UNDERPLATE  
GOLD FLASH CONTACT AREA  
100u" TIN/LEAD TAIL AREA ---INCOMPLIANT RoHS

LEAD FREE OPTION

LEAVE BLANK FOR TERMINAL PLATING 3.4.5  
"LF" FOR TERMINAL PLATING OPTION 0,1,2

POS OPTIONS

- 0-36
- 1-64
- 2-98
- 3-164

TAIL LENGTH OPTIONS

	DIM "D"	PCB THICKNESS	DIM "G"
0	2.30 <sup>+0.25</sup> / <sub>-0.13</sub>	1.56±0.10	1.70±0.15
1	3.10 <sup>+0.25</sup> / <sub>-0.13</sub>	2.36±0.10	2.50±0.15
2	2.54±0.25	1.56±0.10	1.70±0.15
3	1.90±0.25	1.56±0.10	1.70±0.15
4	3.10 <sup>+0.25</sup> / <sub>-0.13</sub>	2.0±0.10	1.70±0.15

CONNECTOR	# POS REF.	N	DIM "A"	DIM "B"	DIM "C"	"E"
1 PORT	36	6	7.65	25.00	9.15	6.00
4 PORT	64	20	21.65	39.00	23.15	20.00
8 PORT	98	37	38.65	56.00	40.15	37.00
16 PORT	164	70	71.65	89.00	73.15	70.00

- 8.AN ADEQUATE PROCEDURE SET FORTH IN THE FOLLOWING ENSURE THAT THE PRODUCT RELIABILITY CAN BE ACHIEVED DURING AND AFTER PCB ASSEMBLY OPERATION.
- 8.1IF PARTIAL LOT ARE USED, THE REMAINING CONNECTORS MUST BE RESEALED AND PLACED IN SAFE STORAGE WITHIN SIX HOURS OF BAG OPENING.
- 8.2THE SAFE STORAGE CONDITION IS RECOMMENDED AT 25°C, 40%RH.
- 8.3NOT FOLLOWING THE PROCEDURE MAY CAUSE BLISTER DAMAGE DURING RE-FLOW PROCESS.
- 8.4IF BAKING IS REQUIRED, CONNECTOR SHALL BE BAKED FOR 4 HOURS AT 125°C.
- 8.5REFERENCE SPECIFICATION: IPC/JEDEC J-STD-033A.

PACKAGING OPTIONS

- E-HARD TRAY WITH MYLAR FOR VACUUM PACKAGING (FOR 164P ONLY)
- T-SOFT TRAY PACKAGING
- C-SOFT TRAY PACKAGING WITH 10MM CAP
- M-SOFT TRAY PACKAGING & MYLAR TAPE. SEE FIGURE 1
- Y-HARD TRAY PACKAGING (FOR 36P,98P AND 164P ONLY)
- Z-HARD TRAY PACKAGING WITH MYLAR (FOR 36P,98P AND 164P ONLY)
- H-SMALLER HARD TRAY PACKAGING WITH 30MM CAP (323X136X17.7 FOR 164P ONLY)
- △ Q-SMALLER HARD TRAY PACKAGING (323X136X17.7 FOR 164P ONLY)
- R-TAPE & REEL PACKAGING WITHOUT MYLAR (FOR 34, 64, 98P ONLY)
- W-TAPE & REEL PACKAGING WITHOUT MYLAR (FOR 98P ONLY), WITH 18.0MM CAVITY WIDTH
- A-TAPE & REEL PACKAGING WITH MYLAR (FOR 36, 64, 98P ONLY)

mat'l. code		surface		tolerance		projection		product family	
-		-		ASME_Y14.5				PCI_EXPRESS	
lfr		ecn no		dr		date		title	
								PCI_EXPRESS_CARD_EDGE_GEN3	
								TH_ASS'Y	
								dwg no	
								sheet 6 of 7	
								size	
								A4	
								type	
								CUSTOMER Drawing	
sheet index		revision		H					

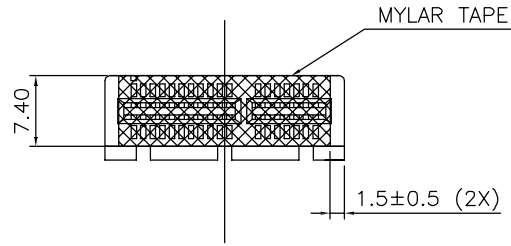

POSTION OF MYLAR



POSTION OF CAP (10×10)



POSTION OF 30MM CAP(30X12)

mat'l. code		-		surface	-	tolerance	ASME_Y14.5	projection	product family	PCI_EXPRESS	
lfr	ecn no	dr	date	tolerances unless otherwise specified				MM	title		
				angles	±2'	linear	.02±0.30 .00±0.20 .000±0.10	MM	PCI_EXPRESS_CARD_EDGE_GEN3 TH_ASS'Y		
				dr	ZHENHUA_LIU	2016-03-30		scale N/A	dwg no		sheet 7 of 7
				enfr	ZHENHUA_LIU	2016-03-30		Amphenol FCI	10108777		size
				chr	STONE_LI	2016-03-30			CUSTOMER Drawing		A4
				appd	PM_ZHENG	2016-03-30					
sheet index	revision sheet	H									