

## Description

Miniaturised single pole press-to-reset cycling trip free thermal circuit breaker designed for automotive fuse block installation.

Extends the benefits of circuit breaker performance and convenience to applications which are cost critical. Colour-coded housing caps or manual release buttons available.

Version 1616 is available especially for the automotive industry (current ratings correspond to those of blade fuses).

**US patent number:** US 6,590,489 B1 (1610-H2)

## Typical applications

Extra low voltage wiring systems on all types of vehicles and marine craft.

## Ordering information

Type No.	
1610	single pole automotive circuit breaker
<b>Voltage rating</b>	
21	DC 24 V, with reset button
H2	DC 24 V, with reset button and manual release facility
92	DC 12 V, autoreset (type I to SAE J 553)
<b>Current ratings</b>	
	5 6 8 10 15 20 25 30 A
1610 - 21 - 8 A ordering example	

Please be informed that we have minimum ordering quantities to be observed.

## Preferred types

Preferred types	Standard current ratings (A)							
	5	6	8	10	15	20	25	30
1610-21-	x	x	x	x	x	x	x	x

## Current ratings, typical voltage drop values and colour coding

Current rating (A)	Voltage drop (mV)	Actuator colour manual release (1610-H2) or housing cap colour (1610-21)
5	< 150	light-brown
6	< 150	green
8	< 150	golden yellow
10	< 150	red
15	< 150	blue
20	< 150	yellow
25	< 150	pearl
30	< 150	light-green

## Approvals

Authority	Standard	Rated voltage	Current ratings
UL	UL 1500 Ignition Protected	DC 24 V	5 A...30 A



1610-21

1610-H2

1610-92

## Technical data

For further details please see: [www.e-t-a.de/ti\\_e](http://www.e-t-a.de/ti_e)

Voltage rating	1610-92: DC 12 V 1610-21/1610-H2: DC 12 V / DC 24 V
Max. voltage rating	1610-92 DC 14,5 V 1610-21/1610-H2 DC 32 V
Current ratings	5...30 A
Service short-circuit breaking capacity	300 operations at ≤ 50 A
Reset period for 1610-92 (at 23 °C)	≤ 15 s
Ambient temperature	-40...+85 °C (-40...+185 °F)
Degree of protection (IEC 60529/DIN 40050)	operating area IP30 (-21/-H2) operating area IP54 (-92) terminal area IP00
Ultimate short-circuit breaking capacity	≥ 3 break operations at 150 A, or ≥ 1 break operation at 2,000 A
Vibration (with mounting socket 12)	10 g (57-500 Hz) ± 0.38 mm (10-57 Hz) to IEC 60068-2-6, test Fc 10 frequency cycles/axis
Shock (with mounting socket 12)	50 g (11 ms) to IEC 60068-2-27, test Ea
Corrosion	96 hours at 5 % salt mist, to IEC 60068-2-11, test Ka
Humidity	240 hours at 95 % RH, to IEC 60068-2-78, test Cab
Mass	approx. 5 g

### Caution:

It is good practice to switch off the vehicle's ignition system before re-setting the circuit breaker.

Free travel of the reset button must be ensured! Please ensure to push in the actuator smoothly and completely.

**Dimensions**

**1610-21**



**1610-H2**



**1610-92**



**Internal connection diagrams**

**1610-21**



**1610-H2**

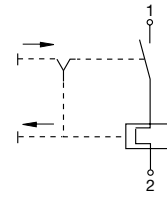

**1610-92**

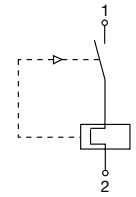

**Typical time/current characteristic curve**

**5...30 A**

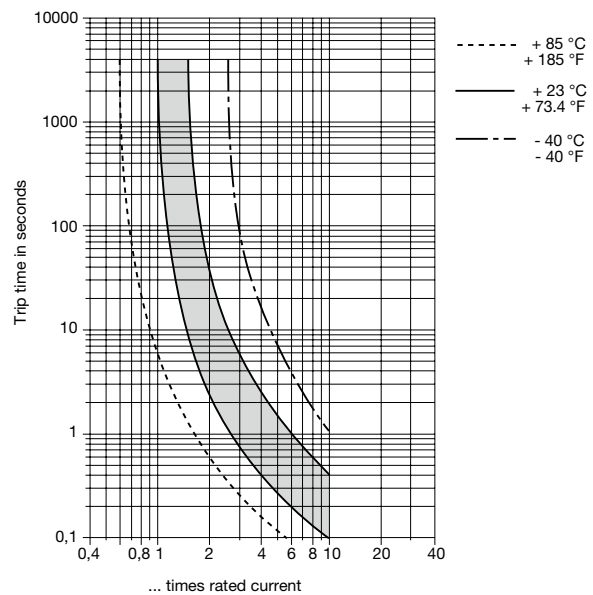

The time/current characteristic curve depends on the ambient temperature prevailing. In order to eliminate nuisance tripping, please multiply the circuit breaker current ratings by the derating factor shown below. See also section Technical information.

Ambient temperature °F	-40	-22	-4	+14	+32	+50
Ambient temperature °C	-40	-30	-20	-10	0	+10
Derating factor	0.73	0.78	0.82	0.86	0.91	0.95
Ambient temperature °F	+73.4	+104	+122	+140	+158	+185
Ambient temperature °C	+23	+40	+50	+60	+70	+85
Derating factor	1	1.09	1.16	1.25	1.33	1.43

This is a metric design and millimeter dimensions take precedence (mm/inch)

## Accessories

### Socket 12-P10



### Socket 12-J20

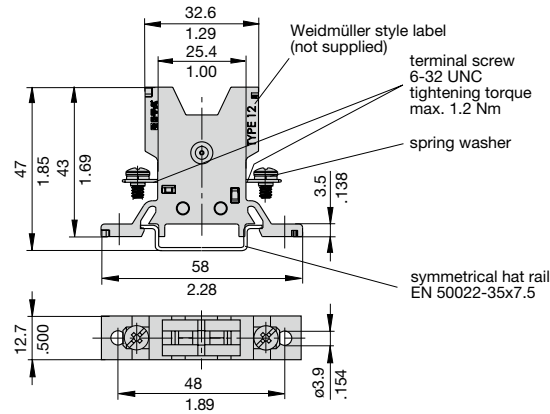

### Socket 12-A10



### Dimensions for surface mounting

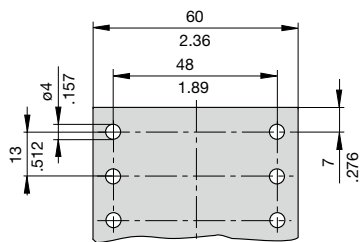

### Other sockets available to special order

Labels: Weidmüller, D-33102 Paderborn

## Ordering information Mounting socket 12

### Type No.

12 Mounting socket

### Terminal design

P10 blade terminals A 6.3-0.8 (QC .250)

J20 screw terminals 6-32 UNC

A10 1 blade terminal A6.3-0.8 (QC .250) / 1 screw terminal 6-32 UNC

### Version

(blank) single socket

20 two-way

30 three-way

40 four-way

60 six-way

12 - P10 - 20 ordering example

Labels: Weidmüller, D-33102 Paderborn

## Accessories for mounting socket 12

### Connector bus links -P10

X 210 588 01/ 1.5 mm<sup>2</sup> (AWG 16), brown (up to 13 A max. load)

X 210 588 02/ 2.5 mm<sup>2</sup> (AWG 14), black (up to 20 A max. load)

X 210 588 03/ 2.5 mm<sup>2</sup> (AWG 14), red (up to 20 A max. load)

X 210 588 04/ 2.5 mm<sup>2</sup> (AWG 14), blue (up to 20 A max. load)

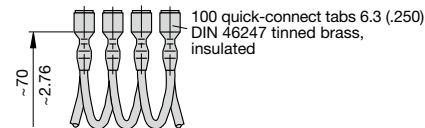

### Bus bar (supplied as a complete package)

(up to 100 A max. load)

X 211 157 01 with terminal

X 211 157 02 without terminal

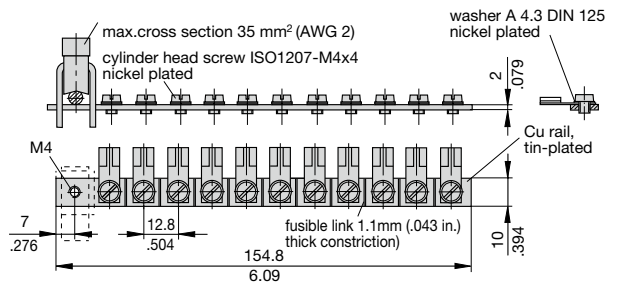

This is a metric design and millimeter dimensions take precedence ( $\frac{\text{mm}}{\text{inch}}$ )

All dimensions without tolerances are for reference only. In the interest of improved design, performance and cost effectiveness the right to make changes in these specifications without notice is reserved. Product markings may not be exactly as the ordering codes. Errors and omissions excepted.

1