

THERMO 2 click™

2. Soldering the headers

Before using your click™ board, make sure to solder 1x8 male headers to both left and right side of the board. Two 1x8 male headers are included with the board in the package.

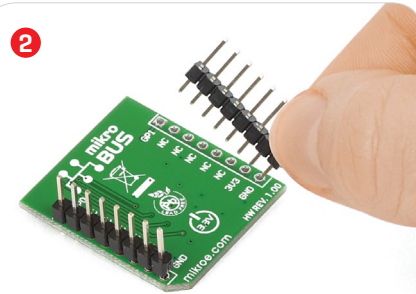
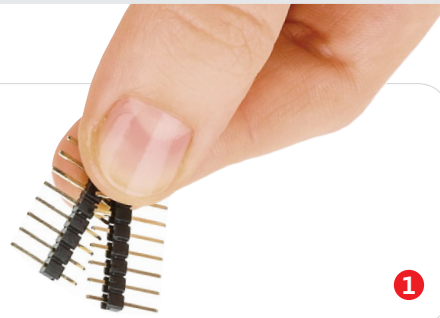

Turn the board upside down so that the bottom side is facing you upwards. Place shorter pins of the header into the appropriate soldering pads.

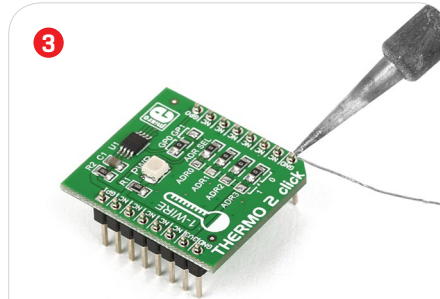

Turn the board upward again. Make sure to align the headers so that they are perpendicular to the board, then solder the pins carefully.

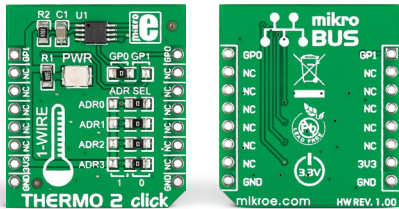

1. Introduction

Thermo 2 click™ carries DS18B25, a programmable resolution digital thermometer IC with a unique 64-bit address. The board communicates with the target microcontroller through a 1-wire interface. Using the onboard jumper you can select between two outputs: GP1 (default mikroBUS™ AN pin), and GPO (default PWM pin). The board is designed to use a 3.3 V power supply only.

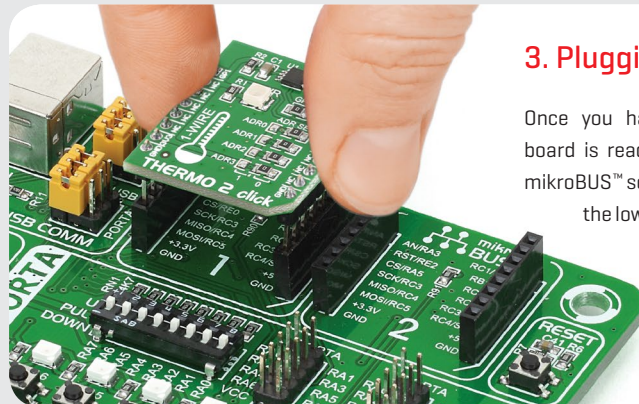

3. Plugging the board in

Once you have soldered the headers your board is ready to be placed into the desired mikroBUS™ socket. Make sure to align the cut in the lower-right part of the board with the markings on the silkscreen at the mikroBUS™ socket. If all the pins are aligned correctly, push the board all the way into the socket.

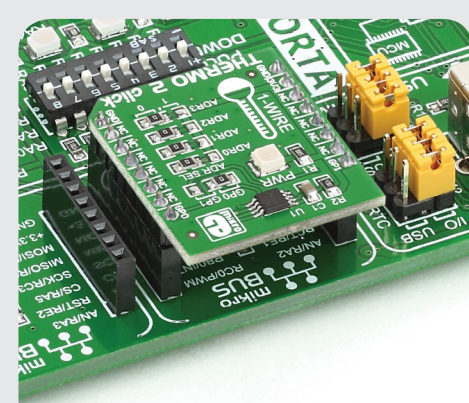

4. Essential features

The sensor aboard Thermo 2 click™ measures temperature within a range from -10°C to 85°C with $\pm 0.5^{\circ}\text{C}$ accuracy. You can specify the resolution of the measurements, from 9 to 12-bit, depending on the application. Because each DS18B25 has a unique 64-bit serial code, many of them can function on the same 1-wire bus. The 4-bit location address let's you set up a unique ID for up to 16 sensors that operate on a single 1-Wire bus.

click™
BOARD
www.mikroe.com



THERMO 2 click™ manual
ver 1.00



5. Schematic

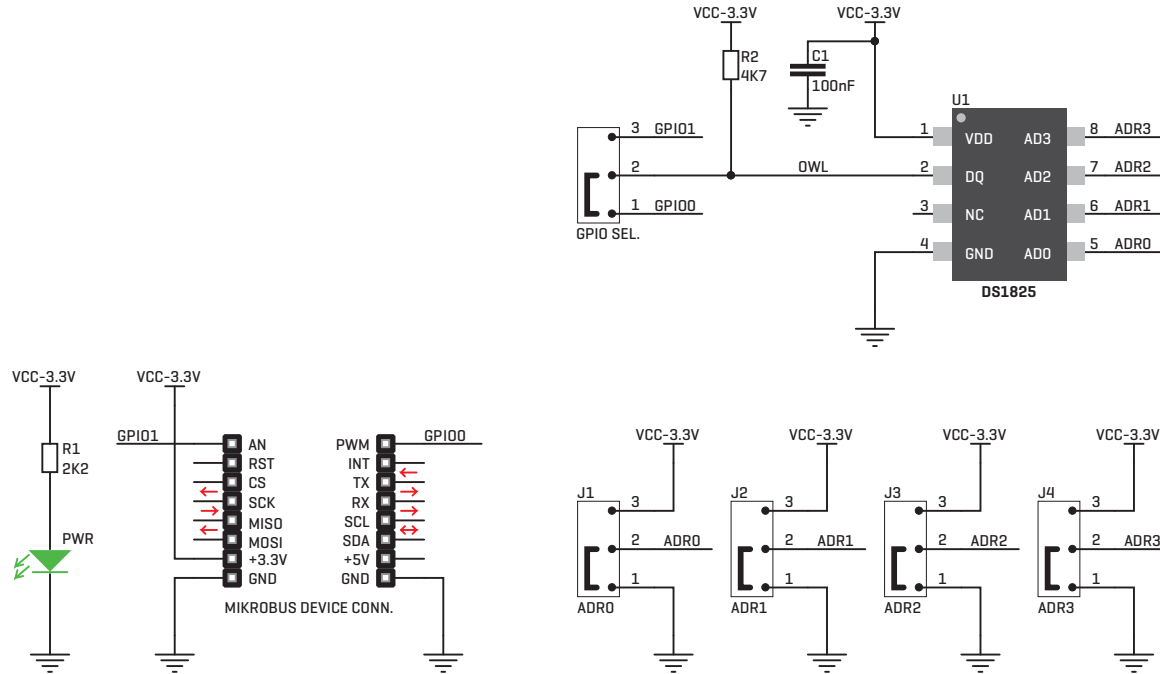

6. Dimensions

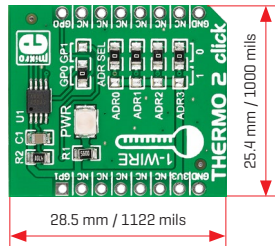

	mm	mils
LENGTH	28.5	1122
WIDTH	25.4	1000
HEIGHT*	3.2	126

* without headers

7. Onboard jumpers



The board features a set of four onboard jumpers [zero ohm resistors] for specifying a unique address for the sensor. A separate jumper lets you select the sensor's output between GP01 and GPO pins.

8. Code examples

Once you have done all the necessary preparations, it's time to get your click™ board up and running. We have provided examples for mikroC™, mikroBasic™ and mikroPascal™ compilers on our **Libstock** website. Just download them and you are ready to start.



9. Support

MikroElektronika offers **free tech support** [www.mikroe.com/support] until the end of the product's lifetime, so if something goes wrong, we're ready and willing to help!



10. Disclaimer

MikroElektronika assumes no responsibility or liability for any errors or inaccuracies that may appear in the present document. Specification and information contained in the present schematic are subject to change at any time without notice.

Copyright © 2015 MikroElektronika.
All rights reserved.