





Messrs.					
Product Specification	Model:	MTF-T057AMSLP-V4	Rev. No.	Issued Date.	Page.
			B	March.13, 09	1 / 33

LIQUID CRYSTAL DISPLAY MODULE
MODEL: MTF-T057AMSLP-V4
Customer's No.:

Acceptance

Microtips Technology Inc.
12F. No.31 Lane 169, Kang Ning St.,
Hsi-Chih, Taipei Hsien, Taiwan
FAX: 886-2-26958625

Approved and Checked by

Approved by	Checked by		Made by
			



Microtips Technology Inc.

Messrs.					
Product Specification	Model:	MTF-T057AMSLP-V4	Rev. No.	Issued Date.	Page.
			B	March.13, 09	2 / 33

Revise Records

Rev.	Date	Contents	Written	Approved
A	2008/06/18	Specification released	Sherry Chen	Steele Lee
B	2009/03/13	See Note2.	Jill Hsu	Steele Lee

Special Notes

Note1.	The LCD module is compliant with RoHS.
Note2.	Modified power circuit to eliminate flicker. (IC: AIC1896)
Note3.	
Note4.	
Note5.	



Messrs.					
Product Specification	Model:	MTF-T057AMSLP-V4	Rev. No.	Issued Date.	Page.
			<i>B</i>	<i>March.13, 09</i>	<i>3 / 33</i>

Contents

1. GENERAL DESCRIPTION AND FEATURES	5
1.1 Features.....	5
1.2 General Specifications.....	5
2. INPUT TERMINAL PIN ASSIGNMENT	6
2.1 Pin Assignment.....	6
2.2 Back-light Unit (BLU).....	7
2.3 Touch Panel Pin Assignment	7
3. BLOCK DIAGRAM	8
4. OPTICAL CHARACTERISTICS	9
5. ABSOLUTE MAXIMUM RATINGS	12
5.1 Absolute Ratings of Environment	12
5.2 Electrical Absolute Maximum Rating	13
6. ELECTRICAL CHARACTERISTICS	14
6.1 DC Electrical Characteristics.....	14
6.2 AC Timing Characteristic of The LCD	15
7. BACKLIGHT SPECIFICATIONS	18
8. DISPLAYED COLOR AND INPUT DATA	19
9. INSPECTION PROVISION	20
9.1 Purpose	20
9.2 Applicable Scope.....	20
9.3 Technical Terms.....	20
9.4 Outgoing Inspection	20
9.5 Specification for qualitycheck.....	22
10. RELIABILITY CONDITION	28
10.1 LCM Reliability Test	28
10.2 Touch panel Reliability.....	28
11. PRECAUTIONS	29
11.1 Operation	29
11.2 Safety.....	29
11.3 Handling	29
11.4 Static electricity	31
11.5 Storage.....	31



Messrs.					
Product Specification	Model:	MTF-T057AMSLP-V4	Rev. No.	Issued Date.	Page.
			<i>B</i>	<i>March.13, 09</i>	<i>4 / 33</i>

11.6	Cleaning.....	31
11.7	Waste.....	31
12.	WARRANTY	32
13.	DIMENSIONAL OUTLINES	32



Messrs.					
Product Specification	Model:	MTF-T057AMSLP-V4	Rev. No.	Issued Date.	Page.
			<i>B</i>	<i>March.13, 09</i>	<i>5 / 33</i>

1. GENERAL DESCRIPTION AND FEATURES

MTF-T057AMSLP-V4 is a TM (Transmissive) type color active matrix TFT (Thin Film Transistor) liquid crystal display (LCD) that uses amorphous silicon TFT as a switching device. This model is composed of a TFT-LCD module, a driver circuit and a back-light unit. The resolution of a 5.7" contains 320RGB×240 dots and can display up to 262K colors. The following table described the features of MTF-T057AMSLP-V4.

1.1 Features

- Transmissive type with LED back-light.
- TN (Twisted Nematic) mode.
- Digital RGB (6bits/color) Data Transfer
- Backlight-driving DC/AC inverter is not built in this module.
- clock setting, like sharp compatible (data will be stable on the falling edge)

1.2 General Specifications

Item	Specification	Unit
Screen Size	5.7 inches diagonal	--
Display Resolution	320 x RGB x 240	Dot
Pixel Pitch	0.36 (H) ×0.36 (V)	mm
Active Area	115.2 (W) x 86.4 (H)	mm
Outline Dimension	144.0 (W) x 104.6 (H) x 11.0 (T), without FPCB tail and connector cable	mm
Weight	175g (MTF-T057AMSLN-V4)	--
	212g (MTF-T057AMSLP-V4)	
Display Mode	Normally White/Transmissive/Wide view	--
Pixel Arrangement	RGB-Vertical Stripe	--
Surface Treatment	Anti-Glare(3H)	--
Viewing Direction	6 o'clock	--
Input Interface	Digital RGB (6bits/color) Data Transfer	--
TFT Driver	Source: Himax HX8218A, Gate: Himax HX8615A	--
Color Garmut	NTSC 58%	--

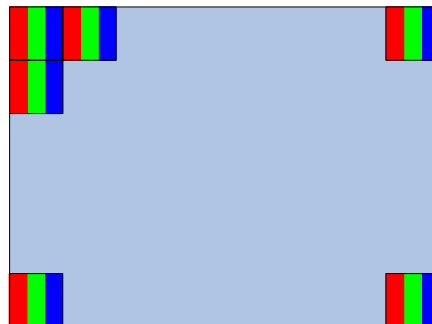

Microtips Technology Inc.

Messrs.					
Product Specification	Model:	MTF-T057AMSLP-V4	Rev. No.	Issued Date.	Page.
			<i>B</i>	<i>March.13, 09</i>	<i>6 / 33</i>

2. INPUT TERMINAL PIN ASSIGNMENT

2.1 Pin Assignment

Pin No.	Symbol	I/O	Function	Remark
1	DGND	--	GND	--
2	DCLK	I	Clock signal for sampling each data signal	--
3	Hsync	I	Horizontal synchronous signal (Negative)	--
4	Vsync	I	Vertical synchronous signal (Negative)	--
5	GND	I	GND	--
6	R0	I	RED data signal (LSB)	--
7	R1	I	RED data signal	--
8	R2	I	RED data signal	--
9	R3	I	RED data signal	--
10	R4	I	RED data signal	--
11	R5	I	RED data signal (MSB)	--
12	GND	--	GND	--
13	G0	I	GREEN data signal (LSB)	--
14	G1	I	GREEN data signal	--
15	G2	I	GREEN data signal	--
16	G3	I	GREEN data signal	--
17	G4	I	GREEN data signal	--
18	G5	I	GREEN data signal (MSB)	--
19	GND	--	GND	--
20	B0	I	BLUE data signal(LSB)	--
21	B1	I	BLUE data signal	--
22	B2	I	BLUE data signal	--
23	B3	I	BLUE data signal	--
24	B4	I	BLUE data signal	--
25	B5	I	BLUE data signal(MSB)	--
26	GND	--	GND	--
27	DEN	I	Signal to settle the horizontal display position (Positive)	Note5-1
28	V _{DD}	--	+3.3V power supply	--
29	V _{DD}	--	+3.3V power supply	--



Messrs.					
Product Specification	Model:	MTF-T057AMSLP-V4	Rev. No.	Issued Date.	Page.
			<i>B</i>	<i>March.13, 09</i>	<i>7 / 33</i>

30	LRC	I	Horizontal display mode select signal L: Normal H: Left / Right reverse mode	Note5-2
31	UDC	I	Vertical display mode select signal H: Normal L: Up / Down reverse mode	Note5-3
32	NC	--	No Connection	--
33	GND	I	GND	--

Note5-1 The horizontal display start timing is settled in accordance with a rising timing of ENAB signal. In case ENAB is fixed "Low", the horizontal start timing is determined. Don't keep ENAB "High" during operation.

Note5-2,3

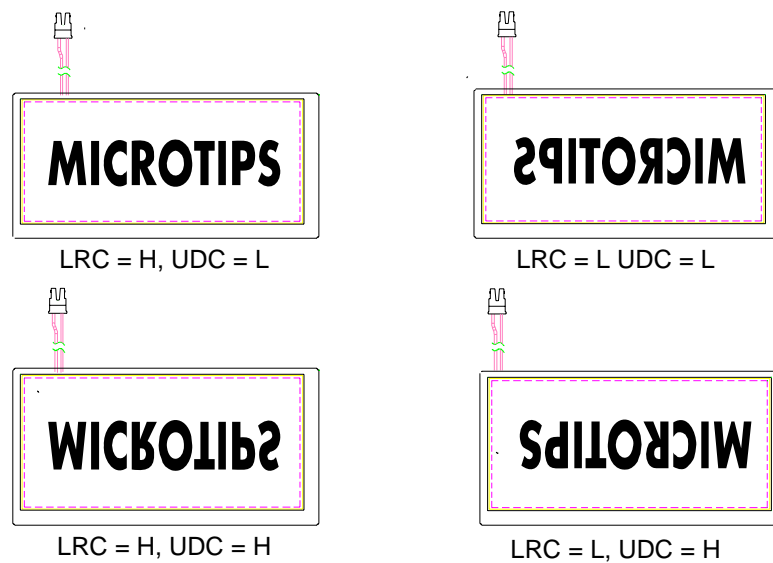

2.2 Back-light Unit (BLU)

Pin No.	Symbol	Function	Remark
1	LEDA	Power Supply for LED backlight	--
2	LEDK	GND for LED backlight	--

2.3 Touch Panel Pin Assignment

Pin No.	Designation
1	YU
2	XR
3	YD
4	XL



Microtips Technology Inc.

Messrs.					
Product Specification	Model:	MTF-T057AMSLP-V4	Rev. No.	Issued Date.	Page.
			<i>B</i>	<i>March.13, 09</i>	<i>8 / 33</i>

3. BLOCK DIAGRAM

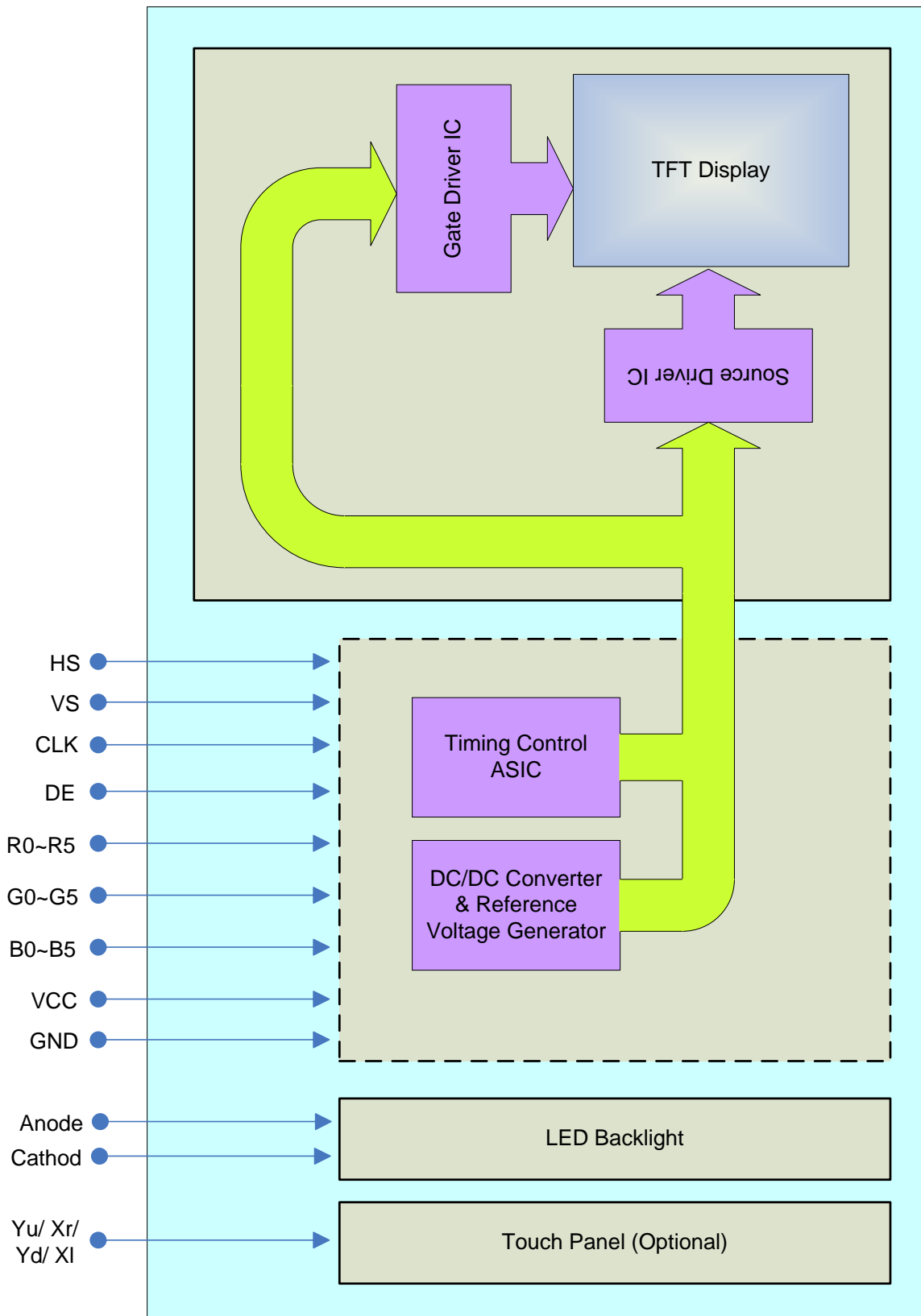

Messrs.					
Product Specification	Model:	MTF-T057AMSLP-V4	Rev. No.	Issued Date.	Page.
			<i>B</i>	<i>March.13, 09</i>	<i>9 / 33</i>

4. OPTICAL CHARACTERISTICS

The following items are measured under stable conditions. The optical characteristics should be measured in a dark room or equivalent state with the methods shown in Note (1).

Measuring equipment: LCD-5000, BM-5A, BM-7, PR-650, EZ-Contrast

($T_a=25^{\circ}\text{C}$, $I_F=300\text{mA}$)

Item		Symbol	Condition	Min	Type	Max	Unit	Note
Brightness	MTF-T057AMSLN-V4	Br	300mA/6.6V	500	550	--	cd/m^2	Note 1
	MTF-T057AMSLP-V4			400	440	--	cd/m^2	
Response time		T_r	$\theta=0^{\circ}$	--	15	20	ms	Note 2
		T_f		--	35	50	ms	
Contrast ratio		CR	At optimized viewing angle	150	250	--	--	Note 3
Color Chromaticity	Red	R_x	$\theta=0^{\circ}$ Normal Viewing Angle	0.610	0.640	0.670	--	--
		R_y		0.314	0.344	0.374		
	Green	G_x		0.268	0.298	0.328	--	
		G_y		0.553	0.583	0.613		
	Blue	B_x		0.107	0.137	0.167	--	
		B_y		0.139	0.159	0.179		
	White	W_x		0.282	0.312	0.342	--	
		W_y		0.319	0.349	0.379		
Viewing Angle (6H)	Hor.	θ_R	$CR \geq 10$	--	65	--	Degree	Note 4
		θ_L		--	65	--		
	Ver.	θ_B		--	50	--		
		θ_F		--	65	--		
LED Life time	25°C	LL	$I_F=300\text{mA}$ $V_F=6.6\text{V}$	--	50k	--	Hours	Note 5

Note 1: Test Equipment Setup

After stabilizing and leaving the panel alone at a given temperature for 30 min., the measurement should be executed. Measurement should be executed in a stable, windless, and dark room, 30 min. after turning the back light on. This should be measured in the center of screen.

Back-Light current: 300mA

- Environment condition:
1. $T_a=25 \pm 2^{\circ}\text{C}$
 2. Illuminations ≤ 1 lux



Microtips Technology Inc.

Messrs.					
Product Specification	Model:	MTF-T057AMSLP-V4	Rev. No.	Issued Date.	Page.
			<i>B</i>	<i>March.13, 09</i>	<i>10 / 33</i>

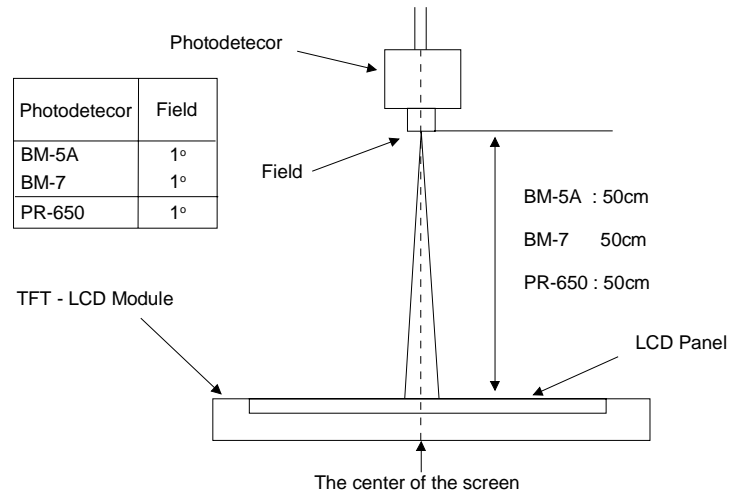

Note 2: Definition of response time: Tr and Tf

The response time is defined as the following figure and shall be measured by switching the input signal for “black” and “white”.

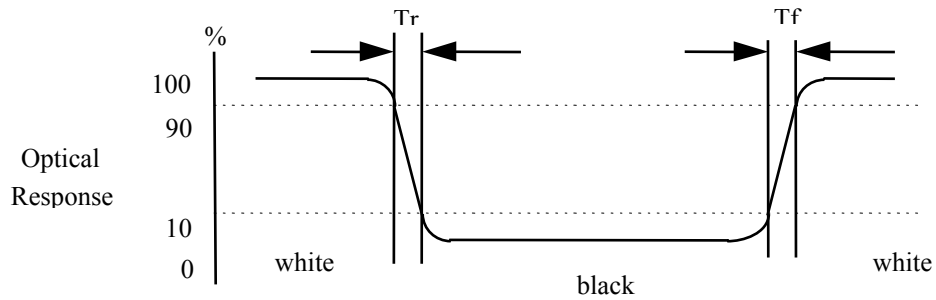

Note 3: Definition of contrast ratio:

$$\text{Contrast Ratio (CR)} = \frac{\text{Brightness measured when LCD is at "white state"}}{\text{Brightness measured when LCD is at "black state"}}$$



Microtips Technology Inc.

Messrs.					
Product Specification	Model:	MTF-T057AMSLP-V4	Rev. No.	Issued Date.	Page.
			<i>B</i>	<i>March.13, 09</i>	<i>11 / 33</i>

Note 4: Measured at the center area of the panel when all the input terminals of LCD panel are electrically opened.

View Angle

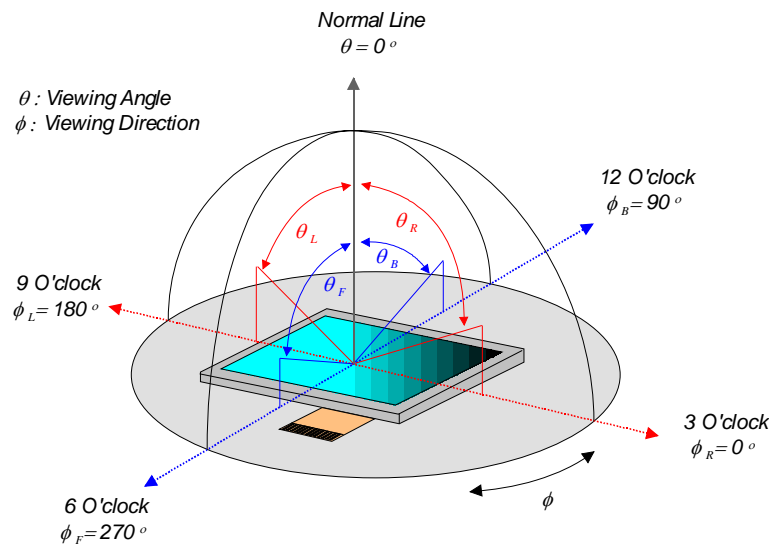

Note 5: This is the reference value. The white-LED life time is defined as a time when brightness not to become under 50% of the original value (at $T_a=25^\circ\text{C}$)



Microtips Technology Inc.

Messrs.					
Product Specification	Model:	MTF-T057AMSLP-V4	Rev. No.	Issued Date.	Page.
			<i>B</i>	<i>March.13, 09</i>	<i>12 / 33</i>

5. ABSOLUTE MAXIMUM RATINGS

5.1 Absolute Ratings of Environment

If the operating condition exceeds the following absolute maximum ratings, the TFT LCD module may be damaged permanently.

($T_a=25^\circ\text{C}$, $V_{SS}=\text{GND}=0$)

Item	Symbol	Min.	Max.	Unit	Note
Storage temperature	T_{STG}	-30	80	$^\circ\text{C}$	(1)
Operating temperature (Ambient temperature)	T_{OPR}	-20	70	$^\circ\text{C}$	(1), (2)

Note (1) 95 % RH Max. ($40^\circ\text{C} \geq T_a$)

Maximum wet-bulb temperature at 39°C or less. ($T_a > 40^\circ\text{C}$) No condensation.

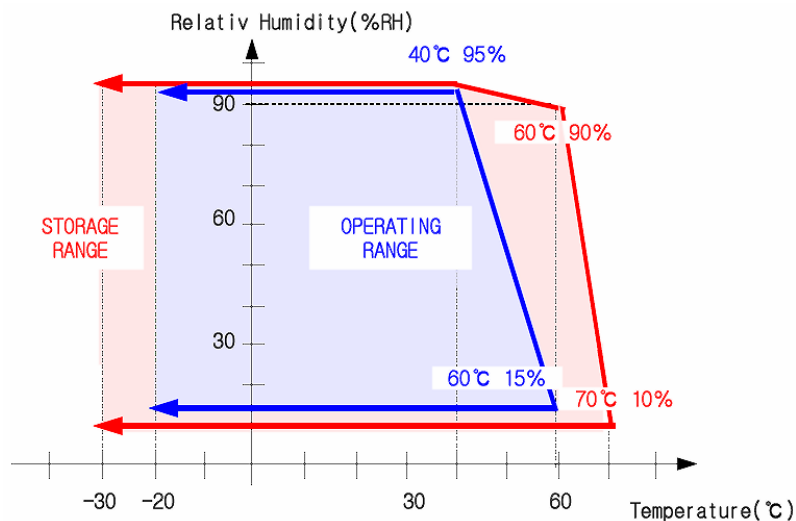

- (2) In case of below 0° , the response time of liquid crystal (LC) becomes slower and the color of panel becomes darker than normal one. Level of retardation depends on temperature, because of LC's character



Microtips Technology Inc.

Messrs.					
Product Specification	Model:	MTF-T057AMSLP-V4	Rev. No.	Issued Date.	Page.
			B	March.13, 09	13 / 33

5.2 Electrical Absolute Maximum Rating

($T_a=25^{\circ}\text{C}$, $V_{SS}=\text{GND}=0$)

Parameter	Symbol	Min.	Typ.	Max.	Unit	Remark
Power Supply Voltage	V_{DD}	-0.3	--	+7.0	V	Note 1
Permissible input ripple voltage	V_{RF}	--	--	100	mVp-p	$V_{DD}=+3.3\text{V}$
Input voltage (Low)	V_{IL}	0	--	$0.3 V_{DD}$	V	Note 2
Input voltage (High)	V_{IH}	$0.7 V_{DD}$	--	+5.5	V	
Input current (Low)	I_{OL1}	--	--	10	μA	$V_I=0\text{V}$, Note 2
Input current (High)	I_{OH1}	--	--	10	μA	$V_I=3.3\sim 5.0\text{V}$, Note 3
	I_{OH2}	--	--	100	μA	$V_I=3.3\sim 5.0\text{V}$, Note 4

Note1:

V_{DD} -turn-on conditions

$$0 < t_1 \leq 20\text{ms}$$

$$0 < t_2 \leq 50\text{ms}$$

$$0 < t_3 \leq 1\text{s}$$

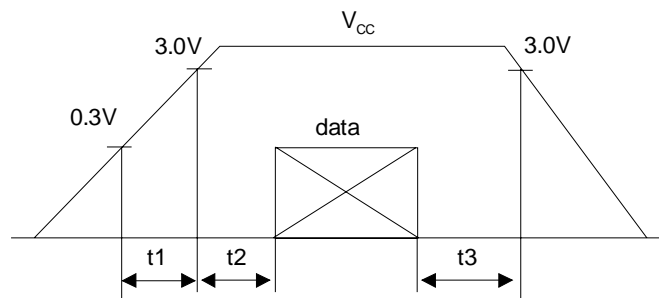

V_{DD} -dip conditions

V_{DD} -dip conditions should also follow the V_{DD} -turn-on conditions

$$T_d \leq 20\text{ms}$$

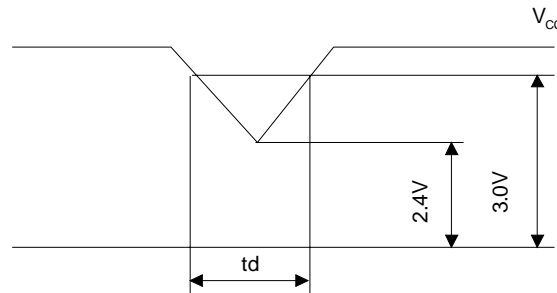

Note2: CLK, R0~R5, G0~G5, B0~B5, Hsync, Vsync, DE, R/L, U/D

Note3: CLK, R0~R5, G0~G5, B0~B5, Hsync, Vsync, R/L, U/D

Note4: DE



Microtips Technology Inc.

Messrs.					
Product Specification	Model:	MTF-T057AMSLP-V4	Rev. No.	Issued Date.	Page.
			<i>B</i>	<i>March.13, 09</i>	<i>14 / 33</i>

6. ELECTRICAL CHARACTERISTICS

6.1 DC Electrical Characteristics

(Ta=25±2°C, V_{SS}=GND=0)

Item	Symbol	Min.	Typ.	Max.	Unit	Remark	
Supply Voltage	V _{DD}	3.0	3.3	3.6	V	--	
Supply Current	I _{DD}	40	50	60	mA	Note 2	
Input Voltage for logic	L Level	V _{IH}	0.7 V _{DD}	--	V _{DD}	V	Note 1
	H Level	V _{IL}	0	--	0.3 V _{DD}	V	--

Note1: Hsync, Vsync, DEN, DCLK, R0~R5, G0~G5, B0~B5

Note2: fV =60Hz , Ta=25°C , Display pattern : All Black



Microtips Technology Inc.

Messrs.					
Product Specification	Model:	MTF-T057AMSLP-V4	Rev. No.	Issued Date.	Page.
			<i>B</i>	<i>March.13, 09</i>	<i>15 / 33</i>

6.2 AC Timing Characteristic of The LCD

6.2.1 Timing Condition

Signal	Parameter	Symbol	Min.	Typ.	Max.	Unit.	Remark	
DCLK	DCLK period	T _{OSC}	--	156	--	ns	--	
	Frequency	F _{OSC}	--	6.4	--	MHz	--	
	DCLK High plus width	T _{CH}	--	78	--	ns	--	
	DCLK Low plus width	T _{CL}	--	78	--	ns	--	
RGB DATA	Data setup time	T _{SU}	12	--	--	ns	--	
	Data hold time	T _{HD}	12	--	--	ns	--	
Hsync	Hsync period	T _H	--	408	--	T _{OSC}	--	
	Hsync pulse width	T _{HS}	5	30	--	T _{OSC}	--	
	Back-Porch	T _{HB}	--	38	--	T _{OSC}	--	
	Front-Porch	T _{HF}	--	20	--	T _{OSC}	--	
	Hsync rising time	T _{Cf}	--	--	700	ns	--	
	Hsync falling time	T _{Cf}	--	--	300	ns	--	
Vsync	Vsync period	NTSC	--	--	262.5	--	T _H	--
		PAL	--	--	312.5	--	T _H	--
	Vsync pulse width	T _{VS}	1	3	5	T _H	--	
	Back-Porch	NTSC	T _{VB}	--	15	--	T _H	--
		PAL		--	23	--	T _H	--
	Display Period	T _{VD}	--	240	--	T _H	--	
	Front Porch	NTSC	T _{VF}	--	4.5	--	T _H	--
		PAL		--	46.5	--	T _H	--
	Vsync rising time	T _{Vr}	--	--	700	ns	--	
	Vsync falling time	T _{Vf}	--	--	1.5	μs	--	
Vsync falling to Hsync rising time for odd field	T _{HVO}	1	--	--	T _{OSC}	--		
Vsync falling to Hsync falling time for even field	T _{HVE}	1	--	--	T _{OSC}	--		
DEN	Vsync-DEN time	NTSC	T _{VSE}	--	18	--	T _H	--
		PAL	T _{VSE}	--	26	--	T _H	--
	Hsync-DEN time	T _{HE}	36	68	88	T _{OSC}	--	
	DEN plus width	T _{EP}	--	320	--	T _{OSC}	--	

Note: If DEN is fixed to low, the SYNC mode is used. Otherwise DE mode is used. When SYNC mode is used, 1st data start from 68th CLK after Hsync falling



Messrs.

Product Specification	Model: MTF-T057AMSLP-V4	Rev. No.	Issued Date.	Page.
		B	March.13, 09	16 / 33

6.2.2 Horizontal Display Timing

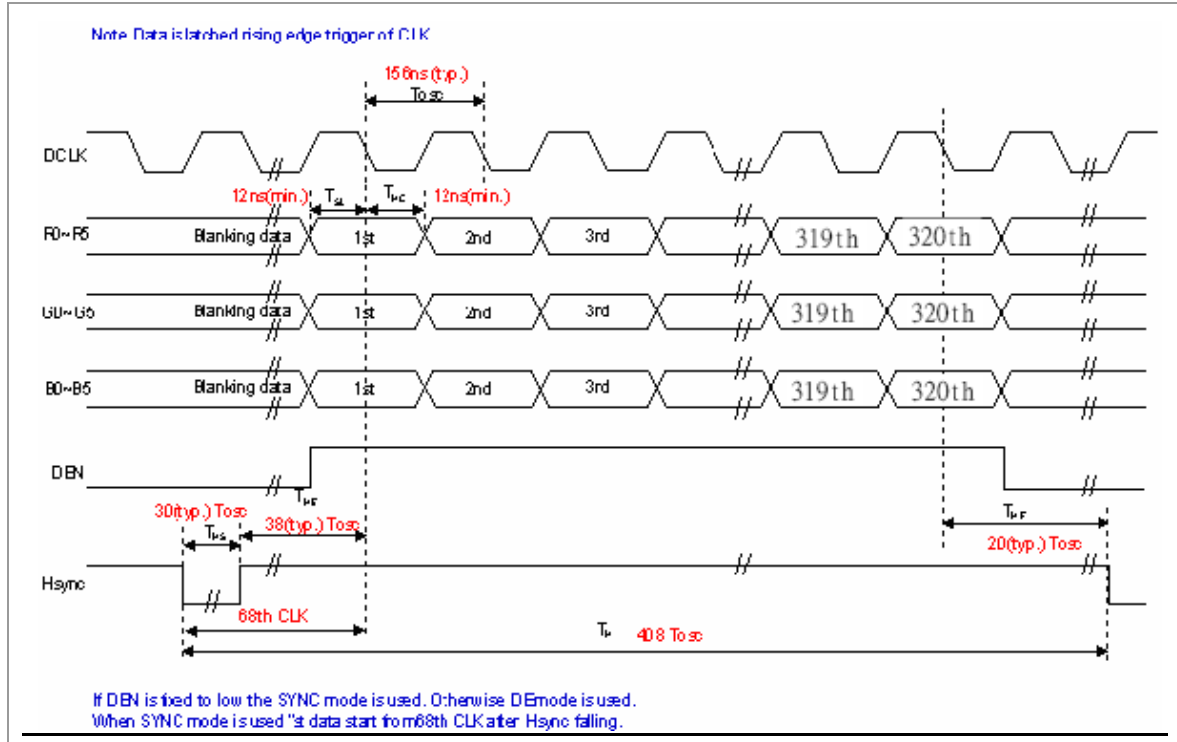

6.2.3 Vertical Display Timing

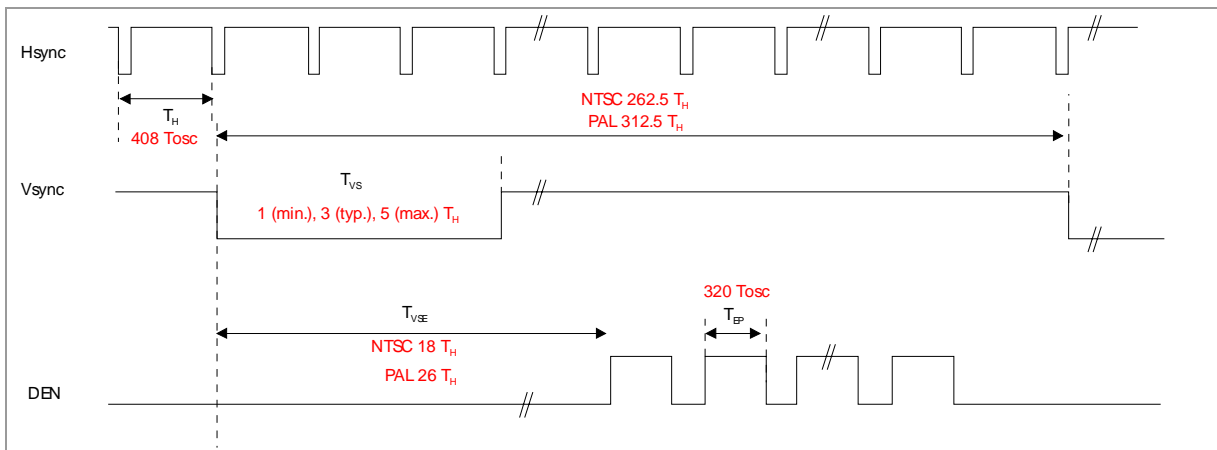

Microtips Technology Inc.

Messrs.					
Product Specification	Model:	MTF-T057AMSLP-V4	Rev. No.	Issued Date.	Page.
			<i>B</i>	<i>March.13, 09</i>	<i>17 / 33</i>

6.2.4 Hsync and Vsync Timing

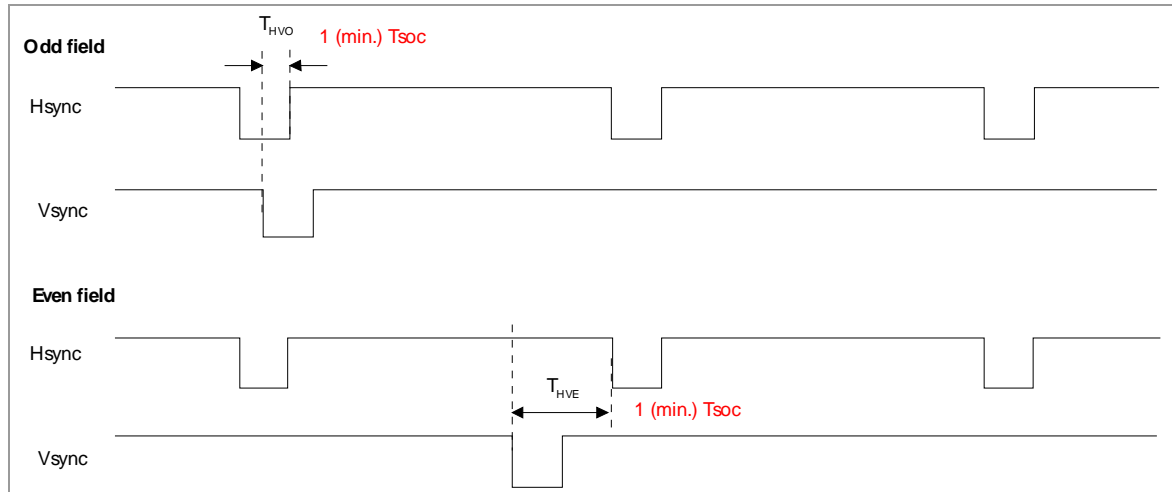

Messrs.					
Product Specification	Model:	MTF-T057AMSLP-V4	Rev. No.	Issued Date.	Page.
			<i>B</i>	<i>March.13, 09</i>	<i>18 / 33</i>

7. BACKLIGHT SPECIFICATIONS

7.1 Absolute Maximum Ratings

Ta=25°C

Item	Symbol	Maximum rating	Unit	Note
Peak Forward Current	I _{FM}	450	mA	(1)
Reverse Voltage	V _R	10	V	--
Power Dissipation	P _D	3300	mW	--
Operating Temperature	T _{OP}	-20~70	°C	--
Storage Temperature	T _{ST}	-30~80	°C	--

Note (1): Permanent damage to the device may occur if maximum values are exceeded or reverse voltage is loaded.

Functional operation should be restricted to the conditions described under normal operating conditions.

7.2 Electrical/Operating Characteristics

Ta = 25°C

Parameter	Symbol	Min.	Typ.	Max.	Units	Test Condition
Forward Voltage	V _F	--	6.6	--	V	Ta=25°C IF=300mA
LED Current	I _F	--	300	--	mA	
Uniformity*	--	80	--	--	%	
Chromaticity Coordinates	X	0.26	0.29	0.32	--	
	Y	0.26	0.29	0.32	--	

*: Uniformity = (Min./Max.) x 100%

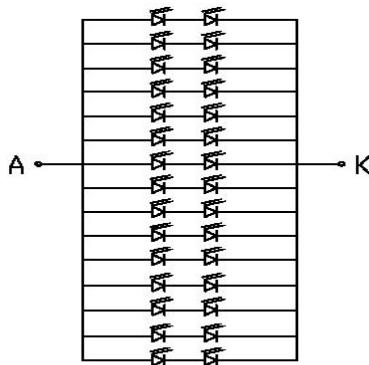

Microtips Technology Inc.

Messrs.					
Product Specification	Model:	MTF-T057AMSLP-V4	Rev. No.	Issued Date.	Page.
			<i>B</i>	<i>March.13, 09</i>	<i>19 / 33</i>

8. DISPLAYED COLOR AND INPUT DATA

	Color & Gray Scale	Data Signal																	
		R5	R4	R3	R2	R1	R0	G5	G4	G3	G2	G1	G0	B5	B4	B3	B2	B1	B0
Basic Color	Black	0	0	0	0	0	0	0	0	0	0	0	0	0	0	0	0	0	0
	Red(0)	1	1	1	1	1	1	0	0	0	0	0	0	0	0	0	0	0	0
	Green(0)	0	0	0	0	0	0	1	1	1	1	1	1	0	0	0	0	0	0
	Blue(0)	0	0	0	0	0	0	0	0	0	0	0	0	1	1	1	1	1	1
	Cyan	0	0	0	0	0	0	1	1	1	1	1	1	1	1	1	1	1	1
	Magenta	1	1	1	1	1	1	0	0	0	0	0	0	1	1	1	1	1	1
	Yellow	1	1	1	1	1	1	1	1	1	1	1	1	0	0	0	0	0	0
	White	1	1	1	1	1	1	1	1	1	1	1	1	1	1	1	1	1	1
Red	Black	0	0	0	0	0	0	0	0	0	0	0	0	0	0	0	0	0	0
	Red(62)	0	0	0	0	0	1	0	0	0	0	0	0	0	0	0	0	0	0
	Red(61)	0	0	0	0	1	0	0	0	0	0	0	0	0	0	0	0	0	0
	:	:	:	:	:	:	:	:	:	:	:	:	:	:	:	:	:	:	:
	Red(31)	0	1	1	1	1	1	0	0	0	0	0	0	0	0	0	0	0	0
	:	:	:	:	:	:	:	:	:	:	:	:	:	:	:	:	:	:	:
	Red(1)	1	1	1	1	1	0	0	0	0	0	0	0	0	0	0	0	0	0
	Red(0)	1	1	1	1	1	1	0	0	0	0	0	0	0	0	0	0	0	1
Green	Black	0	0	0	0	0	0	0	0	0	0	0	0	0	0	0	0	0	0
	Green(62)	0	0	0	0	0	0	0	0	0	0	0	1	0	0	0	0	0	0
	Green(61)	0	0	0	0	0	0	0	0	0	0	1	0	0	0	0	0	0	0
	:	:	:	:	:	:	:	:	:	:	:	:	:	:	:	:	:	:	:
	Green(31)	0	0	0	0	0	0	0	1	1	1	1	0	0	0	0	0	0	0
	:	:	:	:	:	:	:	:	:	:	:	:	:	:	:	:	:	:	:
	Green(1)	0	0	0	0	0	0	1	1	1	1	1	0	0	0	0	0	0	0
	Green(0)	0	0	0	0	0	0	1	1	1	1	1	1	0	0	0	0	0	0
Blue	Black	0	0	0	0	0	0	0	0	0	0	0	0	0	0	0	0	0	0
	Blue(62)	0	0	0	0	0	0	0	0	0	0	0	0	0	0	0	0	0	1
	Blue(61)	0	0	0	0	0	0	0	0	0	0	0	0	0	0	0	0	1	0
	:	:	:	:	:	:	:	:	:	:	:	:	:	:	:	:	:	:	:
	Blue(31)	0	0	0	0	0	0	0	0	0	0	0	0	0	1	1	1	1	1
	:	:	:	:	:	:	:	:	:	:	:	:	:	:	:	:	:	:	:
	Blue(1)	0	0	0	0	0	0	0	0	0	0	0	0	1	1	1	1	1	0
	Blue(0)	0	0	0	0	0	0	0	0	0	0	0	0	1	1	1	1	1	1



Messrs.					
Product Specification	Model:	MTF-T057AMSLP-V4	Rev. No.	Issued Date.	Page.
			<i>B</i>	<i>March.13, 09</i>	<i>20 / 33</i>

9. INSPECTION PROVISION

9.1 Purpose

The Microtips inspection provision provides outgoing inspection provision and its expected quality level based on our outgoing inspection of Microtips LCD produces.

9.2 Applicable Scope

The Microtip inspection provision is applicable to the arrangement in regard to outgoing inspection and quality assurance after outgoing.

9.3 Technical Terms

9.3.1 Microtips Technical Terms



9.4 Outgoing Inspection

9.4.1 Inspection Method

MIL-STD-105E Level II Regular inspection

9.4.2 Inspection Standard

	Item		AQL(%)	Remarks
Major Defect	Dots	Opens	0.4	faults which substantially lower the practicality and the initial purpose difficult to achieve
		Shorts		
	Erroneous operation			
	Solder appearance	Shorts		
		Loose		
	Cracks	Display surface cracks		



Microtips Technology Inc.

Messrs.					
Product Specification	Model:	MTF-T057AMSLP-V4	Rev. No.	Issued Date.	Page.
			<i>B</i>	<i>March.13, 09</i>	<i>21 / 33</i>

	Dimensions	External from Dimensions	0.4	
Minor Defect	Inside the glass	Black spots	0.65	faults which appear to pose almost no obstacle to the practicality, effective use, and operation.
	Polarizing plate	Scratches, foreign Matter, air bubbles, and peeling		
	Dots	Pinhole, deformation		
	Color tone	Color unevenness		
	Solder appearance	Cold solder Solder projections		

9.4.3 Inspection Provisions

*Viewing Area Definition

Fig. 1

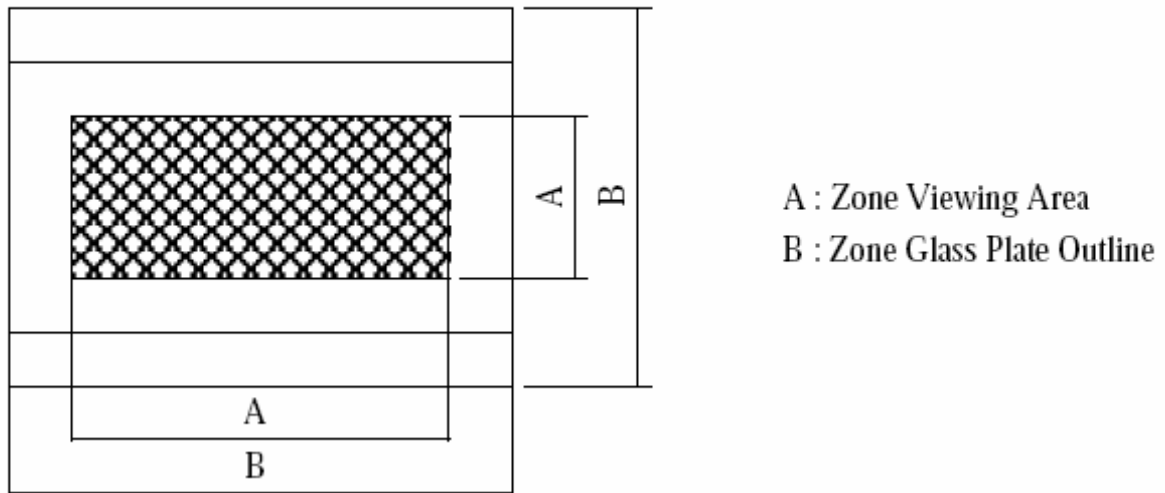

*Inspection place to be 500 to 1000 lux illuminance uniformly without glaring. The distance between luminous source (daylight fluorescent lamp and cool white fluorescent lamp) and sample to be 30 cm to 50 cm.



Microtips Technology Inc.

Messrs.					
Product Specification	Model:	MTF-T057AMSLP-V4	Rev. No.	Issued Date.	Page.
			<i>B</i>	<i>March.13, 09</i>	<i>22 / 33</i>

*Test and measurement are performed under the following conditions, unless otherwise specified.

Temperature 20 ± 15°C
Humidity 65 ± 20%R.H.
Pressure 860~1060hPa(mmbar)

In case of doubtful judgment, it is performed under the following conditions.

Temperature 20 ± 2°C
Humidity 65 ± 5%R.H.
Pressure 860~1060hPa(mmbar)

9.5 Specification for qualitycheck

9.5.1 Electrical characteristics :

NO.	Item	Criterion
1	Non operational	Fail
2	Miss operating	Fail
3	Contrast irregular	Fail
4	Response time	Within Specified value

9.5.2 Components soldering :

Should be no defective soldering such as shorting, loose terminal cold solder, peeling of printed circuit board pattern, improper mounting position, etc.

9.5.3 Inspection Standard for TFT panel

The environmental condition of inspection :

The environmental condition and visual inspection shall be conducted as below.

- (1) Ambient temperature : 25±5°C
- (2) Humidity : 25~75% RH
- (3) External appearance inspection shall be conducted by using a single 20W fluorescent lamp or equivalent illumination.
- (4) Visual inspection on the operation condition for cosmetic shall be conducted at the distance 30cm or more between the LCD panels and eyes of inspector.
The viewing angle shall be 90 degree to the front surface of display panel.
- (5) Ambient Illumination: 300~500 Lux for external appearance inspection.
- (6) Ambient Illumination: 100~200 Lux for light on inspection.



Messrs.					
Product Specification	Model:	MTF-T057AMSLP-V4	Rev. No.	Issued Date.	Page.
			<i>B</i>	<i>March.13, 09</i>	<i>23 / 33</i>

9.5.4 Inspection Criteria

(1) Definition of dot defect induced from the panel inside

- a) The definition of dot: The size of a defective dot over 1/2 of whole dot is regarded as one defective dot.
- b) Bright dot: Dots appear bright and unchanged in size in which LCD panel is displaying under black pattern.
- c) Dark dot: Dots appear dark and unchanged in size in which LCD panel is displaying under pure red, green, blue picture.
- d) 2 dot adjacent = 1 pair = 2 dots

Picture:

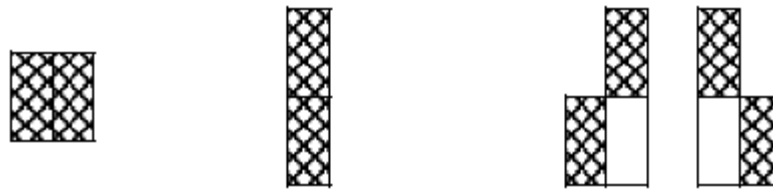

2 dot adjacent

2 dot adjacent (vertical)

2 dot adjacent (slant)

(2) Display Inspection

NO.	Item		Acceptable Count	
1	Dot defect	Bright Dot	Random	$N \leq 2$
			2 dots adjacent	$N \leq 0$
		Dark Dot	Random	$N \leq 3$
			2 dots adjacent	$N \leq 1$
	Total bright and dark dot			$N \leq 4$
Functional failure (V-line/ H-line/Cross line etc.)			Not allowable	
	Mura	It's OK if mura is slight visible through 6% ND filter. (Judged by limit sample if it is necessary)		
2	Newton ring (touch panel)	Orbicular of interference fringes is not allowed in the optimum contrast within the active area under viewing angle.		
3	Distance	Minimum Distance Between Bright Dots	$L \geq 5\text{mm}$	
		Minimum Distance Between Dark Dots	$L \geq 5\text{mm}$	



Messrs.					
Product Specification	Model:	MTF-T057AMSLP-V4	Rev. No.	Issued Date.	Page.
			B	March.13, 09	24 / 33

(3) Appearance inspection

NO.	Item	Standards
1	Panel Crack	Not allow. It is shown in Fig.1.
2	Broken CF Non-lead Side of TFT	The broken in the area of $W > 2\text{mm}$ is ignored, L is ignored. It is shown in Fig.2.
3	Broken Lead Side of TFT	FPC lead, electrical line or alignment mark can't be damaged. It is shown in Fig.3.
4	Broken Corner of TFT at Lead Side	FPC lead, electrical line or alignment mark can't be damaged. It is shown in Fig.4.
5	Burr of TFT / CF Edge	The distance of burr from the edge of TFT / CF, $W \leq 0.3\text{mm}$. It is shown in Fig.5.
6	Foreign Black / White/Bright Spot	(1) $0.15 < D \leq 0.5 \text{ mm}$, $N \leq 4$; (2) $D \leq 0.15\text{mm}$, Ignore. It is shown in Fig.6.
7	Foreign Black / White/Bright Line	(1) $0.05 < W \leq 0.1 \text{ mm}$, $0.3 < L \leq 2 \text{ mm}$, $N \leq 4$.
		(2) $W \leq 0.05\text{mm}$ and $L \leq 0.3\text{mm}$ Ignore. It is shown in Fig.7.
8	Color irregular	Not remarkable color irregular.

Fig.5.

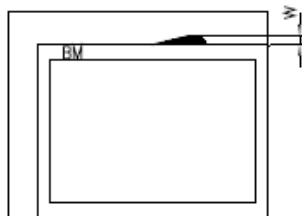

Fig.6.

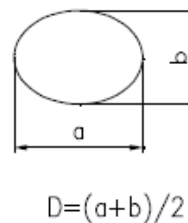

Fig.7.

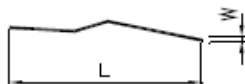
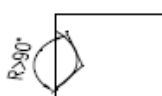

Fig.8.



Notes

1. W : Width
2. L : Length
3. D : Average Diameter
4. N : Count
5. All the angle of the broken must be larger than 90° . It is shown in Fig.8. ($R > 90^\circ$)



Messrs.					
Product Specification	Model:	MTF-T057AMSLP-V4	Rev. No.	Issued Date.	Page.
			B	March.13, 09	25 / 33

9.5.5 External Appearance Defect

NO.	Item	Criterion												
1	Black spots, foreign matter, and white spots (Including light leakage due to pinholes of polarizing plates, etc.)	<p>Spots</p> <table border="1"> <thead> <tr> <th>Average Diameter (mm):D</th> <th>Number of pieces permitted</th> </tr> </thead> <tbody> <tr> <td>$D \leq 0.2$</td> <td>Ignore</td> </tr> <tr> <td>$0.2 < D \leq 0.3$</td> <td>5</td> </tr> <tr> <td>$0.3 < D \leq 0.4$</td> <td>2</td> </tr> <tr> <td>$0.4 < D$</td> <td>0</td> </tr> </tbody> </table> <p>Number of total pieces is set to within 5 pieces.</p> <p>Note that when there are 2 pieces or more, they are not to be concentrated. Set as: Average diameter = (Long diameter + Short diameter)/2</p>	Average Diameter (mm):D	Number of pieces permitted	$D \leq 0.2$	Ignore	$0.2 < D \leq 0.3$	5	$0.3 < D \leq 0.4$	2	$0.4 < D$	0		
Average Diameter (mm):D	Number of pieces permitted													
$D \leq 0.2$	Ignore													
$0.2 < D \leq 0.3$	5													
$0.3 < D \leq 0.4$	2													
$0.4 < D$	0													
2	Line	<p>Lines</p> <table border="1"> <thead> <tr> <th>Width(mm):W</th> <th>Length(mm):L</th> <th>Number of pieces permitted</th> </tr> </thead> <tbody> <tr> <td>$W \leq 0.03$</td> <td>Ignore</td> <td>Ignore</td> </tr> <tr> <td>$0.03 < W \leq 0.08$</td> <td>$L \leq 4$</td> <td>2</td> </tr> <tr> <td>$0.08 < W \leq 0.1$</td> <td>$L \leq 1$</td> <td>1</td> </tr> </tbody> </table> <p>Object exceeding 0.1mm follow the standards of the spots form.</p> <p>Diameter of spots = $\frac{\text{Length} + \text{Width}}{2}$ of Line</p> <p>Note that when there are 2 pieces or more, they are not to be concentrated.</p>	Width(mm):W	Length(mm):L	Number of pieces permitted	$W \leq 0.03$	Ignore	Ignore	$0.03 < W \leq 0.08$	$L \leq 4$	2	$0.08 < W \leq 0.1$	$L \leq 1$	1
Width(mm):W	Length(mm):L	Number of pieces permitted												
$W \leq 0.03$	Ignore	Ignore												
$0.03 < W \leq 0.08$	$L \leq 4$	2												
$0.08 < W \leq 0.1$	$L \leq 1$	1												



Messrs.					
Product Specification	Model:	MTF-T057AMSLP-V4	Rev. No.	Issued Date.	Page.
			B	March.13, 09	26 / 33

3	Air bubbles polarizing plates, and reflection plates	<table border="1"> <thead> <tr> <th>Average Diameter (mm):D</th> <th>Number of pieces permitted</th> <th rowspan="3">Average diameter = (Long diameter + Short diameter)/2</th> </tr> </thead> <tbody> <tr> <td>$D \leq 0.05$</td> <td>Ignore</td> </tr> <tr> <td>$0.05 < D \leq 0.3$</td> <td>3</td> </tr> </tbody> </table> <p>Note that when there are 4 pieces or more, they are not to be concentrated.</p>	Average Diameter (mm):D	Number of pieces permitted	Average diameter = (Long diameter + Short diameter)/2	$D \leq 0.05$	Ignore	$0.05 < D \leq 0.3$	3		
		Average Diameter (mm):D	Number of pieces permitted	Average diameter = (Long diameter + Short diameter)/2							
$D \leq 0.05$	Ignore										
$0.05 < D \leq 0.3$	3										
4	Polarizer Scratch	<p>Dot Line</p> <table border="1"> <thead> <tr> <th>Diameter (Φ) mm</th> <th>Acceptable Number</th> </tr> </thead> <tbody> <tr> <td>$\Phi \leq 0.1$</td> <td>Ignore</td> </tr> <tr> <td>$0.1 < \Phi \leq 0.2$</td> <td>1</td> </tr> <tr> <td>$0.2 \leq \Phi$</td> <td>0</td> </tr> </tbody> </table>	Diameter (Φ) mm	Acceptable Number	$\Phi \leq 0.1$	Ignore	$0.1 < \Phi \leq 0.2$	1	$0.2 \leq \Phi$	0	
		Diameter (Φ) mm	Acceptable Number								
$\Phi \leq 0.1$	Ignore										
$0.1 < \Phi \leq 0.2$	1										
$0.2 \leq \Phi$	0										
		<p>Line Defect</p> <table border="1"> <thead> <tr> <th>Width : (W) mm</th> <th>Length : (L)mm</th> <th>Acceptable Number</th> </tr> </thead> <tbody> <tr> <td>$W \leq 0.03$</td> <td>Ignore</td> <td>Ignore</td> </tr> <tr> <td>$0.03 < W \leq 0.08$</td> <td>$L \leq 4$</td> <td>4</td> </tr> </tbody> </table> <p>If the width more than 0.08, must follow the criteria of dot defect.</p> <p>Diameter of spots = $\frac{\text{Length} + \text{Width}}{2}$ of Line</p>	Width : (W) mm	Length : (L)mm	Acceptable Number	$W \leq 0.03$	Ignore	Ignore	$0.03 < W \leq 0.08$	$L \leq 4$	4
Width : (W) mm	Length : (L)mm	Acceptable Number									
$W \leq 0.03$	Ignore	Ignore									
$0.03 < W \leq 0.08$	$L \leq 4$	4									



Messrs.					
Product Specification	Model:	MTF-T057AMSLP-V4	Rev. No.	Issued Date.	Page.
			<i>B</i>	<i>March.13, 09</i>	<i>27 / 33</i>

NOTICE:

SAFETY

1. If the LCD panel breaks, be careful not to get the liquid crystal to touch your skin.
2. If the liquid crystal touches your skin or clothes, please wash it off immediately by using soap and water.

HANDLING

1. Avoid static electricity which can damage the CMOS LSI.
2. Do not remove the panel or frame from the module.
3. The polarizing plate of the display is very fragile. So, please handle it very carefully.
4. Do not wipe the polarizing plate with a dry cloth, as it may easily scratch the surface of plate.
5. Do not use ketone solvent & Aromatic solvent. Use a soft cloth soaked with a cleaning Naphtha solvent.

STORAGE

1. Store the panel or module in a dark place where the temperature is $25\pm 5^{\circ}\text{C}$ and the humidity is below 65% RH.
2. Do not place the module near organics solvents or corrosive gases.
3. Do not crush, shake, or jolt the module.

TERMS OF WARRANT

1. Acceptance inspection period The period is within one month after the arrival of contracted commodity at the buyer's factory site.
2. Applicable warrant period
The period is within twelve months since the date of shipping out under normal using and storage conditions.



Microtips Technology Inc.

Messrs.					
Product Specification	Model:	MTF-T057AMSLP-V4	Rev. No.	Issued Date.	Page.
			B	March.13, 09	28 / 33

10. RELIABILITY CONDITION

10.1 LCM Reliability Test

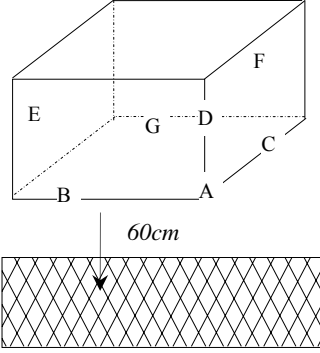
No.	Parameter	Condition
1	High Temperature Operating	70°C±2°C, 240 hrs (Operation state)
2	Low Temperature Operating	-20°C±2°C, 240 hrs (Operation state)
3	High Temperature Storage	80°C±2°C, 240 hrs
4	Low Temperature Storage	-30°C±2°C, 240 hrs
5	Damp Proof Test	40°C±2°C, 90~95%, 96hrs
6	Vibration Test	Total fixed amplitude: 1.5mm Vibration Frequency: 10~55Hz One cycle 60 seconds to 3 direction of X, Y, Z each 15 minutes.
7	Shock Test	To be measured after dropping from 60cm high on the concrete surface in packing state.  <i>Dropping method corner dropping</i> A corner: once <i>Edge dropping</i> B, C, D edge: once <i>Face dropping</i> E, F, G face: once

- Notes:
- No dew condensation to be observed.
 - The function test shall be conducted after 4 hours storage at the normal temperature and humidity after removed from the test chamber.
 - Vibration test will be conducted to the product itself without putting I in a container.

10.2 Touch panel Reliability

No.	Items	Min.	Typ.	Max.	Unit	Remark
1	Activation Force	100	130	150	g	1. within active area. 2. R8.0mm polyacetal pen or finger.
2	Surface Hardness	3	--	--	H	Judgment ref. JIS-K5600
3	Durability (Writing Life)	100,000	--	--	characters	1. within active area. 2. R0.8mm polyacetal pen. 3. Load: 150g 4. Speed: 60mm/sec
4	Durability (Hitting Life)	1,000,000	--	--	touches	1. within active area. 2. R0.8mm polyacetal pen. 3. Load: 250g 4. Frequency: 3 times/sec



Microtips Technology Inc.

Messrs.					
Product Specification	Model:	MTF-T057AMSLP-V4	Rev. No.	Issued Date.	Page.
			<i>B</i>	<i>March.13, 09</i>	<i>29 / 33</i>

11. PRECAUTIONS





11.1 Operation

Burn-in sometimes happens when the same character was displayed at along time. Therefore, to prevent Burn-in, it is recommended to set up a Screen-saver function.

11.2 Safety

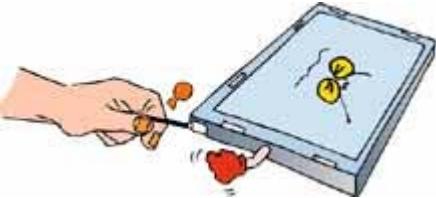
The liquid crystal in the LCD is poisonous, DO NOT put it in your mouth. If the liquid crystal touches your skin or clothes, wash it off immediately using soap and water.







11.3 Handling

	<p>a. The LCD module shall be installed flat, without twisting or bending.</p> <p>b. COF or FPC has narrow pattern width, so easily become open circuit by external force. DO NOT apply pressure to COF or FPC especially in bending area.</p>
	<p>c. To avoid damage in appearance or malfunction, DO NOT subject the module to mechanical shock or to excessive force on its surface.</p>
	<p>d. The polarizer attached to the display is very easy to be damaged, handle it with care to avoid scratching.</p>
	<p>e. To avoid contamination on the display surface, DO NOT touch the display surface with bare hands.</p> <p>f. Provide a space so that the LCD module does not come into contact with other components.</p>

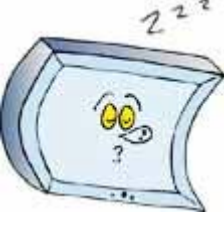

Messrs.

Product Specification	Model:	MTF-T057AMSLP-V4	Rev. No.	Issued Date.	Page.
			<i>B</i>	<i>March.13, 09</i>	<i>30 / 33</i>

	<p>g. To protect the LCD panel from external pressure, put covering glass (acrylic board or similar board) to keep appropriate space between them.</p>
	<p>h. Be careful for condensation at sudden temperature change. Condensation makes damage to polarizer or electrical contacted parts. And after fading condensation, smear or spot will occur.</p>
	<p>i. Property of semiconductor devices may be affected when they are exposed to light possibly resulting in malfunctioning of the ICs. To prevent such malfunctioning of the ICs, your design and mounting layout done are so that the IC is not exposed to light in actual use.</p>
	<p>j. Strong light exposure causes degradation of color filter. It may not recover</p>
	<p>k. DO NOT contact with water to avoid Metal corrosion.</p> <p>l. When it is not in use, the screen must be turned off or the pattern must be frequently changed by a screen saver. If it displays the same pattern for a long period of time, brightness down/image sticking may develop due to the LCD structure.</p>
	<p>m. Never disassemble LCD product under any circumstances. If unqualified operators or users assemble the product after disassembling it, it may not function or its operation may be seriously affected.</p>



Messrs.					
Product Specification	Model:	MTF-T057AMSLP-V4	Rev. No.	Issued Date.	Page.
			<i>B</i>	<i>March.13, 09</i>	<i>31 / 33</i>

11.4 Static electricity

Since a module is composed of electronic circuits, it is not strong to electrostatic discharge.

	<ol style="list-style-type: none"> The LCD module shall be installed flat, without twisting or bending. Ground soldering iron tips, tools and testers when they operate. Ground your body when handling the products. DO NOT apply voltage to the input terminal without applying power supply. DO NOT apply voltage that exceeds the absolute maximum rating. Store the products in an anti-electrostatic container. Peel off protect tape, attached to polarizer, slowly to minimize ESD damage.
---	--

11.5 Storage

	<p>Store the products in a dark place at +5 ~ +25 degree C, low humidity (50%RH or less). DO NOT store the products in an atmosphere containing organic solvents or corrosive gases.</p>
---	--

11.6 Cleaning

	<ol style="list-style-type: none"> DO NOT wipe the polarizer with dry cloth, as it might cause scratch. Wipe the polarizer with a soft cloth soaked with petroleum IPA, other chemical might damage.
---	--

11.7 Waste

	<p>When dispose of LCD module, manage it at the production waste according to the relevant laws and regulations.</p>
---	--



Messrs.					
Product Specification	Model:	MTF-T057AMSLP-V4	Rev. No.	Issued Date.	Page.
			<i>B</i>	<i>March.13, 09</i>	<i>32 / 33</i>

12. WARRANTY

This product has been manufactured to your company's specifications as a part for use in your company's general electronic products. It is guaranteed to perform according to delivery specifications. For any other use apart from general electronic equipment, we cannot take responsibility if the product is used in medical devices, nuclear power control equipment, aerospace equipment, fire and security systems, or any other applications in which there is a direct risk to human life and where extremely high levels of reliability are required. If the product is to be used in any of the above applications, we will need to enter into a separate product liability agreement.

- 1 13 months guarantee starts from the date code.
- 2 We cannot accept responsibility for any defect, which may arise from additional manufacturing of the product (including disassembly and reassembly), after product delivery.
- 3 We cannot accept responsibility for any defect, which may arise after the application of strong external force to the product.
- 4 We cannot accept responsibility for any defect, which may arise due to the application of static electricity after the product has passed your company's acceptance inspection procedures.
- 5 We cannot accept responsibility for industrial property, which may arise through the use of your product, with exception to those issues relating directly to the structure or method of manufacturing of our product. Microtips-origin longer than one year from Microtips production.

13. DIMENSIONAL OUTLINES

See next page.....



Microtips Technology Inc.

REV. A	DESCRIPTION	DRAWN	CHECK	APP'D	DATE
	PRODUCTION RELEASE	Abbie	CAROL		06/17/08

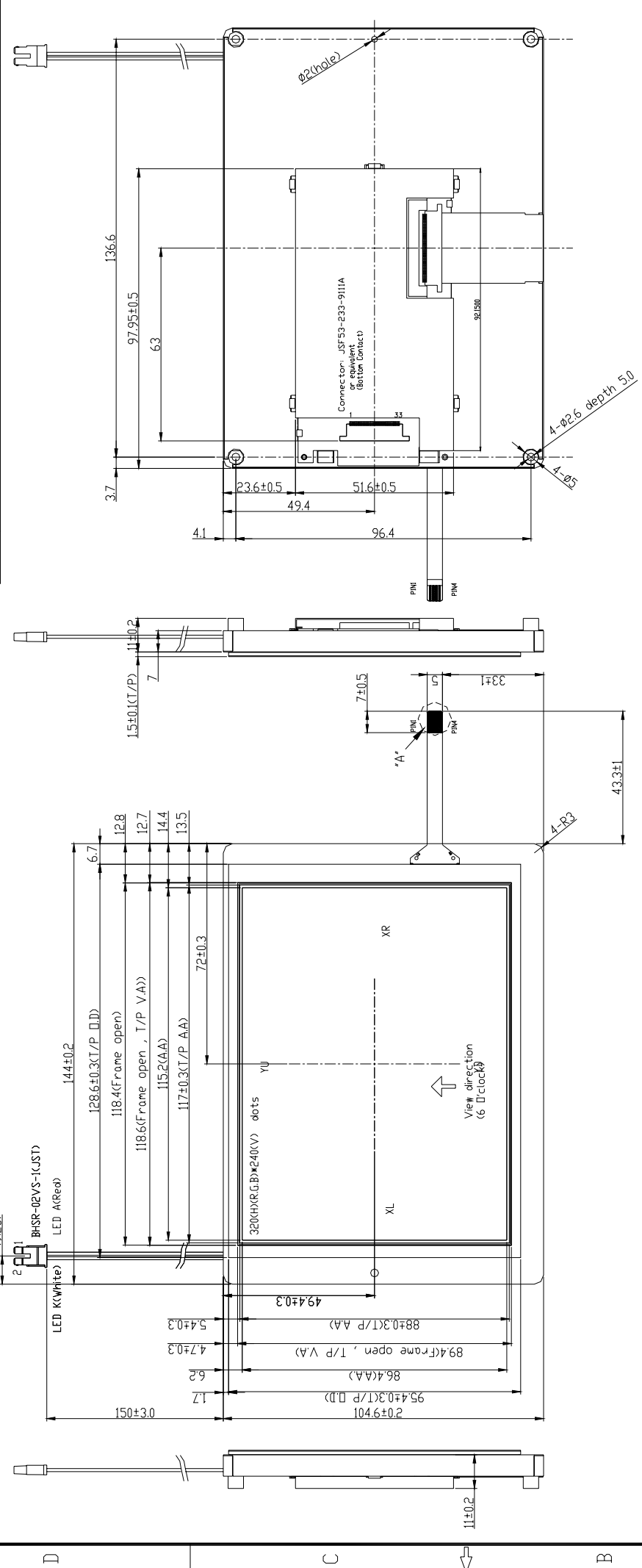

PART NAME		QTY		DATE		MATERIAL		FINISH	
WF-1057AMSIP-14				06/17/08					
DRAWN		CHECK		APP'D		SCALE: 1/1		PRODUCT:	
Abbie		Carol				UNLESS OTHERWISE SPECIFIED TOLERANCE ON FRACTIONS DECIMALS ANGLES 0.20 0.5°		WF-1057AMSIP-14	
Microtips Technology						DWG NO:		F057AMSIP-14	
						FILE: DWG\Design\MPD\WF-1057AMSIP-14_2D		SHEET 1 / 1	
								Rev: A	

PIN ASSIGNMENT	
PIN NO	DESIGNATION
1	YU
2	XR
3	YD
4	XL

PIN ASSIGNMENT:	
1:DGND	11:R5
2:DCLK	12:GND
3:HSYNC	13:G0
4:VSYNC	14:G1
5:GND	15:G2
6:R0	16:G3
7:R1	17:G4
8:R2	18:G5
9:R3	19:GND
10:R4	20:R0
21:R1	31:UDC
22:R2	32:NC
23:R3	33:GND
24:R4	
25:R5	
26:GND	
27:DEN	
28:VDD	
29:VDD	
30:LR	

BL Circuit Diagram

Backlight: Test condition: IF=30mA (定電流), VF=6.6V(TYP)