

# 74CBTLV3125

## 4-bit bus switch

Rev. 5 — 8 October 2018

Product data sheet

## 1. General description

---

The 74CBTLV3125 provides a 4-bit high-speed bus switch with separate output enable inputs ( $1\overline{OE}$  to  $4\overline{OE}$ ). The low on-state resistance of the switch allows connections to be made with minimal propagation delay. The switch is disabled (high-impedance OFF-state) when the output enable ( $n\overline{OE}$ ) input is HIGH.

To ensure the high-impedance OFF-state during power-up or power-down,  $n\overline{OE}$  should be tied to the  $V_{CC}$  through a pull-up resistor. The minimum value of the resistor is determined by the current-sinking capability of the driver.

Schmitt trigger action at control input makes the circuit tolerant to slower input rise and fall times across the entire  $V_{CC}$  range from 2.3 V to 3.6 V.

This device is fully specified for partial power-down applications using  $I_{OFF}$ . The  $I_{OFF}$  circuitry disables the output, preventing the damaging backflow current through the device when it is powered down.

## 2. Features and benefits

---

- Supply voltage range from 2.3 V to 3.6 V
- Standard '125'-type pinout
- High noise immunity
- Complies with JEDEC standard:
  - JESD8-5 (2.3 V to 2.7 V)
  - JESD8-B/JESD36 (2.7 V to 3.6 V)
- ESD protection:
  - HBM JESD22-A114F exceeds 2000 V
  - MM JESD22-A115-A exceeds 200 V
  - CDM AEC-Q100-011 revision B exceeds 1000 V
- 5  $\Omega$  switch connection between two ports
- Rail to rail switching on data I/O ports
- CMOS low power consumption
- Latch-up performance exceeds 250 mA per JESD78B Class I level A
- $I_{OFF}$  circuitry provides partial Power-down mode operation
- Multiple package options
- Specified from -40 °C to +85 °C and -40 °C to +125 °C

### 3. Ordering information

Table 1. Ordering information

| Type number   | Package           |            |  | Version  |
|---------------|-------------------|------------|--|----------|
|               | Temperature range | Name       | Description  |          |
| 74CBTLV3125DS | -40 °C to +125 °C | SSOP16 [1] | plastic shrink small outline package; 16 leads; body width 3.9 mm; lead pitch 0.635 mm                                       | SOT519-1 |
| 74CBTLV3125PW | -40 °C to +125 °C | TSSOP14    | plastic thin shrink small outline package; 14 leads; body width 4.4 mm   | SOT402-1 |
| 74CBTLV3125BQ | -40 °C to +125 °C | DHVQFN14   | plastic dual in-line compatible thermal enhanced very thin quad flat package; no leads; 14 terminals; body 2.5 x 3 x 0.85 mm | SOT762-1 |

[1] Also known as QSOP16.

### 4. Functional diagram

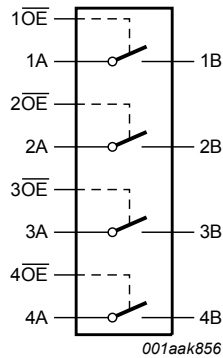

Fig. 1. Logic symbol

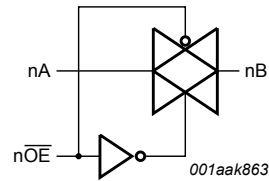
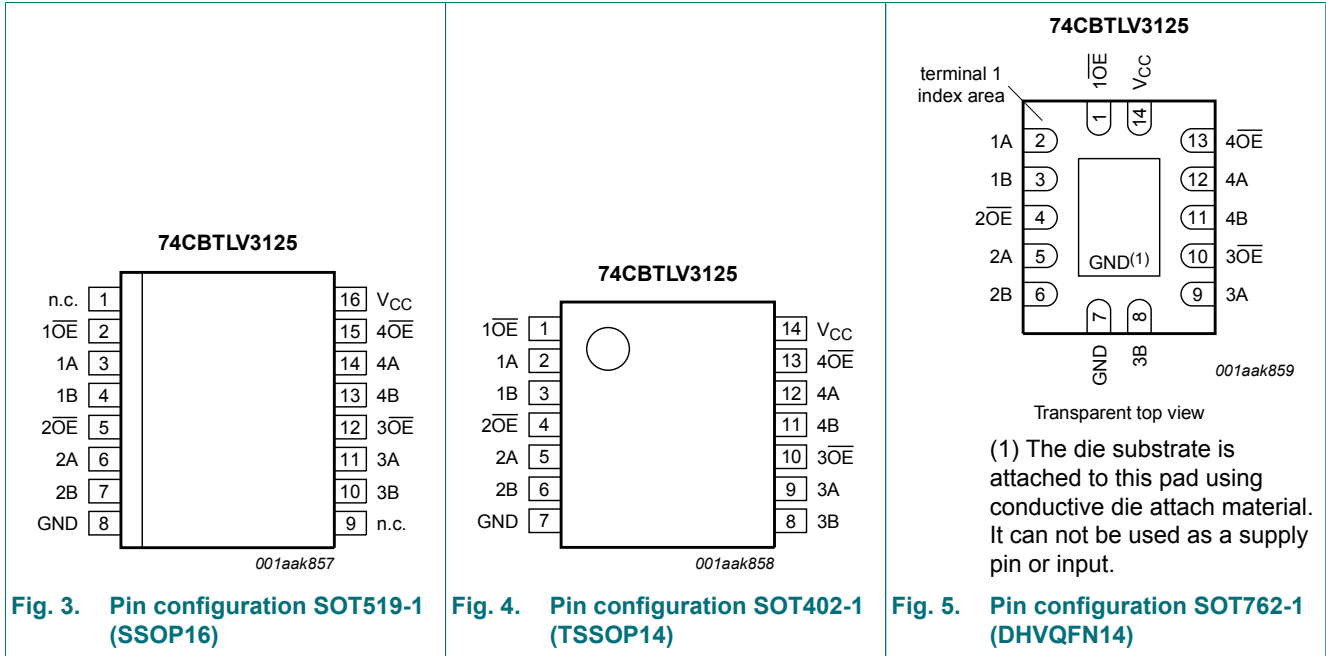

Fig. 2. Logic diagram (one switch)

## 5. Pinning information

### 5.1. Pinning



### 5.2. Pin description

Table 2. Pin description

| Symbol             | Pin          |                       | Description             |
|--------------------|--------------|-----------------------|-------------------------|
|                    | SOT519-1     | SOT402-1 and SOT762-1 |                         |
| 1OE, 2OE, 3OE, 4OE | 2, 5, 12, 15 | 1, 4, 10, 13          | output enable input     |
| 1A, 2A, 3A, 4A,    | 3, 6, 11, 14 | 2, 5, 9, 12           | A input/output          |
| 1B, 2B, 3B, 4B     | 4, 7, 10, 13 | 3, 6, 8, 11           | B output/input          |
| GND                | 8            | 7                     | ground (0 V)            |
| V <sub>CC</sub>    | 16           | 14                    | positive supply voltage |
| n.c.               | 1, 9         | -                     | not connected           |

## 6. Functional description

Table 3. Function table

H = HIGH voltage level; L = LOW voltage level.

| Output enable input OE | Function switch |
|------------------------|-----------------|
| L                      | ON-state        |
| H                      | OFF-state       |

## 7. Limiting values

**Table 4. Limiting values**

In accordance with the Absolute Maximum Rating System (IEC 60134). Voltages are referenced to GND (ground = 0 V).

| Symbol    | Parameter               | Conditions                        | Min  | Max            | Unit |
|-----------|-------------------------|-----------------------------------|------|----------------|------|
| $V_{CC}$  | supply voltage          |                                   | -0.5 | +4.6           | V    |
| $V_I$     | input voltage           | control inputs [1]                | -0.5 | +4.6           | V    |
| $V_{SW}$  | switch voltage          | enable and disable mode [2]       | -0.5 | $V_{CC} + 0.5$ | V    |
| $I_{IK}$  | input clamping current  | $V_I < -0.5$ V                    | -50  | -              | mA   |
| $I_{SK}$  | switch clamping current | $V_I < -0.5$ V                    | -50  | -              | mA   |
| $I_{SW}$  | switch current          | $V_{SW} = 0$ V to $V_{CC}$        | -    | $\pm 128$      | mA   |
| $I_{CC}$  | supply current          |                                   | -    | +100           | mA   |
| $I_{GND}$ | ground current          |                                   | -100 | -              | mA   |
| $T_{stg}$ | storage temperature     |                                   | -65  | +150           | °C   |
| $P_{tot}$ | total power dissipation | $T_{amb} = -40$ °C to +125 °C [3] | -    | 500            | mW   |

[1] The minimum input voltage rating may be exceeded if the input clamping current ratings are observed.

[2] The switch voltage ratings may be exceeded if switch clamping current ratings are observed

[3] For SSOP16 and TSSOP14 packages:  $P_{tot}$  derates linearly with 5.5 mW/K above 60 °C.

For DHVQFN14 packages:  $P_{tot}$  derates linearly with 4.5 mW/K above 60 °C.

## 8. Recommended operating conditions

**Table 5. Recommended operating conditions**

| Symbol              | Parameter                           | Conditions                         | Min | Max      | Unit |
|---------------------|-------------------------------------|------------------------------------|-----|----------|------|
| $V_{CC}$            | supply voltage                      |                                    | 2.3 | 3.6      | V    |
| $V_I$               | input voltage                       | control inputs                     | 0   | 3.6      | V    |
| $V_{SW}$            | switch voltage                      | enable and disable mode            | 0   | $V_{CC}$ | V    |
| $T_{amb}$           | ambient temperature                 |                                    | -40 | +125     | °C   |
| $\Delta t/\Delta V$ | input transition rise and fall rate | pin nOE; $V_{CC} = 2.3$ V to 3.6 V | 0   | 200      | ns/V |

## 9. Static characteristics

**Table 6. Static characteristics**

At recommended operating conditions voltages are referenced to GND (ground = 0 V).

| Symbol              | Parameter                 | Conditions   | T <sub>amb</sub> = -40 °C to +85 °C |        |      | T <sub>amb</sub> = -40 °C to +125 °C |      | Unit |
|---------------------|---------------------------|--|-------------------------------------|--------|------|--------------------------------------|------|------|
|                     |                           |  | Min                                 | Typ[1] | Max  | Min                                  | Max  |      |
| V <sub>IH</sub>     | HIGH-level input voltage  | V <sub>CC</sub> = 2.3 V to 2.7 V   | 1.7                                 | -      | -    | 1.7                                  | -    | V    |
|                     |                           | V <sub>CC</sub> = 3.0 V to 3.6 V   | 2.0                                 | -      | -    | 2.0                                  | -    | V    |
| V <sub>IL</sub>     | LOW-level input voltage   | V <sub>CC</sub> = 2.3 V to 2.7 V   | -                                   | -      | 0.7  | -                                    | 0.7  | V    |
|                     |                           | V <sub>CC</sub> = 3.0 V to 3.6 V   | -                                   | -      | 0.9  | -                                    | 0.9  | V    |
| I <sub>I</sub>      | input leakage current     | pin n $\overline{OE}$ ; V <sub>I</sub> = GND to V <sub>CC</sub> ; V <sub>CC</sub> = 3.6 V  | -                                   | -      | ±1.0 | -                                    | ±20  | µA   |
| I <sub>S(OFF)</sub> | OFF-state leakage current | V <sub>CC</sub> = 3.6 V; see Fig. 6  | -                                   | -      | ±1   | -                                    | ±20  | µA   |
| I <sub>S(ON)</sub>  | ON-state leakage current  | V <sub>CC</sub> = 3.6 V; see Fig. 7  | -                                   | -      | ±1   | -                                    | ±20  | µA   |
| I <sub>OFF</sub>    | power-off leakage current | V <sub>I</sub> or V <sub>O</sub> = 0 V to 3.6 V; V <sub>CC</sub> = 0 V   | -                                   | -      | ±10  | -                                    | ±50  | µA   |
| I <sub>CC</sub>     | supply current            | V <sub>I</sub> = GND or V <sub>CC</sub> ; I <sub>O</sub> = 0 A; V <sub>SW</sub> = GND or V <sub>CC</sub> ; V <sub>CC</sub> = 3.6 V       | -                                   | -      | 10   | -                                    | 50   | µA   |
| ΔI <sub>CC</sub>    | additional supply current | pin n $\overline{OE}$ ; V <sub>I</sub> = V <sub>CC</sub> - 0.6 V; V <sub>SW</sub> = GND or V <sub>CC</sub> ; V <sub>CC</sub> = 3.6 V [2] | -                                   | -      | 300  | -                                    | 2000 | µA   |
| C <sub>I</sub>      | input capacitance         | pin n $\overline{OE}$ ; V <sub>CC</sub> = 3.3 V; V <sub>I</sub> = 0 V to 3.3 V   | -                                   | 0.9    | -    | -                                    | -    | pF   |
| C <sub>S(OFF)</sub> | OFF-state capacitance     | V <sub>CC</sub> = 3.3 V; V <sub>I</sub> = 0 V to 3.3 V   | -                                   | 5.2    | -    | -                                    | -    | pF   |
| C <sub>S(ON)</sub>  | ON-state capacitance      | V <sub>CC</sub> = 3.3 V; V <sub>I</sub> = 0 V to 3.3 V   | -                                   | 14.3   | -    | -                                    | -    | pF   |

[1] All typical values are measured at T<sub>amb</sub> = 25 °C.

[2] One input at 3 V, other inputs at V<sub>CC</sub> or GND.

### 9.1. Test circuits

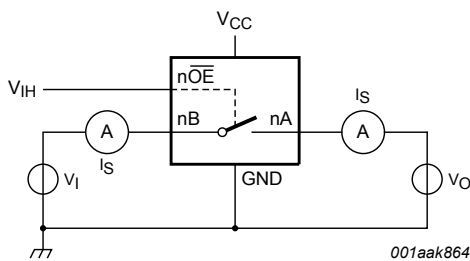

V<sub>I</sub> = V<sub>CC</sub> or GND and V<sub>O</sub> = GND or V<sub>CC</sub>.

**Fig. 6. Test circuit for measuring OFF-state leakage current (one switch)**

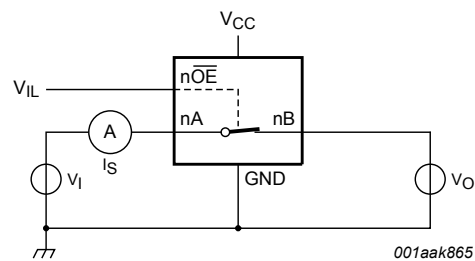

V<sub>I</sub> = V<sub>CC</sub> or GND and V<sub>O</sub> = open circuit.

**Fig. 7. Test circuit for measuring ON-state leakage current (one switch)**

### 9.2. ON resistance

**Table 7. Resistance  $R_{ON}$**

At recommended operating conditions; voltages are referenced to GND (ground = 0 V); for test circuit see Fig. 8.

| Symbol   | Parameter     | Conditions   | $T_{amb} = -40\text{ }^{\circ}\text{C}$ to $+85\text{ }^{\circ}\text{C}$ |         |      | $T_{amb} = -40\text{ }^{\circ}\text{C}$ to $+125\text{ }^{\circ}\text{C}$ |      | Unit     |
|--|---------------|--|--|---------|------|---|------|----------|
|  |               |  | Min  | Typ [1] | Max  | Min   | Max  |          |
| $R_{ON}$                                       | ON resistance | $V_{CC} = 2.3\text{ V}$ to $2.7\text{ V}$ ;<br>see Fig. 9 to Fig. 11 [2] |  |         |      |   |      |          |
|  |               | $I_{SW} = 64\text{ mA}$ ; $V_I = 0\text{ V}$                             | -  | 4.2     | 8.0  | -   | 15.0 | $\Omega$ |
|  |               | $I_{SW} = 24\text{ mA}$ ; $V_I = 0\text{ V}$                             | -  | 4.2     | 8.0  | -   | 15.0 | $\Omega$ |
|  |               | $I_{SW} = 15\text{ mA}$ ; $V_I = 1.7\text{ V}$                           | -  | 8.4     | 40.0 | -   | 60.0 | $\Omega$ |
|  |               | $V_{CC} = 3.0\text{ V}$ to $3.6\text{ V}$ ;<br>see Fig. 12 to Fig. 14    |  |         |      |   |      |          |
|  |               | $I_{SW} = 64\text{ mA}$ ; $V_I = 0\text{ V}$                             | -  | 4.0     | 7.0  | -   | 11.0 | $\Omega$ |
|  |               | $I_{SW} = 24\text{ mA}$ ; $V_I = 0\text{ V}$                             | -  | 4.0     | 7.0  | -   | 11.0 | $\Omega$ |
| $I_{SW} = 15\text{ mA}$ ; $V_I = 2.4\text{ V}$ | -             | 6.2  | 15.0   | -       | 25.5 | $\Omega$  |      |          |

- [1] Typical values are measured at  $T_{amb} = 25\text{ }^{\circ}\text{C}$  and nominal  $V_{CC}$ .
- [2] Measured by the voltage drop between the A and B terminals at the indicated current through the switch. ON-state resistance is determined by the lower of the voltages of the two (A or B) terminals.

### 9.3. ON resistance test circuit and graphs

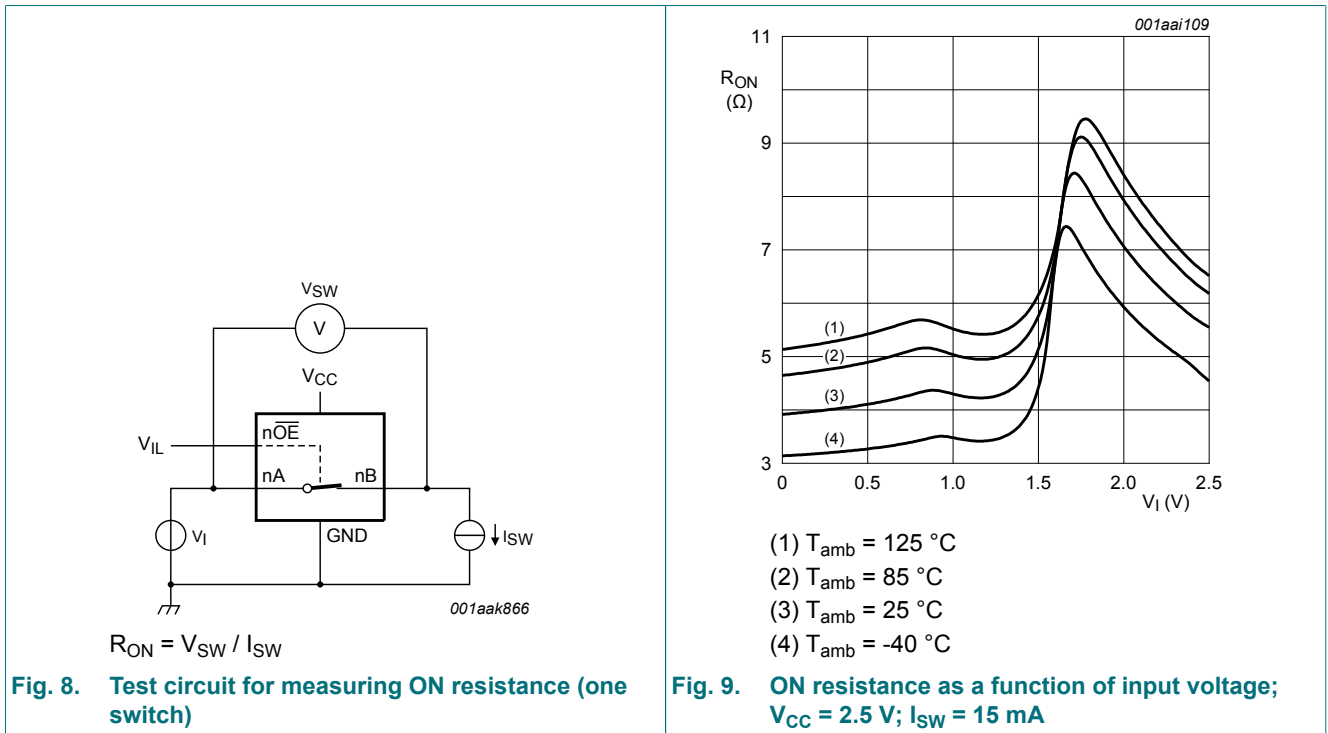

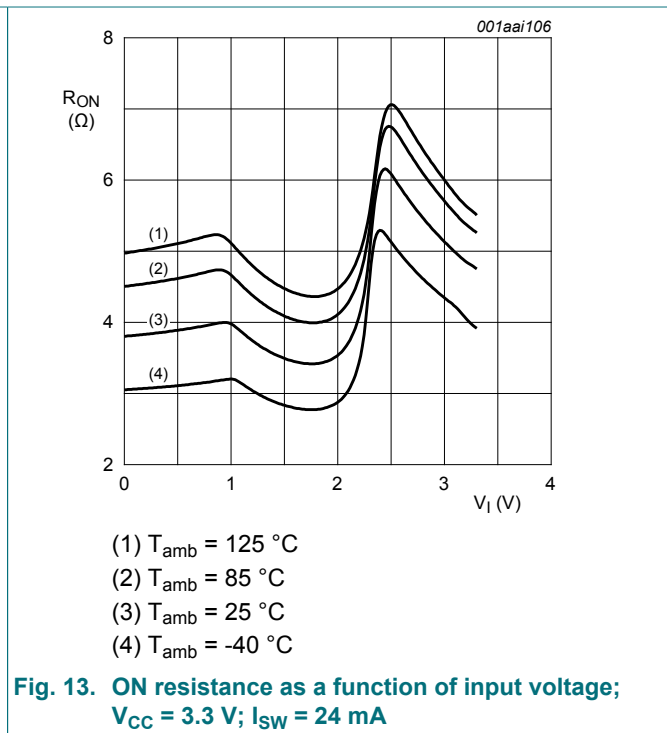
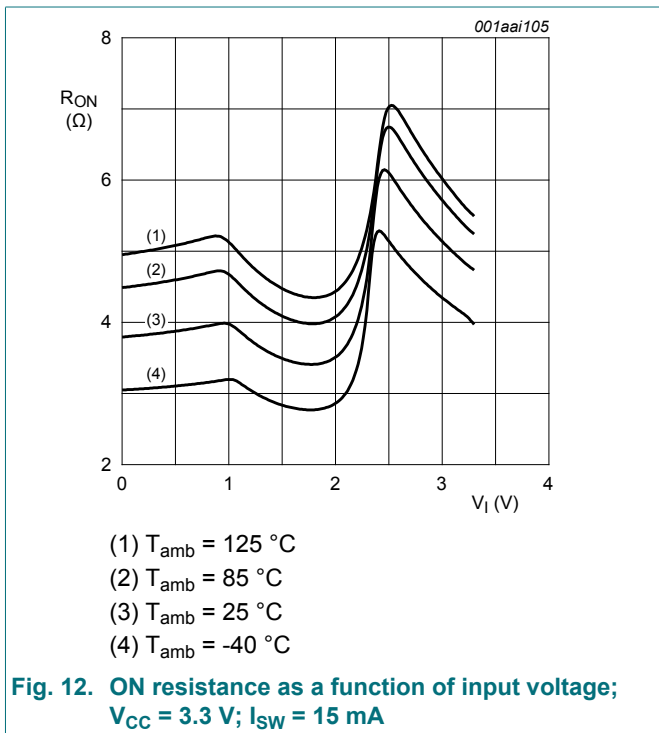
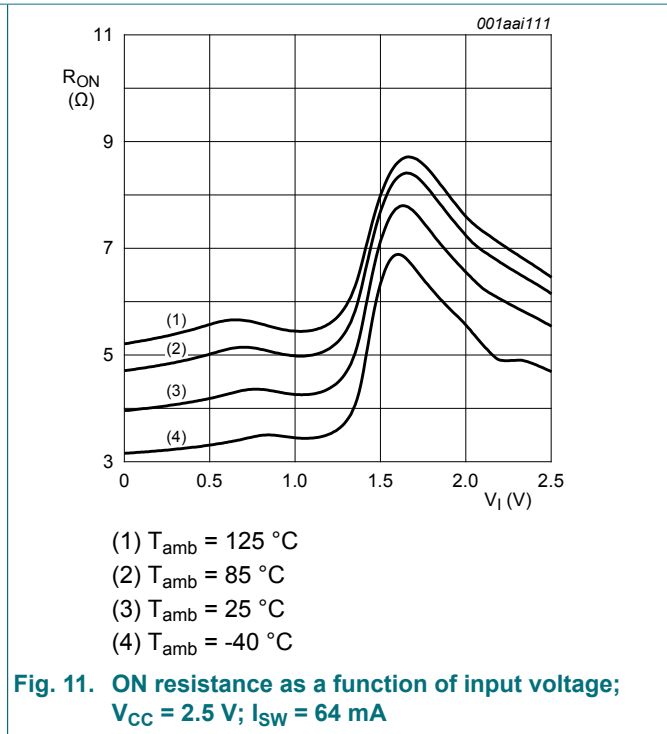
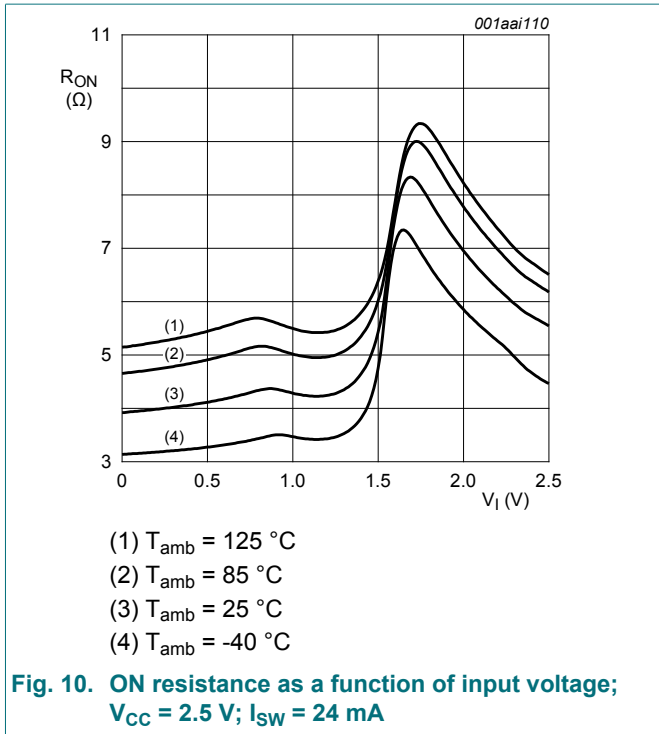

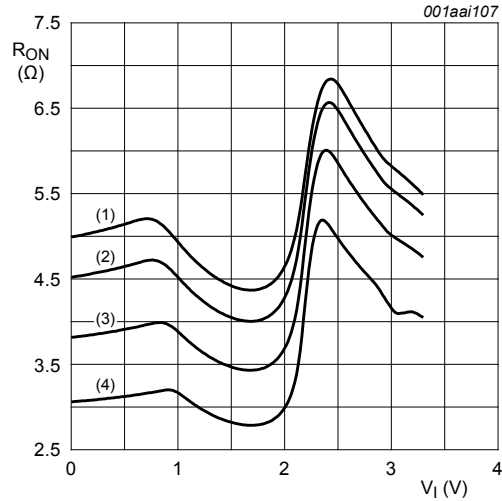

- (1)  $T_{amb} = 125\text{ °C}$
- (2)  $T_{amb} = 85\text{ °C}$
- (3)  $T_{amb} = 25\text{ °C}$
- (4)  $T_{amb} = -40\text{ °C}$

Fig. 14. ON resistance as a function of input voltage;  $V_{CC} = 3.3\text{ V}$ ;  $I_{SW} = 64\text{ mA}$

## 10. Dynamic characteristics

Table 8. Dynamic characteristics

$GND = 0\text{ V}$ ; for test circuit see Fig. 17

| Symbol    | Parameter         | Conditions                                    | $T_{amb} = -40\text{ °C to }+85\text{ °C}$ |        |      | $T_{amb} = -40\text{ °C to }+125\text{ °C}$ |      | Unit |
|-----------|-------------------|---|--|--------|------|---|------|------|
|           |                   |   | Min  | Typ[1] | Max  | Min   | Max  |      |
| $t_{pd}$  | propagation delay | nA to nB or nB to nA; see Fig. 15 [2] [3]     |  |        |      |   |      |      |
|           |                   | $V_{CC} = 2.3\text{ V to }2.7\text{ V}$       | -  | -      | 0.13 | -   | 0.20 | ns   |
|           |                   | $V_{CC} = 3.0\text{ V to }3.6\text{ V}$       | -  | -      | 0.20 | -   | 0.31 | ns   |
| $t_{en}$  | enable time       | $\overline{nOE}$ to nA or nB; see Fig. 16 [4] |  |        |      |   |      |      |
|           |                   | $V_{CC} = 2.3\text{ V to }2.7\text{ V}$       | 1.0  | 2.7    | 4.6  | 1.0   | 6.0  | ns   |
|           |                   | $V_{CC} = 3.0\text{ V to }3.6\text{ V}$       | 1.0  | 2.4    | 4.4  | 1.0   | 6.0  | ns   |
| $t_{dis}$ | disable time      | $\overline{nOE}$ to nA or nB; see Fig. 16 [5] |  |        |      |   |      |      |
|           |                   | $V_{CC} = 2.3\text{ V to }2.7\text{ V}$       | 1.0  | 2.2    | 3.9  | 1.0   | 5.5  | ns   |
|           |                   | $V_{CC} = 3.0\text{ V to }3.6\text{ V}$       | 1.0  | 2.9    | 4.2  | 1.0   | 5.5  | ns   |

- [1] All typical values are measured at  $T_{amb} = 25\text{ °C}$  and at nominal  $V_{CC}$ .
- [2] The propagation delay is the calculated RC time constant of the typical on-state resistance of the switch and the load capacitance, when driven by an ideal voltage source (zero output impedance).
- [3]  $t_{pd}$  is the same as  $t_{PLH}$  and  $t_{PHL}$ .
- [4]  $t_{en}$  is the same as  $t_{PZH}$  and  $t_{PZL}$ .
- [5]  $t_{dis}$  is the same as  $t_{PHZ}$  and  $t_{PLZ}$ .



10.1. Waveforms and test circuit

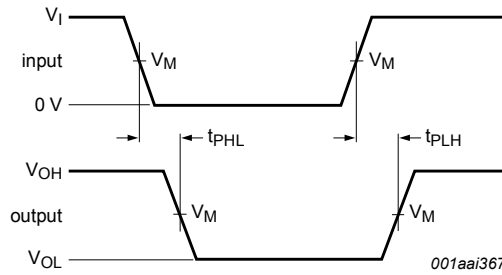

Measurement points are given in [Table 9](#).

Logic levels:  $V_{OL}$  and  $V_{OH}$  are typical output voltage levels that occur with the output load.

Fig. 15. The data input (nA or nB) to output (nB or nA) propagation delays

Table 9. Measurement points

| Supply voltage | Input       |          |               | Output      |                   |                   |
|----------------|-------------|----------|---------------|-------------|-------------------|-------------------|
| $V_{CC}$       | $V_M$       | $V_I$    | $t_r = t_f$   | $V_M$       | $V_X$             | $V_Y$             |
| 2.3 V to 2.7 V | $0.5V_{CC}$ | $V_{CC}$ | $\leq 2.0$ ns | $0.5V_{CC}$ | $V_{OL} + 0.15$ V | $V_{OH} - 0.15$ V |
| 3.0 V to 3.6 V | $0.5V_{CC}$ | $V_{CC}$ | $\leq 2.0$ ns | $0.5V_{CC}$ | $V_{OL} + 0.3$ V  | $V_{OH} - 0.3$ V  |

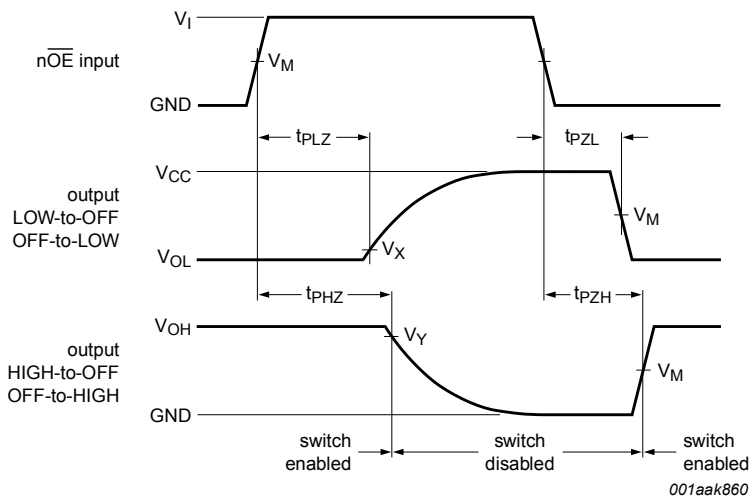

Measurement points are given in [Table 9](#).

Logic levels:  $V_{OL}$  and  $V_{OH}$  are typical output voltage levels that occur with the output load.

Fig. 16. Enable and disable times

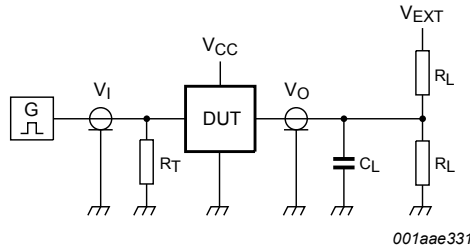
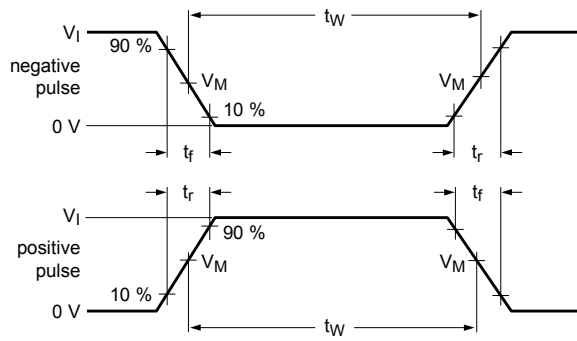

001aae331

Test data is given in [Table 10](#).

Definitions for test circuit:

$R_L$  = Load resistance.

$C_L$  = Load capacitance including jig and probe capacitance.

$R_T$  = Termination resistance should be equal to the output impedance  $Z_o$  of the pulse generator.

$V_{EXT}$  = External voltage for measuring switching times.

**Fig. 17. Test circuit for measuring switching times**

**Table 10. Test data**

| Supply voltage | Load  |              | $V_{EXT}$          |                    |                    |
|----------------|-------|--------------|--------------------|--------------------|--------------------|
|                | $C_L$ | $R_L$        | $t_{PLH}, t_{PHL}$ | $t_{PZH}, t_{PHZ}$ | $t_{PZL}, t_{PLZ}$ |
| 2.3 V to 2.7 V | 30 pF | 500 $\Omega$ | open               | GND                | $2V_{CC}$          |
| 3.0 V to 3.6 V | 50 pF | 500 $\Omega$ | open               | GND                | $2V_{CC}$          |

10.2. Additional dynamic characteristics

Table 11. Additional dynamic characteristics

At recommended operating conditions; voltages are referenced to GND (ground = 0 V).

| Symbol               | Parameter                | Conditions  | T <sub>amb</sub> = 25 °C |     |     | Unit |
|----------------------|--------------------------|---|--------------------------|-----|-----|------|
|                      |                          |   | Min                      | Typ | Max |      |
| f <sub>i(-3dB)</sub> | -3 dB frequency response | V <sub>I</sub> = GND or V <sub>CC</sub> ; t <sub>r</sub> = t <sub>f</sub> ≤ 2.5 ns; V <sub>CC</sub> = 3.3 V; R <sub>L</sub> = 50 Ω; see Fig. 18 | -                        | 406 | -   | MHz  |

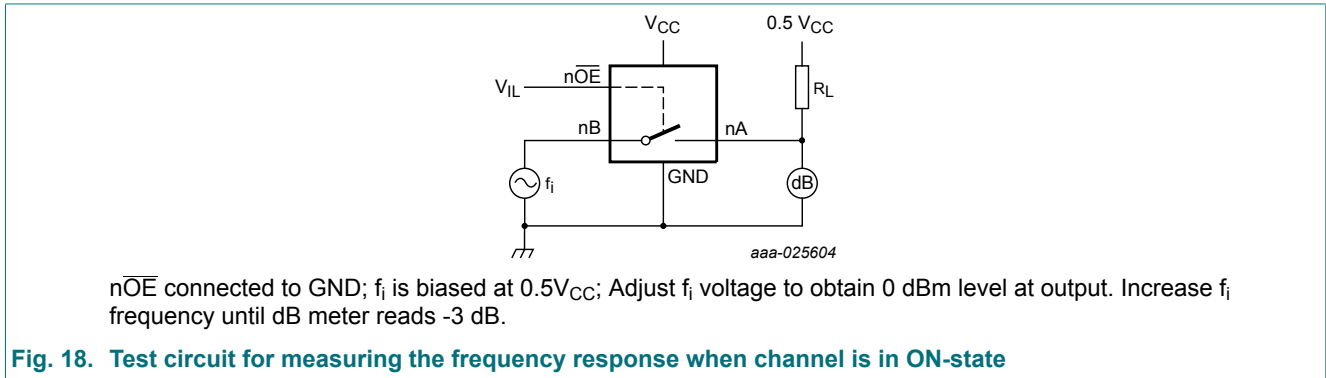
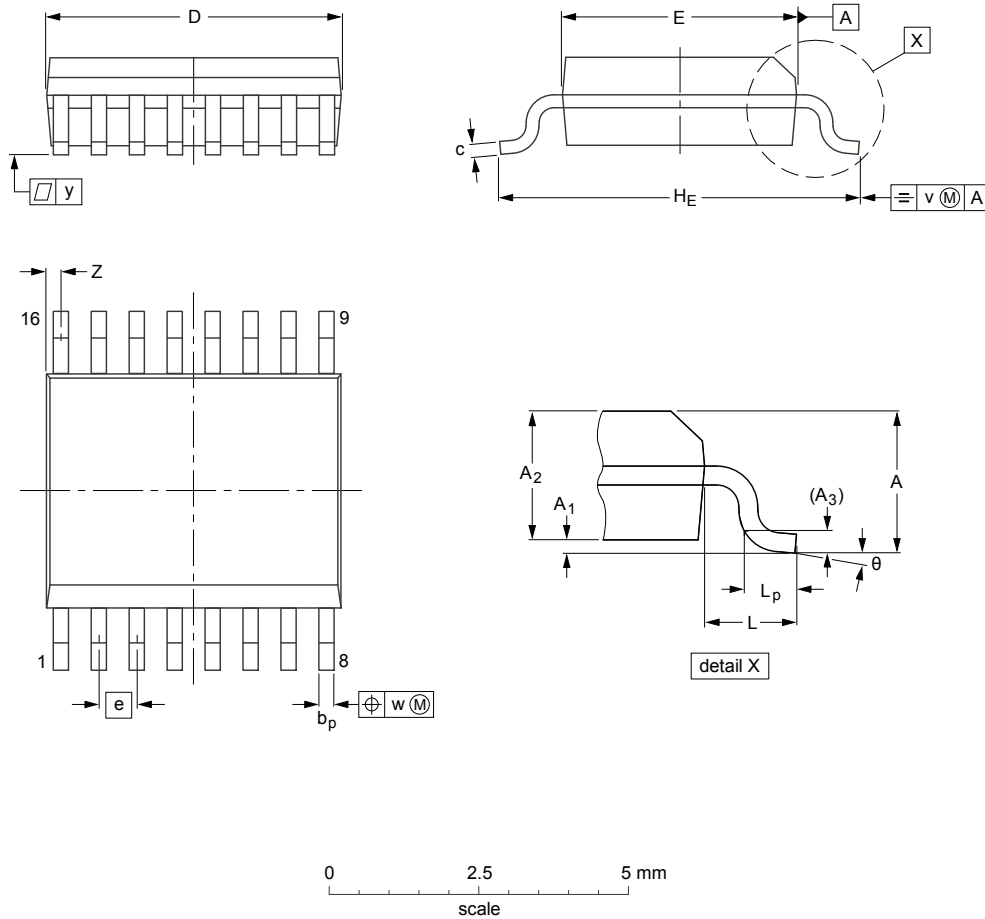

Fig. 18. Test circuit for measuring the frequency response when channel is in ON-state

### 11. Package outline

SSOP16: plastic shrink small outline package; 16 leads; body width 3.9 mm; lead pitch 0.635 mm SOT519-1



**DIMENSIONS** (mm are the original dimensions)

| UNIT | A max. | A <sub>1</sub> | A <sub>2</sub> | A <sub>3</sub> | b <sub>p</sub> | c            | D <sup>(1)</sup> | E <sup>(1)</sup> | e     | H <sub>E</sub> | L | L <sub>p</sub> | v   | w    | y    | Z <sup>(1)</sup> | θ        |
|------|--------|----------------|----------------|----------------|----------------|--------------|------------------|------------------|-------|----------------|---|----------------|-----|------|------|------------------|----------|
| mm   | 1.73   | 0.25<br>0.10   | 1.55<br>1.40   | 0.25           | 0.31<br>0.20   | 0.25<br>0.18 | 5.0<br>4.8       | 4.0<br>3.8       | 0.635 | 6.2<br>5.8     | 1 | 0.89<br>0.41   | 0.2 | 0.18 | 0.09 | 0.18<br>0.05     | 8°<br>0° |

**Note**

1. Plastic or metal protrusions of 0.2 mm maximum per side are not included.

| OUTLINE VERSION | REFERENCES |       |       |  | EUROPEAN PROJECTION | ISSUE DATE             |
|-----------------|------------|-------|-------|--|---------------------|------------------------|
|                 | IEC        | JEDEC | JEITA |  |                     |                        |
| SOT519-1        |            |       |       |  |                     | -99-05-04-<br>03-02-18 |

Fig. 19. Package outline SOT519-1 (SSOP16)

TSSOP14: plastic thin shrink small outline package; 14 leads; body width 4.4 mm

SOT402-1

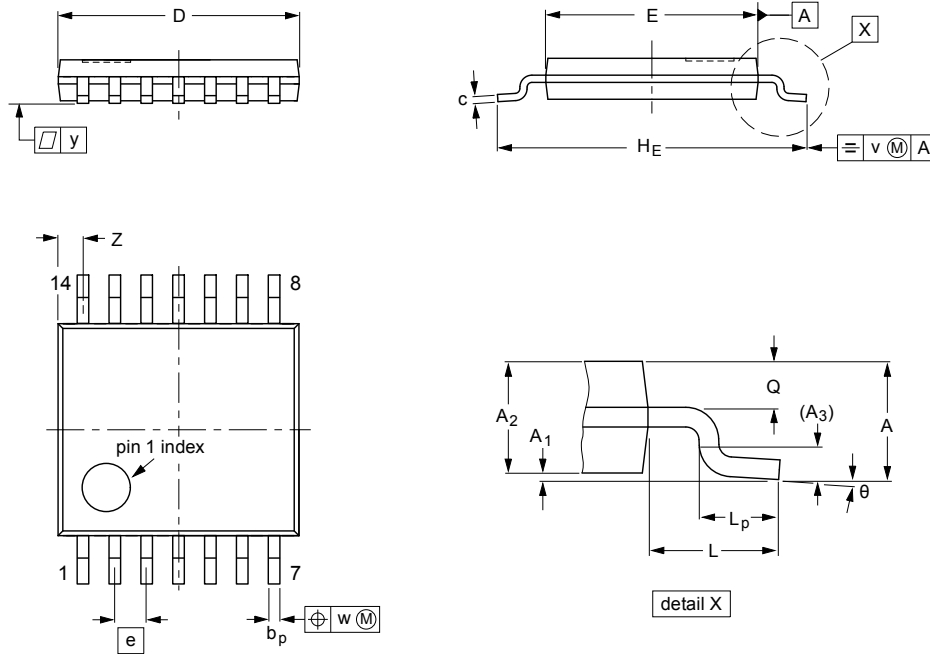

**DIMENSIONS (mm are the original dimensions)**

| UNIT | A <sub>max.</sub> | A <sub>1</sub> | A <sub>2</sub> | A <sub>3</sub> | b <sub>p</sub> | c          | D <sup>(1)</sup> | E <sup>(2)</sup> | e    | H <sub>E</sub> | L | L <sub>p</sub> | Q          | v   | w    | y   | Z <sup>(1)</sup> | θ        |
|------|-------------------|----------------|----------------|----------------|----------------|------------|------------------|------------------|------|----------------|---|----------------|------------|-----|------|-----|------------------|----------|
| mm   | 1.1               | 0.15<br>0.05   | 0.95<br>0.80   | 0.25           | 0.30<br>0.19   | 0.2<br>0.1 | 5.1<br>4.9       | 4.5<br>4.3       | 0.65 | 6.6<br>6.2     | 1 | 0.75<br>0.50   | 0.4<br>0.3 | 0.2 | 0.13 | 0.1 | 0.72<br>0.38     | 8°<br>0° |

**Notes**

1. Plastic or metal protrusions of 0.15 mm maximum per side are not included.
2. Plastic interlead protrusions of 0.25 mm maximum per side are not included.

| OUTLINE VERSION | REFERENCES |        |       |  | EUROPEAN PROJECTION | ISSUE DATE           |
|-----------------|------------|--------|-------|--|---------------------|----------------------|
|                 | IEC        | JEDEC  | JEITA |  |                     |                      |
| SOT402-1        |            | MO-153 |       |  |                     | 99-12-27<br>03-02-18 |

**Fig. 20. Package outline SOT402-1 (TSSOP14)**

DHVQFN14: plastic dual in-line compatible thermal enhanced very thin quad flat package; no leads; 14 terminals; body 2.5 x 3 x 0.85 mm

SOT762-1

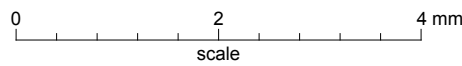
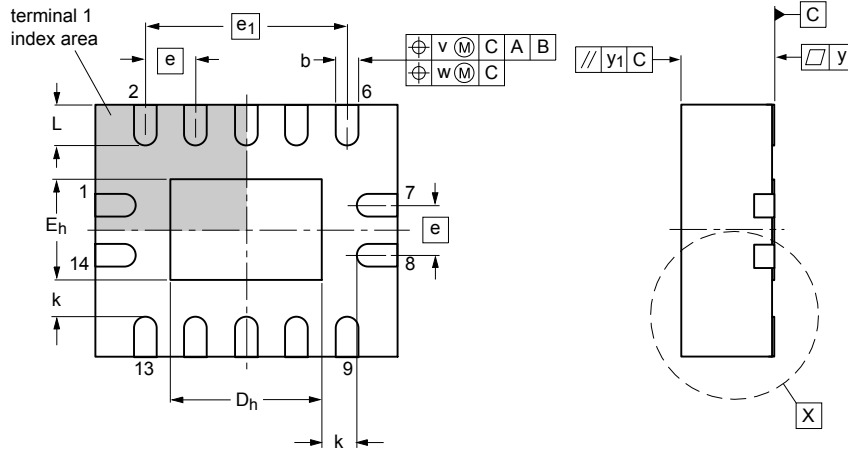
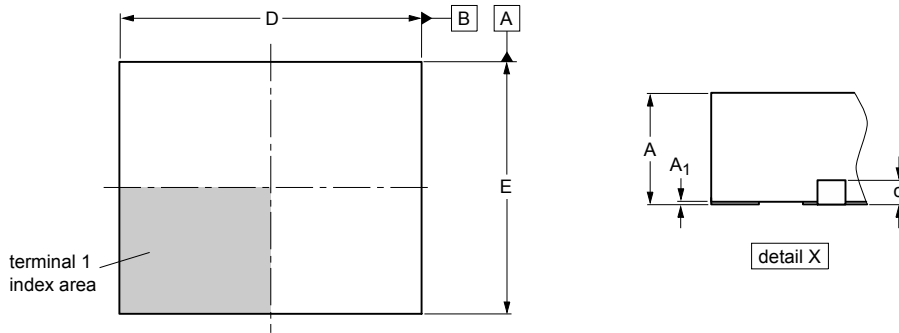

Dimensions (mm are the original dimensions)

| Unit | A <sup>(1)</sup> | A <sub>1</sub> | b    | c   | D <sup>(1)</sup> | D <sub>h</sub> | E <sup>(1)</sup> | E <sub>h</sub> | e   | e <sub>1</sub> | k   | L   | v   | w    | y    | y <sub>1</sub> |
|------|------------------|----------------|------|-----|------------------|----------------|------------------|----------------|-----|----------------|-----|-----|-----|------|------|----------------|
| max  | 1                | 0.05           | 0.30 |     | 3.1              | 1.65           | 2.6              | 1.15           |     |                |     | 0.5 |     |      |      |                |
| nom  |                  | 0.02           | 0.25 | 0.2 | 3.0              | 1.50           | 2.5              | 1.00           | 0.5 | 2              |     | 0.4 | 0.1 | 0.05 | 0.05 | 0.1            |
| min  |                  | 0.00           | 0.18 |     | 2.9              | 1.35           | 2.4              | 0.85           |     |                | 0.2 | 0.3 |     |      |      |                |

Note

1. Plastic or metal protrusions of 0.075 mm maximum per side are not included.

sot762-1\_po

| Outline version | References |        |       |  | European projection | Issue date             |
|-----------------|------------|--------|-------|--|---------------------|------------------------|
|                 | IEC        | JEDEC  | JEITA |  |                     |                        |
| SOT762-1        |            | MO-241 |       |  |                     | -15-04-10-<br>15-05-05 |

Fig. 21. Package outline SOT762-1 (DHVQFN14)

## 12. Abbreviations

Table 12. Abbreviations

| Acronym | Description                             |
|---------|---|
| CDM     | Charged Device Model                    |
| CMOS    | Complementary Metal-Oxide Semiconductor |
| DUT     | Device Under Test                       |
| ESD     | ElectroStatic Discharge                 |
| HBM     | Human Body Model                        |
| MM      | Machine Model                           |

## 13. Revision history

Table 13. Revision history

| Document ID     | Release date  | Data sheet status  | Change notice | Supersedes      |
|-----------------|---|--------------------|---------------|-----------------|
| 74CBTLV3125 v.5 | 20181008  | Product data sheet | -             | 74CBTLV3125 v.4 |
| Modifications:  | <ul style="list-style-type: none"> <li>The format of this data sheet has been redesigned to comply with the identity guidelines of Nexperia.</li> <li>Legal texts have been adapted to the new company name where appropriate.</li> </ul> |                    |               |                 |
| 74CBTLV3125 v.4 | 20161109  | Product data sheet | -             | 74CBTLV3125 v.3 |
| Modifications:  | <ul style="list-style-type: none"> <li><a href="#">Section 10.2</a> added.</li> </ul>   |                    |               |                 |
| 74CBTLV3125 v.3 | 20111215  | Product data sheet | -             | 74CBTLV3125 v.2 |
| Modifications:  | <ul style="list-style-type: none"> <li>Legal pages updated.</li> </ul>  |                    |               |                 |
| 74CBTLV3125 v.2 | 20110104  | Product data sheet | -             | 74CBTLV3125 v.1 |
| 74CBTLV3125 v.1 | 20100108  | Product data sheet | -             | -               |

## 14. Legal information

### Data sheet status

| Document status [1][2]         | Product status [3] | Definition  |
|--------------------------------|--------------------|---|
| Objective [short] data sheet   | Development        | This document contains data from the objective specification for product development. |
| Preliminary [short] data sheet | Qualification      | This document contains data from the preliminary specification.                       |
| Product [short] data sheet     | Production         | This document contains the product specification.                                     |

- [1] Please consult the most recently issued document before initiating or completing a design.
- [2] The term 'short data sheet' is explained in section "Definitions".
- [3] The product status of device(s) described in this document may have changed since this document was published and may differ in case of multiple devices. The latest product status information is available on the internet at <https://www.nexperia.com>.

### Definitions

**Draft** — The document is a draft version only. The content is still under internal review and subject to formal approval, which may result in modifications or additions. Nexperia does not give any representations or warranties as to the accuracy or completeness of information included herein and shall have no liability for the consequences of use of such information.

**Short data sheet** — A short data sheet is an extract from a full data sheet with the same product type number(s) and title. A short data sheet is intended for quick reference only and should not be relied upon to contain detailed and full information. For detailed and full information see the relevant full data sheet, which is available on request via the local Nexperia sales office. In case of any inconsistency or conflict with the short data sheet, the full data sheet shall prevail.

**Product specification** — The information and data provided in a Product data sheet shall define the specification of the product as agreed between Nexperia and its customer, unless Nexperia and customer have explicitly agreed otherwise in writing. In no event however, shall an agreement be valid in which the Nexperia product is deemed to offer functions and qualities beyond those described in the Product data sheet.

### Disclaimers

**Limited warranty and liability** — Information in this document is believed to be accurate and reliable. However, Nexperia does not give any representations or warranties, expressed or implied, as to the accuracy or completeness of such information and shall have no liability for the consequences of use of such information. Nexperia takes no responsibility for the content in this document if provided by an information source outside of Nexperia.

In no event shall Nexperia be liable for any indirect, incidental, punitive, special or consequential damages (including - without limitation - lost profits, lost savings, business interruption, costs related to the removal or replacement of any products or rework charges) whether or not such damages are based on tort (including negligence), warranty, breach of contract or any other legal theory.

Notwithstanding any damages that customer might incur for any reason whatsoever, Nexperia's aggregate and cumulative liability towards customer for the products described herein shall be limited in accordance with the Terms and conditions of commercial sale of Nexperia.

**Right to make changes** — Nexperia reserves the right to make changes to information published in this document, including without limitation specifications and product descriptions, at any time and without notice. This document supersedes and replaces all information supplied prior to the publication hereof.

**Suitability for use** — Nexperia products are not designed, authorized or warranted to be suitable for use in life support, life-critical or safety-critical systems or equipment, nor in applications where failure or malfunction of an Nexperia product can reasonably be expected to result in personal

injury, death or severe property or environmental damage. Nexperia and its suppliers accept no liability for inclusion and/or use of Nexperia products in such equipment or applications and therefore such inclusion and/or use is at the customer's own risk.

**Quick reference data** — The Quick reference data is an extract of the product data given in the Limiting values and Characteristics sections of this document, and as such is not complete, exhaustive or legally binding.

**Applications** — Applications that are described herein for any of these products are for illustrative purposes only. Nexperia makes no representation or warranty that such applications will be suitable for the specified use without further testing or modification.

Customers are responsible for the design and operation of their applications and products using Nexperia products, and Nexperia accepts no liability for any assistance with applications or customer product design. It is customer's sole responsibility to determine whether the Nexperia product is suitable and fit for the customer's applications and products planned, as well as for the planned application and use of customer's third party customer(s). Customers should provide appropriate design and operating safeguards to minimize the risks associated with their applications and products.

Nexperia does not accept any liability related to any default, damage, costs or problem which is based on any weakness or default in the customer's applications or products, or the application or use by customer's third party customer(s). Customer is responsible for doing all necessary testing for the customer's applications and products using Nexperia products in order to avoid a default of the applications and the products or of the application or use by customer's third party customer(s). Nexperia does not accept any liability in this respect.

**Limiting values** — Stress above one or more limiting values (as defined in the Absolute Maximum Ratings System of IEC 60134) will cause permanent damage to the device. Limiting values are stress ratings only and (proper) operation of the device at these or any other conditions above those given in the Recommended operating conditions section (if present) or the Characteristics sections of this document is not warranted. Constant or repeated exposure to limiting values will permanently and irreversibly affect the quality and reliability of the device.

**Terms and conditions of commercial sale** — Nexperia products are sold subject to the general terms and conditions of commercial sale, as published at <http://www.nexperia.com/profile/terms>, unless otherwise agreed in a valid written individual agreement. In case an individual agreement is concluded only the terms and conditions of the respective agreement shall apply. Nexperia hereby expressly objects to applying the customer's general terms and conditions with regard to the purchase of Nexperia products by customer.

**No offer to sell or license** — Nothing in this document may be interpreted or construed as an offer to sell products that is open for acceptance or the grant, conveyance or implication of any license under any copyrights, patents or other industrial or intellectual property rights.

**Export control** — This document as well as the item(s) described herein may be subject to export control regulations. Export might require a prior authorization from competent authorities.

**Non-automotive qualified products** — Unless this data sheet expressly states that this specific Nexperia product is automotive qualified, the product is not suitable for automotive use. It is neither qualified nor tested in accordance with automotive testing or application requirements. Nexperia accepts no liability for inclusion and/or use of non-automotive qualified products in automotive equipment or applications.

In the event that customer uses the product for design-in and use in automotive applications to automotive specifications and standards, customer (a) shall use the product without Nexperia's warranty of the product for such automotive applications, use and specifications, and (b) whenever customer uses the product for automotive applications beyond Nexperia's specifications such use shall be solely at customer's own risk, and (c) customer fully indemnifies Nexperia for any liability, damages or failed product claims resulting from customer design and use of the product for automotive applications beyond Nexperia's standard warranty and Nexperia's product specifications.

**Translations** — A non-English (translated) version of a document is for reference only. The English version shall prevail in case of any discrepancy between the translated and English versions.

### Trademarks

Notice: All referenced brands, product names, service names and trademarks are the property of their respective owners.



## Contents

---

|  |           |
|--|-----------|
| <b>1. General description</b> .....              | <b>1</b>  |
| <b>2. Features and benefits</b> .....            | <b>1</b>  |
| <b>3. Ordering information</b> .....             | <b>2</b>  |
| <b>4. Functional diagram</b> .....               | <b>2</b>  |
| <b>5. Pinning information</b> .....              | <b>3</b>  |
| 5.1. Pinning.....                                | 3         |
| 5.2. Pin description.....                        | 3         |
| <b>6. Functional description</b> .....           | <b>3</b>  |
| <b>7. Limiting values</b> .....                  | <b>4</b>  |
| <b>8. Recommended operating conditions</b> ..... | <b>4</b>  |
| <b>9. Static characteristics</b> .....           | <b>5</b>  |
| 9.1. Test circuits.....                          | 5         |
| 9.2. ON resistance.....                          | 6         |
| 9.3. ON resistance test circuit and graphs.....  | 6         |
| <b>10. Dynamic characteristics</b> .....         | <b>8</b>  |
| 10.1. Waveforms and test circuit.....            | 9         |
| 10.2. Additional dynamic characteristics.....    | 11        |
| <b>11. Package outline</b> .....                 | <b>12</b> |
| <b>12. Abbreviations</b> .....                   | <b>15</b> |
| <b>13. Revision history</b> .....                | <b>15</b> |
| <b>14. Legal information</b> .....               | <b>16</b> |

---

© Nexperia B.V. 2018. All rights reserved

For more information, please visit: <http://www.nexperia.com>  
For sales office addresses, please send an email to: [salesaddresses@nexperia.com](mailto:salesaddresses@nexperia.com)  
**Date of release: 8 October 2018**

---