

# ∅ 172×150×51 mm

San Ace 172L 9L type   

Sidecut type



## General Specifications

- Material ..... Frame: Aluminum, Impeller: Plastic (Flammability: UL 94V-1)
- Expected life ..... See the table below. (L10 life: 90% survival rate for continuous operation in free air at 60°C, rated voltage)
- Motor protection function ..... Locked rotor burnout protection, Reverse polarity protection  
For details, please refer to p. 547.
- Dielectric strength ..... 50/60 Hz, 500 VAC, for 1 minute (between lead wire conductors and frame)
- Insulation resistance ..... 10 MΩ or more with a 500 VDC megger (between lead wire conductors and frame)
- Sound pressure level (SPL) ..... At 1 m away from the air inlet
- Storage temperature ..... -30 to +70°C (Non-condensing)
- Lead wire ..... ⊕Red ⊖Black or Blue (Sensor) Yellow
- Mass ..... 760 g

## Specifications

The models listed below **have pulse sensors.**

Model no.	Rated voltage [V]	Operating voltage range [V]	Rated current [A]	Rated input [W]	Rated speed [min <sup>-1</sup> ]	Max. airflow [m <sup>2</sup> /min] [CFM]	Max. static pressure [Pa] [inchH <sub>2</sub> O]	SPL [dB (A)]	Operating temperature [°C]	Expected life [h]
109L5712H501	12	10.2 to 13.8	1.2	14.4	3050	6.4 226	137.2 0.551	52	-20 to +70	100000/60°C
109L5712M501			0.48	5.76	2000	4.2 148	67.6 0.271	41		
109L5724H501	24	20.4 to 27.6	0.58	13.92	3050	6.4 226	137.2 0.551	52		
109L5724M501			0.2	4.8	2000	4.2 148	67.6 0.271	41		
109L5748H501	48	40.8 to 55.2	0.28	13.44	3050	6.4 226	137.2 0.551	52		
109L5748M501			0.11	5.28	2000	4.2 148	67.6 0.271	41		

The following sensor and control options are available for selection.

Available for all models. Without sensor Lock sensor

## Airflow - Static Pressure Characteristics

**109L5712H501** With pulse sensor

Operating voltage range

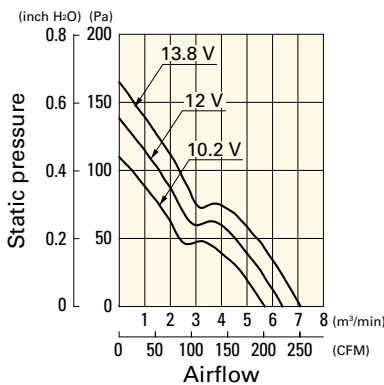

**109L5712M501** With pulse sensor

Operating voltage range

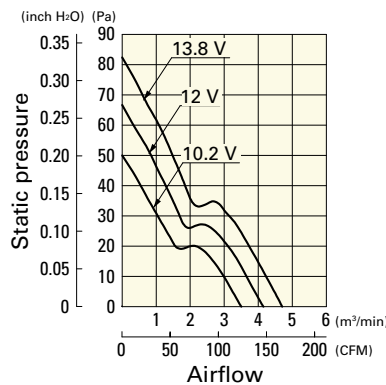

**109L5724H501** With pulse sensor

Operating voltage range

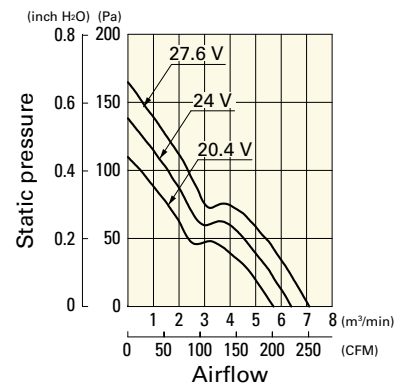

## Airflow - Static Pressure Characteristics

**109L5724M501** With pulse sensor

Operating voltage range

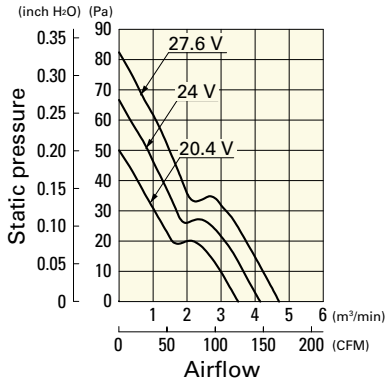

**109L5748H501** With pulse sensor

Operating voltage range

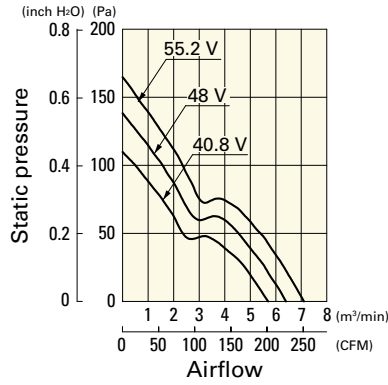

**109L5748M501** With pulse sensor

Operating voltage range

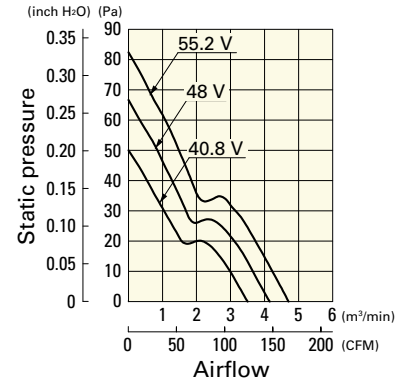

## Dimensions (unit: mm)

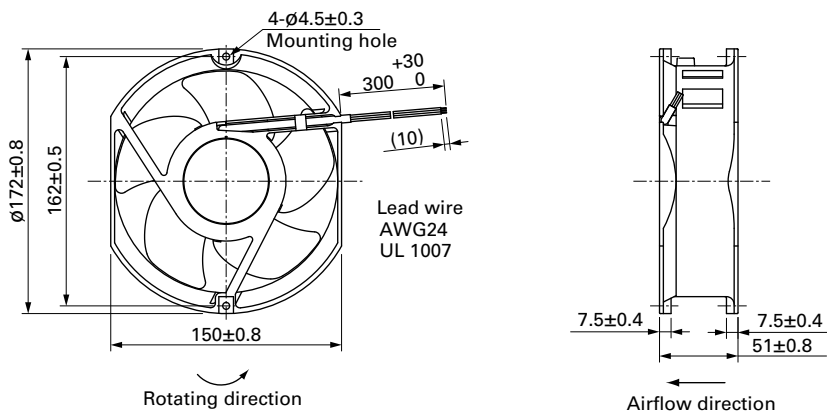

## Reference Dimensions of Mounting Holes and Vent Opening (unit: mm)



## Options

Finger guards

page: p. 534

Model no.: 109-319E, 109-319H, 109-320