

Propeller Education Kit Labs

Fundamentals

Version 1.1

By Andy Lindsay

PARALLAX 

WARRANTY

Parallax Inc. warrants its products against defects in materials and workmanship for a period of 90 days from receipt of product. If you discover a defect, Parallax Inc. will, at its option, repair or replace the merchandise, or refund the purchase price. Before returning the product to Parallax, call for a Return Merchandise Authorization (RMA) number. Write the RMA number on the outside of the box used to return the merchandise to Parallax. Please enclose the following along with the returned merchandise: your name, telephone number, shipping address, and a description of the problem. Parallax will return your product or its replacement using the same shipping method used to ship the product to Parallax.

14-DAY MONEY BACK GUARANTEE

If, within 14 days of having received your product, you find that it does not suit your needs, you may return it for a full refund. Parallax Inc. will refund the purchase price of the product, excluding shipping/handling costs. This guarantee is void if the product has been altered or damaged. See the Warranty section above for instructions on returning a product to Parallax.

COPYRIGHTS AND TRADEMARKS

This documentation is copyright © 2006-2009 by Parallax Inc. By downloading or obtaining a printed copy of this documentation or software you agree that it is to be used exclusively with Parallax products. Any other uses are not permitted and may represent a violation of Parallax copyrights, legally punishable according to Federal copyright or intellectual property laws. Any duplication of this documentation for commercial uses is expressly prohibited by Parallax Inc. Duplication for educational use is permitted, subject to the following Conditions of Duplication: Parallax Inc. grants the user a conditional right to download, duplicate, and distribute this text without Parallax's permission. This right is based on the following conditions: the text, or any portion thereof, may not be duplicated for commercial use; it may be duplicated only for educational purposes when used solely in conjunction with Parallax products, and the user may recover from the student only the cost of duplication.

This text is available in printed format from Parallax Inc. Because we print the text in volume, the consumer price is often less than typical retail duplication charges.

Propeller, Penguin, and Spin are trademarks of Parallax Inc. BASIC Stamp, Stamps in Class, Boe-Bot, SumoBot, Scribbler, Toddler, and SX-Key are registered trademarks of Parallax, Inc. If you decide to use any trademarks of Parallax Inc. on your web page or in printed material, you must state that (trademark) is a (registered) trademark of Parallax Inc." upon the first appearance of the trademark name in each printed document or web page. Other brand and product names herein are trademarks or registered trademarks of their respective holders.

ISBN 13: 9-781928-982500

1.1.0-09.03.06-HKTP

DISCLAIMER OF LIABILITY

Parallax Inc. is not responsible for special, incidental, or consequential damages resulting from any breach of warranty, or under any legal theory, including lost profits, downtime, goodwill, damage to or replacement of equipment or property, or any costs of recovering, reprogramming, or reproducing any data stored in or used with Parallax products. Parallax Inc. is also not responsible for any personal damage, including that to life and health, resulting from use of any of our products. You take full responsibility for your Propeller microcontroller application, no matter how life-threatening it may be.

INTERNET DISCUSSION LISTS

We maintain active web-based discussion forums for people interested in Parallax products. These lists are accessible from www.parallax.com via the Support → Discussion Forums menu. These are the forums that we operate from our web site:

- [Propeller chip](#) – This list is specifically for our customers using Propeller chips and products.
- [BASIC Stamp](#) – This list is widely utilized by engineers, hobbyists and students who share their BASIC Stamp projects and ask questions.
- [Stamps in Class](#)[®] – Created for educators and students, subscribers discuss the use of the Stamps in Class series of tutorials in their courses. The list provides an opportunity for both students and educators to ask questions and get answers.
- [Parallax Educators](#) – A private forum exclusively for educators and those who contribute to the development of Stamps in Class and Propeller Education materials. Parallax created this group to obtain feedback on our educational materials and to provide a place for educators to develop and share classroom resources.
- [Robotics](#) – Designed for Parallax robots, this forum is intended to be an open dialogue for robotics enthusiasts. Topics include assembly, source code, expansion, and manual updates. The Boe-Bot[®], Toddler[®], SumoBot[®], Scribbler[®] and Penguin[™] robots are discussed here.
- [SX Microcontrollers and SX-Key](#) – Discussion of programming the SX microcontroller with Parallax assembly language SX-Key[®] tools and 3rd party BASIC and C compilers.
- [Javelin Stamp](#) – Discussion of application and design using the Javelin Stamp, a Parallax module that is programmed using a subset of Sun Microsystems' Java[®] programming language.

ERRATA

While great effort is made to assure the accuracy of our texts, errors may still exist. If you find an error, please let us know by sending an email to editor@parallax.com. We continually strive to improve all of our educational materials and documentation, and frequently revise our texts. Occasionally, an errata sheet with a list of known errors and corrections for a given text will be posted to our web site, www.parallax.com. Please check the individual product page's free downloads for an errata file.

Table of Contents

PREFACE..... 5

1: PROPELLER MICROCONTROLLER & LABS OVERVIEW 7

 The Propeller Microcontroller 7

 The Propeller Education Kit 12

 The Propeller Education Kit Labs..... 14

2: SOFTWARE, DOCUMENTATION & RESOURCES 17

 Download Software and Documentation..... 17

 Install the Parallax Serial Terminal..... 18

 Useful Web Sites..... 18

 Tech Support Resources 18

3: SETUP AND TESTING LAB FOR 40-PIN DIP PE PLATFORM 19

 The PE Platform 19

 Procedure Overview..... 23

 Inventory Equipment and Parts..... 24

 Assemble the Breadboards..... 25

 Set up PE Platform Wiring and Voltage Regulators..... 27

 Test the PE Platform Wiring..... 29

 Socket the Propeller Chip and EEPROM..... 30

 Load a Test Program and Test the I/O Pins 32

 Before Changing or Adjusting Circuits 37

 Troubleshooting for the 40-Pin DIP PE Platform Setup..... 37

4: I/O AND TIMING BASICS LAB..... 43

 Parts List and Schematic 43

 Propeller Nomenclature..... 44

 Lights on with Direction and Output Register Bits..... 45

 I/O Pin Group Operations..... 47

 Reading an Input, Controlling an Output..... 48

 Timing Delays with the System Clock..... 49

 System Clock Configuration and Event Timing..... 51

 More Output Register Operations 53

 Conditional Repeat Commands 55

 Operations in Conditions and Pre and Post Operator Positions..... 56

 Some Operator Vocabulary..... 58

 Shifting LED Display..... 59

 Variable Example 60

 Timekeeping Applications 62

 Study Time 64

5: METHODS AND COGS LAB..... 67

 Introduction..... 67

 Parts List and Schematic 67

 Defining a Method's Behavior with Local Variables 68

 Calling a Method 68

 Parameter Passing..... 69

 Cog ID Indexing..... 76

 Study Time 78

6: OBJECTS LAB 81

Table of Contents

Introduction	81
Equipment, Parts, Schematic	82
Method Call Review	83
Calling Methods in Other Objects with Dot Notation	83
Objects that Launch Processes into Cogs.....	86
Conventions for Start and Stop Methods in Library Objects	90
Documentation Comments	90
Public vs. Private methods	93
Multiple Object Instances.....	94
Propeller Chip – PC Terminal Communication.....	95
FullDuplexSerial and Other Library Objects	100
Sending Values from Parallax Serial Terminal to the Propeller Chip	103
Terminal I/O Pin Input State Display	105
Terminal LED Output Control	107
The DAT Block and Address Passing	108
The Float and FloatString Objects.....	110
Objects that Use Variable Addresses	111
Passing Starting Addresses to Objects that Work with Variable Lists.....	114
Study Time.....	116
7: COUNTER MODULES AND CIRCUIT APPLICATIONS LAB	121
Introduction	121
How Counter Modules Work.....	122
Measuring RC Decay with a Positive Detector Mode.....	122
D/A Conversion – Controlling LED Brightness with DUTY Modes	129
Special Purpose Registers	134
Generating Piezospeaker Tones with NCO Mode.....	137
Applications - IR Object and Distance Detection with NCO and DUTY Modes	147
Counting Transitions with POSEDGE and NEGEDGE Modes	153
PWM with the NCO Modes.....	156
Probe and Display PWM – Add an Object, Cog and Pair of Counters.....	160
PLL Modes for High-Frequency Applications	166
Metal Detection with PLL and POS Detector Modes and an LC Circuit.....	171
Study Time.....	180
APPENDIX A: OBJECT CODE LISTINGS	187
FullDuplexSerialPlus.spin	187
SquareWave.spin	193
APPENDIX B: STUDY SOLUTIONS	195
I/O and Timing Basics Lab Study Solutions	195
Methods and Cogs Lab Study Solutions	201
Objects Lab Study Solutions.....	203
Counter Modules and Circuit Applications Lab Study Solutions	209
APPENDIX C: PE KIT COMPONENTS LISTING	219
APPENDIX D: PROPELLER MICROCONTROLLER BLOCK DIAGRAM.....	221
APPENDIX E: LM2940CT-5.0 CURRENT LIMIT CALCULATIONS.....	222
INDEX	224

Preface

Since the Propeller chip comes in a 40-Pin DIP package, a pluggable breadboard kit for the Propeller chip made a lot of sense. The support circuits for the Propeller chip, including EEPROM program memory, voltage regulators, crystal oscillator, and Propeller Plug programming tool are all also available in versions that can be plugged into a breadboard, so why not? It also makes a great deal of sense from the college and university lab standpoint. Provide a simple kit that students can afford, that is reusable, with a microcontroller that excels in a multitude of electronics, robotics, and embedded systems projects. With that in mind, the PE DIP Plus Kit was put together, as a bag that includes the Propeller microcontroller, “plus” all the other parts you might need to make it work.

The PE DIP Plus Kit made sense for folks who have already have breadboards and some experience, but what about a student who maybe just completed the Stamps in Class *What’s a Microcontroller* tutorial, and is interested in approaching the Propeller chip as a kit and tutorial as well? With this student in mind, another bag of parts was assembled, along with a series of activities that put the parts in the bag to work with the Propeller microcontroller. The bag of parts ended up with the name PE Project Parts, and the activities became the PE Kit Labs.

The PE Kit Labs in this text are written primarily for college and university students with some previous programming and electronics experience, preferably with microcontrollers. Subjects introduced include:

- Microcontroller basics such as I/O control and timing with the system clock
- Programming topics such as operators, method calls, and objects, and variable addresses
- Programmed multiprocessor control
- Microcontroller-circuit interactions with indicator lights, pushbuttons, circuits that sense the environment and can be measured with RC decay, frequency circuits (speakers), and frequency selective circuits
- Advanced topics include utilizing counter modules to perform tasks in the background

This collection of PE Kit Labs is intended give the reader a good start with programming the Propeller chip and using it in projects. However, this book is just a start. Introducing all aspects of the Propeller microcontroller with PE Kit Labs would take several such books, so additional labs are available online. More labs and applications will be posted periodically.

This text also includes pointers to the wealth of information available for the Propeller chip in the Propeller Manual, Propeller Datasheet, Propeller Forum, and Propeller Object Exchange, as well as examples of using these resources. The reader is especially encouraged to utilize the Propeller Manual as a reference while going through these labs. The Propeller Manual’s contents and index will provide references to more information about any topic introduced in these labs.

The Propeller Chip Forum at forums.parallax.com has a Propeller Education Kit Labs sticky-thread with links to discussions about each lab. The reader is encouraged to utilize this resource for posting questions about topics in the PE Kit Labs as well as comments and suggestions. Parallax collects this feedback and incorporates it into future revisions of each lab. Also, if you (or your students) prototyped something cool with the PE Kit, by all means, post your documented project to the forums so that others can see what you did and how you did it.

Acknowledgements

Parallaxians:

- Author: Andy Lindsay, Applications Engineer
- Cover art: Jennifer Jacobs, Art Director
- Editing: Stephanie Lindsay, Technical Editor
- Illustrations: Andy Lindsay, with help from Rich Allred, Manufacturing Manager
- Photography: Rich Allred
- Review: Jessica Uelmen, Education Associate

Parallax Community – thanks to:

- Aaron Klapheck for commented code illustrating cog variable bookkeeping in the Advanced Topic: Inside `Start` and `Stop` methods section of the Objects Lab.
- Engineering students at University of California Davis and California State University Sacramento who used the PE Kit in their projects and submitted great questions and bug reports.
- Steve Nicholson for his incisive and thorough review of earlier drafts of the PE Kit Labs.

1: Propeller Microcontroller & Labs Overview

This chapter provides an abbreviated overview of the Propeller Microcontroller and some introductory information about the Propeller Education Kit and Labs. More detailed information about the Propeller microcontroller, its architecture, and programming languages can be found in the *Propeller Manual* and *Propeller Datasheet*. Both are available from the Downloads link at www.parallax.com/Propeller.

The Propeller Microcontroller

The Propeller Microcontroller in Figure 1-1 (a) is a single chip with eight built-in 32-bit processors, called *cogs*. Cogs can be programmed to function simultaneously, both independently and cooperatively with other cogs. In other words, cogs can all function simultaneously, but whether they function independently or cooperatively is defined by the program. Groups of cogs can be programmed to work together, while others work on independent tasks.

A configurable system clock supplies all the cogs with the same clock signal (up to 80 MHz). Figure 1-1 (b) shows how each cog takes turns at the option for exclusive read/write access of the Propeller chip's main memory via the *Hub*. Exclusive read/write access is important because it means that two cogs cannot try to modify the same item in memory at the same instance. It also prevents one cog from reading a particular address in memory at the same time another cog is writing to it. So, exclusive access ensures that there are never any memory access conflicts that could corrupt data.

Figure 1-1: Propeller Microcontroller Packages and Hub and Cog Interaction

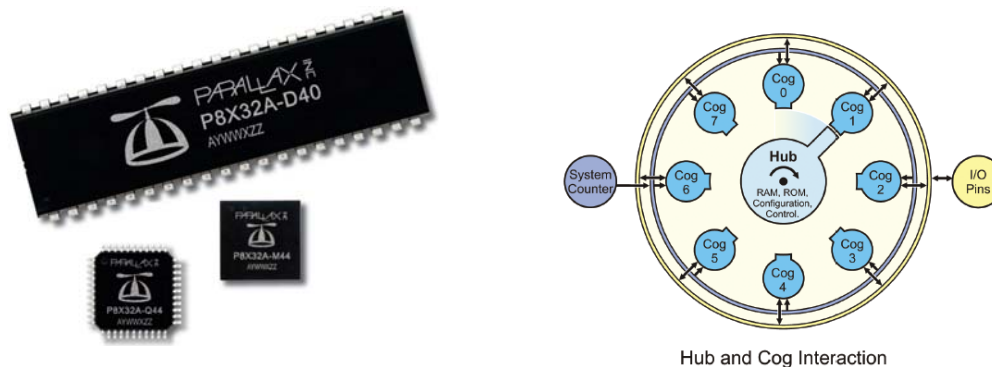

(a) Propeller microcontrollers in 40-pin DIP, TSOP and QFN packages

(b) Excerpt from Propeller Block Diagram describing Hub and Cog interaction. See Appendix D: Propeller Microcontroller Block Diagram

32 KB of the Propeller chip's main memory is RAM used for program and data storage, and another 32 KB is ROM, and stores useful tables such as log, antilog, sine, and graphic character tables. The ROM also stores boot loader code that cog 0 uses at startup and interpreter code that any cog can use to fetch and execute application code from main memory. Each cog also has the ability to read the states of any or all of the Propeller chip's 32 I/O pins at any time, as well as set their directions and output states at any time.

Propeller Microcontroller & Labs Overview

The Propeller chip's unique multiprocessing design makes a variety of otherwise difficult microcontroller applications relatively simple. For example, processors can be assigned to audio inputs, audio outputs, mouse, keyboard, and maybe a TV or LCD display to create a microcontroller based computer system, with processors left over to work on more conventional tasks such as monitoring inputs and sensors and controlling outputs and actuators. Figure 1-2 (a) shows a Propeller chip-generated video image that could be used in that this kind of application. The Propeller also excels as a robotic controller, with the ability to assign processors to tasks such as PWM DC motor control, video processing, sensor array monitoring, and high speed communication with nearby robots and/or PCs. Figure 1-2 (b) shows an example of a Propeller controlled balancing robot with video sensor. The initial prototype was developed with a Propeller Education Kit.

Although the Propeller chip is very powerful, that doesn't mean it is difficult to use. The Propeller chip also comes in handy for simple projects involving indicator lights, buttons, sensors, speakers, actuators, and smaller displays found in common product designs. You will see examples of such simple circuits in the following Propeller Education Kit Labs.

Figure 1-2: Application Examples



(a) Propeller microcontroller generated graphic TV display. This application also uses a standard PS/2 mouse to control the graphics (not shown).



(b) Hanno Sander's balancing robot, initial prototype developed with the Propeller Education Kit and ViewPort software. Photo courtesy of mydancebot.com.

Applications with the Propeller Chip

Programs for the Propeller chip are written with PC software and then loaded into the Propeller chip, typically via a USB connection. The languages supported by Parallax' free Propeller Tool software include a high-level language called Spin, and a low-level assembly language. Applications developed in Spin language can optionally contain assembly language code. These applications are stored on your PC as .spin files.



Other programming languages have been developed for programming the Propeller chip. Some are free and available through resources like the Parallax forums and Source Forge; others are available for purchase or free in a limited version through the Parallax web site and other companies that sell compilers.

Before a cog can start executing a Spin application, it has to first load an Interpreter from the Propeller chip's ROM (Figure 1-3 a). Spin applications get stored in main memory's RAM as tokens, which the interpreter code makes the cog repeatedly fetch and execute (Figure 1-3 b & c). A few

1: Propeller Microcontroller & Labs Overview

examples of actions the cog might take based on the token values are shown in Figure 1-3 (c). They include read/writes to configuration registers, variables, and I/O pins as well as reads from ROM. Cogs can also execute the machine codes generated by assembly language. As shown in Figure 1-4, these machine codes get loaded into the cog's 2 KB (512 longs) of RAM and executed at a very high speed, up to 20 million instructions per second (MIPS). Cog RAM not used by machine instructions can also provide high speed memory for the cog with four clock cycles (50 ns at 80 MHz) per read/write.

Figure 1-3: Cog Interpreting Spin Language

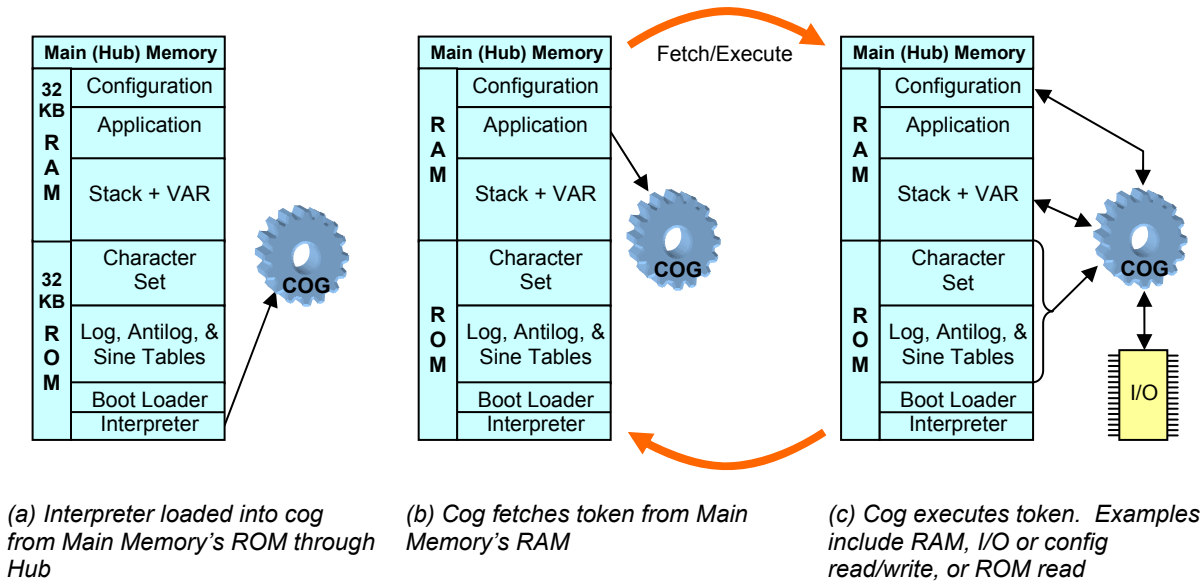

A cog executing assembly language can also access the Propeller chip's main memory through the Hub. The Hub grants main memory access to each cog every 16 clock cycles. Depending on when the cog decides to check with main memory, the access time could take anywhere from 7 to 22 clock cycles, which equates to a worst case memory access time of 275 ns at 80 MHz. After the first access, assembly code can synchronize with the cog's round-robin access window to main memory, keeping the subsequent access times fixed at 16 clock cycles (200 ns).

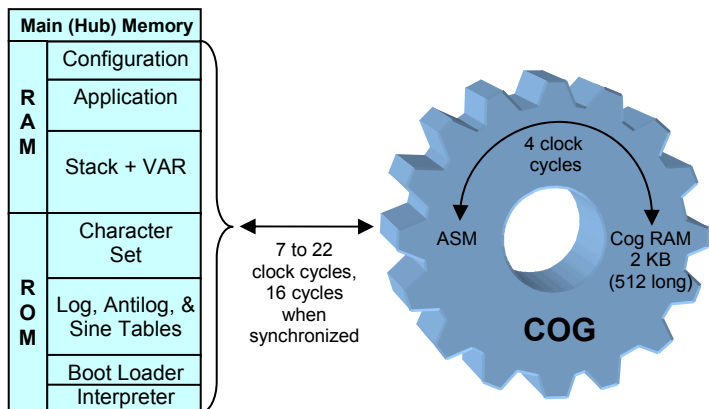

Figure 1-4: Cog Executing Assembly Language

Propeller Microcontroller & Labs Overview

Since each cog has access to the Propeller chip's RAM in main memory, they can work cooperatively by exchanging information. The Spin language has built-in features to pass the addresses of one or more variables used in code to other objects and cogs. This makes cog cooperation very simple. Code in one cog can launch code into another cog and pass it one or more variable addresses (see Figure 1-5). These variable addresses can then be used for the two cogs to exchange information.

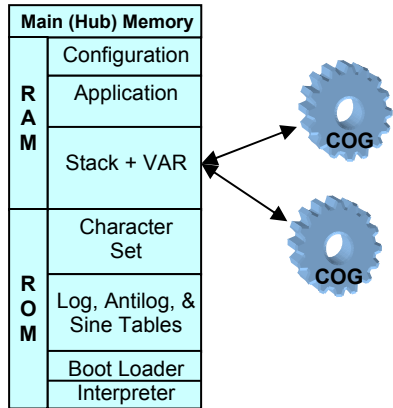

Figure 1-5: Two (or more) Cog's Working Cooperatively through Shared Memory

The Propeller chip's cogs are numbered cog 0 through cog 7. After the application is loaded into the Propeller chip, it loads an interpreter into cog 0, and this interpreter starts executing Spin code tokens stored in main memory. Commands in the Spin code can then launch blocks of code (which might be Spin or assembly language) into other cogs as shown in Figure 1-6. Code executed by the other cogs can launch still other cogs regardless of whether they are Spin or assembly, and both languages can also stop other cogs for the sake of ending unnecessary processes or even replacing them with different ones.

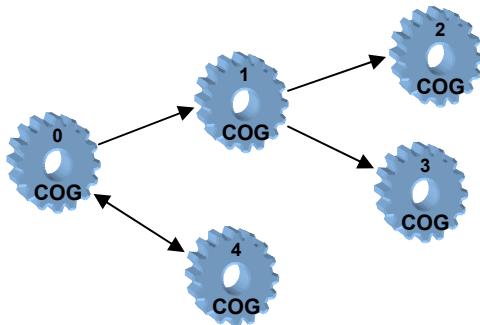

Figure 1-6: Cog Launching

Code in one cog launching other cogs, which can in turn launch others...

Cogs can also stop other cogs to free them up for other tasks.

Writing Application Code

Spin is an object-based programming language. Objects are designed to be the building blocks of an application, and each .spin file can be considered an object. While an application can be developed as a single object (one program), applications are more commonly a collection of objects. These objects can provide a variety of services. Examples include solutions for otherwise difficult coding problems, communication with peripheral devices, controlling actuators and monitoring sensors. These building block objects are distributed through the Propeller Object Exchange (obex.parallax.com) and also in the Propeller Tool software's Propeller Library folder. Incorporating these pre-written objects into an application can significantly reduce its complexity and development time.

1: Propeller Microcontroller & Labs Overview

Figure 1-7 shows how objects can be used as application building blocks, in this case, for a robot that maintains a distance between itself and a nearby object it senses. The application code in the Following Robot.spin object makes use of pre-written objects for infrared detection (IR Detector.spin), control system calculations (PID.spin), and motor drive (Servo Control.spin). Note that these pre-written objects can in turn use other objects to do their jobs. Instead of harvesting objects that do jobs for your application, you can also write them from scratch, and if they turn out to be useful, by all means, submit them for posting to the Propeller Object Exchange at obex.parallax.com.

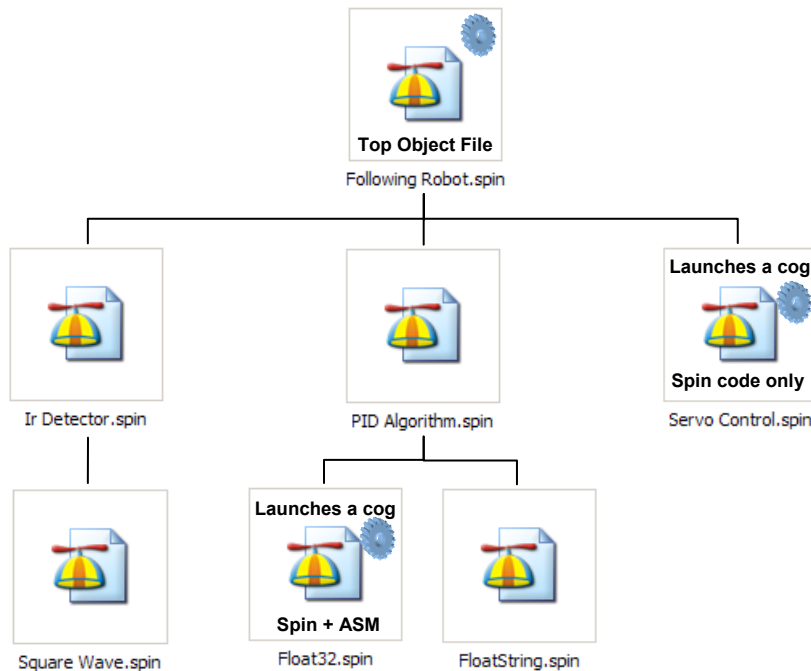

Figure 1-7: Object Building Blocks for Applications

In Figure 1-7, the Following Robot.spin object is called the top object file. This file has the first executable line of code where the Propeller chip starts when the application runs. In every case, cog 0 is launched and begins executing code from the top object. Our top object example, Following Robot.spin, contains code to initialize the three objects below it, making it the “parent object” of the three. Two of these three building blocks in turn initialize “child object” building blocks of their own. Two of the building block objects launch additional cogs to do their jobs, so a total of three cogs are used by this application. Regardless of whether a parent object launches a cog to execute Spin code or assembly code, the child objects have built-in Spin code and documentation that provide a simple interface for code in their parent objects to control/monitor them.

Though it is not shown in our example, recall from Figure 1-6 that an object can launch more than one cog. Also, an object can launch a process into a cog and then shut it down again to make it available to other objects. Although any object can actually start and stop any cog, it's a good practice to make stopping a cog the responsibility of the object that started it.

How the Propeller Chip Executes Code

The Parallax Propeller Tool software can be used to develop applications and load them into the Propeller chip. When an application is loaded into the Propeller chip, the Spin code is compiled into tokens and the optional assembly code is compiled into machine codes. The Propeller Tool then

Propeller Microcontroller & Labs Overview

transfers the application to the Propeller chip, typically with a serial-over-USB connection. The programmer can choose to load it directly into the Propeller chip's main RAM, or into an EEPROM (electrically erasable programmable read-only memory). As shown in Figure 1-8, if the program is loaded directly into RAM, the Propeller chip starts executing it immediately. If the program is loaded into an EEPROM, the Propeller chip copies this information to RAM before it starts executing.

Figure 1-8: Loading a Program into RAM or EEPROM

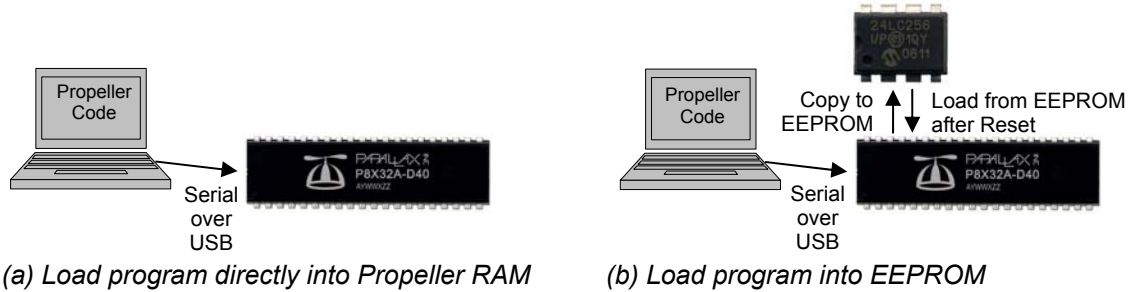

Loading programs from a PC into RAM takes around 1 second, whereas loading programs into EEPROM takes a few seconds (under 10 seconds for most). While loading programs into RAM can be a lot quicker for testing the results of changes during code development, programs should be loaded into EEPROM when the application is deployed, or if it is expected to restart after a power cycle or reset. Programs loaded into RAM are volatile, meaning they can be erased by a power interruption or by resetting the Propeller chip. In contrast, programs loaded into EEPROM are nonvolatile. After a power cycle or reset, the Propeller chip copies the program from EEPROM into RAM and then starts executing it again.

The Propeller Education Kit

The Propeller Education (PE) Kit is a complete Propeller microcontroller development system that can be used for projects and product prototypes. This kit also includes parts for projects that are documented by the PE Kit Labs. These labs will help you learn how to develop applications with the Propeller Microcontroller.



Figure 1-9: Propeller Education Kit (40-Pin DIP Version)

1: Propeller Microcontroller & Labs Overview

The PE Kit comes in two different versions: 40-pin DIP and PropStick USB. Both feature an arrangement of interlocking breadboards with the following parts mounted on them:

- Propeller microcontroller
- 5.0 V and 3.3 V voltage regulators
- EEPROM for non-volatile program storage
- 5.00 MHz external crystal oscillator for precise clock signal
- Reset button for manual program restarts
- LED power indicator
- 9 V battery-to-breadboard connector
- Serial to USB connection for downloads and bidirectional communication with the PC.

Collectively, the interlocking breadboards with Propeller microcontroller system mounted on it are referred to in this document as the PE Platform. The PE Platform with the 40-pin DIP kit is also shown in Figure 1-10 (a). With this platform, each part and circuit in the list above is plugged directly into the breadboard. Although this version of the PE Platform takes a little while to build and test, the advantage is that any given part can be replaced at a very low cost.

The PE Platform with the PropStick USB is shown in Figure 1-10 (a). The PropStick USB module is a small printed circuit board (PCB) with surface-mount versions of all the parts and circuits listed above (except the external 5 V regulator circuit). The PCB itself has pins so that it can be plugged into the breadboard. While this arrangement makes it quick wire up the PE Platform and get started, it can be relatively expensive to replace the PropStick USB rather than individual components if something gets damaged.

Figure 1-10: PE Kit Platforms

(a) 40-pin DIP Version

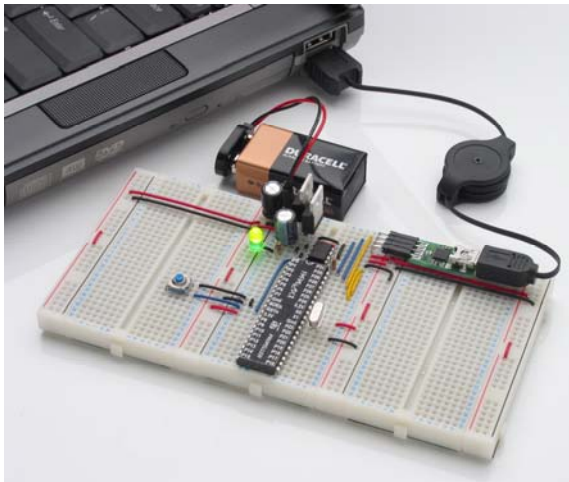

(b) PropStick USB Version

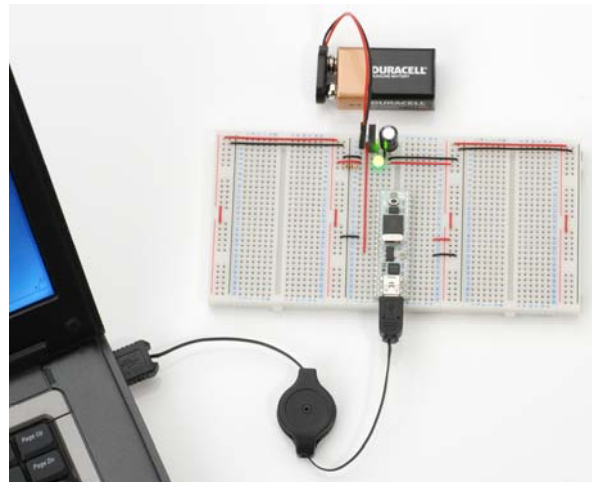

The Propeller Education Kit Labs

The Propeller Education Kit Labs include the ones printed in this text as well as additional labs and applications available for download from www.parallax.com. The labs in this text demonstrate how to connect circuits to the Propeller microcontroller and write programs that make the Propeller chip interact with the circuits. The programs also utilize the Spin programming language's features as well as the Propeller microcontroller's multiprocessing capabilities.

Prerequisites

These labs assume prior microcontroller experience. Although the Setup and Testing labs provide wiring diagrams, the rest do not. At a minimum, you should have experience building circuits from schematics as well as experience with some form of computer or microcontroller programming language.

	<p>Resources for Beginners: For introductions to building circuits, microcontroller programming, and much more "prior microcontroller experience", try either the BASIC Stamp Activity Kit or BASIC Stamp Discovery kit. Both kits have everything you'll need to get started, including a BASIC Stamp 2 microcontroller, project board, the introductory level <i>What's a Microcontroller?</i> text and parts for every activity. The <i>What's a Microcontroller?</i> text is also available for free PDF download from www.parallax.com, and both kits are available for purchase from the web site as well as from a variety of electronics retailers and distributors. To find a retailer or distributor near you, check the Distributors list under the Company category at the Parallax web site.</p>
---	--

PE Kit Labs in This Text

- **Software, Documentation & Resources** – Download Propeller software and documentation, and install the software.
- **Setup and Testing Lab for 40-Pin DIP PE Platform** – Hardware preparation. If you have the **PropStick USB Version** of the PE Kit, use its alternative Setup and Testing Lab. It is a free download from the 32306 product page at www.parallax.com.
- **I/O and Timing Basics Lab** – How to configure the Propeller chip's I/O pins, monitor input signals, transmit output signals, and coordinate when events happen based on the system clock.
- **Methods and Cogs** – How to write methods in Spin and optionally launch methods into one or more of the Propeller chip's cogs (processors).
- **Objects** – How use pre-written objects to simplify coding tasks, and how to write objects.
- **Counter Modules and Circuit Applications** – How to employ the counter modules built into each cog to perform measurements and control processes that require precise timing. (Each cog has two counter modules that can function in parallel with the cog's program thread.)

The last four labs (I/O and Timing through Counter Modules and Circuit Applications) have questions, exercises, and projects at the end of the chapter with answers in Appendix B: Study Solutions, starting on page 195. For best results, hand-enter the code examples as you go through the labs. It'll give your mind time to consider each line of code along with the concepts and techniques introduced in the various sections of each lab.

More PE Kit Labs & Applications Online

To find additional labs and applications that build on the concepts introduced in this book, go to forums.parallax.com → Propeller → Propeller Education Kit labs. You will find links to PDFs and discussions for each of the labs in this text along with additional material, like the ViewPort lab excerpt shown in Figure 1-11. Some of these labs will utilize the parts on the PE Kit, and others require additional parts, most of which are available from Parallax or other electronics suppliers.

Figure 1-11: ViewPort Lab Excerpt

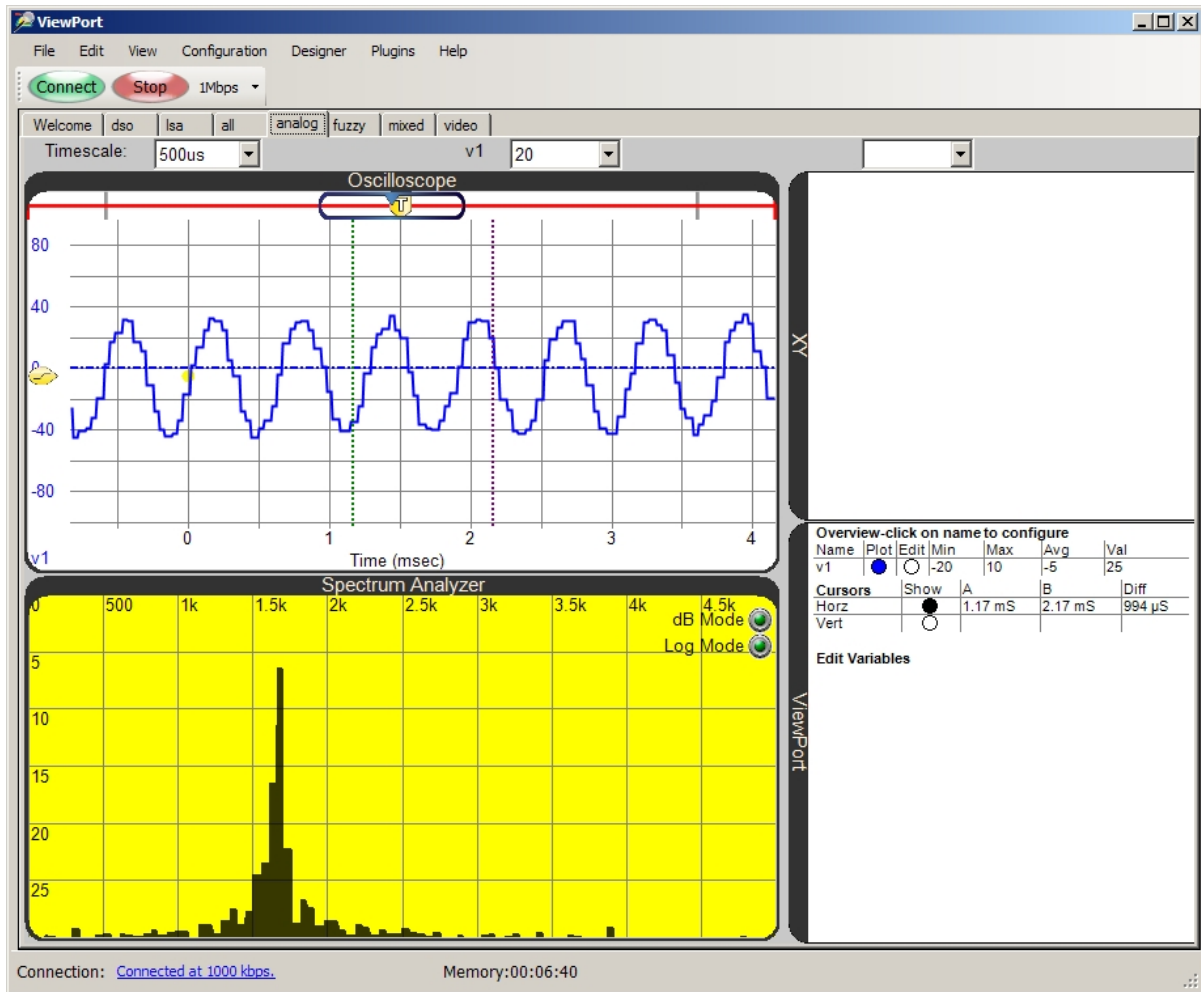

Oscilloscope and spectrum analyzer display signals generated by a microphone as someone whistles into it. The Propeller chip samples these signals and forwards them to the ViewPort PC Software. This is one of the activities featured in the ViewPort Lab.

2: Software, Documentation & Resources

The Parallax Propeller Tool software and Parallax Serial Terminal shown in Figure 2-1 are free downloads from www.parallax.com. You'll use the Propeller Tool to write programs for the Propeller chip, and the Parallax Serial Terminal will provide bidirectional text communication between the PC and Propeller chip. On the same page with the Propeller Tool software, you will also find several reference documents and the example programs for these labs. This chapter includes download and setup instructions for all these items along with pointers to other useful resources for developing projects, prototypes and products with the Propeller microcontroller.

Figure 2-1: Propeller Tool and Parallax Serial Terminal

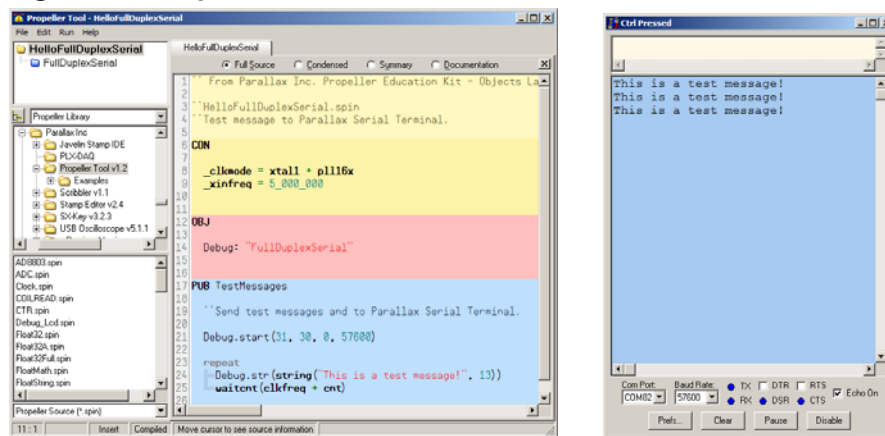

Download Software and Documentation

In these labs, you will make use of the Propeller Tool programming software, the Parallax Serial Terminal, and the Propeller Manual reference documentation. These items along with the Propeller microcontroller datasheet are all on a single page at www.parallax.com.

- ✓ Go to www.parallax.com/Propeller → Downloads & Articles.
- ✓ Download the following items and place them in a convenient folder.
 - Propeller Tool Software v1.2 or newer. System requirements: Windows 2K/XP/Vista and an available USB port.
 - Parallax Serial Terminal Software
 - Source Code – for the Propeller Education Kit Labs: Fundamentals (.zip)
 - Book – Propeller Education Kit Labs: Fundamentals (.pdf)
 - Propeller Manual
 - Propeller Datasheet
 - If you are using the PropStick USB version of the PE Kit, be sure to locate its separate Setup and Testing Lab PDF file.

One of the Propeller Tool default installation features is the USB drivers for the programming/communication/debugging tools included in your PE Kit. When you install the Propeller Tool software, it will automatically install the drivers your PC will need to communicate with the Propeller Plug's or PropStick USB's serial-over-USB circuits. These are FTDI's VCP USB drivers for Windows 2K/XP/Vista. You may also obtain drivers from www.ftdichip.com.

Software, Documentation & Resources

- ✓ Install the Propeller Tool software by running the setup program and following the prompts. When you get to the Install Optional Driver Step shown below, make sure to leave the *Automatically install/update driver* box checked.

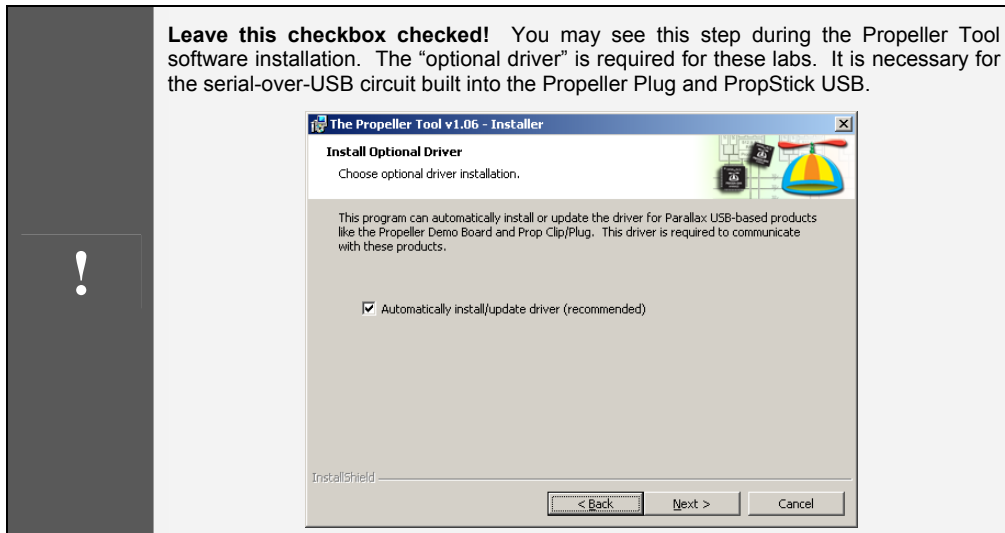

Install the Parallax Serial Terminal

The Parallax Serial Terminal is a stand-alone executable that can be used to exchange serial messages with the Propeller chip at runtime. In addition to enhancing some of the PE Kit Lab examples with text messages indicating status and values, it can also be useful for rudimentary datalogging and debugging. Even though it's a stand-alone application, it is convenient to make a single copy of it and place a link next to the one you will use to open the Propeller Tool software.

- ✓ Unzip the Parallax Serial Terminal into the folder where the Propeller Tool software was installed. The default file path for the Propeller Tool v1.2 is C:\Program Files\Parallax Inc\Propeller Tool v1.2.
- ✓ Create a shortcut to the Parallax Serial Terminal next to the Propeller Tool software shortcut.

Useful Web Sites

In addition to www.parallax.com/Propeller, there are a couple of other web sites where you can get answers to questions as well as objects to reduce your development time on Propeller projects.

- Object exchange: <http://obex.parallax.com>
- Propeller Chip forum: <http://forums.parallax.com> → Propeller

Tech Support Resources

Parallax Inc. offers several avenues for free technical support services:

- Email: support@parallax.com
- Fax: (916) 624-8003
- Telephone: Toll free in the U.S: (888) 99-STAMP; or (916) 624-8333. Please call between the hours of 7:00 am and 5:00 pm Pacific time, or leave us a message.
- Forums: <http://forums.parallax.com/forums/>. Here you will find an active forum dedicated to the Propeller chip, frequented by both Parallax customers and employees.

3: Setup and Testing Lab for 40-Pin DIP PE Platform

This is the Setup and Testing lab for the 40-pin DIP version of the PE Kit.

- ✓ If you have the 40-Pin DIP version of the PE Kit (#32305), continue here.
- ✓ If you have the PropStick USB version of the PE Kit (#32306), check for a separate printed Setup and Testing Lab - PropStick USB Version document included with your kit. It is also a free download from the 32306 product page at www.parallax.com.

The PE Platform

The Propeller Education (PE) Kit Platform shown in Figure 3-1 makes a great reusable prototyping tool for electronics and robotics projects. It's also a great starting point for learning the basics of programming the Propeller Microcontroller to be the embedded computer brain in your next invention. This lab introduces the 40-Pin DIP PE Platform and its components and features, and then guides you through assembling and testing your PE Platform.

Figure 3-1: PE Kit Platform (40-Pin DIP version)

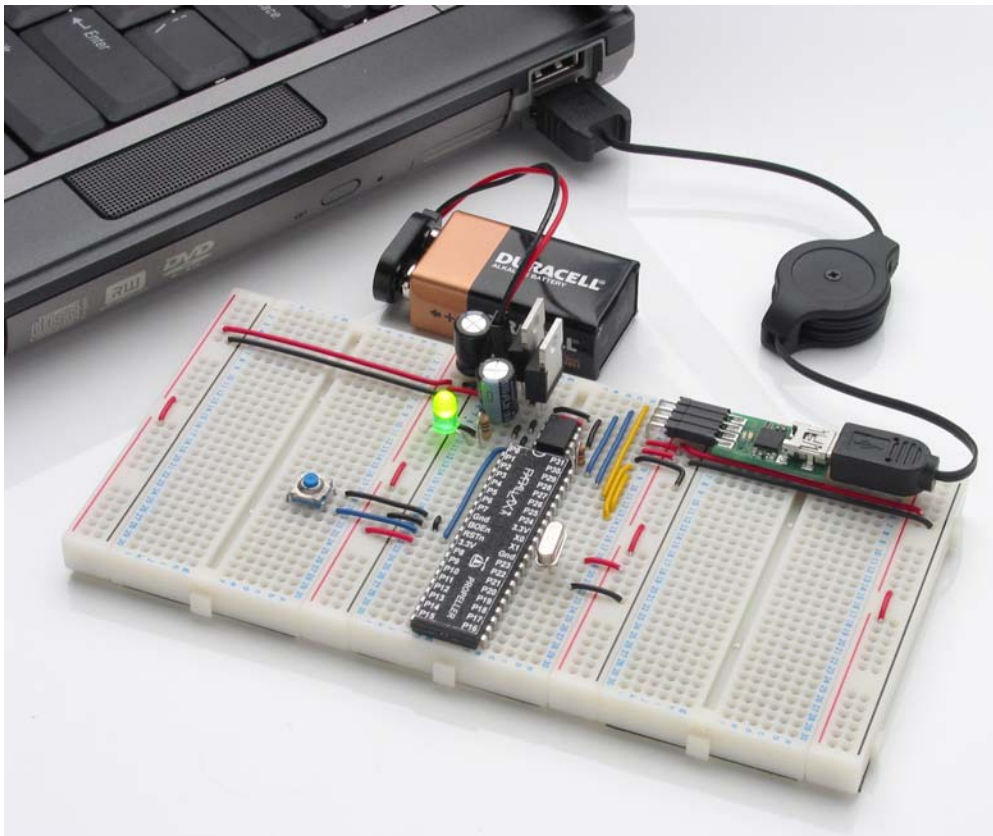

The PE Platform in Figure 3-1 is an array of breadboards connected side-by-side with the Propeller chip and support circuits and components mounted in the center. Each project circuit you build on the left or right breadboards will be adjacent to Propeller chip I/O pins for easy access. Each breadboard also has vertical power connectors on both sides so that ground and regulated 3.3 V are next to any given breadboard row. This arrangement makes most circuits very simple to wire and visually track. It also minimizes the wiring spaghetti and troubleshooting problems that can occur with tall individual breadboards.

PE Platform Components and Features

Figure 3-2 shows the 40-Pin DIP PE Platform's major components, including:

- Propeller microcontroller with pin map sticker affixed
- 9 V battery-to-breadboard connector
- 5.0 V and 3.3 V voltage regulators
- LED power indicator
- Reset button for manual program restarts
- 5.00 MHz external crystal oscillator for precise clock signal
- 32 KB EEPROM for non-volatile program storage
- Propeller Plug programming and communication tool for program downloads and bidirectional communication with the PC.

Figure 3-2: PE Kit Platform Components

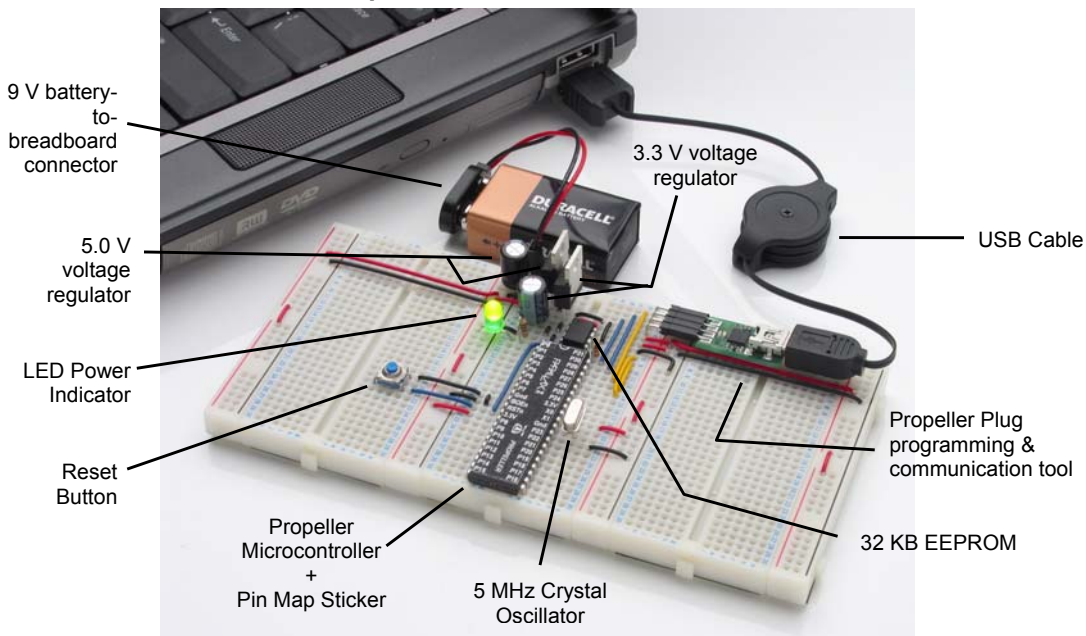

Propeller Microcontroller

A Propeller Microcontroller in a 40-pin DIP package provides a breadboard friendly brain for the PE Platform. This amazing microcontroller has eight processors, called cogs. Its system clock can run at up to 80 MHz, and each cog can execute up to 20 million instructions per second (MIPS). Each cog takes turns at accessing the Propeller chip's main memory. This memory access combined with the Spin (high level) and Assembly (low level) languages created especially for the Propeller makes writing code for multiple processors very simple and straightforward. If you've ever written a BASIC subroutine and subroutine call (or a C function and function call, or a Java method and method call), making a different processor execute that subroutine/function/method takes just two more steps. You'll see lots of examples of this as you go through the PE Kit Labs.



Propeller Datasheet and Propeller Manual

The Propeller Datasheet provides a complete technical description of the Propeller Microcontroller, and the Propeller Manual explains the chip's programming software and languages in detail. Both the Propeller Datasheet and Propeller Manual are available for PDF download from www.parallax.com. The printed version of the Propeller Manual is also available for purchase at the Parallax web site (#122-32000).

Reset Button

The reset button can be pressed and released to restart program execution. It can also be pressed and held to halt program execution. When released, the Propeller chip will load the program stored in PE Platform's EEPROM program and restart from the beginning.

9 V Battery-to-Breadboard Connector

This little gadget provides a simple, breadboard-friendly power supply connection. The recommended DC supply voltage across VIN–VSS is 6 to 9.5 VDC, and recommended power sources for VIN–VSS include:

- 9 V alkaline batteries
- Rechargeable 9 V batteries (common voltage ratings include 9 V, 8.4 V, and 7.2 V)



Always disconnect the battery from the connector and store separately. 9 V batteries should never be stored in the PE Kit plastic box because loose parts could short across the terminals. The 9 V battery should always be disconnected from the battery-to-breadboard connector and stored where its terminals cannot short across any metal objects or other conductive materials.

“Wall Warts”: The term “wall wart” commonly describes the DC supplies that draw power from AC wall outlets, and they often supply a much higher DC voltage than they are rated for. If you are going to use a wall wart, it's usually best to choose one that's rated for 6 V regulated DC output with a current capacity of 500 mA or more. The PE DIP Plus kit includes a 47 μF capacitor that can be placed across the battery inputs on the breadboard to provide the input capacitance required by the PE Platform's voltage regulator due to the wall wart's longer supply line.

5.0 V Regulator

The National Semiconductor LM2940CT-5.0 regulator is included in the PE Platform to make it convenient to supply 5 V components, such as the infrared detector introduced in the Counter Modules and Circuit Applications lab. A series resistor (typically 10 k Ω) should always be connected between a 5 V output and a Propeller I/O pin, which is 3.3 V. The 5 V regulator also serves as an intermediate stage between the battery input voltage and the 3.3 V regulator that supplies the Propeller chip.

The LM2940 voltage regulator circuit is designed to provide a 400 mA output current budget with a 9 V battery supply in the classroom or lab (at room temperature). This current budget can vary with supply voltage and temperature. For example, if the supply voltage reduced from 9 V to 7.5 V, the current budget increases to nearly 700 mA at room temperature. Another example, if the supply voltage is 9 V, but the ambient temperature is 100 °F (40 °C), the current budget drops to around 350 mA.



More Info:

- Appendix E: LM2940CT-5.0 Current Limit Calculations beginning on page 222 includes equations you can use to predict the PE Kit's 5 V regulator circuit's current budgets under various supply voltage and temperature conditions.
- The LM2940CT datasheet, available from www.national.com, has lots more information, including pointers for attaching a heatsink to the LM2940 to increase its current/temperature budget by improving its ability to dissipate heat

3.3 V Regulator

This National Semiconductor LM2937ET-3.3 regulator can draw up to 400 mA from the PE Platform's LM2940 (5 V regulator) at room temperature and supply the 3.3 V system with up to 360 mA of current. The 3.3 V system includes the Propeller chip, EEPROM, power LED, and the variety of 3.3 V circuits you will build in the PE Kit Labs.

Setup and Testing Lab

Keep in mind that if you have a power-hungry 5 V circuit, it subtracts current from the 5 V regulator's 400 mA output current budget, which in turn leaves the 3.3 V regulator with a smaller current budget to supply the rest of the system.

LED Power Indicator

This light turns on to indicate that power is connected to the board. It can also provide indications of dead batteries, short circuits, and even tell you if the Propeller Plug programming and communication tool is connected. As wired in this lab, it draws about 12 mA. After completing this lab, you can use a larger resistor for a less-bright indicator light that draws less current.

5.00 MHz Crystal Oscillator and Socket

The 5.00 MHz crystal oscillator provides the Propeller chip with a precise clock signal that can be used for time-sensitive applications such as serial communication, RC decay measurements and servo control. The Propeller chip has built-in phase locked loop circuitry that can use the 5.00 MHz oscillator signal to generate system clock frequencies of 5, 10, 40 or even 80 MHz.

The 5.00 MHz oscillator can also be replaced with a variety of other oscillators. A few examples include a programmable oscillator and a 60 MHz crystal. The Propeller chip also has a built-in RC oscillator that can be used in fast or slow modes (approximately 12 MHz and 20 kHz respectively). The internal oscillators are not nearly as precise as the 5.00 MHz oscillator, so if your project involves time-sensitive tasks such as serial communication, pulse width modulation for servo control, or TV signal generation, make sure to use the external 5.00 MHz oscillator.

32 KB EEPROM

The PE Platform's 32 KB EEPROM program and data storage memory is non-volatile, meaning it can't be erased by pressing and releasing the reset button or disconnecting and reconnecting power. This EEPROM memory should not be treated like RAM because each of its memory cells is only good for 1 million erase/write cycles. After that, the cell can actually wear out and no longer reliably store values. So, a program that modifies an EEPROM cell once every second would wear it out in only 11.6 days. On the other hand, if a cell gets modified every ten minutes, it'll be good for over 19 years.



EEPROM: Electrically Erasable Programmable Read-Only Memory

RAM: Random Access Memory.

Keep in mind that your application can use the Propeller chip's main memory (32 KB of which is RAM) for indefinite writes and rewrites at any frequency. It can then use the EEPROM to back up data that the application may need later, especially if that data has to live through disconnecting and reconnecting power. The EEPROM Datalogging Application (available at www.parallax.com → Propeller → Downloads & Articles) introduces an object that can be used to periodically back up values stored in RAM to EEPROM.

Propeller Plug Programming and Communication Tool

The Propeller Plug provides a serial-over-USB connection between the Propeller chip and PC for programming, communication, and debugging. This tool's blue LED indicates messages received from the PC, while the red one indicates messages transmitted to the PC. The FTDI chip labeled FT232 on the module converts USB signals from the PC to 3.3 V serial signals for the Propeller chip and vice versa.

On the PC side, a virtual COM port driver provided by FTDI is bundled with the Propeller Tool software you installed in the previous chapter. Aside from being necessary for the Propeller Tool software to load programs into the Propeller chip, the virtual COM port makes it convenient for the Propeller chip to communicate with serial software such as Parallax Serial Terminal.



More Virtual COM Port Info

After the FTDI virtual COM Port driver is installed by the Propeller Tool Installer, a Propeller Plug that gets connected to one of the PC's USB ports appears as a "USB Serial Port (COMXX)" in the Windows Device Manager's Ports (COM & LPT) list. The FTDI driver converts data placed in the COM port's serial transmit buffer to USB and sends it to the Propeller Plug's FT232 chip, and USB messages from the FT232 are converted to serial data and stored in the COM port's receive buffer. Serial communication software like the Propeller Tool and Parallax Serial Terminal use these COM port buffers to exchange information with peripheral serial devices.

Prerequisites

Please follow the directions in Software, Documentation & Resources, starting on page 17, before continuing here.

Procedure Overview

In this lab, you will assemble the PE Platform (40-Pin DIP version), following the steps listed below. It's important to follow the instructions for each step carefully, especially since you will be wiring up your own development platform (on the breadboard) instead of just plugging the Propeller microcontroller into a socket on a carrier PCB.

- Inventory Equipment and Parts
- Assemble the Breadboards
- Set up PE Platform Wiring and Voltage Regulators
- Test the PE Platform Wiring
- Socket the Propeller Chip and EEPROM
- Connect the Propeller Plug to the PC and PE Platform
- Connect Battery Power Supply
- Test Communication
- Load a Test Program and Test the I/O Pins
- Troubleshooting for the 40-Pin DIP PE Platform Setup (if necessary)

Since the PE Platform will be the microcontroller system at the heart of the PE Kit Labs, all its electrical connections should be tested before proceeding to the next lab. By following all the steps in this lab, it will help rule out potential wiring errors, which can easily slip by unnoticed as you build the PE Platform circuits, and then cause unexpected problems in later labs.

Setup and Testing Lab

Inventory Equipment and Parts

Required:

- Computer with Microsoft Windows 2000, XP, or Vista and an available USB port
- 9 V alkaline battery (For this Setup and Testing lab, use a new 9 V, alkaline battery.)
- PE Kit's Breadboard Set (#700-32305), Propeller Plug (#32201), and Propeller DIP Plus Kit (130-32305) listed in the tables below

Optional, but useful:

- Small needle-nose pliers and wire cutter/stripper
- Multimeter (DC + AC Voltmeter and Ohmmeter)
- Digital storage oscilloscope, such as the Parallax USB Oscilloscope (#28014)
- Antistatic mat and bracelet

!	<p>ESD Precautions: Electrostatic discharge (ESD) can damage the integrated circuits (ICs) in this kit. If you have an antistatic bracelet and mat, use them. If you don't, the metal chassis of a PC plugged into a grounded outlet can also provide a safe and convenient way of losing static charge periodically before and while handling ICs. The part of the chassis that's typically exposed on a PC is the frame on the back. The monitor and peripheral ports are connected to it with metal screws. Touch that frame (not the ports) before opening the antistatic bags and then frequently while handling the parts.</p> <p>Here are some more tips for reducing the likelihood of a static zap to PE Kit parts: Avoid touching the metal pins on the ICs. Handle ICs by their black plastic cases. Also, if you know your work area conditions cause you to build up static charge and then zap nearby objects, find another work area that is less static prone. Likewise, if you know a particular sweater causes you to build up charge in a certain chair, don't wear that sweater while working with the PE Platform.</p>
---	--

- ✓ Gather the components listed in Table 3-1, Table 3-2, and Table 3-3.
- ✓ Open up the PE Project Parts bag and check its contents against the PE Project Parts list in Table C-2 in Appendix C: PE Kit Components Listing.

Table 3-1: Breadboard Set (#700-32305)			
700-00077	3	Breadboard, 12x30 sockets, 3.19" x 1.65"	
700-00081	4	Breadboard, 2x24 sockets, 3.19" x 0.5"	









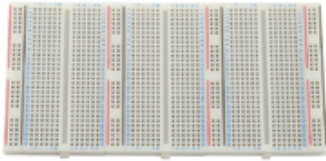









Table 3-2: Propeller Plug (#32201)			
32201	1	Propeller Plug	
805-0010	1	USB A to Mini B Retractable Cable	

Table 3-3: Propeller DIP Plus Kit (130-32305)		
Part Number	Quantity	Description
571-32305	1	9 V battery clip 
201-01085	2	Capacitor, Electrolytic, 6.3 V, 1000 µF 
201-04740	1	Capacitor, Electrolytic, 25 V, 0.47 µF 
150-01011	1	Resistor, CF, 5%, 1/4 watt, 100 Ω 
150-01030	1	Resistor, CF, 5%, 1/4 watt, 10 kΩ 
251-05000	1	Crystal 5.00 MHz, 20 pF, HC-49/µs 
350-00001	1	LED Green T1 ¼ 
400-00002	1	Pushbutton - normally open 
451-00302	1	2-pin m/m header 
451-00406	1	Extended right angle m/m 4 pin header with 0.1 spacing 
601-00513	1	3.3 V regulator, TO92 package 
601-00506	1	5.0 V regulator, TO92 package 
602-00032	1	32 kB EEPROM, DIP-8 
800-00016	6	Bags of 10 Jumper Wires 
P8X32A-D40 120-00003	1 1	Propeller Chip P8X32A - 40 pin DIP  Propeller DIP pin map sticker 

Parts and quantities subject to change without notice.

Assemble the Breadboards

The three 12-column × 30-row prototyping breadboards in Figure 3-3 have sockets whose locations can be described by (column letter, row number). Each column has a letter along the top and bottom of the breadboard and each row has a number along the sides. Two examples of breadboard coordinates in the figure are (K, 3) on the center breadboard, and (C, 7) on the right breadboard. Each breadboard is organized in rows of six sockets; all the sockets in each row of six are connected by a metal bracket underneath. So, to connect two or more wires together, just plug them into the same row of six sockets.

Setup and Testing Lab

- ✓ Connect the interlocking breadboards together as shown in Figure 3-3.

Figure 3-3: Breadboards

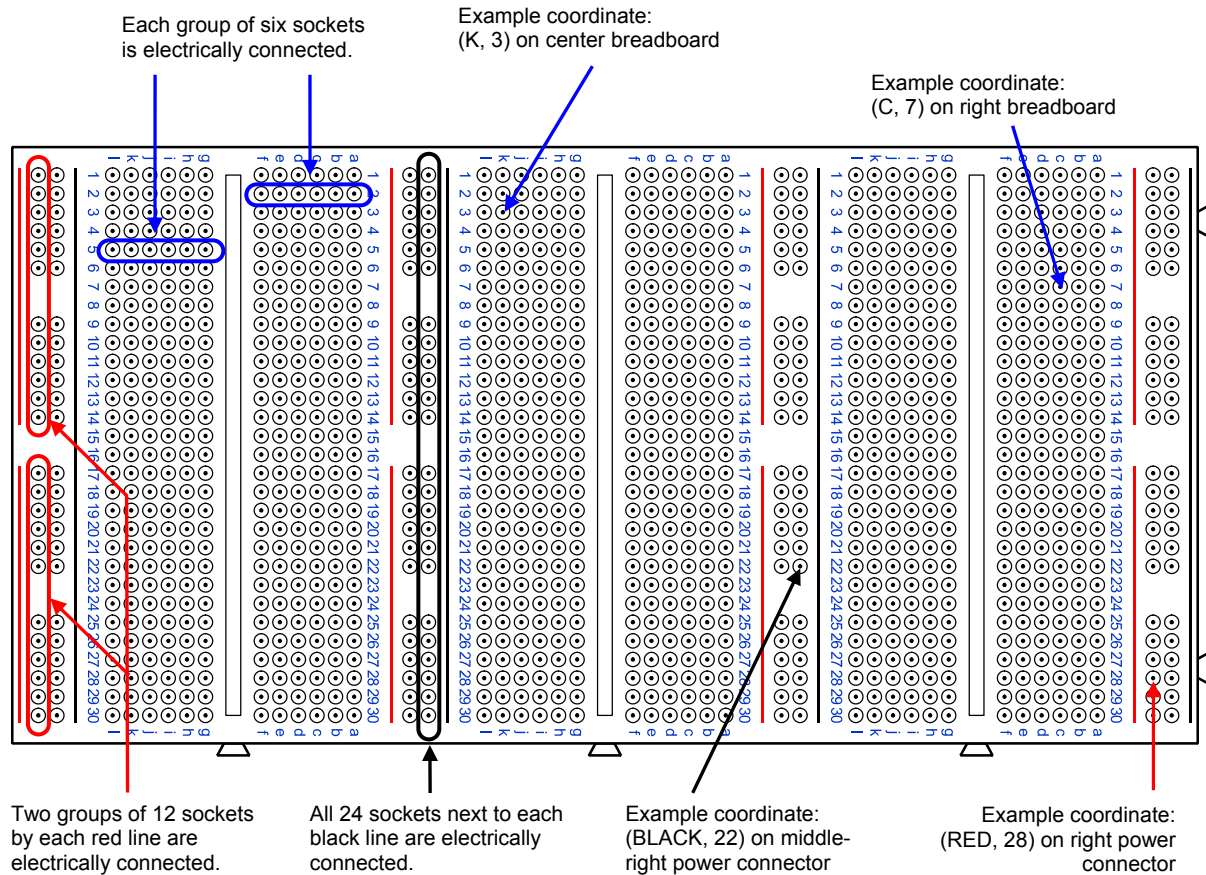

See it in color and zoom in: This file is available in color as a free PDF download from the Propeller Education Kit (32305) product page at www.parallax.com. You can also use Adobe Acrobat Reader to zoom in on regions of the various wiring diagrams, which can be useful for verifying where certain leads get plugged in.

Adhesive Backing - don't expose it. The breadboards have an adhesive backing covered with wax paper. Do not peel off the wax paper unless you are ready to permanently affix the breadboards to something permanent, such as a metal back plane cut to size or a project box.

VSS and GND; VDD and 3.3V: The Propeller chip's GND pin is referred to as VSS in the Propeller Manual, and VDD is +3.3 V.

Each breadboard in Figure 3-3 is flanked on both sides by a 2-column × 24-row power connector. The columns on these power connectors are indicated by black and red lines, and the rows are indicated by the breadboard row numbers. Example coordinates include (BLACK, 22) on the middle-right power connector and (RED, 28) on the right one.

On each power connector in Figure 3-3, all 24 sockets by the vertical black line are electrically connected. These sockets typically serve as a common ground, and each of these black columns gets connected to the battery's negative terminal on the PE Platform. Each power connector also has two groups of twelve sockets denoted by two vertical red lines. The upper twelve sockets next to the red line are grouped together, but are not connected to the lower twelve next to the other red line. The break in the red line by these socket groups indicates the break in continuity. The breadboard is

designed this way to accommodate two separate voltage supplies on the same power connector. This feature is not used now, so all the positive power connectors are shorted together with jumper wires, and then connected to the 3.3 V regulator's output to provide a supply for the PE Platform.

Set up PE Platform Wiring and Voltage Regulators

The PE Platform schematic shown in Figure 3-4 will be assembled in steps. In this section, you will first set up and test the wiring without the battery, Propeller Plug, Propeller chip or 24LC256 EEPROM. After some electrical tests to verify the wiring, you will connect and test each component. By following this procedure, you will minimize the likelihood of damaging one of the components due to a wiring error.

Figure 3-4: Schematic – Propeller DIP Plus Kit

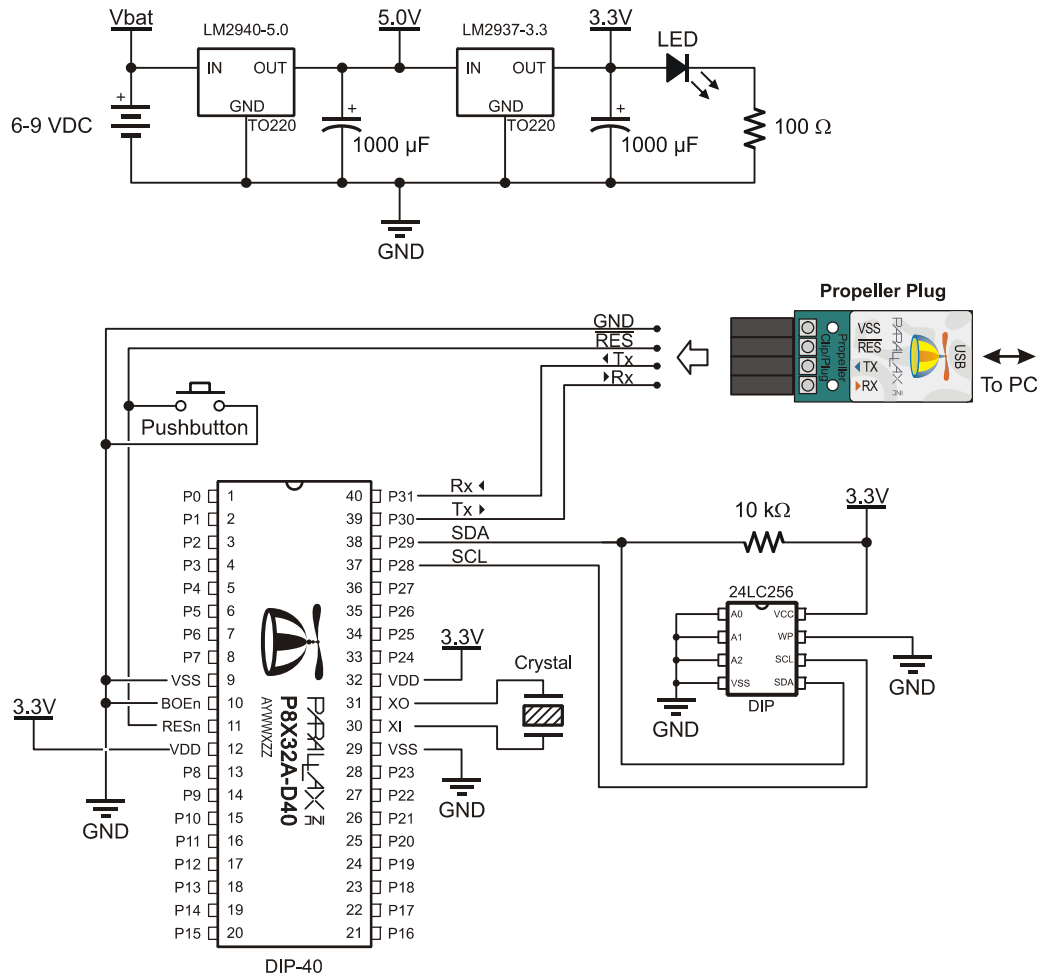

Figure 3-5 shows the wiring diagram we will use for the schematic in Figure 3-4. Note that the Propeller chip, 24LC256 EEPROM, Propeller plug and battery are not yet connected. Note also that the board in the wiring diagram is tight-wired, with all the wires cut to length to be flush with the breadboard surface. This will make it easier to identify and remove loose-wired project circuits without having to worry about potentially disconnecting a part or wire that's integral to the PE Platform.

- ✓ Make sure your breadboard is oriented so that the numbers and letters that indicate the breadboard socket coordinates are the same as in Figure 3-5.

Setup and Testing Lab

- ✓ Connect the wires and components exactly as shown in Figure 3-5. Make sure that all of the wires are securely plugged into their sockets. If you accidentally cut a wire too short and it has a tenuous connection in the socket, discard it and replace it with one you have cut to the correct length.
- ✓ The LED's anode should be connected to (RED, 10) and its cathode to (L, 10). The cathode pin is the one closer to the flat spot on the otherwise round rim at the base of the LED.
- ✓ The resistor across (K, 9) and (K, 10) is 100 Ω (brown-black-brown) and provides series resistance for the power LED.
- ✓ The resistor across (D, 5) and (D, 9) is 10 k Ω (brown-black-orange), and will pull up one of the EEPROM pins.

Figure 3-5: Wiring Diagram – Propeller DIP Plus Kit before ICs are Connected

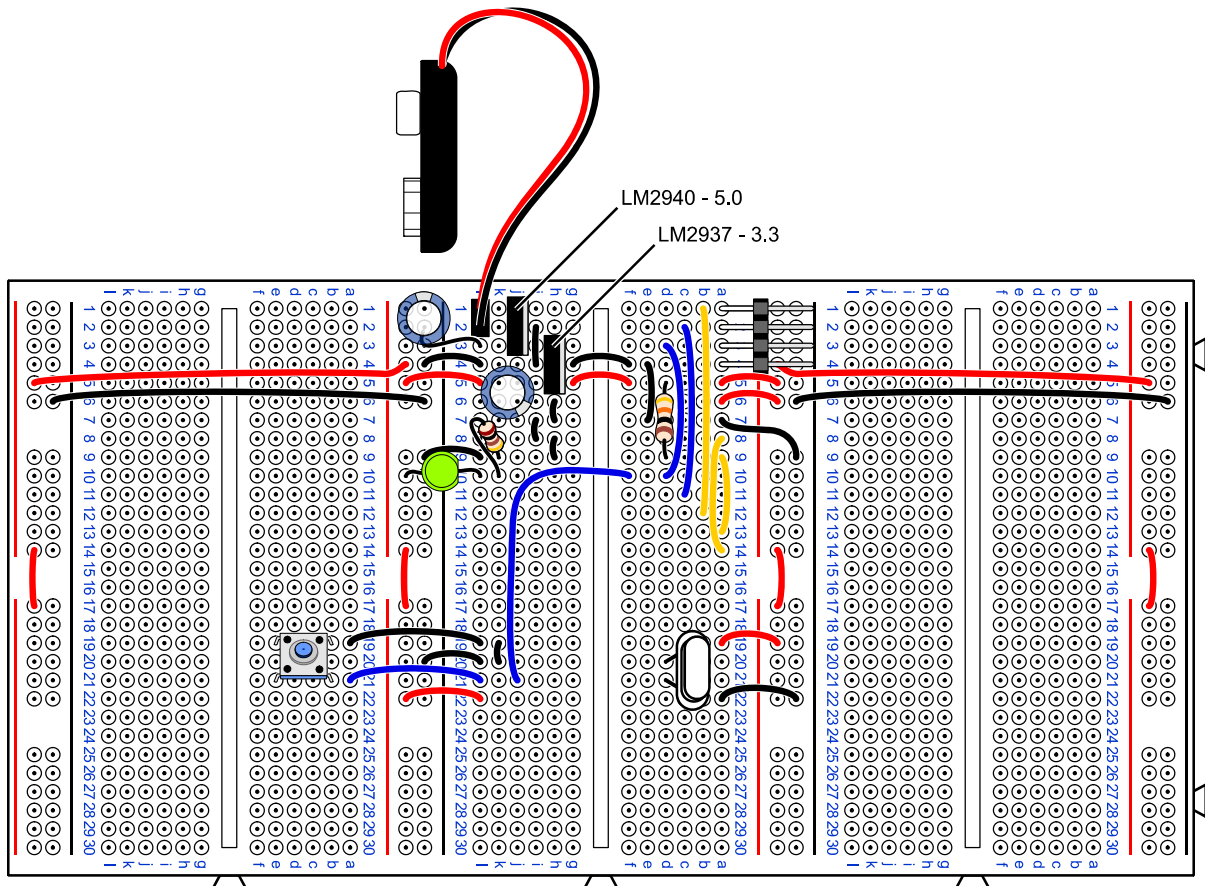

Verify Wiring Connections

It's important to eliminate any wiring mistakes before connecting power to the PE Platform. By double-checking your wiring and running a few simple tests, you can in many cases catch a mistake that might otherwise cause your system not to work or even damage some of its components. Although the PE Platform's parts are not expensive to replace, unless you have extras on hand, waiting while the new parts get shipped could turn out to be an unwelcome delay.

- ✓ Make a printout of Figure 3-5, and verify each connection by drawing over it with a highlighter pen after you have checked your wiring against the diagram, matching the coordinates of each socket that a part or wire is plugged into against the coordinates shown in the figure.

- ✓ The 9 V battery's red positive terminal wire should be plugged into the center breadboard's (L, 1) socket, and its black negative terminal plugs into (L, 2).
- ✓ The LM2940-5.0 voltage regulator in sockets (J, 1-3) should be plugged in so that the labeling on the black case faces left, and the heat conducting metal tab and backing faces right.
- ✓ The LM2937-3.3 voltage regulator in sockets (H, 3-5) should also be plugged in so that the labeling on the black case faces left, and the heat conducting metal tab and backing faces right.
- ✓ Verify that the LM2940 5 V regulator's output capacitor's negative terminal (find the stripe with the minus “-” signs on its metal case) is connected to (BLACK, 1) and that the LM2937 3 V regulator's output capacitor's negative terminal is plugged into either (J, 6) or (J, 7).



WARNING: Reverse voltage across an electrolytic capacitor can cause it to rupture or in some cases explode. The electrolytic capacitor's negative terminals (denoted by a stripe with negative signs) should always be connected to a lower voltage than its positive terminal.

- ✓ Verify that the Power LED's anode terminal is connected to (RED, 10) and that its cathode terminal (indicated by the shorter lead and flat spot on the otherwise cylindrical plastic case) is connected to (L, 10).

Test the PE Platform Wiring

This section has a list of test points that you can probe with a multimeter to verify that:

- The voltage regulators are correctly wired and working properly
 - The supply voltages are correctly distributed to all the power rails
 - The supply voltages are routed to the correct sockets to supply the Propeller and EEPROM chips.
- ✓ If you have a multimeter at your disposal, the test points are listed below.

Tests Points with Battery Disconnected

Continuity

Most multimeters have a continuity setting that allows you to probe for low resistances. The symbol for continuity test is typically a diode with a dot emitting sound waves, indicating that if the meter detects low resistance, it will play a tone. If your meter does not have a continuity test mode, consider measurements under 1 Ω as an indication of continuity.

Resistance measurements tend to vary with length of wire. For example, the resistance between (RED, 30) on the far left power connector and (RED, 30) on the far right power connector might measure in the 0.5 Ω range, while if you measure two points on the same power connector, it might measure almost nothing. The measurement will depend on your meter's calibration and probe resistance. You can find out what zero ohms should be by shorting your probes together.

If a pair of test points below fail the continuity test, look for missing jumper wires and loose connections on the center board and rails.

Setup and Testing Lab

- ✓ Battery clip's negative terminal sockets to the BLACK columns in all four power connectors. (The negative terminal on the battery clip is the smaller diameter terminal that's closer to the wires.)
- ✓ Battery clip's positive terminal to the center board's (G, 1)
- ✓ Battery clip's negative terminal to the following sockets: (G, 19), (G, 20), (F, 22), (D, 4), (F, 7), (G, 6, 7, 8, 9), (G, 2), and (K, 4).
- ✓ (I, 5) to (RED, 13) and (RED, 18) on all four power connectors.
- ✓ (RED, 18) to: (F, 19), (G, 22), (B, 5), and (B, 6).

Tests with Battery Connected

If your voltmeter is pretty accurate, measured voltages will typically fall in the ± 0.1 VDC range. Some inexpensive voltmeters out there have much lower accuracy. If you are using a very inexpensive voltmeter, or one with an unknown history, you may notice somewhat larger measurement variations.



The 0.47 μ F capacitor should be placed across the 9 V power input if you are using a 6-9 VDC supply that plugs into the wall, or any supply wire that's longer than 9 V battery-to-breadboard adapter that comes in the kit.

- ✓ Connect a new alkaline or freshly charged rechargeable 9 V battery to the PE Platform's battery clip. The power LED should glow brightly. If it does not, or if the green LED takes glows orange instead of green, disconnect the battery immediately and go to Troubleshooting entry (2) on page 39.

DC Voltage

- ✓ Test the voltage across the four red/black vertical power rails. The voltage across (RED, 13) and (BLACK, 13) should measure 3.3 VDC on each of the four power connectors. If the voltage is instead in the 4 V neighborhood or higher, disconnect power immediately and go to Troubleshooting entry (11) on page 42. If the voltage is otherwise incorrect, go to Troubleshooting entry (3) on page 40.
- ✓ Repeat the 3.3 VDC test for (RED, 18) and (BLACK, 13).
- ✓ (I, 1) on center breadboard to (BLACK, any): same as voltage across battery terminals.
- ✓ (G, 3) on center breadboard to (BLACK, any): 5 VDC. . If the voltage is instead in the 6 V neighborhood or higher, disconnect power immediately and see Troubleshooting entry (11) on page 42.

Socket the Propeller Chip and EEPROM

Figure 3-6 shows the PE Platform Schematic after the Propeller chip and EEPROM have been socketed.

- ✓ **Disconnect the battery from the clip for the next steps.**
- ✓ Identify the reference notch on the Propeller chip and pin map sticker, and compare their orientation to the reference notch on the pin map sticker in Figure 3-6. (The reference notch is the semicircle between the P0 and P31 labels on the pin map sticker, and it should correspond to an actual notch in the Propeller chip at the same location.)
- ✓ Affix the pin map sticker to the Propeller chip, making sure that the reference notch on the sticker is oriented the same way as the reference notch on the chip.
- ✓ Make sure that each pin is aligned with the correct breadboard socket it's going to get pressed into.

- ✓ Plug the Propeller chip into the breadboard, verifying its orientation against Figure 3-6. Press firmly with two thumbs.
- ✓ Find the reference notch on the 24LC256 EEPROM chip, then orient it as shown in Figure 3-6 and plug it in. The reference notch should be between the pins that are in the (F, 6) and (G, 6) sockets.

Figure 3-6: Wiring Diagram – Propeller DIP Plus Kit

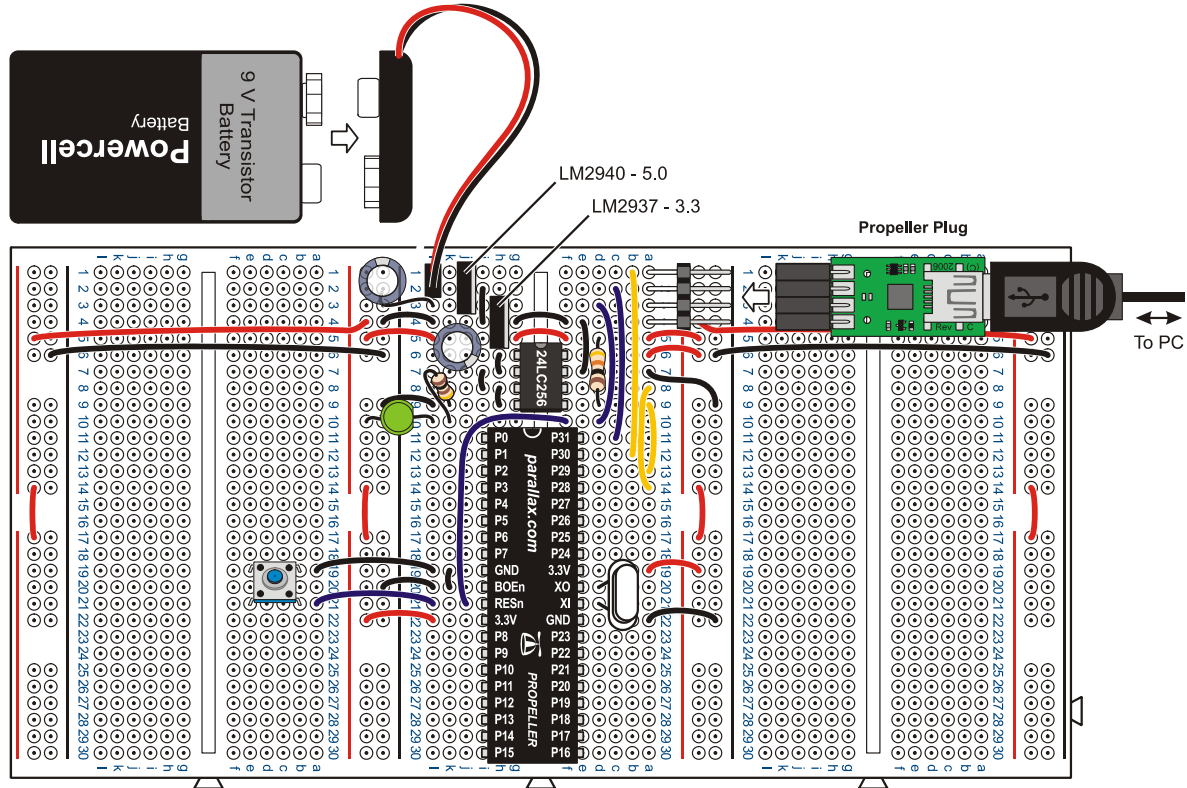

Connect the Propeller Plug to the PC and PE Platform

The Propeller Tool software should be loaded on your PC before starting here.

- ✓ If you have not already done so, complete the Software, Documentation & Resources lab, starting on page 17 before continuing here.

The first time you connect your Propeller Plug to your PC with a USB cable, two things should happen:

- 1) The Propeller Plug’s serial transmit and receive LEDs should flicker briefly.
- 2) The Windows operating system should display the message “Found New Hardware – USB Serial Port” followed by “Found New Hardware – Your new hardware is installed and ready to use.”

Each time you reconnect your Propeller Plug to the PC, the communication LEDs should flicker, but Windows typically does not display the serial port installation messages again after the first time.

- ✓ The battery should still be disconnected.

Setup and Testing Lab

- ✓ Connect the Propeller Plug to your computer with the USB cable, and verify that both of the Propeller Plug's communication LEDs (red and blue) flicker briefly immediately after you make the connection.
- ✓ Now, connect the Propeller Plug to the 4-pin header in your PE Platform *parts side up* as shown in Figure 3-6.
- ✓ Verify that the power indicator LED that's plugged into the (RED, 10) and (L, 10) sockets glows faintly. You may have to look straight down on its dome top to see the glow. ***If the power LED does not glow faintly, do not proceed to the next step.*** Instead, go to Troubleshooting entry (5) on page 40.

Connect Battery Power Supply

When you connect the battery supply, the power LED that glowed faintly when you connected the Propeller Plug should glow brightly. This indicates that the PE Platform's 3.3 V regulator is supplying 3.3 V power to the PE Platform's Propeller chip, EEPROM, and sockets next to the red stripes on the power connectors.

- ✓ Connect the battery to the battery clip as shown in Figure 3-6. The PE Platform's power LED should glow brightly. ***If it does not, unplug the battery immediately*** and go to Troubleshooting entry (4) on page 40. The same applies if the green power LED takes on an orange hue.
- ✓ If you have a voltmeter, test the voltage at the red and black power connectors. Each should now measure 3.3 VDC. If the voltage is incorrect, disconnect the battery and go to Troubleshooting entry (3) on page 40.
- ✓ Check the AC voltage across the red and black power connectors. There should only be about 50 mV of AC voltage. For AC voltages greater than 300 mV, go to Troubleshooting entry (11) on page 42.

Test Communication

The Propeller Tool software's Identify Hardware feature can be used to verify communication between the PC and the Propeller chip.

- ✓ Make sure that the battery is connected.
- ✓ Verify that the USB cable connects the PC to the Propeller Plug.
- ✓ Verify that the Propeller Plug is connected to the 4-pin header parts side up (label side down).
- ✓ Open the Propeller Tool software, click the *Run* menu select *Identify Hardware...* (or F7).
- ✓ If the Propeller Tool reports, "Propeller Chip version 1 found on COM...", continue to the next section (Load a Test Program and Test the I/O Pins). Otherwise, go to Troubleshooting entry (6) on page 41 and Troubleshooting entry (1) on page 37.

Load a Test Program and Test the I/O Pins

These tests are important before proceeding with the PE Kit labs. One example of a problem these tests can intercept is a bent I/O pin on the Propeller chip. Occasionally, one of the pins gets bent underneath the Propeller chip instead of sinking into its breadboard socket. It can be difficult to catch by visual inspection, but if an I/O pin does not sense inputs or control outputs, these tests will lead to finding the problem quickly. It might otherwise take a lot of time looking for an error in an application circuit or the accompanying code before discovering a bent pin is the culprit. So follow along and perform these tests. It won't take long, and it could end up saving you a lot of time later.

I/O Pin Test Circuit Parts

- ✓ Open up the PE Project Parts bag and check its contents against the PE Project Parts list in Table C-2 in Appendix C: PE Kit Components Listing.
- ✓ For the next test circuits, gather the following parts from the PE Project Parts bag:
 - (1) LED - Red, green or yellow
 - (1) Resistor – 100 Ω (brown-black-brown)
 - (1) Resistor – 10 k Ω (brown-black-orange)
 - (1) Pushbutton
 - (4) Jumper wires

Build the Test Circuit

The circuit shown in Figure 3-7 and Figure 3-8 will provide a means of testing the Propeller chip's I/O pins as both inputs and outputs. If any of the checklist instructions do not work, go to Troubleshooting entry (9) on page 41.

Start by verifying that the LED circuit is correct and that all the power connector sockets by the red vertical lines supply 3.3 V as follows:

- ✓ Disconnect the battery from the battery clip.
- ✓ Build the circuit shown in Figure 3-7 and Figure 3-8.
- ✓ Reconnect the battery to the battery clip.

The LED circuit can be tested by connecting it to one of the power connector rails' RED sockets, which should supply it with 3.3 VDC.

- ✓ Disconnect the LED wire from (L, 14) in Figure 3-8, and plug it into (RED, 13) on the power connector between the center and left prototyping breadboards. The LED should light. If it doesn't, double-check your wiring. First, make sure the LED is not plugged in backwards. Its shorter (cathode) leg should be plugged into a socket next to the black line on the left power connector.

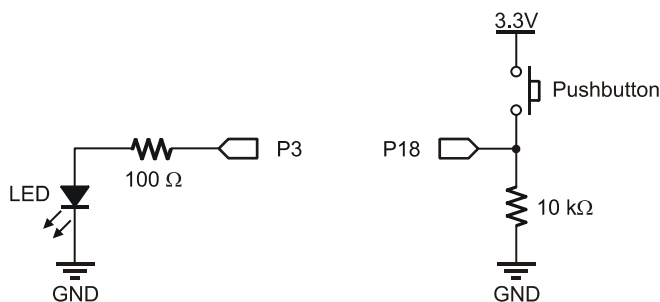
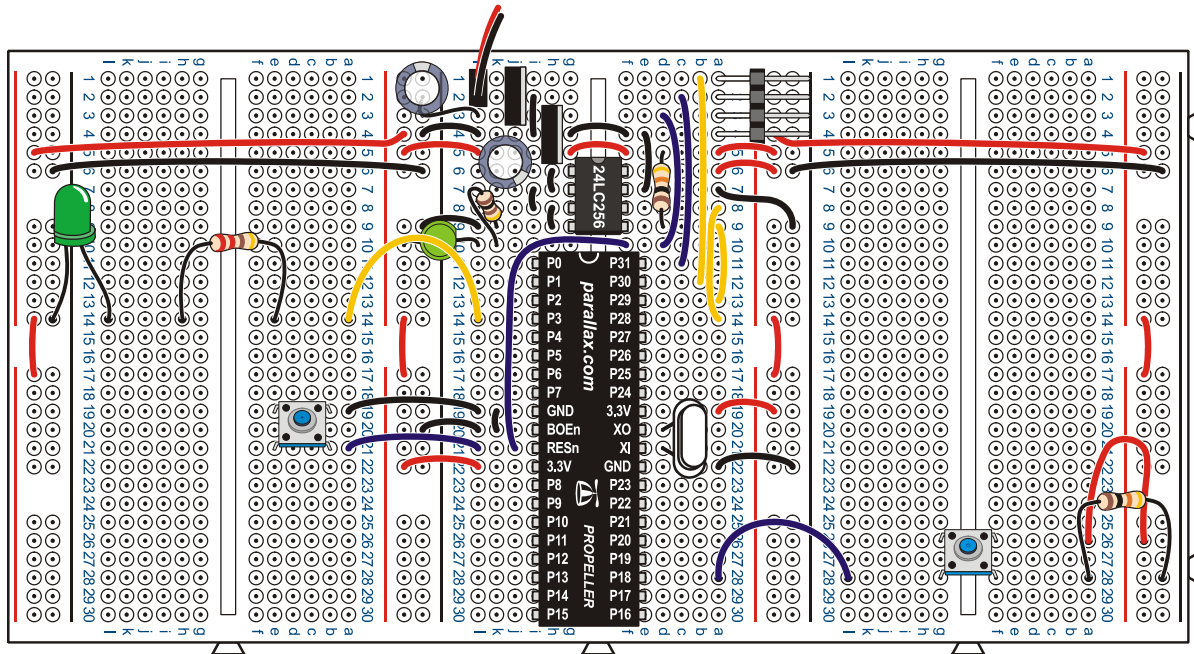

Figure 3-7: Test Circuit Schematic

Figure 3-8: Test Circuit Wiring Diagram



The LED circuit can also be used to test and make sure all the RED power rails are connected to the 3.3 V supply. If you already did that with a voltmeter, skip this checklist instruction.

- ✓ Unplug the wire from (RED, 13), and plug it into (RED, 12) on the leftmost power connector. The LED should glow again. Repeat for (RED, 18) on the leftmost power connector as well as (RED, 18) on the middle-left power connector. The LED should glow at each test point. If not, check your board against the wiring diagram in Figure 3-8 for missing jumper wires between RED power connector sockets.

After testing the LED circuit and power connectors, the LED should be reconnected to the Propeller I/O pin so that it can be used in conjunction with a test program to indicate that I/O pins are functioning properly as outputs.

- ✓ Reconnect the LED circuit to the Propeller chip’s P3 I/O pin (L, 14) in Figure 3-8.

Test Program – PushbuttonLedTest.spin

As written, PushbuttonLedTest.spin flashes an LED connected to any I/O pin on the Propeller chip’s left side (P0 to P15). The rate the LED flashes depends on whether or not the pushbutton connected to P18 is pressed (10 Hz) or not pressed (2 Hz). The wire connecting P3 to the LED circuit can be used to probe each I/O pin. For example, if that wire is instead connected to (L, 11), it confirms that P0 is functioning as an output if it makes the LED blink. Connect the wire to (L, 12), and it confirms, P1 is functioning, and so on, up through P15 (L, 30). You can use the pin map sticker on your Propeller chip to quickly and easily locate I/O pins.

I/O pin is an abbreviation for input/output pin.

The direction and state of each I/O pin is controlled by the program. Programs can set and modify the directions and states of individual I/O pins as well as groups of I/O pins at any time.

```

File: PushbuttonLedTest.spin
Test program for the Propeller Education Lab "PE Platform Setup"

CON

_clkmode      = xtall + pll16x      ' Feedback and PLL multiplier
_xinfreq      = 5_000_000          ' External oscillator = 5 MHz

LEDs_START    = 0                  ' Start of I/O pin group for on/off signals
LEDs_END      = 15                  ' End of I/O pin group for on/off signals
PUSHBUTTON    = 18                  ' Pushbutton Input Pin

PUB ButtonBlinkSpeed                ' Main method

  ' Sends on/off (3.3 V / 0 V) signals at approximately 2 Hz.

  dira[LEDs_START..LEDs_END]~~~    ' Set entire pin group to output

  repeat                             ' Endless loop
    ! outa[LEDs_START..LEDs_END]    ' Change the state of pin group
    if ina[PUSHBUTTON] == 1          ' If pushbutton pressed
      waitcnt(clkfreq / 4 + cnt)     ' Wait 1/4 second -> 2 Hz
    else                               ' If pushbutton not pressed
      waitcnt(clkfreq / 20 + cnt)    ' Wait 1/20 second -> 10 Hz

```

If the LED blinks at 2 Hz while the pushbutton is pressed and held, and blinks at 10 Hz after it is released, it confirms that P18 is functioning as an input. The program can then be modified and the wire connecting P18 to the pushbutton can be moved to each I/O pin on the right side of the Propeller chip to test those I/O pins as inputs.

After all the outputs on the Propeller chip's left side and all the inputs on its right side have been tested, the pushbutton can then be moved to the left side and the LED to the right. Then, the test can be repeated to verify that all I/O pins on the left function as inputs and the pins on the right function as outputs.

Load PushButtonLedTest.spin into EEPROM

You can load this program into the PE Platform's EEPROM memory by clicking the *Run* menu, selecting *Compile Current*, and then *Load EEPROM* (F11). After the program is loaded into EEPROM, the Propeller chip copies it from EEPROM into its main memory RAM and one of the Propeller chip's processors starts executing it. (If you disconnect and reconnect power or press and release the PE Platform's reset button, the Propeller chip will reload the program from EEPROM into main memory and start running it from the beginning.)

- ✓ Open PushbuttonLedTest.spin into the Propeller Tool, or type it in. If you type it, be careful to indent each line exactly as shown.
- ✓ Click the Propeller Tool's *Run* menu and select *Compile Current* → *Load EEPROM* (F11).

The Propeller Communication window will appear briefly and display progress as the program loads. If it closes after the "Verifying EEPROM" message, then the download was successful.

Setup and Testing Lab

- ✓ If instead an error window opens that reads “EEPROM programming error...” refer to Troubleshooting entry (8) on page 41.
- ✓ Verify that the LED connected to P3 flashes on/off rapidly, at 10 Hz.
- ✓ Press and hold the pushbutton down, and verify that the LED flashes slower, at only 2 Hz.
- ✓ If everything worked as anticipated, go on to I/O Pin Tests below. If it did not work, go to Troubleshooting entry (9) on page 41.

I/O Pin Tests

Use the pin map sticker on the Propeller chip to locate Propeller I/O pins. If any of these tests indicate that an I/O pin is faulty, refer to Troubleshooting entry (10) on page 42. The first step is to use the LED circuit to verify that each I/O pin on the left side of the Propeller chip functions as an output.

- ✓ Unplug the end of the wire that’s in (L, 14) and use it probe P0 through P15. (L, 11) through (L, 18) and (L, 23) through (L, 30). Each I/O pin should cause the LED circuit to blink.

Next, use the Pushbutton circuit to verify that each I/O pin on the right side of the Propeller chip functions as an input.

- ✓ Press and hold the pushbutton on the right breadboard. The LED circuit on the left breadboard should flash at 2 Hz instead of 10 Hz.
- ✓ Disconnect the battery from the battery clip.
- ✓ Unplug the pushbutton wire at P18, (A, 28) on the center breadboard, and plug it into P16 (A, 30).
- ✓ Modify the program to monitor P16 instead of P18 by changing the PUSHBUTTON CON directive in the PushButtonLedTest.spin object from 18 to 16.
- ✓ Reconnect the battery to the battery clip.
- ✓ Load the modified program into RAM by clicking the Run menu and selecting Compile Current → Load RAM (F10).
- ✓ Verify that the pushbutton, which is now connected to P16, controls the LED frequency.
- ✓ Repeat this procedure for P17, P19, P20, and so on, up through P27.



Load RAM (F10) vs. Load EEPROM (F11): The Propeller Tool software’s Load RAM feature is fast, but the program gets erased whenever power gets disconnected/reconnected or the PE Platform’s reset button gets pressed. After a reset, the Propeller chip will load the program most recently loaded into EEPROM and start executing it. While programs loaded into EEPROM do not get erased, they take longer to load. Since testing the pushbutton involves iteratively changing and reloading the program into the Propeller chip, it saves time to use Load RAM.

What about testing P28..P31? These propeller I/O pins are hardwired to the FTDI USB → serial chip and EEPROM program memory. If you were able to use the Load EEPROM feature it confirms that these I/O pins are fully functional. While it’s true that these pins can be used with some application circuits, you would need to make sure that the application circuits will not damage and cannot be damaged by the other circuits connected to P28..P31. See Figure 3-4 on page 27 for details. For the most part, the PE Kit labs will not use these I/O pins for application circuits.

At this point, half of the Propeller chip’s I/O pins have been tested as outputs, and the other half have been tested as inputs. Before moving the test circuits to opposite sides of the board, it’s a good idea to load an empty program into the PE Platform’s EEPROM so that the Propeller chip won’t send signals to the wrong I/O pins. The power should be disconnected when the circuit is changed. To make sure the empty program runs automatically when the power gets reconnected, it should be loaded into EEPROM using F11.

- ✓ Load this program (DoNothing.spin) into EEPROM (F11):

```
'' File: DoNothing.spin
PUB main                               ' Empty main method
```

Now, power can be disconnected, the pushbutton can be moved to the left breadboard, and the LED circuit can be moved to the right breadboard.

- ✓ Disconnect the battery and USB cable.
- ✓ Move the LED circuit to the right breadboard and connect it to P16.
- ✓ Move the pushbutton to the left breadboard and connect it to P15.
- ✓ Modify the object PushbuttonLedTest.spin as follows:
 - Change the LEDs_START **CON** directive from 0 to 16.
 - Change the LEDs_END **CON** directive from 15 to 27.
 - Change the PUSHBUTTON **CON** directive to 15.
- ✓ Reconnect the USB cable and battery.
- ✓ Load the modified PushbuttonLedTest.spin object into EEPROM using F11.
- ✓ Repeat the output LED tests for P16 to P27.
- ✓ Repeat the input pushbutton tests starting at P15, then P14, and so on through P0. Remember to modify the code, and then load RAM using F10 between each test.

Before Changing or Adjusting Circuits

The program DoNothing.spin causes all the I/O pins to be set to input, ensuring that it cannot inadvertently send a high (3.3 V) signal to a circuit that's sending a low (0 V) signal, or vice versa.

When you are finished testing, it's a good idea to load the DoNothing.spin object back into EEPROM so that your Propeller chip cannot damage the next circuit that gets connected to it. In fact, make it a habit. **Always load DoNothing.spin into EEPROM using F11 before disconnecting power and building a new circuit or making changes to an existing one.**

- ✓ Load DoNothing.spin into EEPROM (F11) now.

When you reconnect power, DoNothing.spin will automatically load from EEPROM to Propeller main memory, and the Propeller chip will execute it. It will set all I/O pins to input by default. Then, the program ends, and the Propeller chip goes into low power mode. This protects the Propeller chip and your new circuit from the time you turn power back on until the time you load the program for your new circuit into the Propeller chip.

Troubleshooting for the 40-Pin DIP PE Platform Setup

(1) Programming Connection and Serial Port

- a. When you connect the Propeller plug to the USB port, the red and blue LEDs next to the Propeller Plug's mini B connector should flicker briefly. If not, try a different port. If none of the ports result in this response, contact Parallax technical support. (See Tech Support Resources on page 18.)
- b. Run the Propeller Tool, click the *Run* menu and select *Identify Hardware* (F7). If you get the message shown in Figure 3-9:
 - i. Make sure the USB cable is connected to both the Propeller Plug and your computer's USB port.
 - ii. Check the following jumper wires on your PE Platform: (D, 3) to (D, 10), (F, 10) to (F, 21), (B, 1) to (B, 12), and (C, 2) to (C, 11)

- iii. Also, make sure the battery is connected and that the PE Platform's green power LED is glowing brightly. Then, try F7 again.
- iv. If that does not correct the problem, try connecting the cable to a different USB port on your computer.

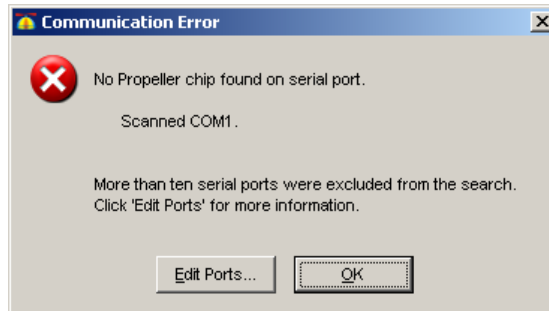

Figure 3-9:
Communication Error Message

- c. If you still get the Figure 3-9 message after ensuring that the USB cable is connected:
 - i. Click the Communication Error message box's *Edit Ports* button. The Serial Port Search List window in should appear. You can also access this utility by clicking the *Edit* menu and selecting *Preferences (F5)*. Click the *Operation* tab and then click the *Edit Ports* button.
 - ii. Leave the USB cable plugged into the Propeller Plug and unplug and re-plug the USB cable into the PC's USB port. Wait about 20 seconds between disconnecting and reconnecting the USB cable. The list should update and show a new "USB Serial Port" entry like the COM46 line in Figure 3-10.
 - iii. If it appears in light gray print, right-click the entry and select *Include Port (COMX)*, or in some cases *Re-Include Port*.

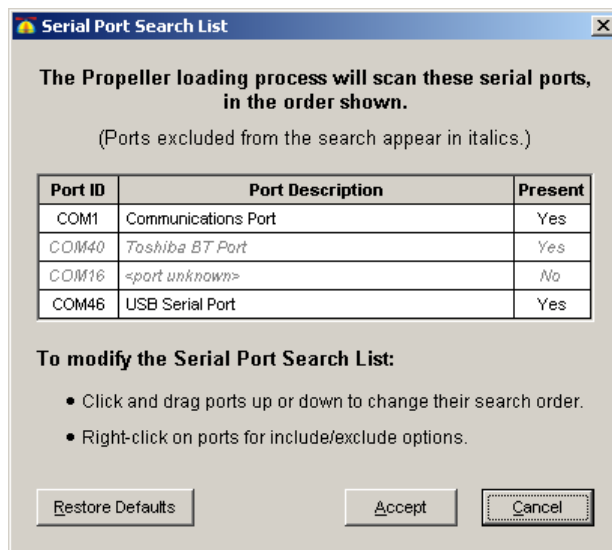

Figure 3-10: Serial Port Search List

- d. If the serial port search list already does scan for and recognize that port, go to www.parallax.com and click on the USB Driver Installer link at the bottom of the page, and then follow the Troubleshooting link at the bottom of that web page.
- e. If the Propeller Tool software still displays the "No Propeller chip found..." message, use your Device Manager to locate the USB Serial Port.
 - i. To access the Ports List in the Windows Device Manager, right-click *My Computer* and select *Properties*. Click the *Hardware* tab, and then click the

Device Manager Button. In the *Device Manager*, click the + next to Ports (COM & LPT).

- ii. Each time you plug in the USB cable, a reference to USB Serial Port (COMXX) should appear, as shown in Figure 3-11. Each time you unplug the cable that connects the Propeller Plug to the PC, the reference should disappear. For example, the Device Manager below shows USB Serial Port (COM 46), which indicates that a Propeller Plug might be connected to COM46.

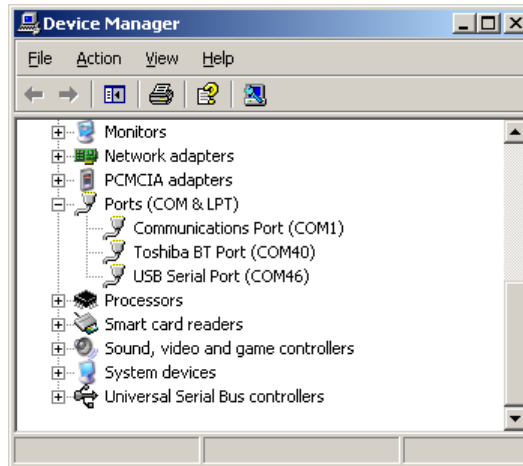

Figure 3-11: Device Manager Ports List

- iii. If the USB Serial Port entry does not appear in the Ports (COM & LPT) list but the Device Manager display appears to refresh every time you plug and unplug the USB cable:
 1. It may indicate that the Propeller Plug was plugged into the PC and an attempt to manually install the driver was made before the Propeller Tool software and driver were installed. Browse the list to find the driver that gets added each time you plug in the Propeller Plug. When you find it, uninstall it. You can typically do this by right-clicking the driver and selecting *Uninstall*.
 2. Then, unplug the Propeller Plug. Before plugging it back in, make sure the FTDI USB Driver is installed. The easiest way to do this is to uninstall and reinstall the Propeller Tool.
 3. When you reinstall the Propeller Tool software:
 - a. Make sure the checkbox for installing the USB drivers is checked! See the Download Software and Documentation section on page 17 for more information.
 - b. After you have reinstalled the software, the correct driver should automatically get installed when you connect the Propeller Plug to the PC. Make sure to leave the battery disconnected when you connect the Propeller Plug to the PC with the USB cable for the first time.
- f. Contact Parallax Tech Support. (See page 18.)

(2) If the PE Platform's power LED did not light, or if it glowed orange, when the battery was connected:

- a. If the power LED glowed orange:
 - i. Check for a short between the LED's cathode and ground. The LED should have a 100 Ω series resistor between its cathode (L, 10) and ground (BLACK, 9). The resistor should bridge (K, 9) to (K, 10).

- ii. Check to make sure the voltage at the LED's anode (RED, 10) is 3.3 V.
- b. If the LED did not light, it may be plugged in backwards. Check to make sure the cathode is connected to the resistor and the anode is connected to the 3.3 V supply. In terms of Figure 3-5 on page 28, the pin coming out by the flat spot on the otherwise cylindrical base of the LED's round plastic housing should be plugged into (L, 10). The other (anode lead) should be connected to (RED, 10). See Verify Wiring Connections on page 28 for details.
- c. Make sure the battery's (+) terminal is connected to (L, 1) and its (-) terminal is connected to (L, 2).
- d. There could be a wiring mistake causing a short circuit from one of the supply voltages to ground. If you don't have a multimeter, start visually checking your wiring again. With a multimeter, you can check the resistance between the battery's negative terminal, and the three positive supplies. Make sure to disconnect the USB cable and battery before testing resistance.
 - iii. Start by measuring the resistance between the 3.3 V connection and the battery's negative terminal. For example, test at probe points: (RED, 13) and (J, 4) in the center breadboard.
 - iv. Repeat resistance measurements between the battery's negative terminal (J, 4) and the 5 V regulated output (G, 3) as well as (J, 4) and the battery input (G, 1). If any of these resistance measurements shows less than 10 Ω , that supply voltage may have been shorted to ground.
 - v. Contact Parallax Tech Support. (See page 18.)

(3) If the voltage across the power connectors (RED–BLACK) is not 3.3 V:

- a. If your meter is a lesser-quality model or has been subject to heavy use by other students, check it against a known voltage before trusting its measurements.
- b. Repeat Verify Wiring Connections section starting on page 28. Carefully continue through Connect Battery Power Supply on page 32, paying close attention to detail, and hopefully you'll catch the error this time around. These tests can rule out a variety of problems, including shorts with the 5 and/or 9 V supplies.

(4) If the Power LED does not light when you plug the battery in after socketing the Propeller chip, but it checked out during previous testing:

- a. Check for wiring errors to its pins: If a wire terminates at a row that is shared with a Propeller chip or 24LC256 EEPROM pin, it's a prime suspect. Make sure the socket coordinates are identical to Figure 3-5 on page 28, and Figure 3-6 on page 31.
- b. Remove the Propeller chip and 24LC256 EEPROM from the breadboard and repeat Verify Wiring Connections on page 28. Continue through Connect Battery Power Supply on page 32 with attention to detail, and hopefully you'll catch the error this time around.
- c. Contact Parallax Tech Support. (See page 18.)

(5) If the Power LED does not glow faintly after you connect the Propeller Plug to the PE Platforms 4-pin header and to the PC with a USB cable:

- d. Verify that the resistor in the LED circuit is 100 Ω (brown, black, brown).
- e. Verify that the power LED's anode is plugged into (RED, 10), and the cathode is plugged into (L, 10). The cathode is the pin by the flat spot at the base of the otherwise cylindrical plastic case.
- f. Try the other USB Ports on your PC.
- g. Try one of the green LEDs from the PE Project Parts kit. The long (anode) pin should plug into (RED, 10), and the shorter (cathode) pin into (L, 10).
- h. Check all wiring details against Figure 3-5 on page 28, and Figure 3-6 on page 31.

- i. Remove the Propeller chip and EEPROM from the breadboard and repeat Test the PE Platform Wiring on page 29. Continue through Connect Battery Power Supply on page 32, and hopefully you'll catch the error this time around.
 - j. Contact Parallax Tech Support. (See page 18.)
- (6) Common causes of the “No Propeller Chip found...” message are:**
- a. Battery disconnected. Connect the battery.
 - b. Dead battery, battery that needs to get recharged.
 - c. USB cable not connecting Propeller Plug to PC. Make sure both ends are plugged in.
 - d. Propeller Plug not plugged into the 4-pin header, or plugged in upside-down. It should be parts side up (label side down).
 - e. Damaged or worn USB port. Most computers have more than one USB port. Try another port.
 - f. Propeller chip or 24LC256 EEPROM not fully plugged in. The underside of the Propeller chip and 24LC256 EEPROM should both be flush with the top of the breadboard. If not, make sure all the pins are lined up with the breadboard holes, then press down firmly on each chip.
 - g. FTDI USB drivers not installed. See entry (1) in this section.
 - h. Supply voltages – if you didn't check the voltages with a voltmeter, it's time to get one and do that. (See Test the PE Platform Wiring on page 29.) If the supply voltages are incorrect, see entry (3).
 - i. Propeller chip plugged in upside down. The semicircle Pin-1 indicator on the Propeller chip sticker shown in Figure 3-6 on page 31 should be adjacent to row 11, not row 30. Also, verify that the semicircle notch in the Propeller chip is under the printed semicircle on the sticker, also adjacent to row 11.
 - j. Defective USB Cable. If you have a spare USB A to mini B cable, try it.
- (7) If the test LED circuit does not light when you plug the jumper wire into (RED, 13):**
- a. The polarity on the LED may be backward. Check to make sure the LED's cathode is connected to a socket on the power connector next to the black line.
 - b. If the LED did not light when probing the power connector on the left, check to make sure the jumper that that connects the red column in the middle-left power connector to the red column on the far left power connector.
- (8) If you get an “EEPROM programming error...” message when you use the Propeller Tool's Load EEPROM feature:**
- a. Check for loose USB and battery connections.
 - b. If the problem persists, try a different USB port.
 - c. If you have a spare USB A to mini B cable, try it.
 - d. The Propeller chip may not be firmly socketed. See Socket the Propeller Chip and EEPROM on page 30.
 - e. Check the following connections: (A, 8) to (A, 14), (A, 9) to (A, 13), (BLACK, 9) to (L, 9), (H, 6) to (H, 7), (I, 7) to (I, 8), (H, 8) to (H, 9), (E, 4) to (E, 7), (RED, 6) to (A, 6), and the 10 k Ω resistor across (D, 5) and (D, 9). See Figure 3-6 on page 31.
 - f. Make sure the 24LC256 is not socketed upside-down. The reference notch on the top-center of the chip should be between (F, 6) and (G, 6).
 - g. If the problem still persists, contact Parallax Tech Support. (See page 18.)
- (9) If the program downloads, but the test LED circuit does not flash:**
- a. If you hand-entered the program, download it from the Propeller Education Kit page instead. Open it with the Propeller Tool software, and use F11 to download it to EEPROM. This will eliminate the possibility of a typing error during program entry.

- b. If the LED does not start flashing, check to make sure the oscillator is plugged in to the socket. (See the 5.00 MHz Crystal in Figure 3-2 on page 20 and check Figure 3-5 on page 28 for the correct sockets for connecting the 5.00 MHz oscillator.)
- c. Remove the oscillator and plug it back in, then re-test.
- d. Try changing the line in the PushButtonLedTestv1.0.spin that reads `_clkmode = xtal1 + p1116x` to `_clkmode = xtal1 + p118x`. If this change causes the light to start flashing, change it back to `p1116x`, load this original program back into the Propeller chip and verify that the light won't flash. If that's the case, please contact Parallax Tech Support. (See page 18.)

(10) Propeller chip I/O pins are factory tested before shipment. If the LED or pushbutton tests indicate a bad I/O pin:

- a. Take a close look at the pin and verify that it did not miss the socket and bend under the chip's case.
- b. Try touching the LED probe lead to the I/O pin. If the light blinks with this electrical contact, but not when it is plugged into an adjacent socket:
 - i. Again, take a look to make sure the pin is not bent under the module.
 - ii. Try unsocketing the Propeller chip, and verify that the pin is not bent.
 - iii. If you have a multimeter, test continuity between the socket the I/O pin was in and the socket the wire was plugged into. If there is no continuity, please contact Parallax Tech Support. (See page 18.)
- c. If the continuity in the breadboard row is good, and the pin is not bent, plug the Propeller chip back into the breadboard, and test all I/O pins, and take notes on which ones work and which ones don't. Also, make notes of any events you observed during testing, and then contact Parallax Tech Support. (See Tech Support Resources on page 18.)
- d. Please see the Warranty Policy at www.parallax.com for more information on replacing a module with damaged I/O pins.

(11) 4 VDC or more across (RED, any) and (BLACK, any), or 6 VDC or more across (G, 3) to (BLACK, any).

- a. a. One of the 1000 μ F capacitors may not be properly connected. This is indicated by a DC voltage measurement that is 1 to 2.5 V above what it should be.
 - i. Check to make sure the capacitor leads are inserted into the correct sockets.
 - ii. Check to make sure the capacitor leads are long enough and making sufficient contact with the socket.
- b. If the voltage across (G, 3) to (BLACK, any) turns out to be 9 V, a wiring mistake may be shorting the battery's positive terminal (G..L, 1) to (G..L, 3).
- c. If the voltage across (RED, any) and (BLACK, any) measures 9 V, a wiring mistake may be shorting the battery's positive terminal (G..L, 1) to either (G..L, 6) or to one of the red power connectors.
- d. If the problem still persists, contact Parallax Tech Support. (See page 18.)

4: I/O and Timing Basics Lab

Introduction

Most microcontroller applications involve reading inputs, making decisions, and controlling outputs. They also tend to be timing-sensitive, with the microcontroller determining when inputs are monitored and outputs are updated. The pushbutton circuits in this lab will provide simple outputs that the example applications can monitor with Propeller I/O pins set to input. Likewise, LED circuits will provide a simple and effective means of monitoring propeller I/O pin outputs and event timing.

While this lab's pushbutton and LED example applications might seem rather simple, they make it possible to clearly present a number of important coding techniques that will be used and reused in later labs. Here is a list of this lab's example applications and the coding techniques they introduce:

- **Turn an LED on** – assigning I/O pin direction and output state
- **Turn groups of LEDs on** – group I/O assignments
- **Signal a pushbutton state with an LED** – monitoring an input, and setting an output accordingly
- **Signal a group of pushbutton states with LEDs** – parallel I/O, monitoring a group of inputs and writing to a group of outputs
- **Synchronized LED on/off signals** – event timing based on a register that counts clock ticks
- **Configure the Propeller chip's system clock** – choosing a clock source and configuring the Propeller chip's Phase-Locked Loop (PLL) frequency multiplier
- **Display on/off patterns** – Introduction to more Spin operators commonly used on I/O registers
- **Display binary counts** – introductions to several types of operators and conditional looping code block execution
- **Shift a light display** – conditional code block execution and shift operations
- **Shift a light display with pushbutton-controlled refresh rate** – global and local variables and more conditional code block execution
- **Timekeeping application with binary LED display of seconds** – Introduction to synchronized event timing that can function independently of other tasks in a given cog.

Prerequisite Labs

- Setup and Testing

Parts List and Schematic

This lab will use six LED circuits and three pushbutton circuits.

- (6) LEDs – assorted colors
- (6) Resistors – 100 Ω
- (3) Resistor – 10 k Ω
- (3) Pushbutton – normally open
- (misc) jumper wires

- ✓ Build the schematic shown in Figure 4-1.

Figure 4-1: LED Pushbutton Schematic

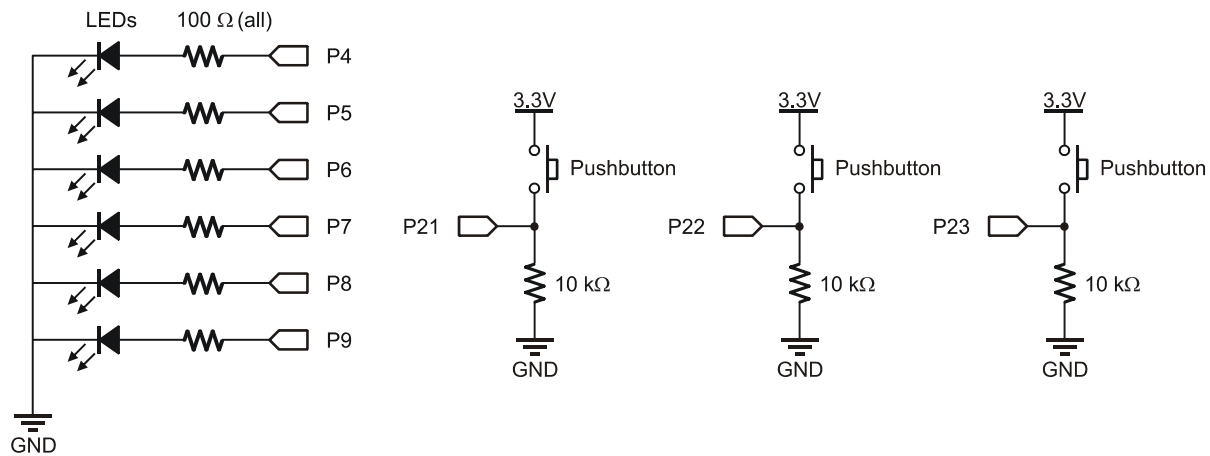

Propeller Nomenclature

The Propeller microcontroller's documentation makes frequent references to cogs, Spin, objects, methods, and global and local variables. Here are brief explanations of each term:

- **Cog** – a processor inside the Propeller chip. The Propeller chip has eight cogs, making it possible to perform lots of tasks in parallel. The Propeller is like a super-microcontroller with eight high speed 32-bit processors inside. Each internal processor (cog) has access to the Propeller chip's I/O pins and 32 KB of global RAM. Each cog also has its own 2 KB of RAM that can either run a Spin code interpreter or an assembly language program.
- **Spin language** – The Spin language is the high-level programming language created by Parallax for the Propeller chip. Cogs executing Spin code do so by loading a Spin interpreter from the Propeller chip's ROM. This interpreter fetches and executes Spin command codes that get stored in the Propeller chip's Global RAM.
- **Propeller cogs can also be programmed in low-level assembly language.** Whereas high-level Spin tells a cog what to do, low-level assembly language tells a cog how to do it. Assembly language generates machine codes that reside in a cog's RAM and get executed directly by the cog. Assembly language programs make it possible to write code that optimizes a cog's performance; however, it requires a more in-depth understanding of the Propeller chip's architecture. The PE Kit Fundamentals labs focus on Spin programming.
- **Method** – a block of executable Spin commands that has a name, access rule, and can optionally create local (temporary) variables, receive parameters, and return a value.
- **Global and local variables** – Global variables are available to all the methods in a given object, and they reserve variable space as long as an application is running. Local variables are defined in a method, can only be used within that method, and only exist while that method executes commands. When it's done, the memory these local variables used becomes available to other methods and their local variables. Local and global variables are defined with different syntax.
- **Object** – an application building block comprised of all the code in a given .spin file. Some Propeller applications use just one object but most use several. Objects have a variety of uses, depending partially on how they are written and partially on how they get configured and used by other objects. Some objects serve as top objects, which provide the starting point where the first command in a given application gets executed. Other objects are written to provide a library of useful methods for top objects or other objects to use.

Objects can be written to use just one cog, or can include code that gets launched into one or more additional cogs. Some objects have methods that provide a means to exchange information with processes running in other cogs. One object can even make multiple copies of another object, and set each one to a different task. Objects can use other objects, which in turn can use still other objects. In more complex applications, a set of objects will form functional relationships that can be viewed as a file structure with the Propeller Tool's Object Info window.

The examples in this lab only involve single, top-level objects with just one method. Upcoming labs will introduce various building-block techniques for using multiple objects and methods in an application, as well as parallel multiprocessing applications using multiple cogs. Though the objects in this lab are simple, many of them will be modified later to serve as building blocks for other objects and/or future projects.

Lights on with Direction and Output Register Bits

The LedOnP4 object shown below has a method named `LedOn`, with commands that instruct a cog in the Propeller chip to set its P4 I/O pin to output-high. This in turn causes the LED in the circuit connected to P4 to emit light.

- ✓ Load LedOnP4 into RAM by clicking *Run* → *Compile Current* → *Load RAM* (or press F10).

```
`` File: LedOnP4.spin
PUB LedOn                               ' Method declaration
    dira[4] := 1                         ' Set P4 to output
    outa[4] := 1                         ' Set P4 high
    repeat                               ' Endless loop prevents program from ending
```

How LedOnP4.spin Works

The first line in the program is a documentation comment. Single-line documentation comments are denoted by two apostrophes (not a quotation mark) to the left of the documentation text.

- ✓ Click the Documentation radio button above the code in the Propeller Editor.

While commands like `dira :=...` and `repeat` don't show in documentation mode, notice that the text to the right of the double apostrophe documentation comments does appear. Notice also that the non-documentation comments in the code, preceded by single apostrophes, do not appear in Documentation mode.

- ✓ Try the other radio buttons and note what elements of the object they do and do not show.



Block Comments: There are also documentation block comments that can span multiple lines. They have to begin and end with double-braces like this: `{{ block of documentation comments }}`. Non-documentation comments can also span multiple lines, beginning and ending with single-braces like this: `{ block of non-documentation comments }`.

All Spin language commands that the Propeller chip executes have to be contained within a *method block*. Every method block has to be declared with at least an access rule and a name. Access rules and method names will be explored in depth in upcoming labs; for now, just keep in mind that `PUB LedOn` is a method block declaration with a public (`PUB`) access rule and the name `LedOn`.



Bold or not bold? In the discussion paragraphs, the Parallax font used in the Propeller Tool is also used for all text that is part of a program. The portions that are reserved words or operators will be in bold. The portions that are defined by the user, such as method, variable, and constant names and values, will not be in bold text. This mimics the Propeller Tool software's syntax highlighting Spin scheme. Code listings and snippets are not given the extra bolding. To see the full syntax-highlighted version, view it in the Propeller Tool with the Spin scheme. Go to *Edit*→*Preferences*→*Appearance* to find the *Syntax Highlighting Scheme* menu.

The **dira** register is one of several special purpose registers in cog RAM; you can read and write to the **dira** register, which stores I/O pin directions for each I/O pin. A 1 in a given **dira** register bit sets that I/O pin to output; a 0 sets it to input. The symbol “:=” is the Assignment operator; the command **dira**[4] := 1 assigns the value 1 to the **dira** register's Bit 4, which makes P4 an output. When an I/O pin is set to output, the value of its bit in the **outa** register either sets the I/O pin high (3.3 V) with a 1, or low (0 V) with a 0. The command **outa**[4] := 1 sets I/O pin P4 high. Since the P4 LED circuit terminates at ground, the result is that the LED emits light.



I/O Sharing among Cogs? Each cog has its own I/O Output (**outa**) and I/O Direction (**dira**) registers. Since our applications use only one cog, we do not have to worry about two cogs trying to use the same I/O pin for different purposes at the same time. When multiple cogs are used in one application, each I/O pin's direction and output state is the “wired-OR” of the entire cogs collective. How this works logically is described in the I/O Pin section in Chapter 1 of the Propeller Manual.

The **repeat** command is one of the Spin language's conditional commands. It can cause a block of commands to execute repeatedly based on various conditions. For **repeat** to affect a certain block of commands, they have to be below it and indented further by at least one space. The next command that is not indented further than **repeat** is not part of the block, and will be the next command executed after the **repeat** loop is done.

Since there's nothing below the **repeat** command in the **LedOnP4** object, it just repeats itself over and over again. This command is necessary to prevent the Propeller chip from automatically going into low power mode after it runs out of commands to execute. If the **repeat** command weren't there, the LED would turn on too briefly to see, and then the chip would go into low power mode. To our eyes it would appear that nothing happened.

Modifying LedOnP4

More than one assignment can be made on one line.

- ✓ Replace this:

```
dira[4] := 1
outa[4] := 1
```

...with this:

```
dira[4] := outa[4] := 1
```

Of course, you can also expand the **LedOn** method so that it turns on more than one LED.

- ✓ Modify the **LedOn** method as shown here to turn on both the P4 and P5 LEDs:

PUB **LedOn**

```
dira[4] := outa[4] := 1
dira[5] := outa[5] := 1
repeat
```

If the `repeat` command was not the last command in the method, the LEDs would turn back off again so quickly that it could not be visually discerned as on for any amount of time. Only an oscilloscope or certain external circuits would be able to catch the brief “on” state.

- ✓ Try running the program with the `repeat` command commented with an apostrophe to its left.
- ✓ If you have an oscilloscope, set it to capture a single edge, and see if you can detect the signal.

I/O Pin Group Operations

The Spin language has provisions for assigning values to groups of bits in the `dira` and `outa` registers. Instead of using a single digit between the brackets next to the `outa` command, two values separated by two dots can be used to denote a contiguous group of bits. The binary number indicator `%` provides a convenient way of defining the bit patterns that get assigned to the group of bits in the `outa` or `dira` registers. For example, `dira[4..9] := %111111` will set bits 4 through 9 in the `dira` register (to output.) Another example, `outa[4..9] := %101010` sets P4, clears P5, sets P6, and so on. The result should be that the LEDs connected to P4, P6, and P8 turn on while the others stay off.

- ✓ Load `GroupIoSet.spin` into RAM (F10).
- ✓ Verify that the P4, P6, and P8 LEDs turn on.

```
'' File: GroupIoSet.spin
PUB LedsOn
    dira[4..9] := %111111
    outa[4..9] := %101010
    repeat
```

Modifying GroupIoSet.spin

Notice that `outa[4..9] := %101010` causes the state of the `outa` register’s bit 4 to be set (to 1), bit 5 cleared (to 0), and so on. If the pin group’s start and end values are swapped, the same bit pattern will cause bit 9 to be set, bit 8 to be cleared, and so on...

- ✓ Replace

```
    outa[4..9] := %101010
```

...with this

```
    outa[9..4] := %101010
```

- ✓ Load the modified program into the Propeller chip’s RAM and verify that the LEDs display a reversed bit pattern.

It doesn’t matter what value is in an `outa` register bit if its `dira` register bit is zero. That’s because the I/O pin functions as an input instead of an output when its `dira` register bit is cleared. An I/O pin functioning as an input detects high and low signals instead of sending them. While a pin configured to function as an output either transmits 3.3 or 0 V, a pin configured to input doesn’t transmit at all because it is instead monitoring the voltage applied to the pin.

An I/O pin set to output-high connected to an LED circuit turns the light on when it applies 3.3 V to the LED circuit. Since the other end of the LED circuit is connected to ground (0 V), the electrical

I/O and Timing Basics Lab

pressure across the LED circuit causes current to flow through the circuit, which turns the light on. An I/O pin set to output-low turns the light off because it applies 0 V to the LED circuit. With 0 V at both ends of the circuit, there is no electrical pressure across the circuit, so no current flows through it, and the light stays off. The light also stays off when the I/O pin is set to input, but for a different reason. An I/O pin set to input doesn't apply any voltage at all because it is instead sensing voltage applied to it by the circuit. The result is the same, the LED stays off.

Since an I/O pin set to input doesn't apply any voltage to a circuit, it doesn't matter what value is in the corresponding `outa` register bit. The LED circuit connected to that pin will remain off. Here is an example that sets all the bits in `outa[4..9]` but not all the bits in `dira[4..9]`. The LEDs connected to P6 and P7 will not turn on because their I/O pins have been set to input with zeros in the `dira` register.

- ✓ Set all the `outa[4..9]` bits.

```
outa[4..9] := %111111
```

- ✓ Clear bits 6 and 7 in `dira[4..9]`.

```
dira[4..9] := %110011
```

- ✓ Load the modified program into the Propeller chip's RAM and verify that the 1's in the `outa[6]` and `outa[7]` bits cannot turn on the P6 and P7 LEDs because their I/O pins have been set to inputs with zeros in `dira[6]` and `dira[7]`.

Reading an Input, Controlling an Output

The `ina` register is a read-only register in Cog RAM whose bits store the voltage state of each I/O pin. When an I/O pin is set to output, its `ina` register bit will report the same value as the `outa` register bit since `ina` bits indicate high/low I/O pin voltages with 1 and 0. If the I/O pin is instead an input, its `ina` register bit updates based on the voltage applied to it. If a voltage above the I/O pin's 1.65 V logic threshold is applied, the `ina` register bit stores a 1; otherwise, it stores a 0. The `ina` register is updated with the voltage states of the I/O pins each time an `ina` command is issued to read this register.

The pushbutton connected to P21 will apply 3.3 V to P21 when pressed, or 0 V when not pressed. In the `ButtonToLed` object below, `dira[21]` is set to 0, making I/O pin P21 function as an input. So, it will store 1 if the P21 pushbutton is pressed, or 0 if it is not pressed. By repeatedly assigning the value stored in `ina[21]` to `outa[6]`, the `ButtonLed` method makes the P6 LED light whenever the P21 pushbutton is pressed. Notice also that the command `outa[6] := ina[21]` is indented below the `repeat` command, which causes this line to get executed over and over again indefinitely.

- ✓ Load `ButtonToLed.spin` into RAM.
- ✓ Press and hold the pushbutton connected to P21 and verify that the LED connected to P6 lights while the pushbutton is held down.

```
'' File: ButtonToLed.spin
'' Led mirrors pushbutton state.

PUB ButtonLed                                ' Pushbutton/Led Method

  dira[6] := 1                                ' P6 → output
  dira[21] := 0                               ' P21 → input (this command is redundant)

  repeat                                     ' Endless loop
    outa[6] := ina[21]                       ' Copy P21 input to P6 output
```

Read Multiple Inputs, Control Multiple Outputs

A group of bits can be copied from the `ina` to `outa` registers with a command like `outa[6..4] := ina[21..23]`. The `dira[6] := 1` command will also have to be changed to `dira[6..4] := %111` before the pushbuttons will make the LEDs light up.

- ✓ Save a copy of `ButtonToLed`, and modify it so that it makes the P23, P22, and P21 pushbuttons light up the P4, P5 and P6 LEDs respectively. Hint: you need only one `outa` command.
- ✓ Try reversing the order of the pins in `outa[6..4]`. How does this affect the way the pushbutton inputs map to the LED outputs? What happens if you reverse the order of bits in `ina[21..23]`?

Timing Delays with the System Clock

Certain I/O operations are much easier to study with code that controls the timing of certain events, such as when an LED lights or how long a pushbutton is pressed. The three basic Spin building blocks for event timing are:

- `cnt` – a register in the Propeller chip that counts system clock ticks.
- `clkfreq` – a command that returns the Propeller chip's system clock frequency in Hz. Another useful way to think of it is as a value that stores the number of Propeller system clock ticks in one second.
- `waitcnt` – a command that waits for the `cnt` register to get to a certain value.

The `waitcnt` command waits for the `cnt` register to reach the value between its parentheses. To control the amount of time `waitcnt` waits, it's best to add the number of clock ticks you want to wait to `cnt`, the current number of clock ticks that have elapsed.

The example below adds `clkfreq`, the number of clock ticks in 1 second, to the current value of `cnt`. The result of the calculation between the parentheses is the value the `cnt` register will reach 1 s later. When the `cnt` register reaches that value, `waitcnt` lets the program move on to the next command.

```
waitcnt(clkfreq + cnt)      ' wait for 1 s.
```

To calculate delays that last for fractions of a second, simply divide `clkfreq` by a value before adding it to the `cnt` register. For example, here is a `waitcnt` command that delays for a third of a second, and another that delays for 1 ms.

```
waitcnt(clkfreq/3 + cnt)   ' wait for 1/3 s
waitcnt(clkfreq/1000 + cnt) ' wait for 1 ms
```

The `LedOnOffP4.spin` object uses the `waitcnt` command to set P4 on, wait for $\frac{1}{4}$ s, turn P4 off, and wait for $\frac{3}{4}$ s. The LED will flash on/off at 1 Hz, and it will stay on for 25 % of the time.

```
'' File: LedOnOffP4.spin
PUB LedOnOff
  dira[4] := 1
  repeat
    outa[4] := 1
    waitcnt(clkfreq/4 + cnt)
    outa[4] := 0
    waitcnt(clkfreq/4*3 + cnt)
```

- ✓ Load LedOnOffP4 object into the Propeller chip's RAM and verify that the light flashes roughly every second, on $\frac{1}{4}$ of the time and off $\frac{3}{4}$ of the time.

Remember that indentation is important! Figure 4-2 shows a common mistake that can cause unexpected results. On the left, all four lines below the `repeat` command are indented further than `repeat`. This means they are nested in the `repeat` command, and all four commands will be repeated. On the right, the lines below `repeat` are not indented. They are at the same level as the `repeat` command. In that case, the program never gets to them because the `repeat` loop does *nothing* over and over again instead!

Notice the faint lines that connect the "r" in `repeat` to the commands below it. These lines indicate the commands in the block that `repeat` operates on.

To enable this feature in the Propeller Tool software, click *Edit* and select *Preferences*. Under the *Appearance* tab, click the checkmark box next to *Show Block Group Indicators*. Or, use the shortcut key Ctrl+I.

Figure 4-2: Repeat Code Block
This repeat loop repeats four commands

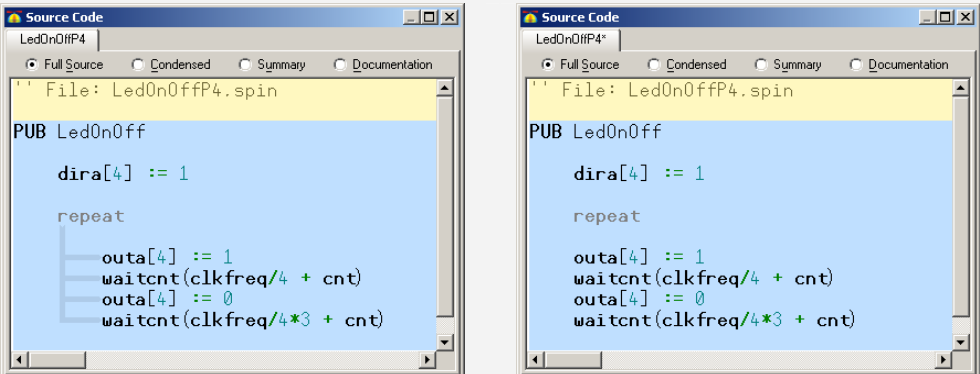

The commands below repeat are not indented further, so they are not part of the repeat loop.

Inside waitcnt(clkfreq + cnt)

When *Run* → *Compile Current* → *Load...* is used to download an object, the Propeller Tool software examines it for certain constant declarations that configure the Propeller chip's system clock. If the object does not have any such clock configuration constants, the Propeller Tool software stores default values in the Propeller chip's CLK register which set it to use the internal RC oscillator to fast mode (approximately 12 MHz) for the system clock. With the default 12 MHz system clock, the instruction `waitcnt(clkfreq + cnt)` is equivalent to the instruction `waitcnt(12_000_000 + cnt)`.

Figure 4-3 shows how `waitcnt(12_000_000 + cnt)` waits for the `cnt` register to accumulate 12 million more clock ticks than when the `waitcnt` command started. Keep in mind that the `cnt` register has been incrementing with every clock tick since the Propeller chip was either reset or booted. In this example, `cnt` reached the 50,000,008th clock tick at the point when the `waitcnt` command was executed. Then, the `cnt` value that `waitcnt` waits for is $12,000,000 + 50,000,008 = 62,000,008$. So, the cog executing `waitcnt(12_000_000 + cnt)` is not allowed to move on to the next command until the `cnt` register reaches the 62,000,008th clock tick.

Figure 4-3: The waitcnt Command and the cnt Register

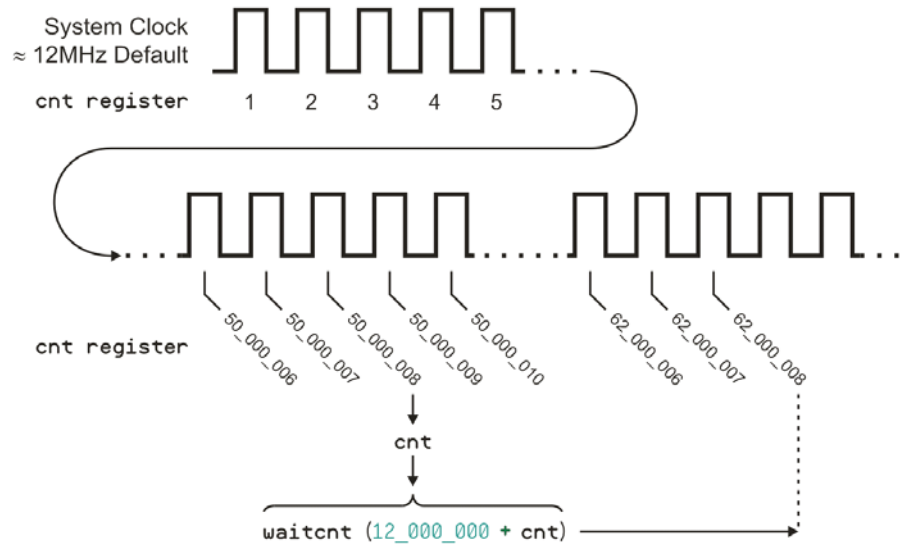

System Clock Configuration and Event Timing

Up to this point, our programs have been using the Propeller chip's default internal 12 MHz clock. Next, let's modify them to use the external 5.00 MHz oscillator in our PE Platform circuit. Both Spin and Propeller Assembly have provisions for declaring constants that configure the system clock and making sure that all the objects know its current operating frequency. The **CON** block designator defines a section of code for declaring Propeller configuration settings, as well as global constant symbols for program use.

Declarations similar to ones in the **CON** block below can be added to a top object to configure the Propeller chip's system clock. This particular set of declarations will make the Propeller chip's system clock run at top speed, 80 MHz.

```
CON
  _xinfreq = 5_000_000
  _clkmode = xtal1 + pll16x
```

The line `_xinfreq = 5_000_000` defines the expected frequency from the external oscillator, which in the PE Platform's case is 5.00 MHz. The line `_clkmode = xtal1 + pll16x` causes the Propeller Tool software's Spin compiler to set certain bits in the chip's CLK register when it downloads the program. (See the Propeller Manual for more information.) The `xtal1` clock mode setting configures certain XO and XI pin circuit characteristics to work with external crystals in the 4 to 16 MHz range.

The frequency of the external crystal provides the input clock signal which the Propeller chip's phase-locked loop (PLL) circuit multiplies for the system clock. `pll16x` is a predefined clock mode setting constant which makes the PLL circuit multiply the 5 MHz frequency by 16 to supply the system with an 80 MHz clock signal. The constant `pll8x` can be used with the same oscillator to run the Propeller chip's system clock at 40 MHz. `pll4x` will make the Propeller chip's system clock run at 20 MHz, and so on. The full listing of valid `_clkmode` constant declarations can be found in the Propeller Manual's Spin Language Reference `_CLKMODE` section.

Crystal Precision

The Propeller chip's internal RC clock serves for non-timing-sensitive applications, such as controlling outputs based on inputs and blinking lights. For applications that are timing-sensitive like serial communication, tone generation, servo control, and timekeeping, the Propeller chip can be connected to crystal oscillators and other higher-precision external clock signals via its XI and XO pins.

The Propeller chip's internal oscillator in its default RCFast mode is what the Propeller chip uses if the program does not specify the clock source or mode. This oscillator's nominal frequency is 12 MHz, but its actual frequency could fall anywhere in the 8 to 20 MHz range. That's an error of +66 to -33%. Again, for applications that do not require precise timing, it suffices. On the other hand, an application like asynchronous serial communication can only tolerate a total of 5% error, and that's the sum of both the transmitter's and receiver's timing errors. In practical designs, it would be best to shoot for an error of less than 1%. By using an external crystal for the Propeller chip's clock source, the clock frequency can be brought well within this tolerance, or even within timekeeping device tolerances.



The PE Platform has an ESC Inc. HC-49US quartz crystal connected to the Propeller chip's XI and XO pins that can be used in most timing-sensitive applications. The datasheet for this part rates its room temperature frequency tolerance at +/- 30 PPM, meaning +/- 30 clock ticks for every million. That's a percent error of only +/- 0.003%. Obviously, this is more than enough precision for asynchronous serial communication, and it's also great for servo control and tone generation. It's not necessarily ideal for watches or clocks though; this crystal's error could cause an alarm clock or watch to gain or lose up to 2.808 s per day. This might suffice for datalogging or clocks that periodically check in with an atomic clock for updates. Keep in mind that to make the Propeller chip function with digital wristwatch precision, all it takes is a more precise oscillator.

The HC-49US datasheet also has provisions for temperature (+/- 50 PPM) and aging (+/- 5 PPM per year). Even after 5 years, and at its rated -10 to +70 °C, the maximum error would be 105 PPM, which is still only +/- 0.0105% error. That's still great for asynchronous serial communication, tone generation, and servo control, but again, an alarm clock might gain or lose up to 9 s per day.

Since `clkfreq` stores the system clock frequency, object code can rely on it for correct timing, regardless of the system clock settings. The `clkfreq` command returns the number of ticks per second based on the Propeller chip's system clock settings. For example, this `CON` block uses `_xinfreq = 5_000_000` and `_clkmode = xtal1 + pll16x`, so `clkfreq` will return the value of $5,000,000 \times 16$, which equals 80,000,000.

`ConstantBlinkRate.spin` can be configured to a variety of system clock rates to demonstrate how `clkfreq` keeps the timing constant regardless of the clock frequency.

- ✓ Load `ConstantBlinkRate.spin` into the Propeller chip's RAM (F10). The system clock will be running at 80 MHz.
- ✓ Verify that the blink rate is 1 Hz.
- ✓ Modify the `_clkmode` constant declaration to read `_clkmode = xtal1 + pll8x` to make the system clock run at 40 MHz, and load the program into RAM (F10).

```
'' File: ConstantBlinkRate.spin
```

```
CON
```

```
_xinfreq = 5_000_000  
_clkmode = xtal1 + pll16x
```

```
PUB LedOnOff
```

```
  dira[4] := 1
```

```
  repeat
```

```
    outa[4] := 1  
    waitcnt(clkfreq/2 + cnt)  
    outa[4] := 0  
    waitcnt(clkfreq/2 + cnt)
```

The Propeller chip's system clock is now running at 40 MHz. Is the LED still blinking on/off at 1 Hz?

- ✓ Repeat for `p114x`, `p112x`, and `p111x`. There should be no change in the blink rate at any of these system clock frequencies.

Timing with `clkfreq` vs. Timing with Constants

Let's say that a constant value is used in place of `clkfreq` to make the program work a certain way at one particular system clock frequency. What happens when the Propeller system clock frequency changes?

- ✓ Save a copy of the `ConstantBlinkRate` object as `BlinkRatesWithConstants.spin`.
- ✓ Make sure the PLL multiplier is set to `p111x` so that the system clock runs at 5 MHz.
- ✓ For a 1 Hz on/off signal, replace both instances of `clkfreq/2` with `2_500_000`. (The Propeller Tool accepts underscores, but not commas, in long numbers to make them more legible.)
- ✓ Load the object into the Propeller chip's RAM and verify that the LED blinks at 1 Hz.
- ✓ Next, change the PLL multiplier to `p112x`. Load the modified object into the Propeller chip's RAM. Does the light blink twice as fast? Try `p114x`, `p118x`, and `p1116x`.

When a constant value was used instead of `clkfreq`, a change in the system clock caused a change in event timing. This is why objects should use `clkfreq` when predictable delays are needed, especially for objects that are designed to be used by other objects. That way, the programmer can choose the best clock frequency for the application without having to worry about whether or not any of application's objects will behave differently.

More Output Register Operations

In the I/O Pin Group Operations section, binary values were assigned to groups of bits in the `dira` and `outa` registers. There are lots of shortcuts and tricks for manipulating groups of I/O pin values that you will see used in published code examples.

The Post-Set “`~~`” and Post-Clear “`~`” Operators

Below are two example objects that do the same thing. While the object on the left uses techniques covered earlier to set and clear all the bits in `dira[4..9]` and `outa[4..9]`, the one on the right does it differently, with the Post-Set “`~~`” and Post-Clear “`~`” operators. These operators come in handy when all the bits in a certain range have to be set or cleared.

```
''File: LedsOnOff.spin
''All LEDs on for 1/4 s and off
''for 3/4 s.

PUB BlinkLeds

  dira[4..9] := %111111

  repeat

    outa[4..9] := %111111
    waitcnt(clkfreq/4 + cnt)
    outa[4..9] := %000000
    waitcnt(clkfreq/4*3 + cnt)
```

```
''File: LedsOnOffAgain.spin
''All LEDs on for 1/4 s and off
''for 3/4 s with post set/clear.

PUB BlinkLeds

  dira[4..9]~~

  repeat

    outa[4..9]~~
    waitcnt(clkfreq/4 + cnt)
    outa[4..9]~
    waitcnt(clkfreq/4*3 + cnt)
```

- ✓ Load each program into the Propeller chip's RAM and verify that they function identically.

I/O and Timing Basics Lab

- ✓ Examine how the Post-Set operator replaces `:= %111111` and the Post-Clear operator replaces `:= %000000`.
- ✓ Try modifying both programs so that they only affect P4..P7. Notice that the Post-Set and Post-Clear operators require less maintenance since they automatically set or clear all the bits in the specified range.

The Bitwise Not “!” Operator

Here are two more example programs that do the same thing. This time, they both light alternate patterns of LEDs. The one on the left has familiar assignment operators in the `repeat` loop. The one on the right initializes the value of `outa[4..9]` before the `repeat` loop. Then in the `repeat` loop, it uses the Bitwise NOT “!” operator on `outa[4..9]`. If `outa[4..9]` stores `%100001`, the command `!outa[4..9]` inverts all the bits (1s become 0s, 0s become 1s). So, the result of `!outa[4..9]` will be `%011110`.

- ✓ Load each object into the Propeller chip’s RAM and verify that they function identically.
- ✓ Try doubling the frequency of each object.

```
''File: LedsOnOff50Percent.spin
''Leds alternate on/off 50% of
''the time.

PUB BlinkLeds

  dira[4..9]~~

  repeat

    outa[4..9] := %100001
    waitcnt(clkfreq/4 + cnt)
    outa[4..9] := %011110
    waitcnt(clkfreq/4 + cnt)
```

```
''File: LedsOnOff50PercentAgain.spin
''Leds alternate on/off 50% of
''the time with the ! operator.

PUB BlinkLeds

  dira[4..9]~~
  outa[4..9] := %100001

  repeat

    !outa[4..9]
    waitcnt(clkfreq/4 + cnt)
```

Register Bit Patterns as Binary Values

A range of bits in a register can be regarded as digits in a binary number. For example, in the instruction `outa[9..4] := %000000`, recall that `%` is the binary number indicator; `%000000` is a 6-bit binary number with the value of zero. Operations can be performed on this value, and the result placed back in the register. The `IncrementOuta` object below adds 1 to `outa[9..4]` each time through a `repeat` loop. The result will be the following sequence of binary values, displayed on the LEDs:

Binary Value	Decimal Equivalent
<code>%000000</code>	0
<code>%000001</code>	1
<code>%000010</code>	2
<code>%000011</code>	3
<code>%000100</code>	4
<code>%000101</code>	5
etc...	
<code>%111101</code>	61
<code>%111110</code>	62
<code>%111111</code>	63

- ✓ Load IncrementOuta.spin it into RAM.

```

'' File: IncrementOuta.spin
PUB BlinkLeds

  dira[9..4]~~
  outa[9..4]~

  repeat
    waitcnt(clkfreq/2 + cnt)      'change to (clkfreq + cnt) to slow down the loop
    outa[9..4] := outa[9..4] + 1

```

The loop starts by setting LED I/O pins to output with `dira[9..4]~~`. Next, `outa[9..4]~` clears all the bits in the `outa` register range 9.4 to `%000000`, binary zero. The first time through the `repeat` loop, 1 is added to it, the equivalent of `outa[9..4] := %000001`, which causes the P4 LED to light up. As the loop repeats indefinitely, the LED pattern cycles through every possible permutation.

The Increment “++” operator

The Increment “++” operator can be used instead of `+ 1` to increment a value. The command `outa[9..4]++` is equivalent to `outa[9..4] := outa[9..4] + 1`.

- ✓ Modify the `outa` command in the `repeat` loop to use only `outa[9..4]++`.
- ✓ Load the modified object into RAM. Do the LEDs behave the same way?

Conditional Repeat Commands

Syntax options for `repeat` make it possible to specify the number of times a block of commands is repeated. They can also be repeated `until` or `while` one or more conditions exist, or even to sweep a variable value `from` a *Start* value `to` a *Finish* value with an optional `step Delta`.

- ✓ Read the syntax explanation in the REPEAT section of the Propeller Manual's Spin Language Reference, if you have it handy.

Let's modify IncrementOuta.spin further to stop after the last value (`%111111 = 63`) has been displayed. To limit the loop to 63 cycles just add an optional *Count* expression to the `repeat` command, like this:

```
repeat 63
```

- ✓ Save IncrementOuta.spin as BinaryCount.spin.
- ✓ Add the *Count* value 63 after the `repeat` command.
- ✓ To keep the LEDs lit after the `repeat` block terminates, add a second `repeat` command below the block. Make sure it is not indented further than the first `repeat`.
- ✓ Load the BinaryCount object into the Propeller chip's RAM and verify that the LEDs light up according to the Binary Value sequence.

There are a lot of different ways to modify the `repeat` loop to count to a certain value and then stop. Here are a few `repeat` loop variations that count to decimal 20 (binary `%010100`); the second example uses the Is Equal “`==`” operator, the third uses the Is Less Than “`<`” operator.

```

repeat 20          ' Repeat loop 20 times
repeat until outa[9..4] == 20  ' Repeat until outa[9..4] is equal to 20
repeat while outa[9..4] < 20  ' Repeat while outa[9..4] is less than 20

```

Operations in Conditions and Pre and Post Operator Positions

(11 more ways to count to 20)

The `outa[9..4]++` command can be removed from the code block in the `repeat` loop and incremented right inside the `repeat` command conditions. The `IncrementUntilCondition.spin` object shows an example that counts to 20 with `outa[9..4]` incremented by `++` right in the `repeat` loop's condition.

```
'' File: IncrementUntilCondition.spin
PUB BlinkLeds
  dira[4..9]~~
  repeat until outa[9..4]++ == 19
    waitcnt(clkfreq/2 + cnt)
  repeat
```



outa and **dira** initialize to zero when the program starts, so there is no need to include `outa[9..4]~`.

- ✓ Load `IncrementUntilCondition.spin` into the Propeller and verify that it counts to 20.

Note that the loop repeats until 19, but the program actually counts up to 20. Another way to use `++` in the `repeat` loop's condition is to place it before `outa[9..4]`, like this:

```
repeat until ++outa[9..4] == 20
```

Modify the `IncrementUntilCondition` object's `repeat` command, with its condition being `until ++outa[9..4] == 20`. Verify that it still stops counting at 20.

What's the difference? If the `++` is placed to the left of `outa[9..4]`, it is typically called Pre-Increment and the operation is performed before the `++outa[9..4] ==...` condition is evaluated. (The operator “--” placed to the left called Pre-Decrement.) Likewise, if `++` or `--` is placed to the right of `outa[9..4]`, it is typically called Post-Increment or Post-Decrement, and the operation is performed after the condition is evaluated.

With `repeat until outa[9..4]++ == 19`, the loop delays at `waitcnt` when `outa[9..4]` stores 0, 1, 2...19. When `outa[9..4]` stores 19, the loop does not repeat the `waitcnt`. However, since the post-incrementing occurs after the condition is evaluated, another 1 gets added to `outa[9..4]` even though the loop doesn't get repeated again.

With `repeat until ++outa[9..4] == 20`, `outa[9..4]` is pre-incremented, so the first delay doesn't occur until after `outa[9..4]` gets bumped up to 1. The next delay occurs after 2, 3, and so on up through 19. The next repetition, `outa[9..4]` becomes 20, so `waitcnt` command inside the loop does not execute, but again, the last value that `outa[9..4]` holds is 20.

Instead of repeating `until` a condition is true, a loop can be repeated `while` a condition is true. Here are examples that count to 20 using the `while` condition, with Post- and Pre-Increment operators adding 1 to `outa[9..4]`:

```
repeat while outa[9..4]++ < 19    ' Repeat while outa[9..4] post-incremented is less
                                  ' than 19.
repeat while ++outa[9..4] < 20    ' Repeat while outa[9..4] pre-incremented is less
                                  ' than 20.
```

Notice that the post-incremented loop counts to 20, repeating while `outa[9..4]` is less than 19, but the pre-incremented version repeats while `outa[9..4]` is less than 20. Notice that with `repeat while...`, the Is Less Than “<” operator is used instead of the Is Equal “==” operator. These two approaches demonstrate the distinction between repeating *until* something is equal to a value as opposed to repeating *while* something is less than a value.

Of course, you could also use the Is Equal or Less “<=” operator, or even the Is Not Equal “<>” operator. Here are examples of those; in each case the LED display will stop at binary 20.

```
repeat while outa[9..4]++ <= 18   ' Repeat while outa[9..4] post-incremented is less
                                  ' than or equal to 18.
repeat while ++outa[9..4] <= 19   ' Repeat while outa[9..4] pre-incremented is less
                                  ' than 19.
repeat while ++outa[9..4] <> 20   ' Repeat while outa[9..4] pre-incremented is not
                                  ' equal to 20.
```

Is Greater “>” or even Is Equal or Greater “>=” also be used with `repeat until...`

```
repeat until outa[9..4]++ > 18    ' Repeat until outa[9..4] post-incremented is
                                  ' greater than 18.
repeat until ++outa[9..4] > 19    ' Repeat until outa[9..4] pre-incremented is
                                  ' greater than 19.
repeat until ++outa[9..4] => 20   ' Repeat until outa[9..4] pre-incremented is equal
                                  ' or greater than 20.
repeat until outa[9..4]++ => 19   ' Repeat until outa[9..4] post-incremented is equal
                                  ' or greater than 19.
```

- ✓ Examine each of the `repeat` commands and try each one in the `IncrementUntilCondition` object.

If there are any question marks in your brain about this, don’t worry right now. The point of this section is to demonstrate that there is a variety of ways to make comparisons and to increment values. Upcoming labs will include better ways to display each loop repetition so that you can test each approach.

More Repeat Variations with From...To...

(Or, Another 3 Ways to Count to 20)

Here is one more condition for `repeat`, repeating `outa[9..4]` *from* one value *to* another value. With each repetition of the loop, this form of `repeat` automatically adds 1 to the count each time through. Take a look at the code snippet below. The first time through the loop, `outa[9..4]` starts at 0. The second time through, 1 is automatically added, and the condition is checked to make sure `outa[9..4]` is greater than or equal to 0 or less than or equal to 19. 1 is added each time through the loop. After the repetition where `outa[9..4]` is equal to 19, it adds 1 to `outa[9..4]`, making 20. Since 20 is not in the “from 0 to 19” range, the code in the loop does not execute.

```
repeat outa[9..4] from 0 to 19    ' Add 1 to outa[9..4] with each repetition
                                  ' start at 0 and count through 19.  Repeats Code
                                  ' block when outa[9..4] gets to 20.
```

I/O and Timing Basics Lab

Here is a **repeat** command that serves a similar function using **and**. It tests for two conditions, both of which must be true in order for the loop to repeat. Here we need to increment `outa[9..4]` within the loop block:

```
repeat while (outa[9..4] == 0) and (outa[9..4] <= 19)
    outa[9..4]++
```

Another nice thing about the **repeat...from...to...** form is you can use an optional **step** argument. For example, if you want to repeat what's in a loop with `outa[9..4]` at all even values, and exit the loop leaving `outa[9..4]` at 20, here's a way to do it:

```
Repeat outa[9..4] from 0 to 18 step 2
```

- ✓ Try the various **repeat** command variations in this section in the `IncrementUntilCondition` object.

Some Operator Vocabulary

Unary operators have one *operand*. For example, the Negate operator “-” in the expression `-1` is a unary operator, and `1` is the operand. *Binary* operators have two operands; for example, the Subtract operator “-” in the expression `x - y` is a binary operator, and both `x` and `y` are operands.

Normal operators, such as Add “+”, operate on their operands and provide a result for use by the rest of the expression without affecting the operand(s). Some operators we have used such as `:=`, `~~`, `~`, and `!` are *assignment operators*. Unary assignment operators, such as `~`, `~~`, and `++` write the result of the operation back to the operand whereas binary assignment operators, such as `:=`, assign the result to the operand to the immediate left. In both cases the result is available for use by the rest of the expression.

The *shift* operators Shift Right “>>” and Shift Left “<<” take the binary bit pattern of the value in the first operand and shift it to the right or the left by the number of bits specified by a second operand, and returns the value created by the new bit pattern. If an assignment form is used (`>>=` or `<<=`) the original value is overwritten with the result. The shift operators are part of a larger group, *Bitwise operators*, which perform various bit manipulations. The Bitwise NOT “!” operator we used earlier is an example.

Some normal and assignment operators have the additional characteristic of being a *comparison operator*. A comparison operator returns true (-1) if the values on both sides of the operator make the expression true, or false (0) if the values on both sides make the expression false. (These binary comparison operators are also called *Boolean* operators; there is also a unary Boolean operator, **NOT**.)

Conditional Blocks with **if**

As with many programming languages, Spin has an **if** command that allows a block of code to be executed conditionally, based on the outcome of a test. An **if** command can be used on its own, or as part of a more complex series of decisions when combined with **elseif**, **elseifnot** and **else**. Comparison operators are useful to test conditions in **if** statements:

```
if outa[9..4] == 0
    outa[9..4] := %100000

waitcnt(clkfreq/10 + cnt)
```

If the condition is true, the block of code (one line in this case) below it will be executed. Otherwise, the program will skip to the next command that's at the same level of indentation as the `if` statement (here it is `waitcnt`).

Shifting LED Display

The next example object, `ShiftRightP9toP4.spin`, makes use of several types of operators to efficiently produce a shifting light pattern with our 6 LED circuits.

- ✓ Load `ShiftRightP9toP4` into the Propeller chip's RAM.
- ✓ Orient your PE platform so that the light appears to be shifting from left to right over and over again.
- ✓ Verify that the pattern starts at P9 and ends at P4 before repeating.

```
'' File: ShiftRightP9toP4.spin
'' Demonstrates the right shift operator and if statement.

PUB ShiftLedsLeft

  dira[9..4] ~~

  repeat

    if outa[9..4] == 0
      outa[9..4] := %100000

    waitcnt(clkfreq/10 + cnt)
    outa[9..4] >>= 1
```

Each time through the `repeat` loop, the command `if [9..4] == 0` uses the `==` operator to compare `outa[9..4]` against the value 0. If the expression is true, the result of the comparison is -1. If it's false, the result is 0. Remember that by default `outa[9..4]` is initialized to zero, so the first time through the `repeat` loop `outa[9..4] == 0` evaluates to true. This makes the `if` statement execute the command `outa[9..4] := %100000`, which turns on the P9 LED.

After a 1/10 s delay, `>>=` (the Shift Right assignment operator) takes the bit pattern in `outa[9..4]` and shifts it right one bit with this instruction: `outa[9..4] >>= 1`. The rightmost bit that was in `outa[4]` is discarded, and the vacancy created in `outa[9]` gets filled with a 0. For example, if `outa[9..4]` stores `%011000` before `outa[9..4] >>= 1`, it will store `%001100` afterwards. If the command was `outa[9..4] >>= 3`, the resulting pattern would instead be `%000011`.

Each time through the loop, the `outa[9..4] >>= 1` command shifts the pattern to the right, cycling through `%100000`, `%010000`, `%001000`, ..., `%000001`, `%000000`. When `outa[9..4]` gets to `%000000`, the `if` command sees that `outa[9..4]` stores a 0, so stores `%100000` in `outa[9..4]`, and the shifting LED light repeats.

- ✓ Try changing the second operand in the shift right operation from 1 to 2, to make the pattern in `outa[9..4]` shift two bits at a time. You should now see every other LED blink from left to right.

Variable Example

The `ButtonShiftSpeed` object below is an expanded version of `ShiftRightP9toP4` that allows you to use pushbuttons to control the speed at which the lit LED shifts right. If you hold the P21 pushbutton down the shift rate slows down; hold the P22 pushbutton down and the shift rate speeds up. The speed control is made possible by storing a value in a variable. The pattern that gets shifted from left to right is also stored in a variable, making a number of patterns possible that cannot be achieved by performing shift operations on the bits in `outa[9..4]`.

- ✓ Load `ButtonShiftSpeed.spin` into RAM.
- ✓ Try holding down the P22 pushbutton and observe the change in the LED behavior, then try holding down the P21 pushbutton.

```
'' File: ButtonShiftSpeed.spin
'' LED pattern is shifted left to right at variable speeds controlled by pushbuttons.

VAR
    Byte pattern, divide

PUB ShiftLedsLeft

    dira[9..4] ~~
    divide := 5

    repeat

        if pattern == 0
            pattern := %11000000

        if ina[22] == 1
            divide ++
            divide <#= 254
        elseif ina[21] == 1
            divide --
            divide #>= 1

        waitcnt(clkfreq/divide + cnt)
        outa[9..4] := pattern
        pattern >>= 1
```

`ButtonShiftSpeed` has a variable (`VAR`) block that declares two byte-size variables, `pattern` and `divide`. The `pattern` variable stores the bit pattern that gets manipulated and copied to `outa[9..4]`, and `divide` stores a value that gets divided into `clkfreq` for a variable-length delay.

Byte is one of three options for variable declarations, and it can store a value from 0 to 255. Other options are **word** (0 to 65535) and **long** (-2,147,483,648 to 2,147,483,647). Variable arrays can be declared by specifying the number of array elements in brackets to the right of the variable name. For example, `byte myBytes[20]` would result in a 20-element array named `myBytes`. This would make available the variables `myBytes[0]`, `myBytes[1]`, `myBytes[2]`, ..., `myBytes[18]`, and `myBytes[19]`.

The first `if` block in the `repeat` loop behaves similarly to the one in the `ShiftRightP9toP4` object. Instead of `outa[9..4]`, the `if` statement examines the contents of the `pattern` variable, and if it's zero, the next line reassigns `pattern` the value `%11000000`.

The Limit Minimum “#>” and Limit Maximum “<#” Operators

Spin has Limit Minimum “#>” and Limit Maximum “<#” operators that can be used to keep the value of variables within a desired range as they are redefined by other expressions. In our example object, the second `if` statement in the `repeat` loop is part of an `if...elseif...` statement that checks the pushbutton states. If the P22 pushbutton is pressed, `divide` gets incremented by 1 with `divide ++`, and then `divide` is limited to 254 with `<#=`, the assignment form of the Limit Maximum operator. So, if `divide ++` resulted in 255, the next line, `divide <#= 254` reduces its value back to 254. This prevents the value of `divide` from rolling over to 0, which is important because `divide` gets divided into `clkfreq` in a `waitcnt` command later in the `repeat` loop. If the P21 pushbutton is pressed instead of P22, the `divide` variable is decremented with `divide --`, which subtracts 1 from `divide`. The `#>=` assignment operator is used to make sure that `divide` never gets smaller than 1, again preventing it from getting to 0.

After the `if...elseif...` statement checks the pushbutton states and either increments or decrements the `divide` variable if one of the pushbuttons is pressed, it uses `waitcnt(clkfreq/divide + cnt)` to wait for a certain amount of time. Notice that as `divide` gets larger, the time `waitcnt` waits gets smaller. After the `waitcnt` delay that’s controlled by the `divide` variable, `pattern` gets stored in `outa` with `outa[9..4] := pattern`. Last of all, the `pattern` variable gets shifted right by 1 for the next time through the loop.

Comparison Operations vs. Conditions

Comparison operators return true (-1) or false (0). When used in `if` and `repeat` blocks, the specified code is executed if the condition is non-zero. This being the case, `if ina[22]` can be used instead of `if ina[22] == 1`. The code works the same, but with less processing since the comparison operation gets skipped.

When the button is pressed, the condition in `if ina[22] == 1` returns -1 since `ina[22]` stores a 1 making the comparison true. Using just `if ina[22]` will still cause the code block to execute when the button is pressed since `ina[22]` stores 1, which is still non-zero, causing the code block to execute. When the button is not pressed, `ina[22]` stores 0, and `ina[22] == 1` returns false (0). In either case, the `if` statement’s condition is 0, so the code below either `if ina[22] == 0` or `if ina[22]` gets skipped.

- ✓ Change `if ina[22] == 1...elseif ina[21] == 1` to `if ina[22]...elseif ina[21]...`, and verify that the modified program still works.

Local Variables

While all the example objects in this lab have only used one method, objects frequently have more than one method, and applications typically are a collection of several objects. Methods in applications pass program control, and optionally parameters, back and forth between other methods in the same object as well as methods in other objects. In preparation for working with multiple methods in the next labs, let’s look at how a method can create a local variable.

Variables declared in an object’s `VAR` section are global to the object, meaning all methods in a given object can use them. Each method in an object can also declare local variables for its own use. These local variables only last as long as the method is being executed. If the method runs out of commands and passes program control back to whatever command called it, the local variable name and memory locations get thrown back in the heap for other local variables to use.

I/O and Timing Basics Lab

The two global variables in the ButtonShiftSpeed object can be replaced with local variables as follows:

- ✓ Remove the **VAR** block (including its byte variable declarations).
- ✓ Add the pipe | symbol to the right of the method block declaration followed by the two variable names separated by commas, then test the program verify it still functions properly.

```
PUB ShiftLedsLeft | pattern, divide
```

The `pattern` and `divide` variables are now local, meaning other methods in the object could not use them; since our object has just one method this is of no consequence here. There is one other difference. When we used the **VAR** block syntax, we had the option of defining our global variables as byte, word, or long in size. However, local variables are automatically defined as longs and there is no option for byte or word size local variables.

Timekeeping Applications

For clock and timekeeping applications, it's important to eliminate all possible errors, except for the accuracy of the crystal oscillator. Take a look at the two objects that perform timekeeping. Assuming you have a very accurate crystal, the program on the left has a serious problem! The problem is that each time the loop is repeated, the clock ticks elapsed during the execution of the commands in the loop are not accounted for, and this unknown delay accumulates along with `clkfreq + cnt`. So, the number of seconds the `seconds` variable will be off by will grow each day and will be significantly more than just the error introduced by the crystal's rated +/- PPM.

```
''File: TimekeepingBad.spin
CON
  _xinfreq = 5_000_000
  _clkmode = xtal1 + pll1x
VAR
  long seconds
PUB BadTimeCount
  dira[4]~~
  repeat
    waitcnt(clkfreq + cnt)
    seconds ++
    ! outa[4]
```

```
''File: TimekeepingGood.spin
CON
  _xinfreq = 5_000_000
  _clkmode = xtal1 + pll1x
VAR
  long seconds, dT, T
PUB GoodTimeCount
  dira[9..4]~~
  dT := clkfreq
  T := cnt
  repeat
    T += dT
    waitcnt(T)
    seconds ++
    outa[9..4] := seconds
```

The program on the right solves this problem with two additional variables: `T` and `dT`. A time increment is set with `dT := clkfreq` which makes `dT` equal to the number of ticks in one second. A particular starting time is marked with `T := cnt`. Inside the loop, the next `cnt` value that `waitcnt` has to wait for is calculated with `T += dT`. (You could also use `T := T + dT`.) Adding `dT` to `T` each time through the loop creates a precise offset from original marked value of `T`. With this system, each new target value for `waitcnt` is exactly 1 second's worth of clock ticks from the previous. It no longer matters how many tasks get performed between `waitcnt` command executions, so long as they take under 1 second to complete. So, the program on the right will never lose any clock ticks and maintain

a constant 1 s time base that's as good as the signal that the Propeller chip is getting from the external crystal oscillator.

i

Tip:

In `TimeKeepingGood.spin`, two lines:

```
T += dT
waitcnt(T)
```

can be replaced with this single line:

```
waitcnt(T += dT).
```

- ✓ Try running both objects. Without an oscilloscope, there should be no noticeable difference.
- ✓ Add a delay of 0.7 s to the end of each object (inside each repeat loop). The object on the left will now repeat every 1.7 s; the one on the right should still repeat every 1 s.

Instead of a delay, imagine how many other tasks the Propeller chip could accomplish in each second and still maintain an accurate time base!

Various multiples of a given time base can have different meanings and uses in different applications. For example, these objects have seconds as a time base, but we may be interested in minutes and hours. There are 60 seconds in a minute, 3,600 seconds in an hour and 86,400 seconds in a day. Let's say the application keeps a running count of `seconds`. A convenient way of determining whether another minute has elapsed is by dividing `seconds` by 60 to see if there is a remainder. The Modulus “//” operator returns the remainder of division problems. As the seconds pass, the result of `seconds // 60` is 0 when `seconds` is 0, 60, 120, 180, and so on. The rest of the time, the Modulus returns whatever is left over. For example, when `seconds` is 121, the result of `seconds // 60` is 1. When `seconds` is 125, the result of `seconds // 60` is 5, and so on.

This being the case, here's an expression that increments a `minutes` variable every time another 60 seconds goes by:

```
if seconds // 60 == 0
    minutes ++
```

Here's another example with hours:

```
if seconds // 3600 == 0
    hours ++
```

For every hour that passes, when `minutes` gets to 60, it should be reset to zero. Here is an example of a nested `if` statement that expands on the previous `minutes` calculation:

```
if seconds // 60 == 0
    minutes ++
    if minutes == 60
        minutes := 0
```

The `TimeCounter` object below uses synchronized timekeeping and a running total of seconds with the Modulus operator to keep track of seconds, minutes, hours, and days based on the `seconds` count. The value of `seconds` is displayed in binary with the 6 LED circuits. Study this program carefully, because it contains keys to this lab's projects that increment a time setting based in different durations of holding down a button. It also has keys to another project in which LEDs are blinked at different rates without using multiple cogs. (When you use multiple cogs in later labs, it will be a lot easier!)

I/O and Timing Basics Lab

- ✓ Load TimeCounter.spin into EEPROM, and verify that it increments the LED count every 1 s.
- ✓ Modify the code so that the last command copies the value held by `minutes` into `outa[9..4]`, and verify that the LED display increments every minute.

```
''File: TimeCounter.spin
CON
    _xinfreq = 5_000_000
    _clkmode = xtal1 + pll1x
VAR
    long seconds, minutes, hours, days, dT, T
PUB GoodTimeCount
    dira[9..4]~~
    dT := clkfreq
    T := cnt
    repeat
        T += dT
        waitcnt(T)
        seconds++
        if seconds // 60 == 0
            minutes++
            if minutes == 60
                minutes := 0
        if seconds // 3600 == 0
            hours++
            if hours == 24
                hours := 0
        if seconds // 86400 == 0
            days++
        outa[9..4] := seconds
```

Eventually, the `seconds` variable will reach variable storage limitations. For example, when it gets to 2,147,483,647, the next value will be -2,147,843,648, and after that, -2,147,843,647, -2,147,843,646, and so on down to -2, -1. So, how long will it take for the seconds counter to get to 2,147,483,647? The answer is 68 years. If this is still a concern for your application, consider resetting the second counter every year.

Study Time

Questions

- 1) How many processors does the PE Kit's Propeller microcontroller have?
- 2) How much global RAM does the Propeller microcontroller have?
- 3) What's the Propeller chip's supply voltage? How does this relate to an I/O pin's high and low states?
- 4) Where does the Propeller chip store Spin code, and how is it executed?
- 5) How does executing Spin codes differ from executing assembly language codes?
- 6) What's the difference between a method and an object?

- 7) What's a top object?
- 8) What do bits in the **dira** and **outa** registers determine?
- 9) Without optional arguments the **repeat** command repeats a block of code indefinitely. What types of optional arguments were used in this lab, and how did they limit the number of loop repetitions?
- 10) What Spin command used with **waitcnt** makes it possible to control timing without knowing the Propeller chip's system clock frequency in advance?
- 11) If commands are below a **repeat** command, how do you determine whether or not they will be repeated in the loop?
- 12) What was the most frequent means of calculating a target value for the **waitcnt** command, and what register does the **waitcnt** command compare this target value to?
- 13) What's the difference between **_xinfreq** and **_clkmode**?
- 14) What does the phase-locked loop circuit do to the crystal clock signal?
- 15) Why is it so important to use a fraction of **clkfreq** instead of a constant value for delays?
- 16) Which clock signal will be more accurate, the Propeller's internal RC clock or an external crystal?
- 17) What registers control I/O pin direction and output? If an I/O pin is set to input, what register's values will change as the application is running, and how are the values it returns determined by the Propeller?
- 18) What's the difference between **dira/outa/ina** syntax that refers to single bit in the register and syntax that denotes a group of bits?
- 19) What indicator provides a convenient means of assigning a group of bit values to a contiguous group of bits in a **dira/outa/ina** register?
- 20) How does an I/O pin respond if there is a 0 in its **dira** register bit and a 1 in its **outa** register bit?
- 21) If bits in either **dira** or **outa** are not initialized, what is their default value at startup?
- 22) What assignment operators were introduced in this lab?
- 23) What comparison operators were used in this lab?
- 24) What's the difference between the **:=** and **==** operators?
- 25) Are comparison operators necessary for if conditions?
- 26) What are the two different scopes a variable can have in an object?
- 27) What are the three different variable sizes that can be declared? What number range can each hold? Does the scope of a variable affect its size?
- 28) How does a method declare local variables? What character is required for declaring more than one local variable?

Exercises

- 1) Write a single line of code that sets P8 through P12 to output-high.
- 2) Write commands to set P9 and P13 through P15 to outputs. P9 should be made output-high, and P13 through P15 should be low.
- 3) Write a single initialization command to set P0 through P2 to output and P3 through P8 to input.
- 4) Write a **repeat** block that toggles the states of P8 and P9 every 1/100 s. Whenever P8 is on, P9 should be off, and vice versa.
- 5) Write a **repeat** loop that sets P0 through P7 to the opposite of the states sensed by P8 through P15. You may want to consult the Propeller Manual's list of assignment operators for the best option.
- 6) Write a **CON** block to make the Propeller chip's system clock run at 10 MHz.
- 7) Write code for a five-second delay.
- 8) Write code that sets P5 through P11 high for 3 seconds, then sets P6, P8, and P10 low. Assume the correct **dira** bits have already been set.

- 9) Write a method named `LightsOn` with a **repeat** loop that turns on P4 the first second, P5 the second, P6 the third, and so on through P9. Assume that the I/O pin direction bits have not been set. Make sure the lights stay on after they have all been turned on.
- 10) Write a method that turns an LED connected to P27 on for 5 s if a pushbutton connected to P0 has been pressed, even if the button is released before 5 s. Don't assume I/O directions have been set. Make sure to turn the P27 LED off after 5 s.
- 11) Write a second countdown method that displays on the P4 through P9 LEDs. It should count down from 59 to 0 in binary.
- 12) Write a second countdown method that displays on the P4 through P9 LEDs. It should count down from 59 to 0 in binary, over and over again, indefinitely.
- 13) Write a method named `PushTwoStart` that requires you to press the buttons connected to P21 and P23 at the same time to start the application. For now, the application can do as little as turn an LED on and leave it on.
- 14) Write a method named `PushTwoCountdown` that requires you to press the buttons connected to P21 and P23 at the same time to start the application. The application should count down from 59 to 0 using P9 through P4.

Projects

- 1) Connect red LEDs to P4 and P7, yellow LEDs to P5 and P8, and green LEDs to P6 and P9. Assume that one set of LEDs is pointing both directions on the north south street, and the other set is pointing both ways on the east west street. Write a non-actuated street controller object (one that follows a pattern without checking to find out which cars are at which intersections).
- 2) Repeat the previous project, but assume that the N/S street is busy, and defaults to green while the E/W street has sensors that trigger the lights to change.
- 3) Use a single cog to make LEDs blink at different rates (this is much easier with multiple cogs, as you will see in later labs). Make P4 blink at 1 Hz, P5 at 2 Hz, P6 at 3 Hz, P7 at 7 Hz, P8 at 12 Hz and P9 at 13 Hz.
- 4) Buttons for setting alarm clock times typically increment or decrement the time slowly until you have held the button down for a couple of seconds. Then, the time increments/decrements much more rapidly. Alarm clock buttons also let you increment/decrement the time by rapidly pressing and releasing the pushbutton. Write an application that lets you increase or decrease the binary count for minutes (from 0 to 59) with the P21 and P23 pushbuttons. As you hold the button, the first ten minutes increase/decrease every $\frac{1}{2}$ s, then if you continue to hold down the button, the minutes increase/decrease 6 times as fast. Use the P9 through P4 LEDs to display the minutes in binary.
- 5) Extend project 4 by modifying the object so that it is a countdown timer that gets set with the P21 and P23 buttons and started by the P22 button.

5: Methods and Cogs Lab

Introduction

Objects are organized into code building blocks called *methods*. In Spin, method names can be used to pass program control and optionally *parameter* values from one method to another. When one method uses another method's name to pass it program control, it's called a *method call*. When the called method runs out of commands, it automatically returns program control and a result value to the line of code in the method that called it. Depending on how a method is written, it may also receive one or more parameter values when it gets called. Common uses for parameter values include configuration, defining the method's behavior, and input values for calculations.

Methods can also be launched into separate cogs so that their commands get processed in parallel with commands in other methods. The Spin language has commands for launching methods into cogs, identifying cogs, and stopping cogs. When Spin methods are launched into cogs, global variable arrays have to be declared to allocate memory for the methods to store return addresses, return values, parameters, and values used in calculations. This memory is commonly referred to as a *stack space*.

This lab demonstrates techniques for writing methods, calling methods, passing parameters to methods, and returning values from methods. It also demonstrates using method calls in commands that launch instances of methods into separate cogs, along with an overview of estimating how much stack space will be required for one or more Spin methods that get executed by a given cog.

Prerequisite Labs

- Setup and Testing
- I/O and Timing Basics

Parts List and Schematic

This lab will use six LED circuits and three pushbutton circuits (the same as I/O and Timing Basics)

- (6) LEDs – assorted colors
- (6) Resistors – 100 Ω
- (3) Resistor – 10 k Ω
- (3) Pushbutton – normally open
- (misc) jumper wires

- ✓ Build the circuits shown in Figure 5-1.

Figure 5-1: LED Pushbutton Schematic

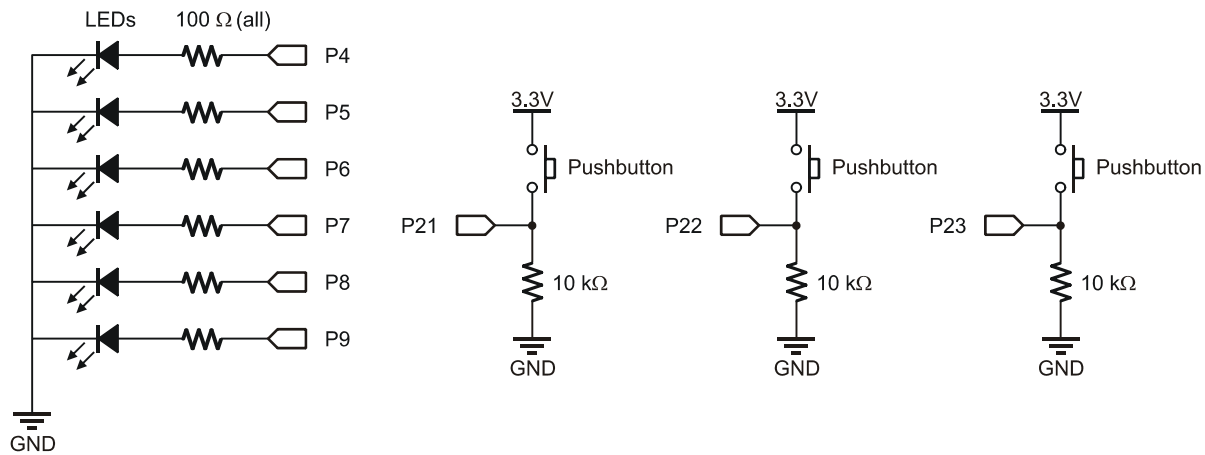

Defining a Method's Behavior with Local Variables

The `AnotherBlinker` object below uses three local variables, `pin`, `rate`, and `reps`, to define its `repeat` loop's LED on/off behavior. With the current variable settings, it makes P4 blink at 3 Hz for 9 on/off repetitions. Since the `repeat` loop only changes the LED state (instead of a complete on/off cycle), the object needs twice the number of state changes at half the specified delay between each state change. So, the `reps` variable has to be multiplied by 2 and `rate` has to be divided by 2. That's why the `repeat` loop repeats for `reps * 2` iterations instead of just `reps` iterations, and that's also why the `waitcnt` command uses `rate/2` instead of `rate` for the 3 Hz blink rate.

- ✓ Run the `AnotherBlinker.spin` object, and verify that it makes the P4 LED blink at 3 Hz for 9 repetitions.
- ✓ Try a variety of `pin`, `rate` and `reps` settings and verify that they correctly define the `repeat` loop's behavior.

```
'' AnotherBlinker.spin
PUB Blink | pin, rate, reps

  pin := 4
  rate := clkfreq/3
  reps := 9

  dira[pin]~~
  outa[pin]~

  repeat reps * 2
    waitcnt(rate/2 + cnt)
    !outa[pin]
```

Calling a Method

The `Blink` method is used again in the next example object, `CallBlink`, along with another method named `Main`. Figure 5-2 shows how the `Blink` method is called from within the `Main` method. Program execution begins at `Main`, the first `PUB` block. When the program gets to the `Blink` line in the `Main` method, program control gets passed to the `Blink` method. That's a minimal version of a method

call. When the `Blink` method is done blinking the LED 9 times, program control gets passed back to the `Blink` method call in the `Main` method. That's the *method return*, or just the "return."

Let's take a closer look at the `CallBlink` object's `Main` method. It starts by turning on the P9 LED, to let the user know that the P23 pushbutton can be pressed. The `repeat until ina[23]` loop keeps repeating itself until the P23 button is pressed and the program moves on, turning off the P9 LED with `outa[9] := 0`. Then, it calls the `Blink` method, which blinks P4 at 3 Hz for 9 reps, and then returns. The next command is `waitcnt(clkfreq/2*3 + cnt)` which pauses for 3/2 s. Then, the outermost `repeat` loop in the `Main` method starts its next iteration. At that point, the P9 LED turns on again, indicating that the P23 pushbutton can again trigger the P4, 3 Hz, 9 reps sequence.

- ✓ Load the `CallBlink.spin` object into the Propeller chip.
- ✓ When the P9 LED turns on, press/release the P23 pushbutton.
- ✓ Wait for the P9 LED to turn on again after the P4 LED has blinked 9 times.
- ✓ Press/release the P23 pushbutton again to reinitiate the sequence.

Figure 5-2: Calling a Method

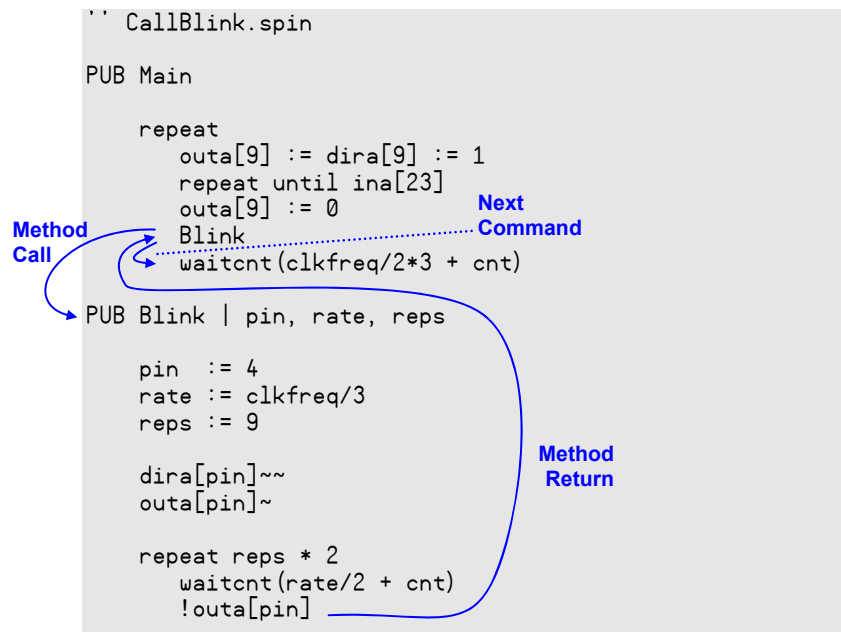

Parameter Passing

The `Blink` method we just used sets the values of its `pin`, `rate`, and `reps` local variables with individual `var := expression` instructions. To make methods more flexible and efficient to use, the value of their local variables can be defined in the method call instead of within the method itself.

Figure 5-3 below shows how this works in the `BlinkWithParams` object. The modified `Blink` method declaration now reads: `Blink(pin, rate, reps)`. The group of local variables between the parentheses is called the *parameter list*. Notice how the `Blink` method call in the `BlinkTest` method also has a parameter list. These parameter values get passed to the local variables in the `Blink` method declaration's parameter list. In this case, the `BlinkTest` passes 4 to `pin`, `clkfreq/3` to `rate`, and 9 to `reps`. The result is the same as the `AnotherBlinker` object, but now code in one method can pass values to local variables in another method.

Methods and Cogs Lab

- ✓ Load `BlinkWithParams.spin` into the Propeller chip and verify that the result is the same the previous `AnotherBlinker` object.
- ✓ Try adjusting the parameter values in the method call to adjust the `Blink` method's behavior.

Figure 5-3: Parameter Passing

```
'' BlinkWithParams.spin
PUB BlinkTest
    Blink(4, clkfreq/3, 9)
    Blink(5, clkfreq/7, 21)
    Blink(6, clkfreq/11, 39)

PUB Blink( pin, rate, reps)
    dira[pin]~~
    outa[pin]~

    repeat reps * 2
        waitcnt(rate/2 + cnt)
        !outa[pin]
```

Methods can be re-used with different parameter values in each method call; here `Blink` is called three times with different parameters, and a 1 s pause in between.

```
PUB BlinkTest

    Blink(4, clkfreq/3, 9)
    waitcnt(clkfreq + cnt)
    Blink(5, clkfreq/7, 21)
    waitcnt(clkfreq + cnt)
    Blink(6, clkfreq/11, 39)
```

Here is another example that blinks a different LED each time the pushbutton is pressed and released. This is a variation of the `CallBlink` object's `Main` method, with a local variable named `led` and a `repeat` loop that sets the `led` variable to 4, 5, ..., 8, 9, 4, 5, ...8, 9, An updated `Blink` method call passes the value in the `led` variable to the `Blink` method's `pin` parameter. Since `led` changes with each iteration of the `repeat led... loop`, the `pin` variable will receive a different value each time `Blink` is called. The result? Each time the pushbutton is pressed (after P9 lights up), a different LED will blink at 3 Hz for 9 reps.

```
PUB BlinkTest | led
    repeat
        repeat led from 4 to 9
            outa[9] := dira[9] := 1
            repeat until ina[23]
                outa[9] := 0
                Blink(led, clkfreq/3, 9)
                waitcnt(clkfreq/2*3 + cnt)
```

The `BlinkTest` method's local variable `led` could have been named `pin` because it's a local variable, so only code in the `BlinkTest` method uses it. Code in the `Blink` method also has a local variable `pin`, but again, only code in the `Blink` method will be aware of that `pin` variable's value.

- ✓ Try the two modified versions of `BlinkTest` just discussed and make sure they make sense.
- ✓ Try changing the parameters so that the P4 LED blinks four times, P5 blinks 5 times, and so on.

Launching Methods into Cogs

All the methods in the objects up to this point have executed in just one of the Propeller chip's cogs, Cog 0. Each time the `Blink` method was called, it was called in sequence, so the LEDs blinked one at a time. The `Blink` method can also be launched into several different cogs, each with a different set of parameters, to make the LEDs all blink at different rates simultaneously. The `BlinkWithCogs` object shown in Figure 5-4 demonstrates how to do this with three `cognew` commands.

The first method in a top object automatically gets launched into Cog 0, so the `Blinker` object's `LaunchBlinkerCogs` method starts in Cog 0. It executes three `cognew` commands, and then runs out of instructions, so Cog 0 shuts down. Meanwhile, three other cogs have been started, each of which runs for about three seconds. After the last cog runs out of commands, the Propeller chip goes into low power mode.

Figure 5-4: Launching Methods Into Cogs with Parameter Passing

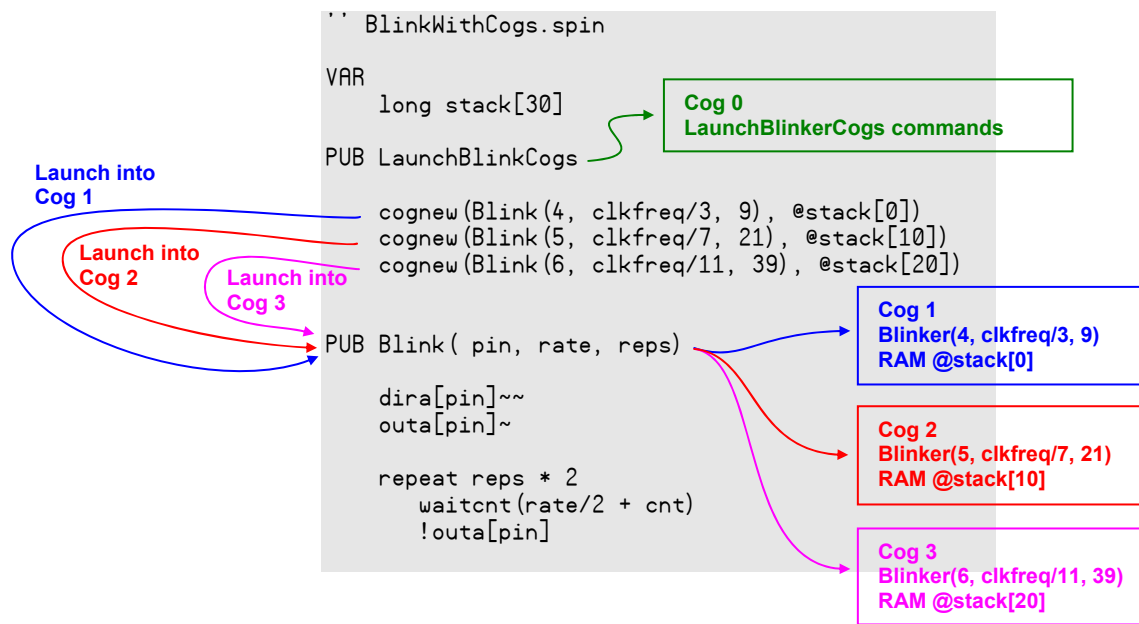

While Cog 0 accesses unused Global RAM that comes after the program codes to store method call return addresses, local variables and intermediate expression calculations, other cogs that execute Spin methods have to have variables set aside for them. Such variable space reserved in Global RAM for those temporary storage activities is called *stack space*, and the data stored there at any given moment is the *stack*. Notice that the `BlinkWithCogs` object in Figure 5-4 has a `long stack[30]` variable declaration. This declares an array of long variables named `stack` with 30 elements: `stack[0]`, `stack[1]`, `stack[2]`, ..., `stack[28]`, `stack[29]`.

The command `cognew(Blink(4, clkfreq/3, 9), @stack[0])` calls the `Blink` method with the parameters 4, `clkfreq/3`, and 9 into the next available cog, which happens to be Cog 1. The `@stack[0]` argument passes the address of the `stack[0]` array element to Cog 1. So Cog 1 starts executing `Blink(4, clkfreq/3, 9)` using `stack[0]` and upward for its return address, local variables, and intermediate calculations. The command `cognew(Blink(5, clkfreq/7, 21), @stack[10])` launches `Blink(5, clkfreq/7, 21)` into Cog 2, with a pointer to `stack[10]`'s address in RAM so it uses from `stack[10]` and upwards. Then `cognew(Blink(6, clkfreq/11, 39), @stack[20])` does it again with different `Blink` method parameters and a different address in the `stack` array.

Methods and Cogs Lab

- ✓ Load the BlinkWithCogs object into the Propeller chip and verify that it makes the three LEDs blink at different rates at the same time (instead of in sequence).
- ✓ Examine the program and make notes of the new elements.

The unused RAM that Cog 0 uses for its stack can be viewed with the Object Info window shown in Figure 5-5 (F8, then *Show Hex.*) The gray color-coded bytes at the top are initialization codes that launch the top object into a cog, set the Propeller chip's CLK register, and various other initialization tasks. The red memory addresses store Spin program codes, the yellow indicates global variable space (the 30-long variable `stack` array). What follows is blue unused RAM, some of which will be used by Cog 0 for its stack. The beginning RAM address of Cog 0's stack space is hexadecimal 00F0.

Figure 5-5: Object Info Window

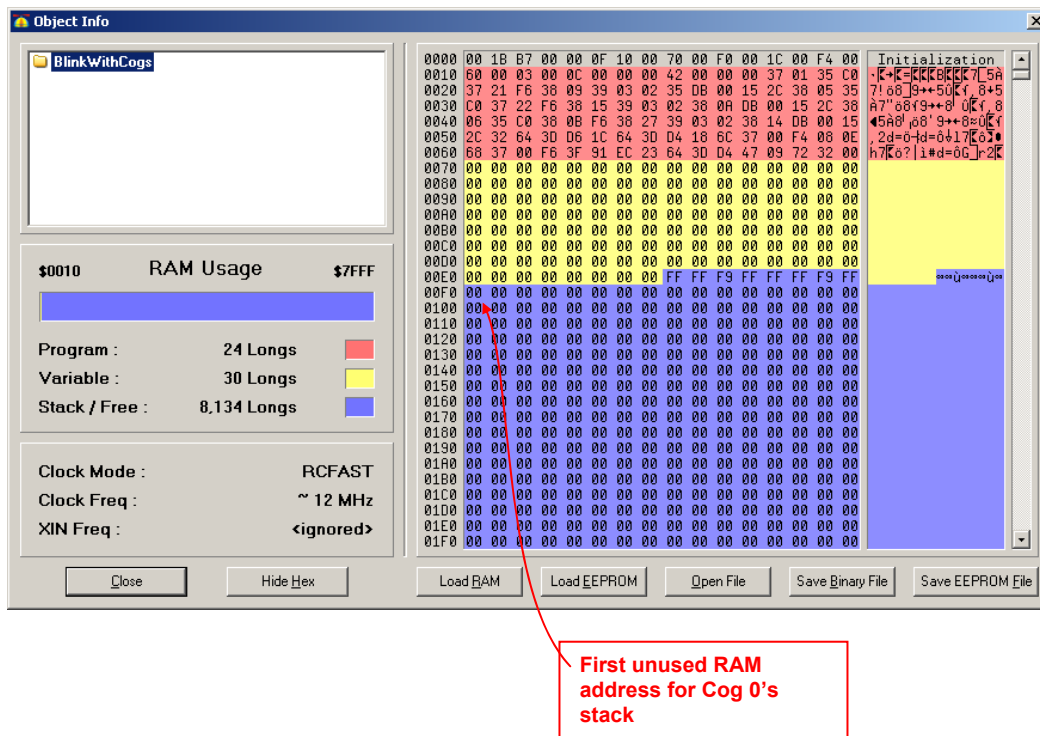

Stopping Cogs

With `cognew` commands, the Propeller chip always looks for the next available cog and starts it automatically. In the BlinkWithCogs object, the pattern of cog assignments is predictable: the first `cognew` command launches `Blink` (4, `clkfreq/3`, 9) into Cog 1, `Blink` (5, `clkfreq/7`, 21) into Cog 2, and `Blink` (6, `clkfreq/11`, 39) into Cog 3.

Choose your Cog: Instead of using the next available cog, you can specify which cog you wish to launch by using the `coginit` command instead of `cognew`. For example, this command will launch the `Blink` method into Cog 6:

```
coginit(6, Blink(4, clkfreq/3, 9), @stack[0])
```

The `cogstop` command can be used to stop each of these cogs. Here is an example with each `reps` parameter set so that the object will keep flashing LEDs until one million repetitions have elapsed. After a 3 second delay, `cogstop` commands shut down each cog at one-second intervals using the predicted cog ID so that none of the methods get close to executing one million reps.

PUB LaunchBlinkCogs

```
cognew(Blink(4, clkfreq/3, 1_000_000), @stack[0])
cognew(Blink(5, clkfreq/7, 1_000_000), @stack[10])
cognew(Blink(6, clkfreq/11, 1_000_000), @stack[20])
waitcnt(clkfreq * 3 + cnt)
cogstop(1)
waitcnt(clkfreq + cnt)
cogstop(2)
waitcnt(clkfreq + cnt)
cogstop(3)
```

With some indexing tricks, the cogs can even be launched and shut down with **repeat** loops. Below is an example that uses an `index` local variable in a **repeat** loop to define the I/O pin, stack array element, and cog ID. It does exactly the same thing as the modified version of the `LaunchBlinkCogs` method above. Notice that the local variable `index` is declared with the pipe symbol. Then, **repeat** `index` from 0 to 2 increments `index` each time through the three `cognew` command executions. When `index` is 0, the `Blink` method call's `pin` parameter is `0 + 4`, passing 4 to the `Blink` method's `pin` parameter. The second time through, `index` is 1, so `pin` becomes 5, and the third time through, it makes `pin` 6. For the `clkfreq` sequence of 3, 7, 11 with `index` values of 0, 1, and 2, $(\text{index} * 4) + 3$ fits the bill. For 0, 10, and 20 as the array element, `index * 10` fits the bill. To stop cogs 1, 2, and 3, the second **repeat** loop sweeps `index` from 1 to 3. The first time through the loop, `index` is 1, so `cogstop(index)` becomes `cogstop(1)`. The second time through, `index` is 2, so `cogstop(2)`, and the third time through, `index` is 3 resulting in `cogstop(3)`.

```
PUB LaunchBlinkCogs | index
  repeat index from 0 to 2
    cognew(Blink(index + 4, clkfreq/((index*4) + 3), 1_000_000), @stack[index * 10])

  waitcnt(clkfreq * 3 + cnt)

  repeat index from 1 to 3
    cogstop(index)
    waitcnt(clkfreq + cnt)
```

✓ Try the modified versions of the `LaunchBlinkCogs` methods.

Objects can be written so that they keep track of which cog is executing a certain method. One approach will be introduced in the Cog ID Indexing section on page 76. Other approaches will be introduced in the upcoming Objects lab.

How Much Stack Space for a Method Launched into a Cog?

Below is a list of the number of longs each method adds to the stack when it gets called.

- 2 – return address
- 1 – return result
- number of method parameters
- number of local variables
- workspace for intermediate expression calculations

Assume you have an object with three methods: A, B and C. When method A calls method B, the stack will grow, containing two sets of these longs, one for method A, and one for method B. If method B calls method C, there will be a third set. When method C returns, the stack drops down to two sets.

Methods and Cogs Lab

The workspace is for storing values that exist during certain tasks and expression evaluations. For example, the `Blink` method's `repeat reps * 2` uses the workspace in two different ways. First, the `reps * 2` expression causes two elements to be pushed to the stack: the value stored by `reps` and 2. After the `*` calculation, 2 is popped from the stack, and the result of the calculation is stored in a single element. This element stays on the stack until the `repeat` loop is finished. Inside the `repeat reps * 2` loop, two similar expansions and contractions of the stack occur with `waitcnt(rate/2 + cnt)`, first with `rate/2`, and again when the result of `rate/2` is added to `cnt`.

In this case of the `Blink` method, the most it uses for workspace and intermediate expression calculations is 3 longs: one long for holding the result of `reps * 2` until the `repeat` loop is done, and two more for the various calculations with binary operators such as multiply (`*`) and divide (`/`). Knowing this, we can tally up the number of long variables a cog's stack will need to execute this method are listed below. So, the total amount of stack space (i.e. number of long variables) a cog needs to execute the `Blink` method is 10.

- 2 – return address
 - 1 – result variable (every method has this built-in, whether or not a return value is specified. This will be introduced in the next section.)
 - 3 – `pin`, `freq`, and `reps` parameters
 - 1 – `time` local variable
 - 3 – workspace for calculations.
-
- 10 – Total

As mentioned earlier, one cog needs enough stack space to for all the memory it might use, along with all the stack space of any method it calls. Some methods will have nested method calls, where method A calls method B, which in turn calls method C. All those methods would need stack memory allocated if method A is the one getting launched into the cog.



Err on the side of caution: The best way to set aside stack space for a cog that gets a Spin method launched into it is to err on the side of caution and declare way more memory that you think you'll need. Then, you can use an object in the Propeller Tool's object library (the folder the Propeller.exe file lives in) named `Stack Length.spin` to find out how many variables the method actually used. The Objects Lab will feature a project that uses the `Stack Length` object to verify the number of long variables required for a Spin method that gets launched into a cog.

Declaring a long variable array named `stack` in an object's `VAR` code block is a way of setting aside extra RAM for a cog that's going to run a Spin interpreter. The name of the array doesn't have to be `stack`; it just has to be a name the Spin language can use for variable name. The names `blinkStack` or `methodStack` would work fine too, so long as the name that is chosen is also the one whose address gets passed to the cog by the `cognew` command. Remember that the `@` operator to the left of the variable name is what specifies the variable's Global RAM address.



About `_STACK`: The Spin language also has an optional `_stack` constant, which can be used in a `CON` block. It is a one-time settable constant to specify the required stack space of an application. Read more about it in the Spin Language Reference section of the Propeller Manual.

Method Calls and the Result Variable

Every public and private method has a built-in, predefined local variable named `result`. Each time a given method is called, its `result` variable is initialized to zero. Then, the value of `result` can be defined by the code within the method. When that method is done executing, the current value of

result is returned. At that point, that method call can be used like a value (being the value of **result**) in expressions. When a method call appears in an expression, the method is executed to obtain its **result** value before the expression is evaluated.



About Method Calls in Expressions: A method call can be used in expressions in all the same ways a value can, including conditions, comparisons and normal operators. However, this excludes using it in an operation that attempts to change it. Therefore, a method call cannot be used with unary assignment operators, or as the “target” operand on the left side of a binary assignment operator.

One handy use of this feature allows us to take a value defined by processes in one method and make it available for use by other methods. Our example `ButtonBlink.spin` uses three methods to demonstrate: `Main`, `Blink`, and `ButtonTime`. In this application, pressing and then releasing a pushbutton on P23 will cause an LED on P4 to blink 10 times (using the `Blink` method), and the blink rate is determined by how long the pushbutton was held down (using the `ButtonTime` method).

Figure 5-6: Using a Method’s Result Variable

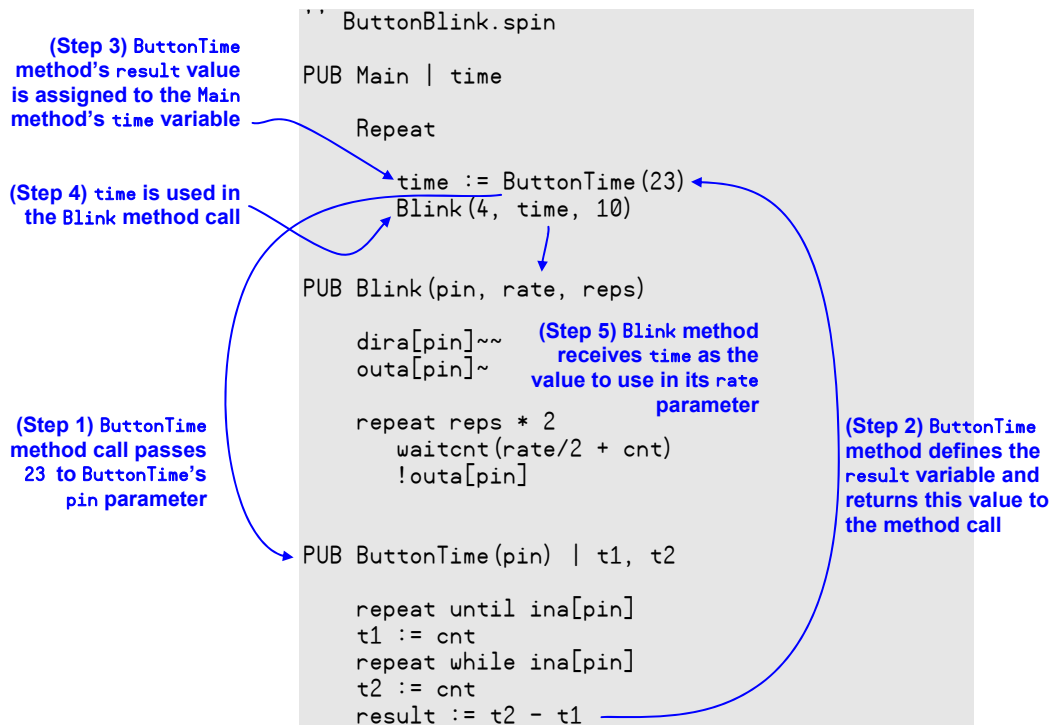

Take a look at Figure 5-6. `ButtonBlink`'s `Main` method declares just one variable, `time`. It contains just two method calls in a `repeat` loop. In the first one, `ButtonTime(23)` calls the `ButtonTime` method and passes the value 23 to its `pin` parameter (Step 1). The code in `ButtonTime` defines the value of its **result** variable, which represents how long the P23 pushbutton was held down. This value is returned to the point of the method call (Step 2). The expression `time := ButtonTime(23)` assigns the value returned by the `ButtonTime` method call to the `Main` method's `time` variable. (Step 3). Then, `time` is ready to be used in the next method call `Blink(4, time, 10)` (Step 4), as the value to pass to the `Blink` method's `rate` parameter (Step 5).

- ✓ Load `ButtonBlinkTime` into the Propeller chip.
- ✓ Press and release the LED, and observe that the LED blinks ten times at a rate determined by how long you held the button down.

Methods and Cogs Lab

- ✓ After the LED finishes blinking, press and hold the pushbutton down for a different amount of time to set a different blink rate.
- ✓ Try various durations from a quick tap on the pushbutton to holding it down for a few seconds.

Specifying Return Values

Public and private method declarations offer the option to name a return value (*Rvalue* in the **PUB** and **PRI** syntax definitions in the Propeller Manual). When a return value is specified, it actually just provides an alias to the method's **result** variable. This alias name is useful, especially for making the code self-documenting, but it is not required.

Below is a modified version of the `ButtonTime` method that demonstrates how a return value can be used instead of the **result** variable. Here, `:dt` has been added to the method declaration, and the last line now reads `dt := t2 - t1` instead of `result := t2 - t1`. Keep in mind that `dt` is really just an alias to the **result** local variable. So, from the method call's standpoint, this revised method still functions identically to the one in the original `ButtonBlink` object.

```
PUB ButtonTime(pin) : dt | t1, t2    ' Optional return value alias specified

    repeat until ina[pin]
    t1 := cnt
    repeat while ina[pin]
    t2 := cnt
    dt := t2 - t1                    ' Value stored by dt is automatically returned
```

- ✓ Make a copy of the `ButtonBlink` object under a new tab.
- ✓ Substitute this modified version of the `ButtonTime` method into the copy of the `ButtonBlink` object and verify that it works the same way.
- ✓ Use the Summary and Documentation views to compare the two objects.

In the modified version of `ButtonBlink`, you should see the return value `dt` included in the Summary and Documentation views. Making a habit of defining return values when declaring methods that will be called inside expressions will make your objects easier to understand and reuse.

Cog ID Indexing

As mentioned earlier, objects can't necessarily predict which cog a given method will get launched into. The `cognew` command returns the ID of the cog it launched a method into. Each time a method gets launched into a new cog, the cog ID returned by the `cognew` command can be stored in a variable. This makes it possible to keep track of what each cog is doing.

The `CogStartStopWithButton` object demonstrates keeping track of cog IDs with an array variable in an application that launches a new cog each time the pushbutton is pressed and released. It uses the same `ButtonTime` method from the previous example object to measure the time the pushbutton was held down. Then, it launches the `Blink` method into a new cog with the `time` measurement determining the blink rate. The result is an application where each time you press and release the pushbutton, another LED starts blinking at a rate that matches the time you held down the pushbutton. After the sixth pushbutton press/release, the next six pushbutton press/releases will shut down the cogs in reverse sequence. Since the entire cog-starting-and-stopping is nested into a **repeat** loop with no conditions, the 13th time you press/release the P23 pushbutton will have the same effect as the first press/release.

- ✓ Load `CogStartStopWithButton.spin` into the Propeller chip, and use the P23 pushbutton to successively launch the `Blink` method into six other cogs.
- ✓ Try a variety of button press times so that each LED is obviously blinking at a different rate.
- ✓ Make sure to press/release the P23 pushbutton at least twelve times to launch and then shut down Cogs 1 through 7.

```
'' File: CogStartStopWithButton.spin
'' Launches methods into cogs and stops the cogs within loop structures that
'' are advanced by pushbuttons.

VAR

    long stack[60]

PUB ButtonBlinkTime | time, index, cog[6]

    repeat

        repeat index from 0 to 5
            time := ButtonTime(23)
            cog[index] := cognew(Blink(index + 4, time, 1_000_000), @stack[index * 10])

        repeat index from 5 to 0
            ButtonTime(23)
            cogstop(cog[index])

PUB Blink( pin, rate, reps)

    dira[pin]~~
    outa[pin]~

    repeat reps * 2
        waitcnt(rate/2 + cnt)
        !outa[pin]

PUB ButtonTime(pin) : delta | time1, time2

    repeat until ina[pin] == 1
        time1 := cnt
    repeat until ina[pin] == 0
        time2 := cnt
    delta := time2 - time1
```

Inside ButtonBlinkTime

The `CogStartStopWithButton` object's `ButtonBlinkTime` method is declared with eight local variables: `time`, `index`, and an array named `cog` with six elements. The `repeat` command under the method declaration repeats the rest of the commands in the method since they are all indented further. Because this `repeat` command has no conditions, the rest of the commands in the method get repeated indefinitely.

```
PUB ButtonBlinkTime | time, index, cog[6]

    repeat
```

The first nested `repeat` loop increments the `index` variable from 0 to 5 each time through. The first command it repeats is `time := ButtonTime(23)`, which gets a new button-press elapse time measurement each instance it's called. Next, the line `cog[index] := cognew...` launches

Methods and Cogs Lab

Blink(index + 4, time, 1_000_000) into a new cog. The `cognew` command returns the cog ID, which gets stored in `cog[index]`. The first time through the loop, `index` is equal to 0, so the command becomes `cog[0] := cognew(Blink(4, time, 1_000_000), @stack[0])`. The second time through, it's `cog[1] := cognew(Blink(5, time, 1_000_000), @stack[10])`. The third time through, it's `cog[2] := cognew(Blink(6, time, 1_000_000), @stack[20])`, and so on. So, `cog[0]`, `cog[1]`, up through `cog[5]`, each stores the cog ID for a different cog in which a different version of `Blink` was launched.

```
repeat index from 0 to 5
  time := ButtonTime(23)
  cog[index] := cognew(Blink(index + 4, time, 1_000_000), @stack[index * 10])
```

After the sixth button press/release, the code enters this `repeat` loop. Notice how the `ButtonTime` method gets called, but its return value doesn't get stored in the `time` variable. That's because this method is just being used to wait for the next pushbutton press/release so that it can shut down the next cog. Since nothing is done with its return value, it doesn't need to be stored by the `time` variable. This `repeat` loop goes from 5 to 0. So the first time through, `cogstop` will shut down the cog with the ID stored in `cog[5]`. The second time through, it will shut down the cog with the ID stored in `cog[4]`, and so on, down to `cog[0]`.

```
repeat index from 5 to 0
  ButtonTime(23)
  cogstop(cog[index])
```

Study Time

Questions

- 1) What happens if a method that was called runs out of commands?
- 2) How many parameters can be passed to a method?
- 3) How many values does a method return?
- 4) How do you determine what value a method returns?
- 5) What two arguments does `cognew` need to launch a method into a new cog?
- 6) What's the difference between Cog 0's stack and other cogs' stacks?
- 7) What's the difference between `cognew` and `coginit`?
- 8) How to you stop a cog?
- 9) When a method gets called, what items get copied to the cog's stack?
- 10) What can happen to the stack as the commands in a method are executed?
- 11) What happens to a stack during nested method calls?
- 12) What's the best way to avoid trouble with stacks when you are prototyping a method that gets launched into a cog?
- 13) What feature of the `cognew` command makes it possible for the program to keep track of which process is occurring in which cog?
- 14) Is it possible to launch successive cogs in a loop?

Exercises

- 1) Write a public declaration for a method named `SquareWave` that expects parameters named `pin`, `tHigh`, and `tCycle`, returns `success`, and has the local variables `tC` and `tH`.
- 2) Write a call to the method from Question #1. Set the `pin` to 24, the high time to 1/2000th of the system clock frequency, and the cycle time 1/100ths of the clock frequency. Store the result in a variable named `yesNo`.
- 3) Set aside 40 longs named `swStack` for prototyping the `SquareWave` method in a separate cog.

- 4) Declare a variable named `swCog` for storing the cog ID of the cog the `SquareWave` method gets launched into.
- 5) Launch the `SquareWave` method into a new cog and store the cog ID in the `swCog` variable with the start address of the `swStack` variable.
- 6) Launch the `SquareWave` method into Cog 5.
- 7) Modify the `swStack` variable declaration for launching three copies of the `SquareWave` methods into separate cogs. Remember, this is for prototyping, and the unneeded stack space will be reclaimed later (in the Objects lab).
- 8) Modify the `swCog` variable declaration for storing three different cog IDs.
- 9) Launch three copies of the `SquareWave` method into separate cogs. Here is a list of parameters for each `SquareWave` method: (1) 5, `clkfreq/20`, `clkfreq/10`, (2) 6, `clkfreq/100`, `clkfreq/5`, (3) 9, `clkfreq/1000`, `clkfreq/2000`.

Projects

- 1) Prototype the `SquareWave` method described in the Exercises section. Make sure to incorporate the coding techniques to prevent inaccuracies due to command execution time that were introduced in the I/O and Timing lab. (Please keep in mind that there are higher-performance ways to generate square waves that will be introduced in the Counters and Assembly Language labs.)
- 2) Write a program to test the `SquareWave` method using various features from the Exercises section.
- 3) More experimentation: You may have noticed that the P9 LED glowed dimly. If you decrease the `tHigh` term by increasing the denominator, it will get dimmer. If you increase the `tHigh` term by decreasing its denominator, it will get brighter. Make sure that `tHigh` is always smaller than `tCycle`, otherwise the program will not work as intended. Try it.

6: Objects Lab

Introduction

In the previous labs, all the application code examples were individual objects. However, applications are typically organized as collections of objects. Every application has a *top object*, which is the object where the code execution starts. Top objects can declare and call methods in one or more other objects. Those objects might in turn declare and call methods in other objects, and so on...

A lot of objects that get incorporated into applications are designed to simplify development. Some of these objects are collections of useful methods that have been published so that common coding tasks don't have to be done "from scratch." Other objects manage processes that get launched into cogs. They usually cover the tasks introduced in the Methods and Cogs lab, including declaring stack space and tracking which cog the process gets launched into. These objects that manage cogs also have methods for starting and stopping the processes.

Useful objects that can be incorporated into your application are available from a number of sources, including the Propeller Tool software's Propeller Library, the Propeller Object Exchange at obex.parallax.com, and the Propeller Chip forum at forums.parallax.com. Each object typically has documentation that explains how to incorporate it into your application along with one or more example top files that demonstrate how to declare the object and call its methods. In addition to using pre-written objects, you may find yourself wanting to modify an existing object to suit your application's needs, or even write a custom object. If you write an object that solves problems or performs tasks that are not yet available elsewhere, consider posting it to the Propeller Object Exchange.

This lab guides you through writing a variety of objects and incorporating them into your applications. Some of the objects are just collections of useful methods, while others manage processes that get launched into cogs. Some of the objects will be written from scratch, and others from the Propeller Library will be used as resources. The example applications will guide you through how to:

- Call methods in other objects
- Use objects that launch processes into cogs
- Write code that calls an object's methods based on its documentation
- Write object documentation and schematics
- Use objects from the Propeller Object library
- Access values and variables by their memory addresses
- Use objects to launch cogs that read and/or update the parent object's variables.

Prerequisite Labs

- Setup and Testing
- I/O and Timing
- Methods and Cogs

Equipment, Parts, Schematic

Although the circuit is the same one used in the previous two labs, there are a few twists. First, the schematic shown in Figure 6-1 was drawn using the Parallax font and the Propeller Tool software's Character Chart, which is an important component of documenting objects. Second, some of the coding examples allow you to monitor and control elements of the circuit from your PC with software bundled with this lab called Parallax Serial Terminal (PST.exe). The Propeller applications that communicate serially with Parallax Serial Terminal will do so with the help of an object named FullDuplexSerial.spin.

- ✓ You can access the character chart by clicking *Help* and then selecting *View Character Chart*.

Figure 6-1: Schematic (drawn with the Propeller Tool software)

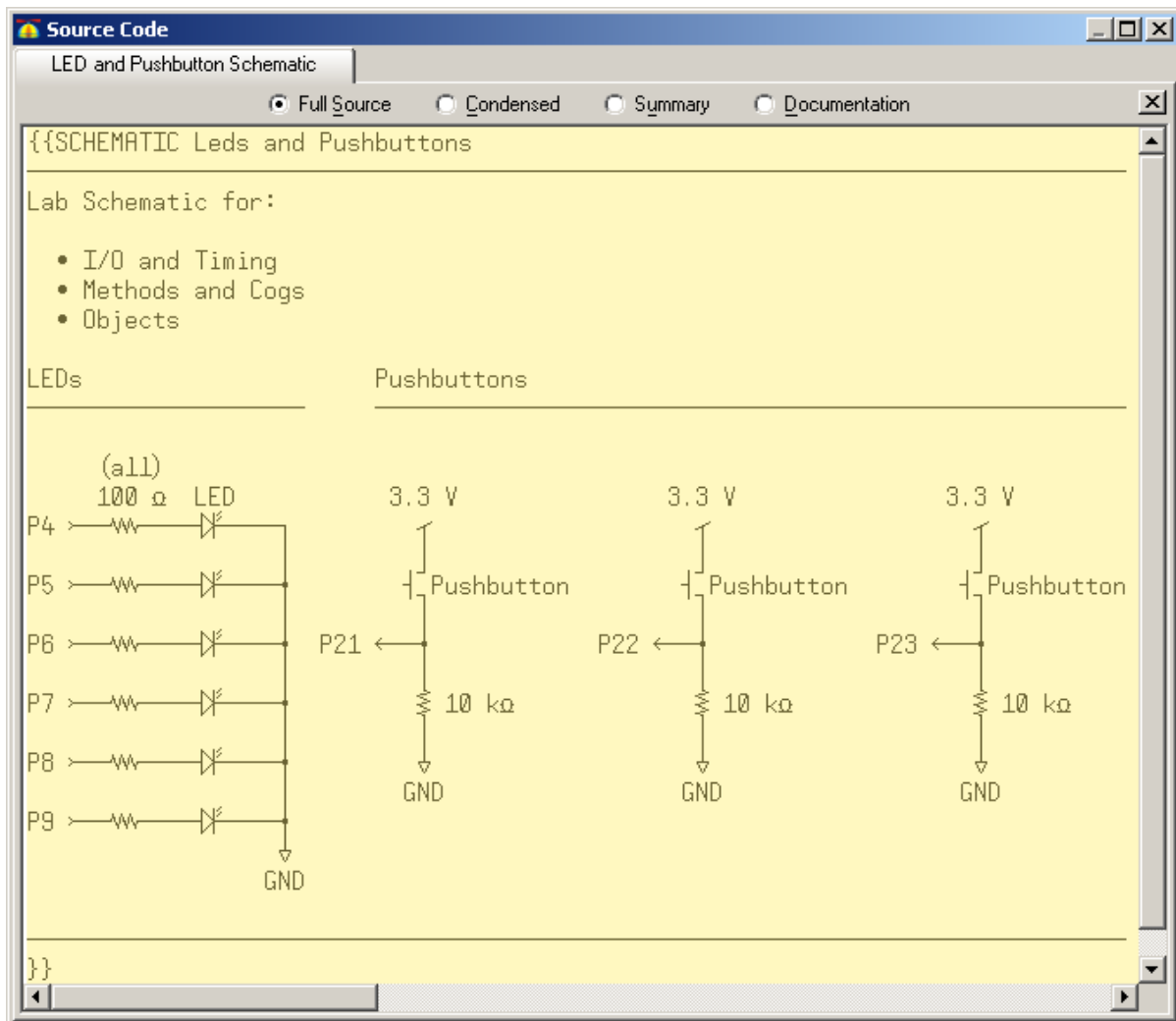

Method Call Review

The ButtonBlink object below is an example from the Methods and Cogs lab. Every time you press and release the pushbutton connected to P23, the object measures the approximate time the button is held down, and uses it to determine the full blink on/off period, and blinks the LED ten times. (Button debouncing is not required with the pushbuttons included in the PE kit.) The object accomplishes these tasks by calling other methods in the same object. Code in the `Main` method calls the `ButtonTime` method to measure the time the button is held down. When `ButtonTime` returns a value, the `Blink` method gets called, with one of the parameters being the result of the `ButtonTime` measurement.

- ✓ Load `ButtonBlink.spin` into the Propeller chip and test to make sure you can use the P23 pushbutton to set the P4 LED blink period.

```

'' ButtonBlink.spin
PUB Main | time
  Repeat
    time := ButtonTime(23)
    Blink(4, time, 10)
PUB Blink(pin, rate, reps)
  dira[pin]~~
  outa[pin]~
  repeat reps * 2
    waitcnt(rate/2 + cnt)
    !outa[pin]
PUB ButtonTime(pin) : dt | t1, t2
  repeat until ina[pin]
  t1 := cnt
  repeat while ina[pin]
  t2 := cnt
  dt := t2 - t1

```

Calling Methods in Other Objects with Dot Notation

The ButtonBlink object's `ButtonTime` and `Blink` methods provide a simple example of code that might be useful in a number of different applications. These methods can be stored in a separate object file, and then any object that needs to blink an LED or measure a pushbutton press can access these methods by following two steps:

- 1) Declare the object in an `OBJ` code block, and give the object's filename a nickname.
- 2) Use `ObjectName.MethodName` to call the object's method.



What we are calling "dot notation" here is referred to as "object-method reference" in the Propeller Manual.

Objects Lab

Figure 6-2 shows an example of how this works. The `ButtonTime` and `Blink` methods have been moved to an object named `ButtonAndBlink`. To get access to the `ButtonAndBlink` object's public methods, the `DotNotationExample` object has to start by declaring the `ButtonAndBlink` object and giving it a nickname. These object declarations are done in the `DotNotationExample` object's `OBJ` code block. The declaration `PbLed : "ButtonAndBlink"` gives the nickname `PbLed` to the `ButtonAndBlink` object.

The `PbLed` declaration makes it possible for the `DotNotationExample` object to call methods in the `ButtonAndBlink` object using the notation `ObjectName.MethodName`. So, `DotNotationExample` uses `time := PbLed.ButtonTime(23)` to call `ButtonAndBlink`'s `ButtonTime` method, pass it the parameter 23, and assign the returned result to the `time` variable. `DotNotationExample` also uses the command `PbLed.Blink(4, time, 20)` to pass 4, the value stored in the `time` variable, and 20 to `ButtonAndBlink`'s `Blink` method.



File Locations: An object has to either be in the same folder with the object that's declaring it, or in the same folder with the Propeller Tool.exe file. Objects stored with the Propeller Tool are commonly referred to as library objects.

Figure 6-2: Calling Methods in Another Object with Dot Notation

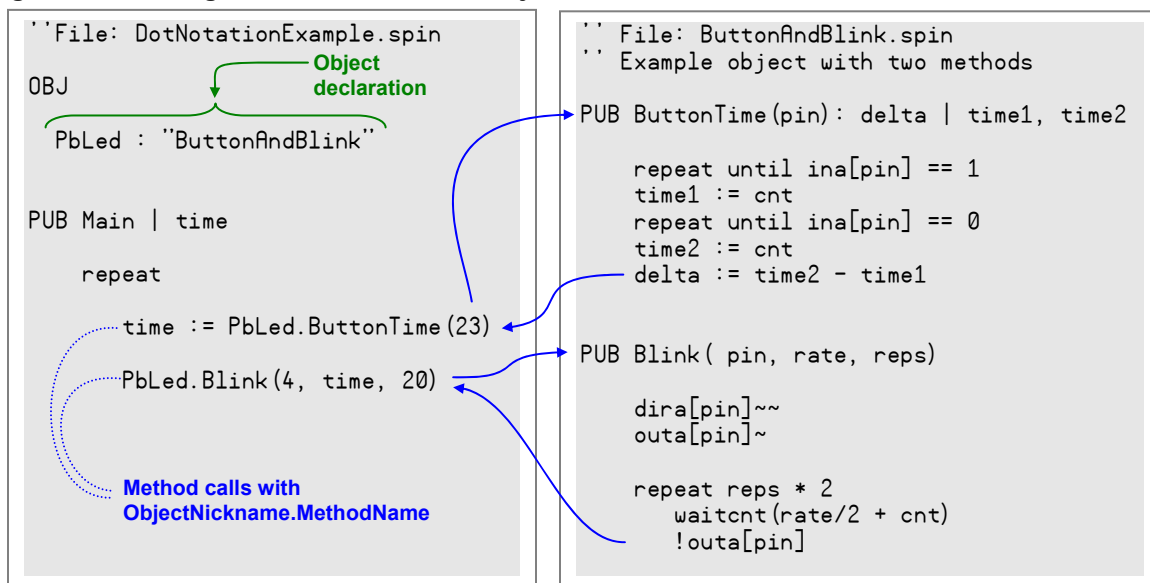

- ✓ Load the `DotNotationExample` object into the Propeller chip. If you are hand entering this code, make sure to save both files in the same folder. Also, the `ButtonAndBlink` object's filename must be `ButtonAndBlink.spin`.
- ✓ Verify that the program does the same job as the previous example object (`ButtonBlink`).
- ✓ Follow the steps in Figure 5-4, and make sure it's clear how `ButtonAndBlink` gets a nickname in the `OBJ` section, and how that nickname is then used by `DotNotationExample` to call methods within the `ButtonAndBlink` object.
- ✓ Compare `DotNotationExample.spin` to the previous example object (`ButtonBlink`).

Object Organization

Objects can declare objects that can in turn declare other objects. It's important to be able to examine the interrelationships among parent objects, their children, grandchildren, and so on. There are a couple of ways to examine these object family trees. First, let's try viewing the relationships in the Object Info window with the Propeller Tool's Compile Current feature:

- ✓ Click the Propeller Tool's Run menu, and select Compile Current → View Info (F8).

Notice that the object hierarchy is shown in the Object Info window's top-left corner. In this windowpane, you can single click each folder to see how much memory it occupies in the Propeller chip's global RAM. You can also double-click each folder in the Object Info window to open the Spin file that contains the object code. Since DotNotationExample declared ButtonAndBlink, the ButtonAndBlink code becomes part of the DotNotationExample application, which is why it appears to have more code than ButtonAndBlink in the Object Info window even though it has much less actual typed code.

Figure 6-3: Object Info Window

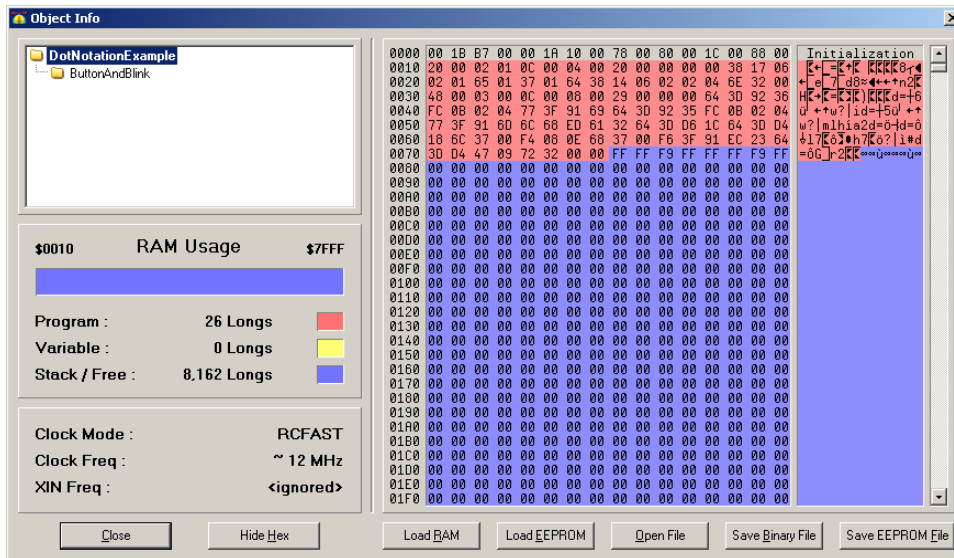

After closing the Object Info window, the same Object View pane will be visible in the upper-left corner of the Propeller tool (see Figure 6-4). The objects in this pane can be opened with a single-click. The file folder icons can also be right-clicked to view a given object in documentation mode. They can then be left-clicked to return to Full Source view mode.

Figure 6-4: Propeller Tool with Object View (Upper-Left Windowpane)

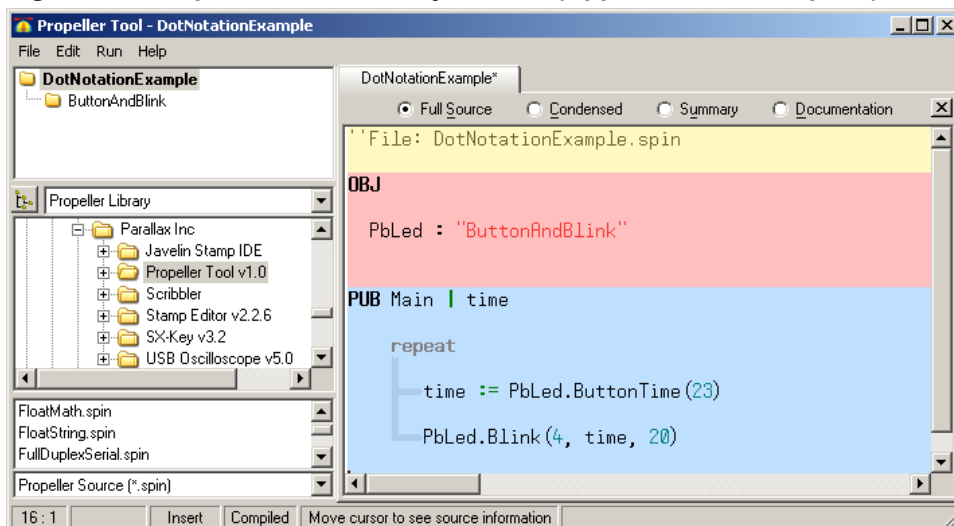

Objects that Launch Processes into Cogs

In the Methods Lab, it took several steps to write a program that launches a method into a cog. First, additional variables had to be declared to give the cog stack space and track which cog is running which process before the `cognew` or `cogstart` commands could be used. Also, a variable that stored the cog's ID was needed to pick the right cog if the program needed to stop a given process after starting it. Objects that launch processes into cogs can take care of all these details for you. For example, here is a top object file that declares two child objects, named `Button` and `Blinker`. The `Blinker` object has a method named `Start` that takes care of launching its `Blink` method into a new cog and all the variable bookkeeping that accompanies it. So, all this top object has to do is call the `Blinker` object's `Start` method.

```
{{
Top File: CogObjectExample.spin
Blinks an LED circuit for 20 repetitions. The LED
blink period is determined by how long the P23 pushbutton
is pressed and held.
}}

OBJ

  Blinker : "Blinker"
  Button  : "Button"

PUB ButtonBlinkTime | time

  repeat

    time := Button.Time(23)
    Blinker.Start(4, time, 20)
```

Unlike the `DotNotationExample` object, you won't have to wait for 20 LED blinks before pressing the button again to change the blink rate (for the next 20 blinks). There are two reasons why. First, the `Blinker` object automatically launches the LED blinking process into a new cog. This leaves Cog 0 free to monitor the pushbutton for the next press/release while Cog 1 blinks the LED. Second, the `Blinker` object's `Start` method automatically stops any process it's currently running before launching the new process. So, as soon as the button measurement gets taken with `Button.Time(23)`, the `Blinker.Start` method stops any process (cog) that it might already be running before it launches the new process.

- ✓ If you are using the pre-written .spin files that are available for this text (see page 17), they will already all be in the same folder. If you are hand entering code, make sure to hand enter and save all three objects in the same folder. The objects that will have to be saved are `CogObjectExample` (above), `Blinker`, and `Button` (both below).
- ✓ Load `CogObjectExample` into the Propeller chip.
- ✓ Try pressing and releasing the P23 pushbutton so that it makes the LED blink slowly.
- ✓ Before the 20th blink, press and release the P23 pushbutton rapidly. The LED should immediately start blinking at the faster rate.

Inside the Blinker Object

Building block objects that launch processes into cogs are typically written to take care of most cog record-keeping details. All a parent object has to do is declare the object, and then launch the process by calling the object's `Start` method, or halt it by calling the object's `Stop` method. For example, the `Blinker` object below has the necessary variable array for the cog's stack operations while executing

the `Blink` method in another cog. It also has a variable named `cog` for keeping track of which cog it launched its `Blink` method into.

The `Blinker` object has the `Start` and `Stop` methods for launching the now-familiar `Blink` method into a new cog and stopping it again. When the `Start` method launches the `Blink` method into a new cog, it takes the cog ID that `cognew` returns, adds 1 to it, and copies the resulting value into the `cog` variable. The value the `Start` method returns in the `success` variable is also `cog ID + 1`, which the parent object can treat as a Boolean value. So long as this value is non-zero, it means the process launched successfully. If the value is zero, it means the cog was not successfully launched. This typically happens when all eight of the Propeller chip's cogs are already in use. The `Blinker.spin` object's `Stop` method can be called to shut down the process. When it gets called, it uses the value stored in the `cog` variable (minus 1) to get the right cog ID for shutting down the cog that the `Start` method launched the `Blink` method into.

```

{{ File: Blinker.spin
Example cog manager for a blinking LED process.

SCHEMATIC

```

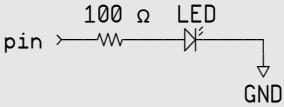

```

}}
VAR
  long  stack[10]           'Cog stack space
  byte  cog                'Cog ID

PUB Start(pin, rate, reps) : success
  {{Start new blinking process in new cog; return True if successful.
Parameters:
  pin - the I/O connected to the LED circuit → see schematic
  rate - On/off cycle time is defined by the number of clock ticks
  reps - the number of on/off cycles
  }}
  Stop
  success := (cog := cognew(Blink(pin, rate, reps), @stack) + 1)

PUB Stop
  ''Stop blinking process, if any.

  if cog
    cogstop(cog~ - 1)

PUB Blink(pin, rate, reps)
  {{Blink an LED circuit connected to pin at a given rate for reps repetitions.
Parameters:
  pin - the I/O connected to the LED circuit → see schematic
  rate - On/off cycle time is defined by the number of clock ticks
  reps - the number of on/off cycles
  }}
  dira[pin]~~
  outa[pin]~

  repeat reps * 2
    waitcnt(rate/2 + cnt)
    !outa[pin]

```

Objects Lab

The `Start` and `Stop` methods shown in this object are the recommended approach for objects that manage cogs. The `Start` method's parameter list should have all the parameters the process will need to get launched into a cog. Note that these values are passed to the object's `Blink` method via a call in the `cognew` command.

`Start` and `Stop` methods are used by convention in objects that launch processes into new cogs. If you are using an object with `Start` and `Stop` methods, you can expect the object's `Start` method to launch the process into a new cog for you, and the `Stop` method will halt the process and free up that cog. If you are writing code that depends on building block objects with `Start` and `Stop` methods, your main concern will be calling the `Start` method from a parent object and passing it the correct parameters. These parameters are typically explained by an object's documentation comments, which will be introduced in the Documentation Comments section starting on page 90.

`Start` and `Stop` methods also keep track of which cog the process (the `Blink` method in the case of `Blinker.spin`) gets launched into. If all the cogs are already in use, the `Start` method returns 0; otherwise, it returns cog ID + 1, which is nonzero. This simplifies the parent object's job of checking to find out if the `Start` method successfully launched the process into a new cog. Especially if the parent object has already called lots of other objects' `Start` methods, all the Propeller chip's cogs might be working on other tasks at some point. For example, the parent object can check to find out if the `Blinker` object's `Start` method succeeded like this:

```
if Blinker.Start
    'Insert code for successful Start here
else
    'Insert code for fail to Start here
```

The code under and indented from the `if` statement executes if `Blinker.Start` indicates that it successfully launched the cog by returning nonzero. If the `Blinker.Start` method instead returned zero, this indicates that it was unable to launch the cog, which can happen if all the cogs are already busy. In that case, the code under and indented from the `else` condition would execute.

A common practice among authors of building block objects is to copy and paste example `Start` and `Stop` methods from the Propeller Manual or this text into their objects they write. They then adjust the `Start` method's parameter list and documentation as needed. Not only do the example `Start` and `Stop` methods conform to Conventions for `Start` and `Stop` Methods in Library Objects discussed on page 90, they combine correct cog bookkeeping with returning nonzero/zero values to indicate success. If you are interested in exactly how they do this, pay careful attention to the next section. Otherwise, skip to The Button Object section, which starts on page 89.

Advanced Topic: Inside Start and Stop methods

In addition to the stack array a `Spin` method needs when it gets launched into another cog, the `Blinker` object also declares a `cog` variable. This global variable is accessible to all the methods in the object, so the `Start` method can store a value that corresponds to which cog was launched in this variable, and the `Stop` method can access this variable if it needs to know which cog to stop.

```
VAR
    long stack[10]           'Cog stack space
    byte cog                 'Cog ID
```

The `cognew` command in the `Start` method returns the cog ID. The value of the cog ID could be 0 to 7, if it successfully launches a cog, or -1 if it failed to launch a cog. Since -1 is nonzero, the `Start` and `Stop` methods have to do a little extra bookkeeping to keep track of which cog is running the

```
PUB Time(pin) : delta | time1, time2
```

```
repeat until ina[pin] == 1
time1 := cnt
repeat until ina[pin] == 0
time2 := cnt
delta := time2 - time1
```

Conventions for Start and Stop Methods in Library Objects

If an object that is designed to be a building block for other objects launches a cog, it should have `Start` and `Stop` methods. The `Start` method takes care of launching the cog. If it's launching a spin method into a new cog, the `Start` method uses the `cognew` command to pass the method call and the address of the object's global variable stack array to the cog. It also records which cog the method was launched into with one of the object's global variables, typically a byte variable named `cog`. The `Stop` method finds out which cog it needs to shut down by checking that same `cog` variable.

The convention of `Start` and `Stop` methods in building block objects that launch cogs was established by Parallax keep the user interfaces simple and consistent. It also provides the object designer with a place to take care of the stack space and cog number record keeping for the object. If you use an object from the Propeller Library folder or from the Propeller Object exchange, and if it launches a cog, it should have `Start` and `Stop` methods that take care of all these details. Then, all your application object has to do is call the object's `Start` method and pass it the parameters it needs. The library object takes care of everything else, and it should also provide methods and documentation comments that simplify monitoring and controlling the process happening in the cog it launched.



Never use `cognew` or `coginit` to launch a method that's in another object. The `cognew` and `coginit` commands can only successfully launch a Spin method into a new cog if it's in the same object with the command. This is another reason why building block objects that launch cogs should always have start and stop methods. The `cognew` command is located in the object's start method, ensuring that it's in the same object with the method it's going to launch into another cog.

Many useful objects don't need to launch a cog. When the parent object calls its methods, they just do something useful in the same cog. In some cases, these objects have variables that need to be configured before the object can provide its services. The recommended method name for configuring object variables if it doesn't launch a cog is either `Init` or `Config`. Don't use the method name `start` in these kind of objects because it could mislead people into thinking it launches a cog. Likewise, don't use `start` as a method name at the beginning of your application code. Instead, use the method name `Go` if nothing more descriptive comes to mind.

Documentation Comments

Figure 6-5 shows the first part of the Blinker object displayed in documentation view mode. To view the object in this mode, make sure it's the active tab (click the tab with the Blinker filename), then click the Documentation radio button just above the code. Remember from the I/O and Timing Lab that single line documentation comments are preceded by two apostrophes: `''comment`, and that documentation comments occupying more than one line are started and ended with double braces: `{{comments}}`. Take a look at the documentation comments in Full Source mode, and compare them to the comments in Documentation mode.

Documentation view mode automatically adds some information above and beyond what's in the documentation comments. First, there's the Object Interface information, which is a list of the object's public method declarations including the method name, parameter list, and return value

name, if any. This gives the programmer an “at a glance” view of the object’s methods. With this in mind, it’s important to choose descriptive names for an object’s method, and the method’s parameters and return value. Documentation mode also lists how much memory the object's use would add to a program and how much it takes in the way of variables. These, of course, are also important “at a glance” features.

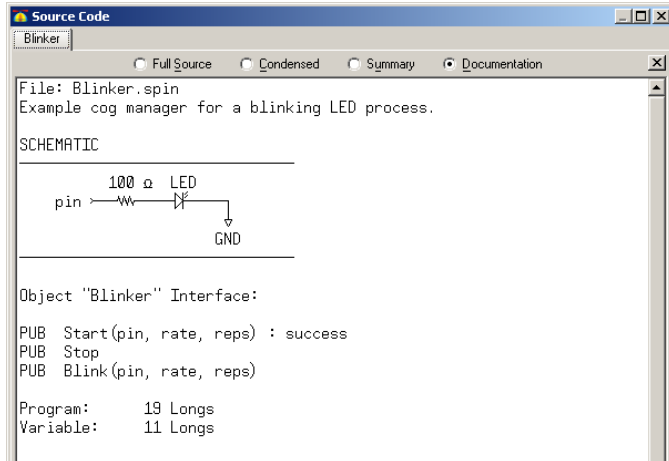

Figure 6-5: Documentation View

The Documentation view mode also inserts each method declaration (without local variables that are not used as parameters or return variable aliases). Notice how documentation comments below the method declaration also appear, and how they explain what the method does, what information its parameters should receive, and what it returns. Each public method’s documentation should have enough information for a programmer to use it without switching back to Full Source view to reverse engineer the method and try to figure out what it does. This is another good reason to pick your method and parameter names carefully, because they will help make your documentation comments more concise. Below each public method declaration, explain what the method does with documentation comments. Then, explain each parameter, starting with its name and include any necessary information about the values the parameter has to receive. Do the same thing for the return value as well.

- ✓ Try adding a block documentation comment just below the CogObjectExample object’s ButtonBlinkTime method, and verify that the documentation appears below the method declaration in Documentation view mode.

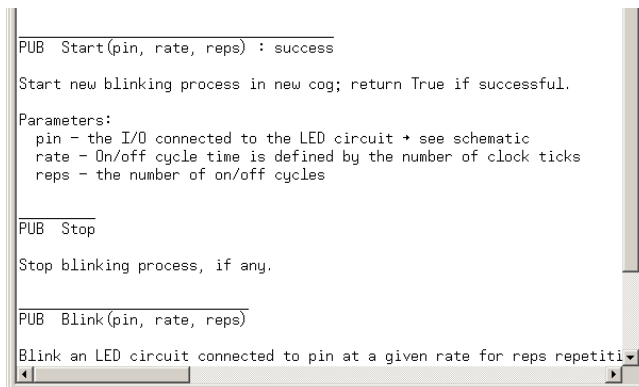



Figure 6-6: More Documentation View

Drawing Schematics

The Parallax font has symbols built in for drawing schematics, and they should be used to document the circuits that objects are designed for. The Character Chart tool for inserting these characters into an object is shown in Figure 6-7. In addition to the symbols for drawing schematics, it has symbols for timing diagrams , math operators \pm $+$ $-$ \times \div $=$ \approx $\sqrt{\quad}$ $^{-1}$ 1 2 3 , and Greek symbols for quantities and measurements Ω μ Δ Σ π .

- ✓ Click *Help* and select *View Character Chart*.
- ✓ Click the character chart's symbolic *Order* button
- ✓ Place your cursor in a commented area of an object.
- ✓ Click various characters in the Character Chart, and verify that they appear in the object.

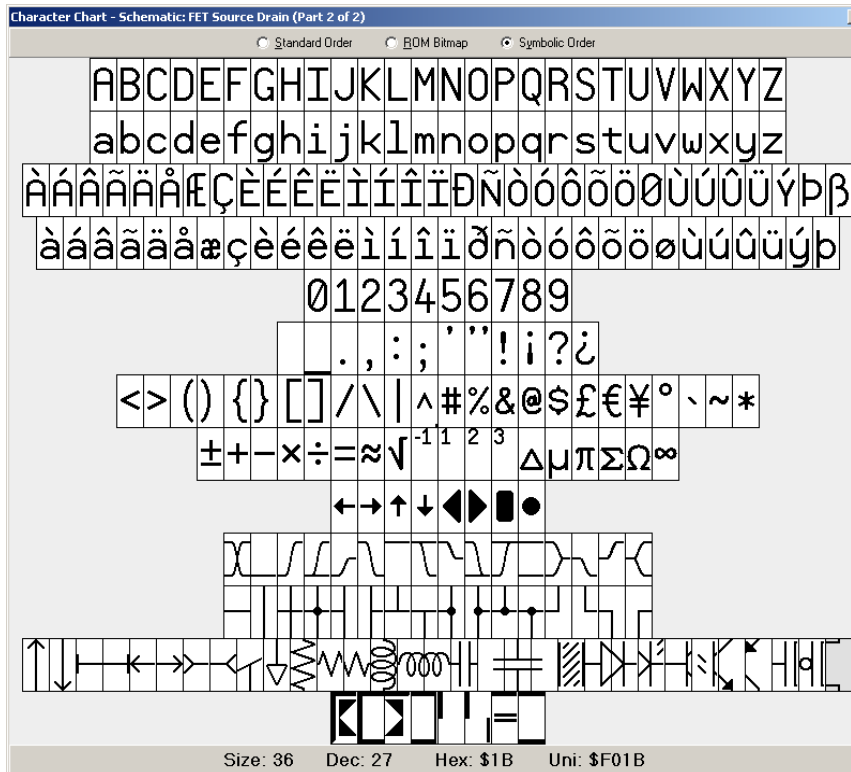

Figure 6-7: Propeller Tool Character Chart

Files that involve circuits should also have schematics so that the circuit the code is written for can be built and tested. For example, the schematic shown in Figure 6-8 can be added to CogObjectExample. The pushbutton can be a little tricky. The character chart is shown in Figure 6-8, displayed in the standard order (click the Standard Order radio button). In this order, character 0 is the top left, character 1, the next one over from top-left, and so on, all the way down to character 255 on the bottom-right. Here is a list of characters you will need:

Pushbutton: 19, 23, 24, 27, 144, 145, 152, 186, 188
 LED: 19, 24, 36, 144, 145, 158, 166, 168, 169, 189, 190

- ✓ Try adding the schematic shown in Figure 6-8 to your copy of CogObjectExample.

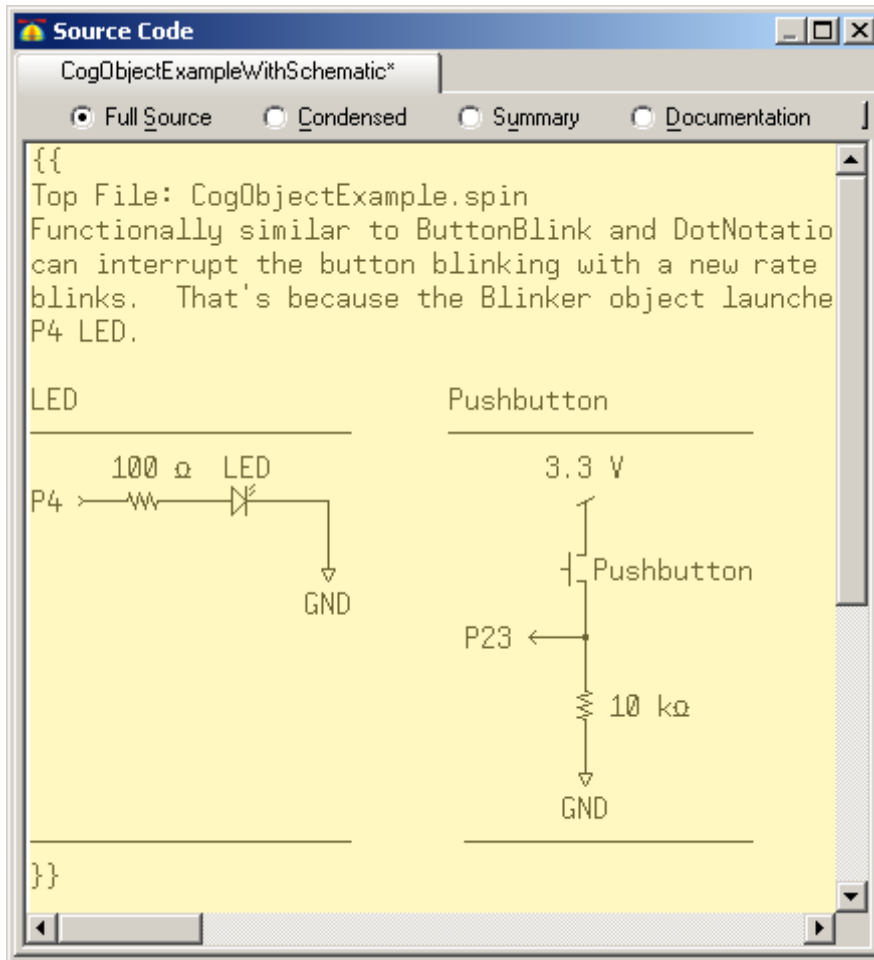

Figure 6-8: Drawing Schematics with the Character Chart

Public vs. Private methods

The Blinker object is currently written so that its parent object can call either its `Start` or `Blink` methods. For this particular object, it's useful because there are times when the programmer might not want to allow the 20 LED blinks to be interrupted. In that case, instead of calling the `Start` method, the parent object can call the `Blink` method directly.

- ✓ Modify a copy of `CogObjectExample` so that it calls the Blinker object's `Blink` method instead of its `Start` method.

The modified version will not let you interrupt the LED blinking to restart at a different rate. That's because all the code now gets executed in the same cog; whereas the unmodified version allows you to call the `Start` method at any time since the LED blinking happens in a separate cog. So, while the cog is busy blinking the LED it does not monitor the pushbutton.

Some objects are written so that they have public (**PUB**) methods that other objects can call, and private (**PRI**) methods, which can only be called from another method in the same object. Private methods tend to be ones that help the object do its job, but are not intended to be called by other objects. For example, sometimes an intricate task is separated into several methods. A public method might receive parameters and then call the private methods in a certain sequence. Especially if calling those methods in the wrong sequence could lead to undesirable results, those other methods should be private.

With the Blinker object's `Blink` method, there's no actual reason to make it private aside from examining what happens when a parent object tries to call another object's private method.

- ✓ Change the Blinker object's `Blink` method from `PUB` to `PRI`.
- ✓ Try to run the modified copy of `CogObjectExample`, and observe the error message. This demonstrates that the `Blink` method cannot now be accessed by another object since it's private.
- ✓ Run the unmodified copy (which only calls the public `Start` method, not the now private `Blink` method), and verify that it still works properly. This demonstrates how the now private `Blink` method can still be accessed from within the same (Blinker) object by its `Start` method.

Multiple Object Instances

Spin objects that launch and manage one or more cogs for a given process are typically written for just one copy of the process. If the application needs more than one copy of the process running concurrently, the application can simply declare more than one copy of the object. For example, the Propeller chip can control a television display with one cog, but each TV object only controls one television display. If the application needs to control more than one television, it declares more than one copy of the TV object.



Multiple object copies? No Problem!

There is no code space penalty for declaring multiple instances of an object. The Propeller Tool's compiler optimizes so that only one instance of the code is executed by all the copies of the object. The only penalty for declaring more than one copy of the same object is that there will be more than one copy of the global variables the object declares, one set for each object. Since roughly the same number of extra variables would be required for a given application to do the same job without objects, it's not really a penalty.

The `MultiCogObjectExample` object below demonstrates how multiple copies of an object that manages a process can be launched with an object array. Like variables, objects can be declared as arrays. In this example, six copies of the Blinker object are declared in the `OBJ` block with `Blinker[6] : Blinker`. The six copies of Blinker can also be indexed the same way variable arrays are, with `Blinker[0]`, `Blinker[1]`, and so on, up through `Blinker[5]`. In `MultiCogObjectExample`, a **repeat** loop increments an index variable, so that `Blinker[index].Start...` calls each successive object's `Start` method.

The `MultiCogObjectExample` object is functionally equivalent to the Methods and Cogs lab's `CogStartStopWithButton` object. When the program is run, each successive press/release of the P23 pushbutton launches new cogs that blink successive LEDs (connected to P4 through P9) at rates determined by the duration of each button press. The first through sixth button presses launch new LED blinking processes into new cogs, and the seventh through twelfth presses successively stop each LED blinking cog in reverse order.

- ✓ Load the `MultiCogObjectExample.spin` object into the Propeller chip.
- ✓ Press and hold the P23 pushbutton six successive times (each with a different duration) and verify that six cogs were launched.
- ✓ Press and release the P23 pushbutton six more times and verify that each LED blinking process halts in reverse order.

```
''Top File: MultiCogObjectExample.spin
OBJ
  Blinker[6] : "Blinker"
  Button     : "Button"

PUB ButtonBlinkTime | time, index
  repeat
    repeat index from 0 to 5
      time := Button.Time(23)
      Blinker[index].Start(index + 4, time, 1_000_000)

    repeat index from 5 to 0
      Button.Time(23)
      Blinker[index].Stop
```

Propeller Chip – PC Terminal Communication

Exchanging characters and values with the Propeller microcontroller using PC terminal software makes a number of applications really convenient. Some examples include computer monitored and controlled circuits, datalogging sensor measurements, and sending and receiving diagnostic information for system testing and debugging.

Terminal/Propeller chip communication involves PC software and microcontroller code. For the PC software, we'll use the Parallax Serial Terminal, which is introduced next. For the microcontroller code, we'll make use of objects that take care of the electrical signaling and conversions between binary values and their character representations so that we can focus on writing applications.

As you develop applications that make use of the serial communication objects, consider how those readily available objects simplify writing programs. It provides an example of how using objects from the Propeller Library, Propeller Object Exchange, and Propeller Chip forum make it possible to get a lot done with just a few lines of code.

Parallax Serial Terminal

The Parallax Serial Terminal software (PST.exe) shown in Figure 6-9 is a convenient tool for PC/Propeller chip communication. It displays text and numeric messages from the Propeller chip and also allows you to send similar messages to the Propeller chip.

- ✓ If you have not already done so, go to Software, Documentation & Resources on page 17, and follow the instructions for downloading and setting up the Parallax Serial Terminal.

This software has a Transmit windowpane that sends characters you type to the Propeller chip, and a Receive windowpane that displays characters sent by the Propeller chip. It has drop-down menus for *Com Port* and *Baud Rate* selection and port activity indicators and checkbox controls for the various serial channels (*TX*, *RX*, etc). There's also an *Echo On* checkbox that is selected by default so that characters entered into the Transmit windowpane also appear in the Receive windowpane.

Objects Lab

On the Parallax Serial Terminal window's lower-right, there are control buttons that:

- Display and edit preferences (*Prefs*)
- (*Clear*) the terminal windows
- (*Pause*) the display of incoming data
- (*Disable/Enable*) the Parallax Serial Terminal's connection to the serial port

Figure 6-9: Parallax Serial Terminal

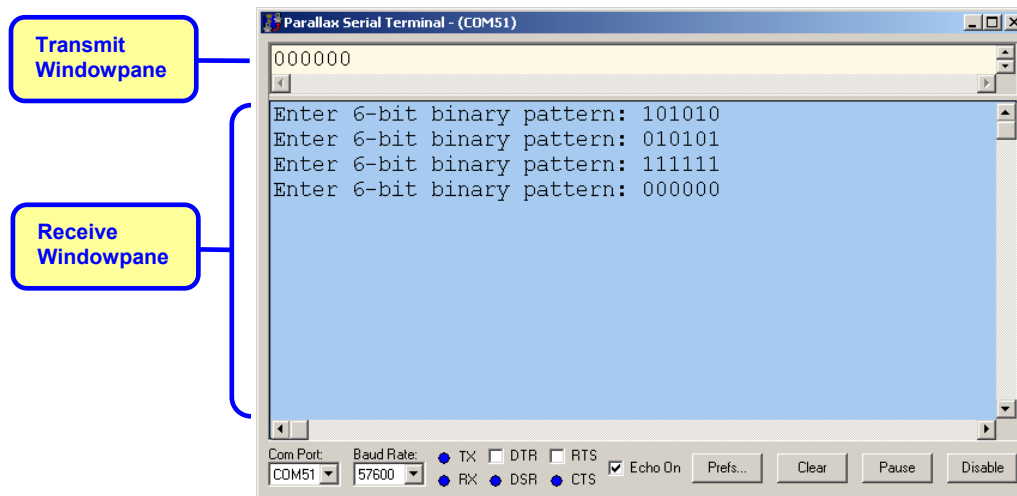

The *Disable/Enable* button in the Parallax Serial Terminal's lower-right corner is important. (See Figure 6-10.) When it displays *Disable*, it means the terminal is connected to the serial port. When you click the *Disable* button, the Parallax Serial Terminal releases the serial port so that the Propeller Tool can use it to load a program into the Propeller chip. While the Parallax Serial Terminal is disabled, the button displays *Enable*, flashing on/off. After the program has loaded, you can click the *Enable* button to resume terminal communication with the Propeller chip.

Automatic Disable/Enable Settings

In *Prefs* → *Serial Port Selection*, the *Automatically disable...* and *Wait for busy...* checkboxes are selected by default. With these settings, you can just click the Propeller Tool software, load a program, and immediately click the *Enable* button to reconnect. There's no need to click *Disable* before switching to the Propeller Tool to load a program because the Parallax Serial Terminal will automatically disconnect from the serial port as soon as you have clicked another window. Likewise, you don't have to wait for the program to finish loading into the Propeller chip before clicking the *Enable* button. You can just click it as soon as you have started the program loading, and the Parallax Serial Terminal will detect that the serial port is still busy and wait until the Propeller Tool is done loading the program before it reconnects.

Figure 6-10: Connected vs. Disconnected (to/from the Com Port)

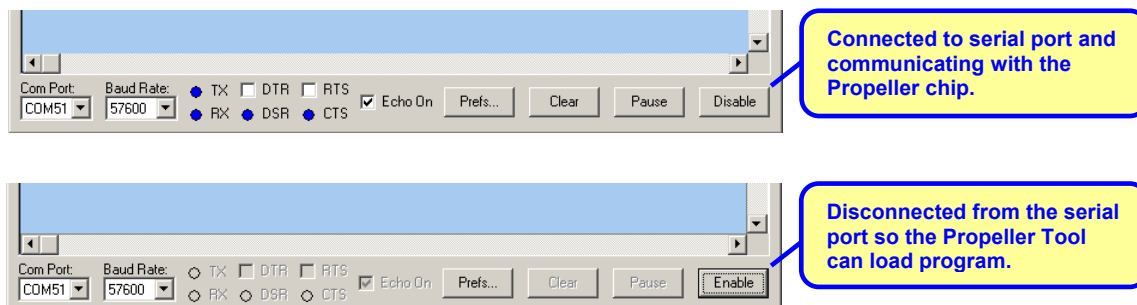

You can click the Parallax Serial Terminal's *Prefs* button to view the appearance and function preference tabs shown in Figure 6-11. The *Appearance* preferences allow you to define the terminal's colors, fonts, and other formatting. The *Function* preferences allow you to select special functions for non-printable ASCII characters. Leave all of them checked for these labs since we'll be using them to clear the screen, display carriage returns, etc...

Figure 6-11: Appearance and Function Preferences

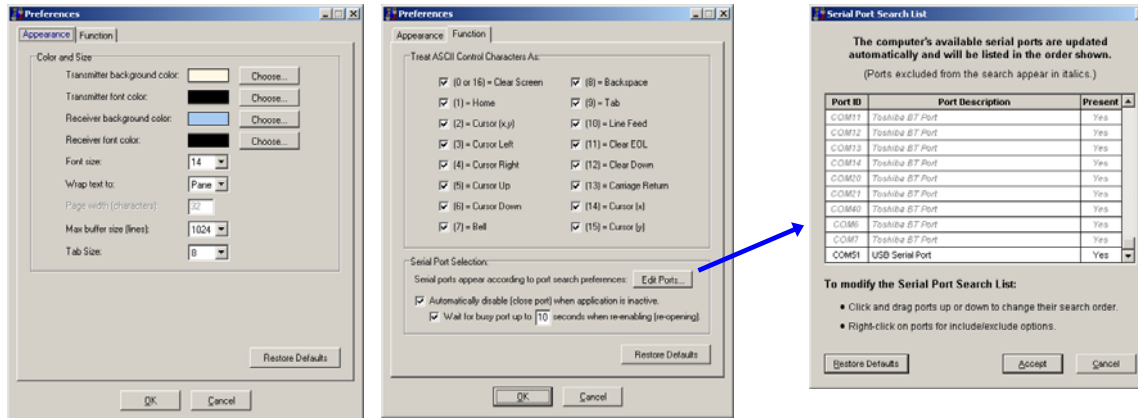

It's also best to leave both the boxes in the Serial Port Selection category checked. The *Automatically Disable...* feature makes the Parallax Serial Terminal automatically disable to free the serial port for program loading whenever you click the Propeller Tool software. *Wait for busy port...* makes the Parallax Serial Terminal automatically wait up to 10 seconds if you click the *Enable* button before the Propeller tool is finished loading the program. (Not an issue with *Load RAM* (F10), but *Load EEPROM* (F11) can take a few seconds.) If those features were unchecked, you would have to manually click *Disable* before loading a program and wait until the program is finished loading before clicking *Enable* to reconnect.

When to uncheck the *Automatically disable...* setting:

The *Automatically disable...* setting is very convenient for iteratively modifying code with the Propeller Tool software and observing the results in the Parallax Serial Terminal. The event that triggers the automatic *Disable* is the fact that you clicked another window.

Let's say you are instead switching back and forth between the Parallax Serial Terminal and some other software such as a spreadsheet for sensor measurement analysis. With the *Automatically disable...* setting, each time you click the other window, the Parallax Serial Terminal automatically disconnects from the serial port, and any messages sent by the Propeller chip will not be buffered or displayed.

To make the Parallax Serial Terminal maintain the serial port connection while you are working with other windows, uncheck the *Automatically disable...* setting. Then, the Parallax Serial Terminal will remain connected to the serial port and continue displaying updated messages, regardless of which window you are working in. Keep in mind that with this setting unchecked, you will have to manually click the *Disable* button before loading a program and then click the *Enable* button after the program is done loading.

The Edit Ports button in Figure 6-11 opens the Serial Port Search List. You can drag entries in the list up and down to change the order they appear in the Parallax Serial Terminal's *Com Port* drop-down menu. You can also right-click an entry to include or exclude it, or even create rules for which ports get included or excluded based on text in the Port Description column.

Parallax Serial Terminal Test Messages

Figure 6-12 shows the HelloFullDuplexSerial application on the left, and the repeated messages it sends to the Parallax Serial Terminal on the right. The HelloFullDuplexSerial program declares the FullDuplexSerial object and then uses its methods to send messages to the Parallax Serial Terminal. It first calls the FullDuplexSerial object's start method with Debug.start, and then repeatedly calls the str (string) method with Debug.str in a repeat loop. Let's first give it a try, and then take a closer look at the FullDuplexSerial object and its features and methods.

Figure 6-12: Using the FullDuplexSerial object to Display Messages in Parallax Serial Terminal

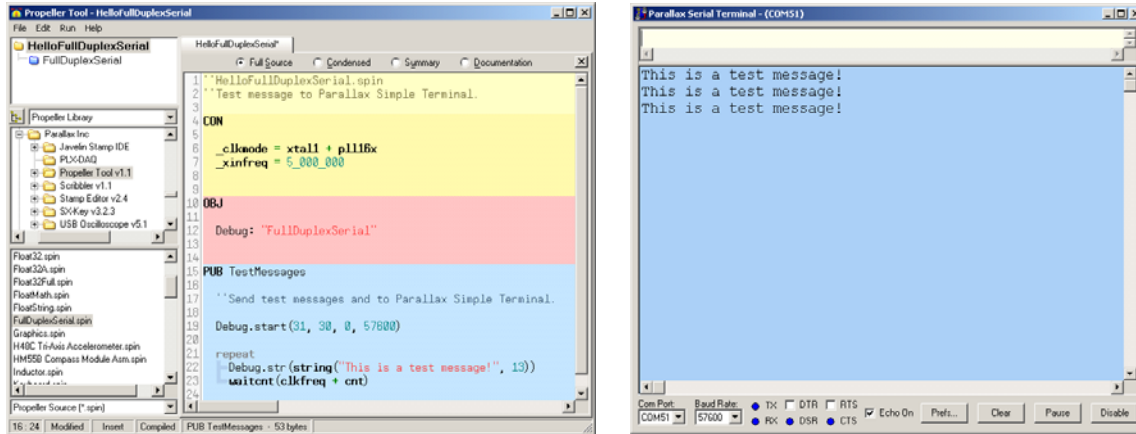

The first time you open the Parallax Serial Terminal (PST.exe), you'll need to set the *Com Port* to the one the Propeller Tool software uses to load programs into the Propeller chip. You'll also need to set the *Baud Rate* to the one used by the Spin program. After that, just use the Propeller Tool software's Load EEPROM feature to load the program into the Propeller chip's EEPROM, and then click the Parallax Serial Terminal's *Enable* button to see the messages.

- ✓ Open HelloFullDuplexSerial.spin with the Propeller Tool software.
- ✓ Open the Parallax Serial Terminal (double-click PST.exe to run it.)
- ✓ Connect battery power to your PE Platform and verify that it is connected to the PC with the USB cable.
- ✓ In the Propeller Tool software, click *Run*, and select *Identify Hardware...* (F7). Make a note of the COM port where the Propeller chip was found.
- ✓ Set the *Com Port* field in the bottom-left corner of the Parallax Serial Terminal to the Propeller's COM port you found in the previous step.
- ✓ Check the *baudrate* parameter in the Debug.start method call to find the baud rate. (It's currently 57600.)
- ✓ Set the *Baud Rate* field in the Parallax Serial Terminal to match. (Set it to 57600.)
- ✓ In the Propeller Tool software, use F11 to load HelloFullDuplexSerial.spin into the Propeller chip's EEPROM.
- ✓ In the Parallax Serial Terminal, click the *Enable* button to start displaying messages from the Propeller chip.

```

''HelloFullDuplexSerial.spin
''Test message to Parallax Serial Terminal.

CON

  _clkmode = xtall + pll16x
  _xinfreq = 5_000_000

OBJ

  Debug: "FullDuplexSerial"

PUB TestMessages

  ''Send test messages to Parallax Serial Terminal.

  Debug.start(31, 30, 0, 57600)

  repeat
    Debug.str(string("This is a test message!", 13))
    waitcnt(clkfreq + cnt)

```

IMPORTANT NOTE FOR WHEN YOUR PROPELLER CHIP IS NOT CONNECTED TO THE PC!

If your Propeller chip is running an application but not connected to the PC, code that tries to send messages to the PC can cause the Propeller chip to be reset by the USB to serial converter.

The USB to serial converter normally gets its power from the USB port. If the USB-to-serial converter is disconnected from the USB port, its FTDI USB-to-serial converter chip should be shut down. However, if the Propeller tries to send messages to the PC, the signal voltages can supply enough power for the FTDI chip to wake up briefly. When it wakes up, one of the first things it does is toggle the DTR line, which in turn resets the Propeller chip.

The solution for the 40-pin DIP version of the PE Kit is simple. Just unplug the Propeller Plug from the 4-pin header to remove the USB-to-serial converter from the system. This prevents any messages intended for a PC to inadvertently cause the FTDI chip to reset the Propeller chip.

Since the PropStick USB module has its FTDI USB-to-serial converter built-in, it needs a different remedy. Before running an application that's not connected to the PC with the USB cable, make sure to comment out or remove all code that attempts to send messages to the PC. This will prevent the application from mysteriously resetting when the PE platform is not connected to a PC.

Changing Baud Rates

So long as the Baud rates are the same, you can select the baud rate that's best for your application. For example, you can change the baud rate from 57.6 to 115.2 kbps as follows:

- ✓ In the Propeller Tool, modify the HelloFullDuplexSerial object's `start` method call, so that it passes the value 115200 to the FullDuplexSerial object's `start` method's `baudrate` parameter, like this:

```
Debug.start(31, 30, 0, 115200)
```

- ✓ Load the modified version of HelloFullDuplexSerial into the Propeller chip.
- ✓ Choose 115200 in the Parallax Serial Terminal's *Baud Rate* drop-down menu.
- ✓ Click Parallax Serial Terminal's *Enable* Button.
- ✓ Verify that the messages still display at the new baud rate.
- ✓ Make sure to change the settings back to 57600 in both programs and test to make sure they still work before proceeding.

FullDuplexSerial and Other Library Objects

The FullDuplexSerial object greatly simplifies exchanging data between the Propeller and peripheral devices that communicate with asynchronous serial protocols such as RS232. Just a few examples of serial devices that can be connected to the Propeller chip include the PC, other microcontrollers, phone modems, the Parallax Serial LCD, and the Pink Ethernet module.



Serial Communication: For more information about asynchronous serial communication, see the *Serial Communication* and *RS232* articles on Wikipedia.

Serial-over-USB: For more information about how the FT232 chip built into the Propeller Plug and the PropStick USB relays serial data to the PC over the USB connection, see the PropStick USB version of the Setup and Testing lab.

As mentioned earlier, code in an object can declare another object, so long as either:

- The two objects are in the same folder
- The object being declared is in the same folder with the Propeller Tool software

The objects in the same folder with the Propeller Tool software are called Propeller Library objects. To view the contents of the Propeller Library:

- ✓ Click the drop-down menu between the upper-left and middle-left Explorer windowpanes shown in Figure 6-13 and select *Propeller Library*. The Propeller Library's objects will appear in the lower-left windowpane.

Notice in Figure 6-13 that the folder icon next to FullDuplexSerial in the Propeller Tool's upper left Object View windowpane is blue instead of yellow. This indicates that it's a file that resides in the Propeller Library. You can also see these files by using Windows Explorer to look in the Propeller Tool software's folder. Assuming a default install, the path would be: C:\Program Files\Parallax Inc\Propeller Tool v1.2.

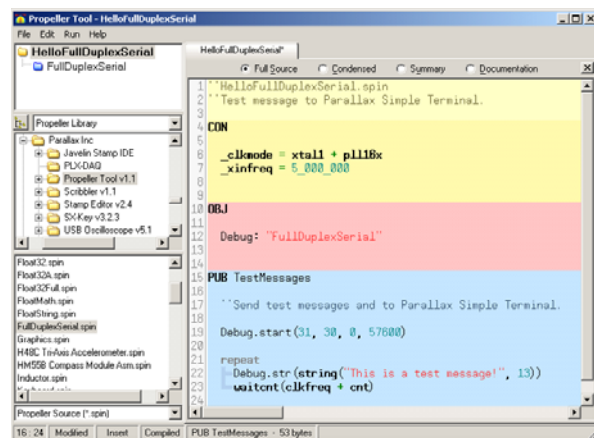

Figure 6-13: Code That Declares a Library Object

When using a library object, the first task is to examine its object interface to find out about its methods and what it can do.

- ✓ Double-click FullDuplexSerial in the Propeller Tool's lower left explorer pane, which should show the contents of the Propeller Library.
- ✓ When the Propeller Tool opens the FullDuplexSerial object, click the Documentation radio button so that the view resembles Figure 6-14.

- ✓ Check the list of methods in the Object “FullDuplexSerial” Interface section.
- ✓ Scroll down and find the documentation for the `start` and `str` methods, and examine them. They will be used in the next example object.

Figure 6-14: FullDuplexSerial Object Documentation Views

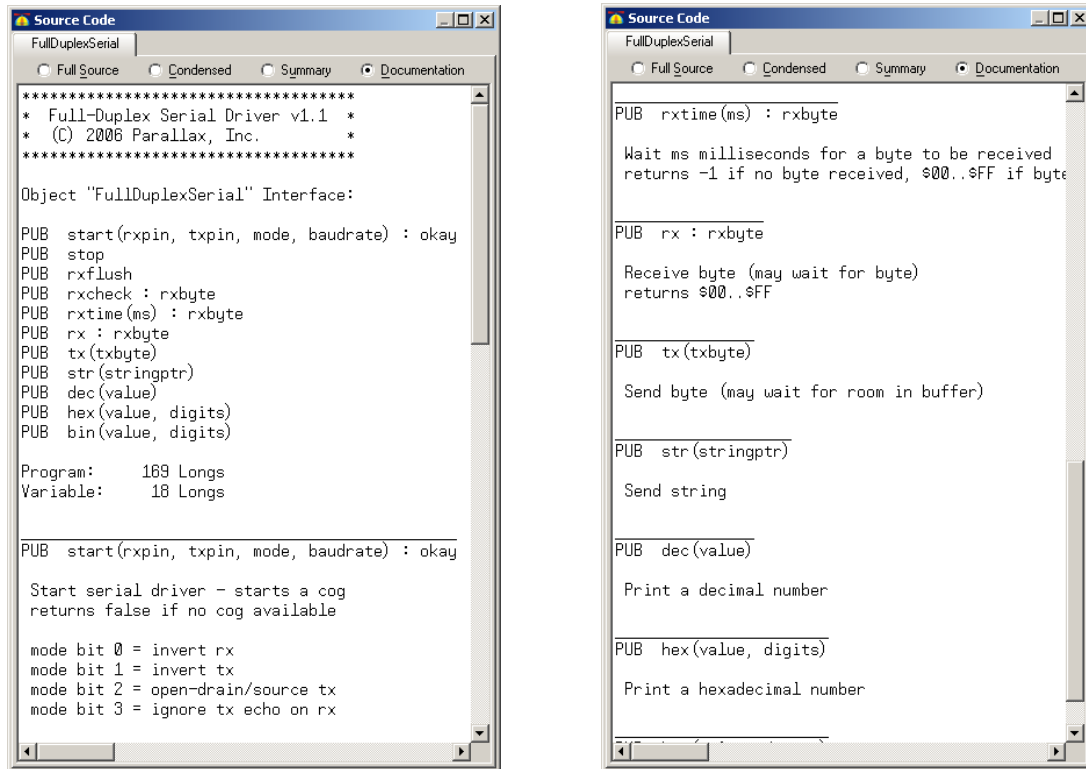

The `HelloFullDuplexSerial` object in Figure 6-13 declares the `FullDuplexSerial` object, giving it the nickname `Debug`. Then, it calls the `FullDuplexSerial` object’s `start` method with the command `Debug.start(31, 30, 0, 57600)`. According to the documentation, this sets the parameter’s `rxpin` to Propeller I/O pin 31, `txpin` to 30, `mode` to 0, and `baudrate` to 57600. After that, a **repeat** loop sends the same text message to the Parallax Serial Terminal once every second. The `Debug.str` method call is what transfers the “This is a test message!” string to the `FullDuplexSerial` object’s buffer. After that, `FullDuplexSerial` takes care of sending each successive character in the string to the FT232 chip which forwards it to the PC via USB.

Let’s take a closer look at `Debug.str(string("This is a test message!", 13))`. First, `Debug.str` calls the `FullDuplexSerial` object’s `str` method. The method declaration for the `str` method indicates that the parameter it expects to receive should be a string pointer. At compile, the `string` directive `string("This is a test message!")` stores the values that correspond to the characters in the text message in the Propeller chip’s program memory and appends them with a zero to make a zero-terminated string. Although the `str` method’s documentation doesn’t say so (It really should!), it expects a zero-terminated string so that it can fetch and transmit characters until it fetches a zero. At runtime, the `string` directive returns the starting address of the string. `Debug.str` passes this parameter to the `FullDuplexSerial` object’s `str` method. Then, the `str` method sends characters until it fetches the zero terminator.



What does the 13 do? The 13 in `Debug.str(String("This is a test message!", 13))` is a control character that makes the Parallax Serial Terminal display a carriage return. That's why each "This is a test message!" appears on its own line, because the previous message was followed by a carriage return. See Figure 6-11 for the Parallax Serial Terminal's list of control characters.

You can see where the string gets stored in the program with the Propeller Tool Software's Object Info window.

- ✓ While viewing the `HelloFullDuplexSerial` object with the Propeller Tool, click *Run*, then point at *Compile Current*, and select *View info (F8)*. The Object Info window shown in Figure 6-15 should appear.
- ✓ Look for the text in the rightmost column's, 3rd and 4th lines. The hexadecimal ASCII codes occupy memory addresses 0038 through 004F with the 0 terminator at address 50.

Figure 6-15: Finding a Text String in Memory

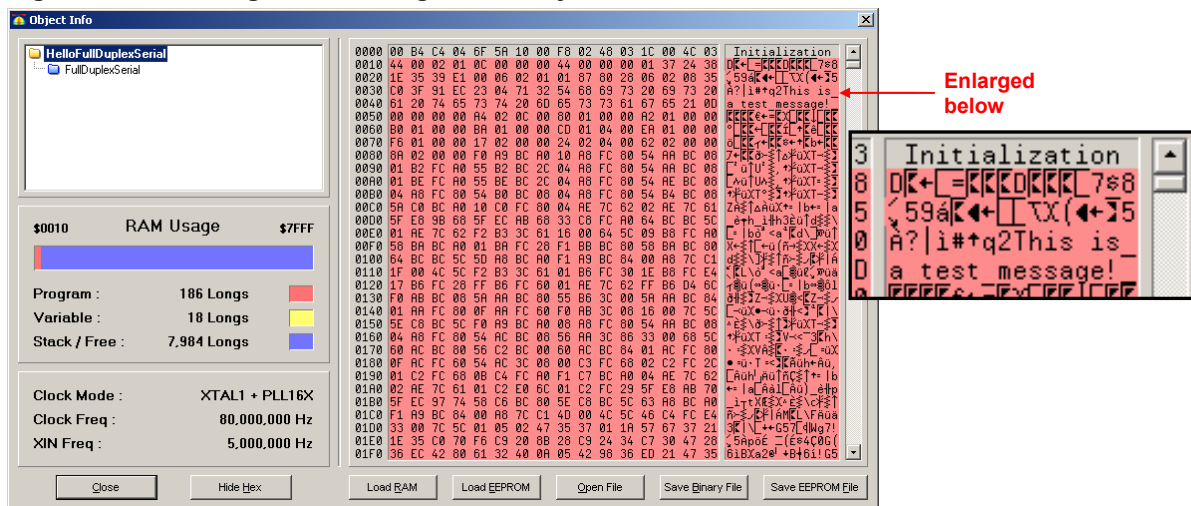

Displaying Values

Take another look at the `FullDuplexSerial` object in documentation mode. (See Figure 6-14 on page 101.) Notice that it also has a `dec` method for displaying decimal numbers. This method takes a value and converts it to the characters that represent the value before transmitting them serially to the Parallax Serial Terminal. It's especially useful for displaying sensor readings and values stored by variables for figuring out program bugs.

- ✓ Modify the `HelloFullDuplexSerial` object's test messages declaration by adding a local variable declaration:

```
PUB TestMessages | counter
```

- ✓ Modify the `HelloFullDuplexSerial` object's `repeat` loop as shown here:

```
repeat
  Debug.str(String(13, "counter = "))
  Debug.dec(counter++)
  waitcnt(clkfreq/5 + cnt)
```

- ✓ Use the Propeller Tool software to load the modified version of `HelloFullDuplexSerial` into the Propeller chip's EEPROM (F11).

- ✓ Click Parallax Serial Terminal's Enable button, and verify that the updated value of `counter` is displayed several times each second. You can press and release the PE Platform's Reset button to start the count at 0 again.

Sending Values from Parallax Serial Terminal to the Propeller Chip

The `FullDuplexSerial` object does not have a corresponding `GetDec` method to complement `dec`. So, as written, you cannot use `FullDuplexSerial` to receive a value from Parallax Serial Terminal. A modified version of `FullDuplexSerial` named `FullDuplexSerialPlus` is included with the `.spin` files that accompany this lab. The `FullDuplexSerialPlus` object has all the same methods as `FullDuplexSerial`, plus a few more, like `GetDec`, `GetBin`, and `GetHex`. The additional methods can be used to receive the character representations of decimal, hexadecimal and binary numbers from Parallax Serial Terminal, convert them to their corresponding numeric values, and store them in variables. Since `FullDuplexSerialPlus` also has the same methods as `FullDuplexSerial`, calls like `Debug.start`, `Debug.str`, and `Debug.dec` still yield the same results.



FullDuplexSerialPlus is bundled with the PE Labs download (see page 17), and a full listing of the code is also provided in Appendix A: Object Code Listings on page 187.

Remember that an object can be declared so long as it's either in the same folder with the object that's referencing it, or in the same folder as the Propeller Tool software. In this case, the `FullDuplexSerialPlus` object is in the same folder with this lab's example objects. So, it can be declared in a parent object's `OBJ` block almost same way `FullDuplexSerial` was. The only difference is that the parent object has to use the slightly different filename. So, instead of using a `Debug : FullDuplexSerial` declaration, use `Debug : FullDuplexSerialPlus`.

- ✓ Open both the `FullDuplexSerial` and `FullDuplexSerialPlus` objects in Documentation mode.
- ✓ Use the Object Interface section to see which methods have been added - there are 6, and the method names are capitalized.
- ✓ Check the documentation for the new methods. The documentation comments for the other methods were expanded too; look them over as well.

Test Application – EnterAndDisplayValues.spin

The `EnterAndDisplayValues` object below waits for you to enter a value into Parallax Serial Terminal's Transmit windowpane. Then, it converts the characters that represent the value into a numeric equivalent and displays them in decimal, hexadecimal and binary format.

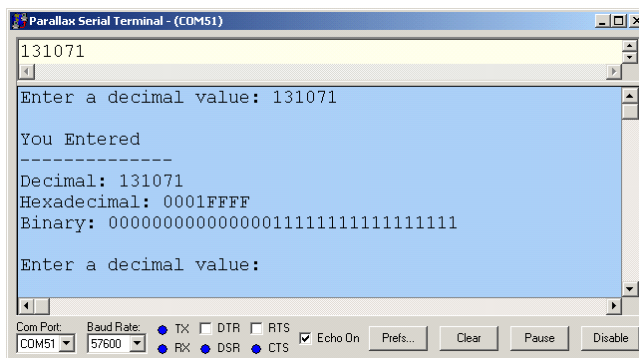

Figure 6-16: Testing for Input Values

Figure 6-16 shows an example of testing the `EnterAndDisplayValues` object with Parallax Serial Terminal. The object makes the Propeller chip send prompts that are displayed in Parallax Serial

Objects Lab

Terminal's Receive windowpane. After typing a decimal value into the Transmit windowpane and pressing enter, the Propeller chip converts the string of characters to its corresponding value, stores it in a variable, and then uses the FullDuplexSerialPlus object to send back the decimal, hexadecimal, and binary representations of the value.

- ✓ Use the Propeller Tool to load EnterAndDisplayValues.spin into EEPROM (F11) and immediately click the Parallax Serial Terminal's *Enable* button.
- ✓ The application gives you two seconds to connect to the Parallax Serial Terminal by clicking the *Enable* button. If no "Enter a decimal value:" prompt appears, you may not have clicked the *Enable* button in time. You can restart the application by pressing and releasing the PE Platform's reset button. You can also reset the Propeller chip from the terminal by checking and unchecking the DTR line.
- ✓ Follow the prompts in the Parallax Serial Terminal. Start with 131071 and verify that it displays the values shown in Figure 6-16.

The Propeller represents negative numbers with 32-bit twos complement. The Propeller chip's long variables store 32 bit signed integer values, ranging from -2,147,483,648 to 2,147,483,647.

- ✓ Enter these values: 4, 3, 2, 1, 0, -1, -2, -3, -4, -5, and discern the pattern of twos complement.
- ✓ Try entering 2,147,483,645, 2,147,483,646, and 2,147,483,647 and examine the equivalent hexadecimal and binary values.
- ✓ Also try it with -2,147,483,646, -2,147,483,647, and -2,147,483,648.

```
.. File: EnterAndDisplayValues.spin
.. Messages to/from Propeller chip with Parallax Serial Terminal. Prompts you to enter a
.. value, and displays the value in decimal, binary, and hexadecimal formats.

CON

  _clkmode = xtal1 + pll16x
  _xinfreq = 5_000_000

OBJ

  Debug: "FullDuplexSerialPlus"

PUB TwoWayCom | value

  ..Test Parallax Serial Terminal number entry and display.

  Debug.start(31, 30, 0, 57600)
  waitcnt(clkfreq*2 + cnt)
  Debug.tx(16)

  repeat

    Debug.Str(String("Enter a decimal value: "))
    value := Debug.getDec
    Debug.Str(String(13, "You Entered", 13, "-----"))
    Debug.Str(String(13, "Decimal: "))
    Debug.Dec(value)
    Debug.Str(String(13, "Hexadecimal: "))
    Debug.Hex(value, 8)
    Debug.Str(String(13, "Binary: "))
    Debug.Bin(value, 32)
    repeat 2
      Debug.Str(String(13))
```

Debug.dec vs. Debug.getDec

The FullDuplexSerialPlus object's GetDec method buffers characters it receives from Parallax Serial Terminal until the enter key is pressed. Then, it converts the characters into their corresponding decimal value, and returns that value. The EnterAndDisplayValues object's command `value := Debug.GetDec` copies the result of the GetDec method call to the `value` variable. The command `Debug.Dec(value)` displays the value in decimal format. The command `Debug.Hex(value, 8)` displays the value in 8-character hexadecimal format, and the command `Debug.Bin(value, 32)` displays it in 32-character binary format.

Hex and Bin Character Counts

If you're sure you're only going to be displaying positive word or byte size variables, there's no reason to display all 32 bits of a binary value. Since word variables have 16 bits, and byte variables only have 8 bits, there's no reason to display 32 bits when examining those smaller variables.

- ✓ Make a copy of EnterAndDisplayValues and change the command `Debug.Bin(value, 32)` to `Debug.Bin(value, 16)`.
- ✓ Remove the local variable `| value` from the TwoWayCom method declaration (remember that local variables are always 32 bits; global variables can be declared long, word, or byte.)
- ✓ Add a VAR block to the object, declaring `value` as a word variable.
- ✓ Re-run the program, entering values that range from 0 to 65535.
- ✓ What happens if you enter 65536, 65537, and 65538? Try repeating this with the unmodified object, to see the missing bits.

Each hexadecimal digit takes 4 bits. So, it will take 4 digits to display all possible values in a word variable (16 bits).

- ✓ Modify the copy of EnterAndDisplayValues so that it only displays 4 hexadecimal digits.

Terminal I/O Pin Input State Display

The Parallax Serial Terminal display provides a convenient means for testing sensors to make sure that both the program and wiring are correct. The DisplayPushbuttons object below displays the values stored in `ina[23..21]` in binary format as shown in Figure 6-17. A 1 in a particular slot indicates the pushbutton is pressed; a 0 indicates the pushbutton is not pressed. Figure 6-17 shows an example where the P23 and P21 pushbuttons are pressed.

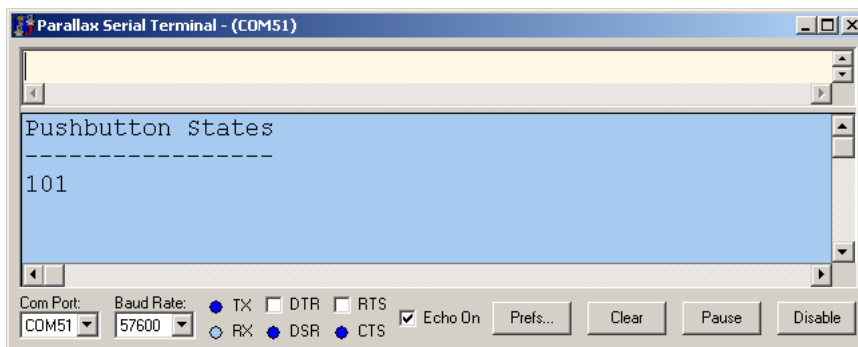

Figure 6-17: Serial Terminal Pushbutton State Display

The DisplayPushbuttons object uses the command `Debug.Bin(ina[23..21], 3)` to display the pushbutton states. Recall from the I/O and Timing lab that `ina[23..21]` returns the value stored in bits 23 through 21 of the `ina` register. This result gets passed as a parameter to the FullDuplexSerialPlus object's `bin` method with the command `Debug.bin(ina[23..21], 3)`. Note that

Objects Lab

since there are only 3 bits to display, the `bin` method's `bits` parameter is 3, which in turn makes the method display only 3 binary digits.

Since the `FullDuplexSerialPlus` object is running a serial driver in another cog, it is possible to transfer messages to it faster than the baud rate will allow it to send. The `waitcnt(clkfreq/100 + cnt)` command paces the updated values every 1/100 of a second to prevent buffer overflow.

- ✓ Use the Propeller Tool to load the `DisplayPushbuttons.spin` object into EEPROM (F11), and immediately click the Parallax Serial Terminal's *Enable* button. Again, if you don't click it within 2 seconds after the download, just press the PE Platform's reset button to restart the program.
- ✓ Press and hold various combinations of the P23..P21 pushbuttons and verify that the display updates when they are pressed.

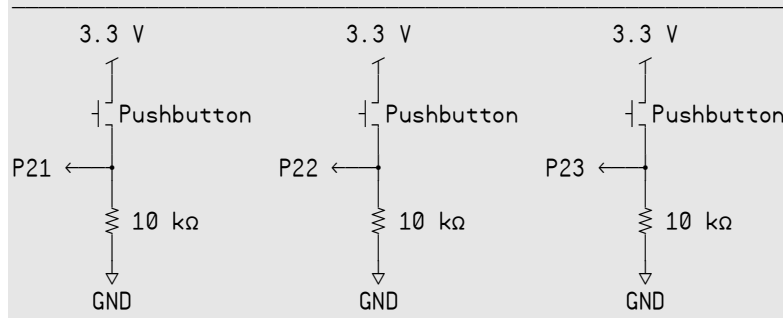
```
{  
DisplayPushbuttons.spin  
Display pushbutton states with Parallax Serial Terminal.  
  
Pushbuttons  
  
  
}}  
  
CON  
_clkmode = xtal1 + pll16x  
_xinfreq = 5_000_000  
  
OBJ  
Debug: "FullDuplexSerialPlus"  
  
PUB TerminalPushbuttonDisplay  
  
'' Read P23 through P21 pushbutton states and display with Parallax Serial Terminal.  
  
Debug.start(31, 30, 0, 57600)  
waitcnt(clkfreq*2 + cnt)  
Debug.tx(Debug#CLS)  
Debug.str(String("Pushbutton States", Debug#CR))  
Debug.str(String("-----", Debug#CR))  
  
repeat  
    Debug.tx(Debug#CRSRX)  
    Debug.tx(0)  
    Debug.Bin(ina[23..21], 3)  
    waitcnt(clkfreq/100 + cnt)
```

Accessing Constants in Objects with ObjectNickname#OBJECT_CONSTANT

You may have noticed that the expression `Debug#CR` replaced the number 13 for a carriage return. (See the left side of Figure 6-18.) That's because the constants for the Parallax Serial Terminal's control characters are declared in the `FullDuplexSerialPlus` object. You can see them in the `FullDuplexSerialPlus` object documentation on the right side of Figure 6-18. Instead of using the numbers or declaring them a second time in the top object, `DisplayPushbuttons` uses `ObjectNickname#OBJECT_CONSTANT` notation to specify control characters that get sent to Parallax Serial Terminal.

- ✓ Examine the `FullDuplexSerialPlus` object in both Full Source and Documentation mode.
- ✓ Make a note of how the constants are declared, and how they are documented with double-apostrophe `' '` comments.

Figure 6-18: DisplayPushbuttons Full Source (left), FullDuplexSerialPlus Documentation (right)

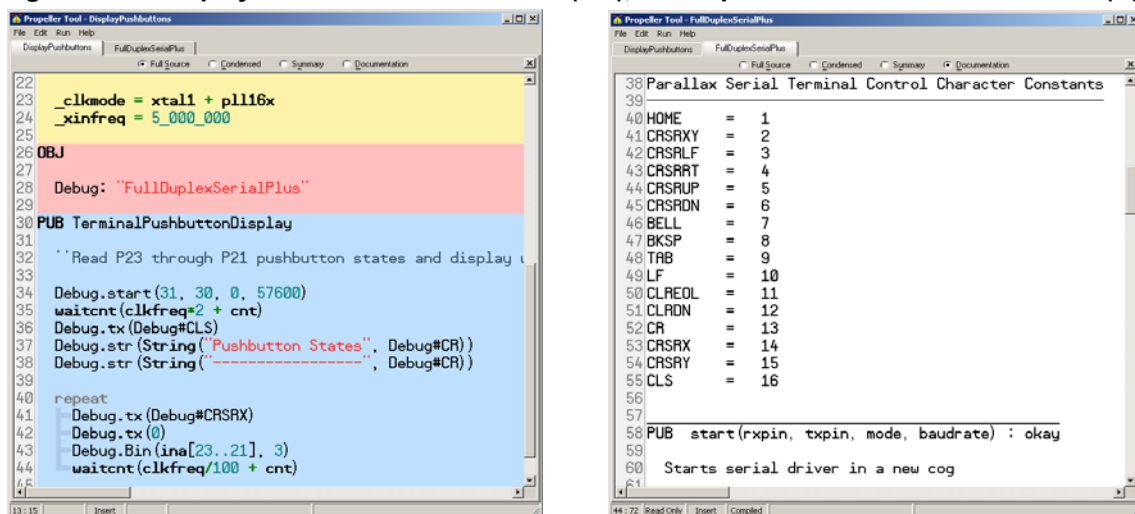

Terminal LED Output Control

Testing various actuators can also be important during prototyping. The `TerminalLedControl` object demonstrates a convenient means of setting output states for testing various output circuits. (See Figure 6-19.) While this example uses LED indicator lights, the I/O pin output signals could just as easily be sent to other chips' input pins, or inputs to circuits that control high-current outputs such as solenoids, relays, DC motors, heaters, lamps, etc.

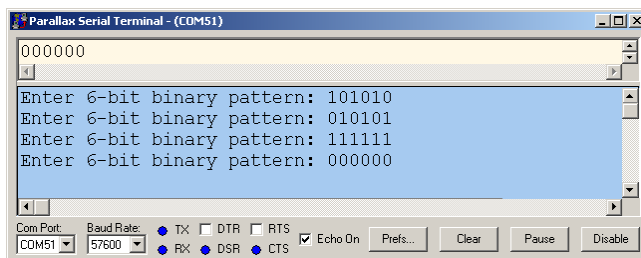

Figure 6-19: Entering Binary Patterns that Control I/O Pin Output States

The command `outa[9..4] := Debug.GetBin` calls the `FullDuplexSerialPlus` object's `GetBin` method. This method returns the value that corresponds to the binary characters (ones and zeros) you enter into the Parallax Serial Terminal's Transmit windowpane. The value the `GetBin` method returns is assigned to `outa[9..4]`, which makes the corresponding LED pattern light.

Objects Lab

- ✓ Use the Propeller Tool to Load TerminalLedControl.spin into EEPROM (F11), and immediately click the Parallax Serial Terminal's *Enable* button.
- ✓ Try entering the values shown in Figure 6-19 into the Transmit windowpane, and verify that the corresponding LED patterns light.

```
{
TerminalLedControl.spin

Enter LED states into Parallax Serial Terminal. Propeller chip receives the states and
lights the corresponding LEDs.

LED SCHEMATIC
-----
      (a11)
      100 Ω LED
P4 >--->--->--->
P5 >--->--->--->
P6 >--->--->--->
P7 >--->--->--->
P8 >--->--->--->
P9 >--->--->--->
                                |
                                |
                                |
                                v
                               GND
-----
}}

CON

_clkmode = xtal1 + pll16x
_xinfreq = 5_000_000

OBJ

Debug : "FullDuplexSerialPlus"

PUB TerminalLedControl

''Set/clear I/O pin output states based binary patterns
''entered into Parallax Serial Terminal.

Debug.start(31, 30, 0, 57600)
waitcnt(clkfreq*2 + cnt)
Debug.tx(Debug#CLS)
dira[4..9]~~

repeat

    Debug.Str(String("Enter 6-bit binary pattern: "))
    outa[4..9] := Debug.getBin
```

The DAT Block and Address Passing

One of the DAT block's uses is for storing sequences of values (including characters). Especially for longer messages and menu designs, keeping all the messages in a DAT block can be a lot more convenient than using `string("...")` in the code.



The **DAT Block** can also be used to store assembly language code that gets launched into a cog. For an example, take a look at FullDuplexSerial in Full Source view mode.

Below is the **DAT** block from the next example object, TestMessages. Notice how each line has a label, a size, and a sequence of values (characters in this case).

```
DAT
  MyString      byte    "This is test message number: ", 0
  MyOtherString byte    ", ", Debug#CR, "and this is another line of text.", 0
  BlankLine     byte    Debug#CR, Debug#CR, 0
```

Remember that the **string** directive returns the starting address of a string so that the FullDuplexSerial object's **str** method can start sending characters, and then stop when it encounters the zero-termination character. With **DAT** blocks, the zero termination character has to be manually added. The name of a given **DAT** block directive makes it possible to pass the starting address of the sequence using the **@** operator. For example, **@MyString** returns the address of the first character in the **MyString** sequence. So, **Debug.str(@MyString)** will start fetching and transmitting characters at the address of the first character in **MyString**, and will stop when it fetches the 0 that follows the "...number: " characters.

- ✓ Use the Propeller Tool to load the TestMessages.spin object into EEPROM (F11), and then immediately click the Parallax Serial Terminal's *Enable* button.
- ✓ Verify that the three messages are displayed once every second.

```
`` TestMessages.spin
`` Send text messages stored in the DAT block to Parallax Serial Terminal.

CON
  _clkmode = xtal1 + pll16x
  _xinfreq = 5_000_000

OBJ
  Debug: "FullDuplexSerialPlus"

PUB TestDatMessages | value, counter

  `` Send messages stored in the DAT block.

  Debug.start(31, 30, 0, 57600)
  waitcnt(clkfreq*2 + cnt)
  Debug.tx(Debug#CLS)

  repeat
    Debug.Str(@MyString)
    Debug.Dec(counter++)
    Debug.Str(@MyOtherString)
    Debug.Str(@BlankLine)
    waitcnt(clkfreq + cnt)

DAT
  MyString      byte    "This is test message number: ", 0
  MyOtherString byte    ", ", Debug#CR, "and this is another line of text.", 0
  BlankLine     byte    Debug#CR, Debug#CR, 0
```

Expanding the DAT Section and Accessing its Elements

Here is a modified **DAT** section. The text messages have different content and different label names. In addition, there is a **ValueList** with long elements instead of byte elements.

Objects Lab

DAT

```
ValTxt      byte   Debug#CR, "The value is: ", 0
ElNumTxt    byte   ", ", Debug#CR, "and its element #: ", 0
ValueList   long   98, 5282, 299_792_458, 254, 0
BlankLine   byte   Debug#CR, 0
```

Individual elements in the list can be accessed with **long**, **word**, or **byte**. For example, `long[@ValueList]` would return the value 98, the first long. There's also an optional offset that can be added in a second bracket for accessing successive elements in the list. For example:

```
value := long[@ValueList][0]   ' copies 98 to the value variable
value := long[@ValueList][1]   ' copies 5282 to the value variable
value := long[@ValueList][2]   ' copies 299_792_458 to value
```



The long, word, and byte keywords have different uses in different types of blocks.

In VAR blocks, **long**, **word** and **byte** can be used to declare three different size variables. In DAT blocks, **long**, **word**, and **byte** can be used to declare the element size of lists. In PUB and PRI methods, **long**, **word**, and **byte** are used to retrieve values at certain addresses.

- ✓ Make a copy of the TestMessages object, and replace the DAT section with the one above. Replace the PUB section with the one shown below.

```
PUB TestDatMessages | value, index

Debug.start(31, 30, 0, 57600)
waitcnt(clkfreq*2 + cnt)
Debug.tx(Debug#CLS)

repeat
  repeat index from 0 to 4
    Debug.Str(@ValTxt)
    value := long[@valueList][index]
    Debug.Dec(value)
    Debug.Str(@ElNumTxt)
    Debug.Dec(index)
    Debug.Str(@BlankLine)
    waitcnt(clkfreq + cnt)
```

- ✓ Test the modified object with the Propeller chip and Parallax Serial Terminal. Note how an index variable is used in `long[@ValueList][index]` to return successive elements in the ValueList.

The Float and FloatString Objects

Floating-point is short for floating decimal point, and it refers to values that might contain a decimal point, preceded and/or followed by some number of digits. The IEEE754 single precision (32-bit) floating-point format is supported by the Propeller Tool software and by the Float and FloatString Propeller Library objects. This format uses a certain number of bits in a 32-bit variable for a number's significant digits, other bits to store the exponent, and a single bit to store the value's sign.

While calculations involving two single-precision floating-point values aren't as precise as those involving two 32-bit variables, it's great when you have fractional values to the right of the decimal point, including very large and small magnitude numbers. For example, while signed long variables can hold integers from -2,147,483,648 to 2,147,483,647, single-precision floating-point values can represent values as large as $\pm 3.403 \times 10^{38}$, or as small as $\pm 1.175 \times 10^{-38}$.

For this lab, it's just important to know that the Propeller Library has objects that can be used to process floating-point values. `TerminalFloatStringTest` demonstrates some basic floating-point operations. First, `a := 1.5` and `b := pi` are using the Propeller Tool software's ability to recognize floating point values to pre-assign the floating-point version of 1.5 to the variable `a` and `pi` (3.141593) to `b`. Then, it uses the `FloatMath` object to add the floating-point values stored by the variables `a` and `b`. Finally, it uses the `FloatString` object to display the result, which gets stored in `c`.

- ✓ Use the Propeller Tool to load the `FloatStringTest.spin` object into EEPROM (F11), and then immediately click the Parallax Serial Terminal's *Enable* button.
- ✓ Verify that the Parallax Serial Terminal's Receive windowpane displays `1.5 + Pi = 4.641593`.

```

''FloatStringTest.spin
''Solve a floating point math problem and display the result with Parallax Serial
''Terminal.

CON

  _clkmode = xtal1 + pll16x
  _xinfreq = 5_000_000

OBJ

  Debug   : "FullDuplexSerialPlus"
  fMath   : "FloatMath"
  fString : "FloatString"

PUB TwoWayCom | a, b, c

  '' Solve a floating point math problem and display the result.

  Debug.start(31, 30, 0, 57600)
  Waitcnt(clkfreq*2 + cnt)
  Debug.tx(Debug#CLS)

  a := 1.5
  b := pi

  c := fmath.FAdd(a, b)

  Debug.str(String("1.5 + Pi = "))

  debug.str(fstring.FloatToString(c))

```

Objects that Use Variable Addresses

Like elements in `DAT` blocks, variables also have addresses in RAM. Certain objects are designed to be started with variable address parameters. They often run in separate cogs, and either update their outputs based on a value stored in the parent object's variable(s) or update the parent object's variables based on measurements or incoming data, or both.

`AddressBlinker` is an example of an object that fetches values from its parent object's variables. Note that its `Start` method has parameters for two address values, `pinAddress` and `rateAddress`. The parent object has to pass the `AddressBlinker` object's `Start` method the address of a variable that stores the I/O pin number, and another that stores the rate. The `Start` method relays these parameters to the `Blink` method via the method call in the `cognew` command. So, when the `Blink` method gets launched into a new cog, it also receives copies of these addresses. Each time through the `Blink`

Objects Lab

method's `repeat` loop, it check's the values stored in its parent object's variables with `pin := long[rateAddress]` and `rate := long[rateAddress]`. Note that since the `pinAddress` and `rateAddress` already store addresses, the `@` operator is no longer needed.



Global vs. Local Variables: In this program, the `pinAddress` and `rateAddress` variables are passed to the `Start` method by the parent object as parameters. The `Start` method relays these values to the `Blink` method as parameters too. Both the `Start` and `Blink` methods end up with their own `pinAddress` and `rateAddress` local variables because local variables are only accessible by the method that declares them.

Another common practice is to make the `Start` method copy parameters it receives to global variables declared in the object's `VAR` block. Other methods in the object can then read from and write to these global variables as needed. Keep in mind that different cogs might be executing code in different methods. Even so, both methods can still work with an object's global variables. An example of this important practice is demonstrated in the next lab's Inside the MonitorPWM Object section on page 164.

- ✓ Examine the `AddressBlinker.spin` object and pay careful attention to the variable interactions just discussed.

```
'' File: AddressBlinker.spin
'' Example cog manager that watches variables in its parent object

VAR
  long  stack[10]           'Cog stack space
  byte  cog                'Cog ID

PUB Start(pinAddress, rateAddress) : success
'' Start new blinking process in new cog; return True if successful.
'' Parameters: pinAddress - long address of the variable that stores the I/O pin
''              rateAddress - long address of the variable that stores the rate
  Stop
  success := (cog := cognew(Blink(pinAddress, rateAddress), @stack) + 1)

PUB Stop
'' Stop blinking process, if any.

  if Cog
    cogstop(Cog~ - 1)

PRI Blink(pinAddress, rateAddress) | pin, rate, pinOld, rateOld

  pin      := long[pinAddress]
  rate     := long[rateAddress]
  pinOld   := pin
  rateOld  := rate

  repeat
    pin := long[pinAddress]
    dira[pin]~~
    if pin <> pinOld
      dira[pinOld]~
      !outa[pin]
    pinOld := pin
    rate := long[rateAddress]
    waitcnt(rate/2 + cnt)
```

The `AddressBlinkerControl` object demonstrates one way of declaring variables, assigning their values, and passing their addresses to an object that will monitor them, the `AddressBlinker` object in this case. After it passes the addresses of its `pin` and `rateDelay` variables to `AddressBlinker`'s `Start`

method, the AddressBlinker object checks these variables between each LED state change. If the value of either `pin` or `rateDelay` has changed, AddressBlinker detects this and updates the LED's pin or blink rate accordingly.

- ✓ Use the Propeller Tool to load the AddressBlinkerControl.spin object into EEPROM (F11), and then immediately click the Parallax Serial Terminal's *Enable* button.
- ✓ Enter the pin numbers and delay clock ticks shown in Figure 6-20 into the Parallax Serial Terminal's Transmit windowpane, and verify that the application correctly selects the LED and determines its blink rate.

As soon as you press enter, the AddressBlinker object will update based on the new value stored in the AddressBlinkerControl object's `pin` or `rateDelay` variables.

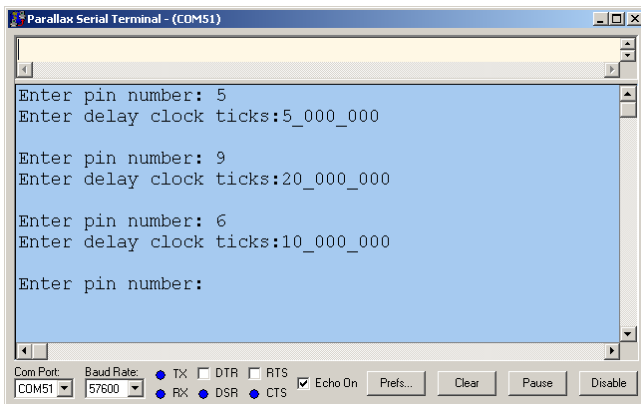

Figure 6-20: Entering Pin and Rate into Serial Terminal

```

'' AddressBlinkerControl.spin
'' Enter LED states into Parallax Serial Terminal and send to Propeller chip via
'' Parallax Serial Terminal.

CON

  _clkmode = xtall + pll16x
  _xinfreq = 5_000_000

OBJ

  Debug:    "FullDuplexSerialPlus"
  AddrBlnk: "AddressBlinker"

VAR

  long pin, rateDelay

PUB UpdateVariables

  '' Update variables that get watched by AddressBlinker object.

  Debug.start(31, 30, 0, 57600)
  waitcnt(clkfreq*2 + cnt)
  Debug.tx(Debug#CLS)

  pin := 4
  rateDelay := 10_000_000

```

```
AddrBlnk.start(@pin, @rateDelay)

dira[4..9]~~

repeat

    Debug.Str(String("Enter pin number: "))
    pin := Debug.getDec
    Debug.Str(String("Enter delay clock ticks:"))
    rateDelay := Debug.getDec
    Debug.Str(String(Debug#CR))
```

Displaying Addresses

In `AddressBlinkerControl`, the values of `pin` and `rateDelay` can be displayed with `Debug.Dec(pin)` and `Debug.Dec(rateDelay)`. The addresses of `pin` and `rateDelay` can be displayed with `Debug.Dec(@pin)` and `Debug.Dec(@rateDelay)`.

- ✓ Insert commands that display the addresses of the `pin` and `rateDelay` variables in Parallax Serial Terminal just before the `repeat` loop starts, and display the value of those variables each time they are entered. Note: The point of this exercise is to reinforce the distinction between a variable's contents and its address.

Passing Starting Addresses to Objects that Work with Variable Lists

Some objects monitor or update long lists of variables from another cog, in which case, they typically have documentation that explains the order and size of each variable that the parent object needs to declare. This kind of object's `start` method typically just expects one value, the starting address of the list of variables in the parent object. The child object takes that one address and uses address offsets to access the rest of the variables in the parent object's list.

`AddressBlinkerWithOffsets` is an example of an object whose `start` method expects the starting address of a variable list. Unlike `AddressBlinker`, its `start` method just receives the address of the parent object's long variable that stores the `pin` value. Its documentation requires the long variable storing the blink rate delay to be declared next, with no extra variables between.

Since the `baseAddress` parameter stores the address of the parent object's variable that stores the pin number, `long[baseAddress][0]` will access this value. Likewise, `long[baseAddress][1]` will access the variable that stores the blink rate. That's how this program fetches both variable values with just one address parameter.

- ✓ Examine the `AddressBlinkerWithOffsets.spin` object. Note how its `start` method requires a `baseAddress` that it uses to find variables in its parent object that determine the pin and delay in the blink rate.
- ✓ Consider how this could be applied to longer lists of variables using address offsets.

```
'' File: AddressBlinkerWithOffsets.spin
'' Example cog manager that watches variables in its parent object
'' Parent object should declare a long that stores the LED I/O pin number
'' followed by a long that stores the number of click ticks between each
'' LED state change. It should pass the address of the long that stores
'' the LED I/O pin number to the Start method.

VAR
    long stack[10]           'Cog stack space
    byte cog                 'Cog ID
```

```

PUB Start(baseAddress) : success
  ''Start new blinking process in new cog; return True if successful.
  ''baseAddress.....the address of the long variable that stores the LED pin number.
  ''baseAddress + 1...the address of the long variable that stores the blink rate delay.

  Stop
  success := (cog := cognew(Blink(baseAddress), @stack) + 1)

PUB Stop
  ''Stop blinking process, if any.

  if Cog
    cogstop(Cog~ - 1)

PRI Blink(baseAddress) | pin, rate, pinOld, rateOld

  pin      := long[baseAddress][0]
  rate     := long[baseAddress][1]
  pinOld   := pin
  rateOld  := rate

  repeat
    pin := long[baseAddress][0]
    dira[pin]~~
    if pin <> pinOld
      dira[pinOld]~
      !outa[pin]
    pinOld := pin
    rate := long[baseAddress][1]
    waitcnt(rate/2 + cnt)

```

Keep in mind that the point of this example is to demonstrate how a parent object can pass a base address to a child object whose documentation requires a list of variables of specified sizes that hold certain values and are declared in a certain order. The `AddressBlinkerControlWithOffsets` object works with the `AddressBlinkerWithOffsets` object in this way to perform the same application featured in the previous example, terminal-controlled LED selection and blink rate. In keeping with the `AddressBlinkerWithOffsets` object's documentation, `AddressBlinkerControlWithOffsets` declares a long variable to store `pin`, and the next long variable it declares is `rateDelay`. Then, it passes the address of its `pin` variable to the `AddressBlinkerControl` object's `Start` method.

In this object, the variable declaration `long pin, rateDelay` is crucial. If the order of these two variables were swapped, the application wouldn't work right. Again, that's because the `AddressBlinkerWithOffsets` object expects to receive the address of a long variable that stores the `pin` value, and it expects the next consecutive long variable to store the `rateDelay` variable. Now, it's perfectly fine to declare long variables before and after these two. It's just that `pin` and `rateDelay` have to be long variables, and they have to be declared in the order specified by `AddressBlinkerWithOffsets`. The starting address of the variable list also has to get passed to the child object's `start` method, in this case with `AddrBlnk.start(@pin)`. Keep an eye open for this approach in objects that are designed to work with long lists of variables in their parent objects.

- ✓ Test `AddressBlinkerControlWithOffsets` and verify that it is functionally identical to `AddressBlinkerControl`.
- ✓ Examine how `AddressBlinkerControlWithOffsets` is designed in accordance with the `AddressBlinkerWithOffsets` object's documentation.

Objects Lab

```
.. File: AddressBlinkerControlWithOffsets.spin
..
.. Another example cog manager that relies on an object that watches variables in its
.. parent object.
..
.. This one's start method only passes one variable address, but uses it as an anchor
.. for two variables that are monitored by AddressBlinkerWithOffsets.

CON

  _clkmode = xtall + pll16x
  _xinfreq = 5_000_000

VAR

  long pin, rateDelay

OBJ

  Debug:    "FullDuplexSerialPlus"
  AddrBlnk: "AddressBlinkerWithOffsets"

PUB TwoWayCom

  .. Send test messages and values to Parallax Serial Terminal.

  Debug.start(31, 30, 0, 57600)
  waitcnt(clkfreq*2 + cnt)
  Debug.tx(Debug#CLS)

  pin := 4
  rateDelay := 10_000_000

  AddrBlnk.start(@pin)

  dira[4..9]~~

  repeat

    Debug.Str(String("Enter pin number: "))
    pin := Debug.getDec
    Debug.Str(String("Enter delay for 'rate':"))
    rateDelay := Debug.getDec
    Debug.tx(Debug#CR)
```

Study Time

Questions

- 1) What are the differences between calling a method in the same object and calling a method in another object?
- 2) Does calling a method in another object affect the way parameters and return values are passed?
- 3) What file location requirements have to be satisfied before one object can successfully declare another object?
- 4) Where can object hierarchy in your application be viewed?
- 5) How are documentation comments included in an object?
- 6) How do you view an object's documentation comments while filtering out code?
- 7) By convention, what method names do objects use for launching methods into new cogs and shutting down cogs?

- 8) What if an object manages one process in one new cog, but you want more than one instance of that process launched in multiple cogs?
- 9) What is the net effect of an object's `Start` method calling its `Stop` method?
- 10) How are custom characters for schematics, measurements, mathematical expressions and timing diagrams entered into object comments?
- 11) What's the differences between a public and private method?
- 12) How do you declare multiple copies of the same object?
- 13) Where are Propeller Library objects stored?
- 14) How do you view Object Interface information?
- 15) Where in RAM usage does the `String` directive cause character codes to be stored?
- 16) Why are zero-terminated strings important for the `FullDuplexSerial` object?
- 17) What should an object's documentation comments explain about a method?
- 18) How can character strings be stored, other than with the `String` declaration?
- 19) What are the three different uses of the `long`, `word` and `byte` keywords in the Spin language?
- 20) What method does the `Float` object use to add two floating-point numbers?
- 21) What object's methods can be used to display floating-point numbers as strings of characters?
- 22) Is the command `a := 1.5` processed by the `FloatMath` object?
- 23) How does a variable's address get passed to a parameter in another object's method?
- 24) How can passing an address to an object's method reduce the number of parameters required?
- 25) Given a variable's address, how does an object's method access values stored in that variable and variables declared after it?
- 26) Given an address, can an object monitor a variable value?
- 27) Given an address, can an object update the variable in another object using that address?

Exercises

- 1) Given the file `MyLedObject.spin`, write a declaration for another object in the same folder so that it can use its methods. Use the nickname `led`.
- 2) Write a command that calls a method named `on` in an object nicknamed `led`. This method requires a `pin` parameter (use 4).
- 3) List the decimal values of the Parallax font characters required to write this expression in a documentation comment `f = T4`.
- 4) Declare a private method named `calcArea` that accepts parameters `height` and `width`, and returns `area`.
- 5) Declare five copies of an object named `FullDuplexSerial` (which could be used for five simultaneous serial communication bidirectional serial connections). Use the nickname `uart`.
- 6) Call the third `FullDuplexSerial` object's `str` method, and send the string "Hello!!!". Assume the nickname `uart`.
- 7) Write a `DAT` block and include a string labeled `Hi` with the zero terminated string "Hello!!!".
- 8) Write a command that calculates the circumference (`c`) of a circle given the diameter (`d`). Assume the `FloatMath` object has been nicknamed `f`.
- 9) Given the variable `c`, which stores a floating-point value, pass this to a method in `FloatString` that returns the address of a stored string representation of the floating point value. Store this address in a variable named `address`. Assume the nickname `fst`.

Projects

- 1) The `TestBs2IoLiteObject` uses method calls that are similar to the BASIC Stamp microcontroller's PBASIC programming language commands. This object needs a `Bs2IoLite` object with methods like `high`, `pause`, `low`, `in`, and `toggle`. Write an object that supports these method calls using the descriptions in the comments.

```
``Top File: TestBs2IoLiteObject.spin
```

Objects Lab

```
``Turn P6 LED on for 1 s, then flash P5 LED at 5 Hz whenever the  
``P21 pushbutton is held down.
```

OBJ

```
stamp : "Bs2IoLite"
```

PUB ButtonBlinkTime | time, index

```
stamp.high(6)          * Set P6 to output-high  
stamp.pause(1000)     * Delay 1 s  
stamp.low(6)          * Set P6 to output-low  
stamp.low(5)          * Set P5 to output-low  
repeat                * Repeat (like DO...LOOP in PBASIC)  
  if stamp.in(21)     * If P21 pushbutton pressed  
    stamp.toggle(5)   * Toggle P5 output state  
  else  
    stamp.low(5)      * Delay 0.1 s before repeat  
    stamp.pause(100)
```

- 2) Examine the Stack Length object in the Propeller Library, and the Stack Length Demo in the Propeller Library Demo folders. Make a copy of Stack Length Demo.spin, and modify it to test the stack space required for launching the Blinker object's Blink method (from the beginning of this lab) into a cog. Create a Parallax Serial Terminal connection based on StackLenthDemo's documentation to display the result. *NOTE: The instructions for using the Stack Length object are hidden in its THEORY OF OPERATION comments, which are visible in documentation view mode.*
- 3) Some applications will have a clock running in a cog for timekeeping. Below is a terminal display that gets updated each time the PE Platform's P23 pushbutton is pressed and released.

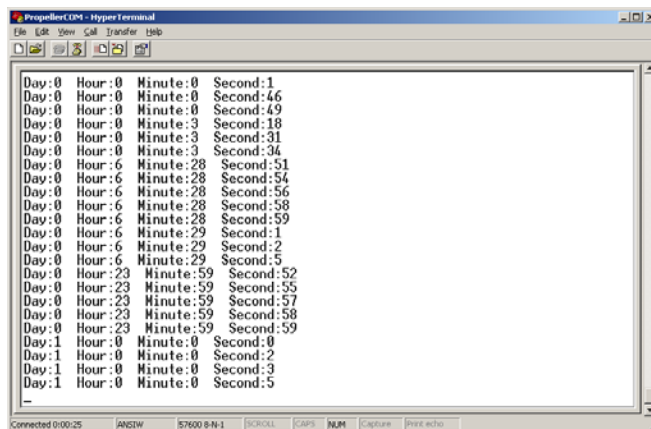

```
PropellerCDS - HyperTerminal  
File Edit View Call Transfer Help  
Day:0 Hour:0 Minute:0 Second:1  
Day:0 Hour:0 Minute:0 Second:46  
Day:0 Hour:0 Minute:0 Second:49  
Day:0 Hour:0 Minute:3 Second:18  
Day:0 Hour:0 Minute:3 Second:31  
Day:0 Hour:0 Minute:3 Second:34  
Day:0 Hour:6 Minute:28 Second:51  
Day:0 Hour:6 Minute:28 Second:54  
Day:0 Hour:6 Minute:28 Second:56  
Day:0 Hour:6 Minute:28 Second:58  
Day:0 Hour:6 Minute:28 Second:59  
Day:0 Hour:6 Minute:29 Second:1  
Day:0 Hour:6 Minute:29 Second:2  
Day:0 Hour:6 Minute:29 Second:5  
Day:0 Hour:23 Minute:59 Second:52  
Day:0 Hour:23 Minute:59 Second:55  
Day:0 Hour:23 Minute:59 Second:57  
Day:0 Hour:23 Minute:59 Second:58  
Day:0 Hour:23 Minute:59 Second:59  
Day:1 Hour:0 Minute:0 Second:0  
Day:1 Hour:0 Minute:0 Second:2  
Day:1 Hour:0 Minute:0 Second:3  
Day:1 Hour:0 Minute:0 Second:5  
Connected 0:00:25  ANSIW  57600 8-N-1  [CTRL]  [COPY]  [PASTE]  [Print]  [Close]
```

The Parallax Serial Terminal gets updated by the TerminalButtonLogger.spin object below. There are two calls to the TickTock object. The first is call is Time.Start(0, 0, 0, 0), which initializes the TickTock object's day, hour, minute, and second variables. The second method call is Time.Get(@days, @hours, @minutes, @seconds). This method call passes the TickTock object the addresses of the TerminalButtonLogger object's days, hours, minutes, and seconds variables. The TickTock object updates these variables with the current time. Your task in this project is to write the TickTock object that works with the TerminalButtonLogger object. Make sure to use the second counting technique from the GoodTimeCount method from the I/O and Timing lab.

```

'' TerminalButtonLogger.spin
'' Log times the button connected to P23 was pressed/released in
'' Parallax Serial Terminal.

CON
  _clkmode = xtall + pll16x
  _xinfreq = 5_000_000

OBJ
  Debug      : "FullDuplexSerialPlus"
  Button     : "Button"
  Time       : "TickTock"

VAR
  long days, hours, minutes, seconds

PUB TestDatMessages

  Debug.start(31, 30, 0, 57600)      ' Start FullDuplexSerialPlus object.
  waitcnt(clkfreq*3 + cnt)         ' Wait for three seconds.
  Debug.tx(Debug#CLS)

  Time.Start(0, 0, 0, 0)           ' Start the TickTock object and initialize
                                  ' the day, hour, minute, and second.
  Debug.Str(@BtnPrompt)           ' Display instructions in Parallax Serial
Terminal
  repeat

    if Button.Time(23)             ' If button pressed.
      ' Pass variables to TickTock object for update.
      Time.Get(@days, @hours, @minutes, @seconds)
      DisplayTime                 ' Display the current time.

PUB DisplayTime

  Debug.tx(Debug#CR)
  Debug.Str(String("Day:"))
  Debug.Dec(days)
  Debug.Str(String(" Hour:"))
  Debug.Dec(hours)
  Debug.Str(String(" Minute:"))
  Debug.Dec(minutes)
  Debug.Str(String(" Second:"))
  Debug.Dec(seconds)

DAT

BtnPrompt  byte  Debug#CLS, "Press/release P23 pushbutton periodically...", 0

```

7: Counter Modules and Circuit Applications Lab

Introduction

Each Propeller cog has two *counter modules*, and each counter module can be configured to independently perform repetitive tasks. So, not only does the Propeller chip have the ability to execute code simultaneously in separate cogs, each cog can also orchestrate up to two additional processes with counter modules while the cog continues executing program commands. Counters can provide a cog with a variety of services; here are some examples:

- Measure pulse and decay durations
- Count signal cycles and measure frequency
- Send numerically-controlled oscillator (NCO) signals, i.e. square waves
- Send phase-locked loop (PLL) signals, which can be useful for higher frequency square waves
- Signal edge detection
- Digital to analog (D/A) conversion
- Analog to digital (A/D) conversion
- Provide internal signals for video generation

Since each counter module can be configured to perform many of these tasks in a “set it and forget it” fashion, it is possible for a single cog to execute a program while at the same time do things like generate speaker tones, control motors and/or servos, count incoming frequencies, and transmit and/or measure analog voltages.

This lab provides examples of how to use ten of the thirty-two different counter modes to perform variations of eight different tasks:

- RC decay time measurement for potentiometers and photoresistor
- D/A conversion to control LED brightness
- NCO signals to send speaker tones
- NCO signals for modulated IR for object and distance detection
- Count speaker tone cycles
- Detect a signal transition
- Pulse width control
- Generate-high frequency signals for metal proximity detection

A cog doesn’t necessarily have to “set and forget” a counter module. It can also dedicate itself to processes involving counter modules to do some amazing things, including a number of audio and video applications. This lab also includes an example that demonstrates this kind of cog-counter relationship, applied to sending multiple PWM signals.

Prerequisite Labs

- Setup and Testing
- I/O and Timing
- Methods and Cogs
- Objects

How Counter Modules Work

Each cog has two counter modules, Counter A and Counter B. Each cog also has three 32-bit special purpose registers for each of its counter modules. The Counter A special purpose registers are **phsa**, **frqa**, **ctra**, and Counter B's are **phsb**, **frqb** and **ctrb**. Note that each counter name is also a reserved word in Spin and Propeller assembly. If this lab is referring to a register generally, but it doesn't matter whether it's for Counter A or Counter B, it will use the generic names PHS, FRQ, and CTR.

Here is how each of the three registers works in a counter module:

- PHS – the “phase” register gets updated every clock tick. A counter module can also be configured make certain PHS register bits affect certain I/O pins.
- FRQ – the “frequency” register gets conditionally added to the PHS register every clock tick. The counter module's mode determines what conditions cause FRQ to get added to PHS. Mode options include “always”, “never”, and conditional options based on I/O pin states or transitions.
- CTR – the “control” register configures both the counter module's mode and the I/O pin(s) that get monitored and/or controlled by the counter module. Each counter module has 32 different modes, and depending on the mode, can monitor and/or control up to two I/O pins.

Measuring RC Decay with a Positive Detector Mode

Resistor-Capacitor (RC) decay is useful for a variety of sensor measurements. Some examples include:

- Dial or joystick position with one or more potentiometers
- Ambient light levels with either a light-dependent resistor or a photodiode
- Surface infrared reflectivity with an infrared LED and phototransistor
- Pressure with capacitor plates and a compressible dielectric
- Liquid salinity with metal probes

RC Decay Circuit

RC decay measurements are typically performed by charging a capacitor (**C**) and then monitoring the time it takes the capacitor to discharge through a resistor (**R**). In most RC decay circuits, one of the values is fixed, and the other varies with an environmental variable. For example, the circuit in Figure 7-1 is used to measure a potentiometer knob's position. The value of C is fixed at 0.01 μF , and the value of R varies with the position of the potentiometer's adjusting knob (the environmental variable).

- ✓ Build the circuit shown in Figure 7-1 on your PE Platform. This circuit and all others in this lab are in addition to the basic Propeller circuit built in the Setup and Testing lab.

Figure 7-1: RC Decay Parts and Circuit

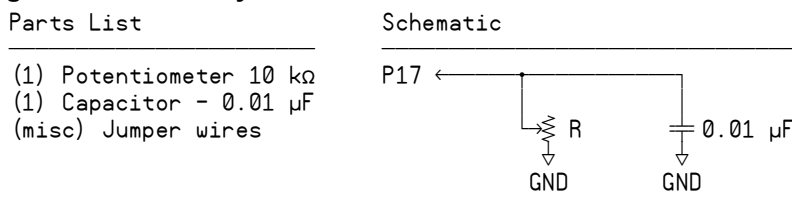

Measuring RC Decay

Before taking the RC decay time measurement, the Propeller chip needs to set the I/O pin connected to the circuit to output-high. This charges the capacitor up to 3.3 V as shown on the left side of Figure 7-2. Then, the Propeller chip starts the RC decay measurement by setting the I/O pin to input, as shown on the right side of Figure 7-2. When the I/O pin changes to input, the charge built up in the capacitor drains through the variable resistor. The time it takes the capacitor to discharge from 3.3 V down to the I/O pin's 1.65 V threshold is:

$$\Delta t = 0.693 \times C \times R$$

Since 0.693 and C are constants, the time Δt it takes for the circuit to decay is directly proportional to R, the variable resistor's resistance.

Figure 7-2: RC Charge and Decay Circuits and Voltages

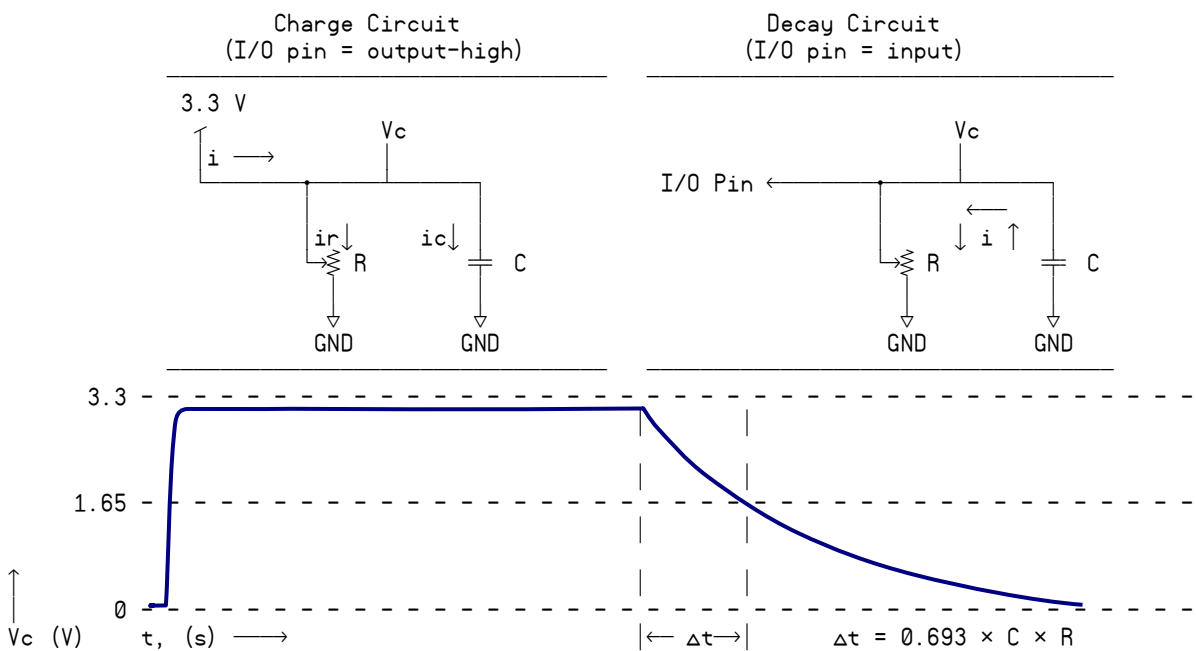

Where is the current-limiting series resistor?

The Propeller chip's I/O pin driver circuits do not need to be protected from the sudden initial current spike that results when the I/O pin is taken from either output-low or input to output-high. The I/O pins' output capacity and current-limiting characteristics prevent any damage from occurring.



If you try to use this circuit with a different microcontroller, you will probably need to include a current-limiting resistor between the I/O pin and the RC circuit. Make sure that it is large enough to prevent the I/O pin from getting damaged. The decay time won't be linear because the voltage divider created by the second resistor causes the RC decay measurement's starting voltage to vary. Choosing an R in the RC circuit that is very large compared to the series resistor will help the decay time more closely resemble a linear behavior.

Positive Detector Modes

There are two positive detector mode options, "regular" and "with feedback." In regular positive detector mode, the Propeller chip's counter module monitors an I/O pin, and adds FRQ to PHS for every clock tick in which the pin is high. To make the PHS register accumulate the number of clock ticks in which the pin is high, simply set the counter module's FRQ register to 1. For measuring RC

Counter Modules and Circuit Applications Lab

decay, the counter module should start counting (adding $FRQ = 1$ to PHS) as soon as the I/O pin is changed from output-high to input. After the signal level decays below the I/O pin's 1.65 V logic threshold, the module no longer adds FRQ to PHS, and what's stored in PHS is the decay time measurement in system clock ticks.

One significant advantage to using a counter module to measure RC decay is that the cog doesn't have to wait for the decay to finish. Since the counter automatically increments PHS with every clock tick in which the pin is high, the program is free to move on to other tasks. The program can then get the value from the PHS register whenever it's convenient.

Configuring a Counter Module for Positive Detector Mode

Figure 7-3 shows excerpts from the Propeller Library's CTR object's Counter Mode Table. The CTR object has counter module information and a code example that generates square waves. The CTR object's Counter Mode Table lists the 32 counter mode options, seven of which are shown below. The mode we will use for the RC decay measurement is positive detector (without feedback), shown as "POS detector" in the table excerpts.

Figure 7-3: Excerpts from the CTR.spin's Counter Mode Table

CTRMODE	Description	Accumulate FRQ to PHS	APIN output*	BPIN output*
%00000	Counter disabled (off)	0 (never)	0 (none)	0 (none)
.
%01000	POS detector	A^1	0	0
%01001	POS detector w/feedback	A^1	0	$!A^1$
%01010	POSEDGE detector	A^1 & $!A^2$	0	0
%01011	POSEDGE detector w/feedback	A^1 & $!A^2$	0	$!A^1$
.
%11111	LOGIC always	1	0	0

* must set corresponding DIR bit to affect pin

- A^1 = APIN input delayed by 1 clock
- A^2 = APIN input delayed by 2 clocks
- B^1 = BPIN input delayed by 1 clock

Notice how each counter mode in Figure 7-3 has a corresponding 5-bit CTRMODE code. For example, the code for "POS detector" is %01000. This value has to be copied to a bit field within the counter module's CTR register to make it function in "POS detector" mode. Figure 7-4 shows the register map for the `ctra` and `ctrb` registers. Notice how the register map names bits 31..26 CTRMODE. These are the bits that the 5-bit code from the CTRMODE column in Figure 7-3 have to be copied to in order to make a counter module operate in a particular mode.

Figure 7-4: CTRA/B Register Map from CTR.spin

bits	31	30..26	25..23	22..15	14..9	8..6	5..0
Name	—	CTRMODE	PLLDIV	—	BPIN	—	APIN

7: Counter Modules and Circuit Applications Lab

Like the `dira`, `outa` and `ina` registers, the `ctra` and `ctrb` registers are bit-addressable, so the procedure for setting and clearing bits in this register is the same as it would be for a group I/O pin operations with `dira`, `outa`, or `ina`. For example, here's a command to make Counter A a "POS detector":

```
ctra[30..26] := %01000
```



The Counter Mode Table and CTRA/B Register Map appear in the Propeller Library's CTR object, and also in the *Propeller Manual's* CTRA/B section, located in the Spin Reference chapter. APIN and BPIN are I/O pins that the counter module might control, monitor, or not use at all, depending on the mode.

Notice also in Figure 7-4 how there are bit fields for PLLDIV, BPIN, and APIN. PLLDIV is short for "phase-locked loop divider" and is only used for PLL counter modes, which can synthesize high-frequency square waves (more on this later). APIN (and BPIN for two-pin modes) have to store the I/O pin numbers that the counter module will monitor/control. In the case of the Counter A module set to POS detector mode, `frqa` gets added to `phsa` based on the state of APIN during the previous clock. (See the A¹ reference and footnote in Figure 7-3.) So the APIN bit field needs to store the value 17 since P17 will monitor the RC circuit's voltage decay. Here's a command that sets bits 5..0 of the `ctra` register to 17:

```
ctra[5..0] := 17
```

Remember that `frqa` gets added to `phsa` with every clock tick where APIN was high. To make the counter module track how many clock ticks the pin is high, simply set `frqa` to 1:

```
frqa := 1
```

At this point, the `phsa` register gets 1 added to it for each clock tick in which the voltage applied to P17 is above the Propeller chip's 1.65 V logic threshold. The only other thing you have to do before triggering the decay measurement is to clear the `phsa` register.

In summary, configuring the counter module to count clock ticks when an I/O pin is high takes three steps:

- 1) Store %01000 in the CTR register's CTRMODE bit field:

```
ctra[30..26] := %01000
```

- 2) Store the I/O pin number that you want monitored in the CTR register's APIN bit field:

```
ctra[5..0] := 17
```

- 3) Store 1 in the FRQ register so that the `phsa` register will get 1 added to it for every clock tick that P17 is high:

```
frqa := 1
```

1 isn't the only useful FRQ register value. Other FRQ register values can also be used to prescale the sensor input for calculations or even for actuator outputs. For example, FRQ can instead be set to `clkfrq/1_000_000` to count the decay time in microseconds.

```
frqa := clkfrq/1_000_000
```

Counter Modules and Circuit Applications Lab

This expression works for Propeller chip system clock frequencies that are common multiples of 1 MHz. For example, it would work fine with a 5.00 MHz crystal input, but not with a 4.096 MHz crystal since the resulting system clock frequency would not be an exact multiple of 1 MHz.

One disadvantage of larger FRQ values is that the program cannot necessarily compensate for the number of clock ticks between clearing the PHS register and setting the I/O pin to input. A command that compensates for this source of error can easily be added after the clock tick counting is finished, and it can be followed by a second command that scales to a convenient measurement unit, such as microseconds.



Measure input or output signals. This counter mode can be used to measure the duration in which an I/O pin sends a high signal as well as the duration in which a high signal applied to the I/O pin. The only difference is the direction of the I/O pin when the measurement is taken.

“Counting” the RC Decay Measurement

Before the RC decay measurement, the capacitor should be charged. Here’s a piece of code that sets P17 to output-high, then waits for 10 μ s, which is more than ample for charging the capacitor in the Figure 7-1 RC network.

```
dira[17] := outa[17] := 1
waitcnt(clkfreq/100_000 + cnt)
```

To start the decay measurement, clear the PHS register, and then set the I/O pin that’s charging the capacitor to input:

```
phsa~
dira[17]~
```

After clearing **phsa** and **dira**, the program is free to perform other tasks during the measurement. At some later time, the program can come back and copy the **phsa** register contents to a variable. Of course, the program should make sure to wait long enough for the decay measurement to complete. This can be done by polling the clock, waiting for the decay pin to go low, or performing a task that is known to take longer than the decay measurement.

To complete the measurement, copy the **phsa** register to another variable and subtract 624 from it to account for the number of clock ticks between **phsa~** and **dira[17]~**. The result of this subtraction can also be set to a minimum of 0 with **#> 0**. This will make more sense than -624 when the resistance is so low that it pulls the I/O pin’s output-high signal low.

```
time := (phsa - 624) #> 0
```



Where did 624 come from?

The number of clock ticks between **phsa~** and **dira[17]~** was determined by replacing the 0.01 μ F capacitor with a 100 pF capacitor and finding the lowest value before zero was returned. In the test program, **time := phsa** replaces **time := (phsa - 624) #> 0**, and the lowest measurable value was 625.

Example Object Measures RC Decay Time

The TestRcDecay object applies the techniques just discussed to measure RC decay in a circuit with variable resistance controlled by the position of a potentiometer’s adjusting knob. As shown in Figure 7-5, the program displays a “working on other tasks” message after starting the RC decay measurement to demonstrate that the counter module automatically increments the **phsa** register until

7: Counter Modules and Circuit Applications Lab

the voltage applied to P17 decays below the Propeller chip's 1.65 V I/O pin threshold. The program can then check back at a later time to find out the value stored in `phsa`.

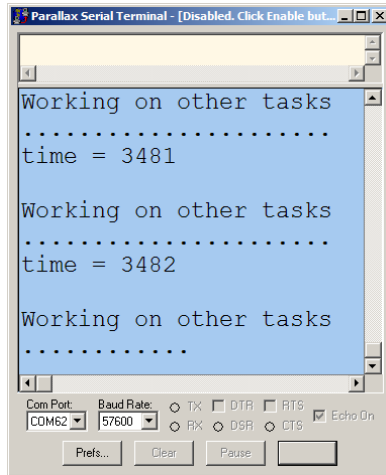

Figure 7-5: RC Decay Times



Please note that the majority of the code examples in this lab are top objects that demonstrate various details and inner workings of counter modules. If you plan on incorporating these concepts into library objects that are designed to be used by other applications, make sure to pay close attention to the section entitled: Probe and Display PWM – Add an Object, Cog and Pair of Counters that begins on page 160.

- ✓ Open the `TestRcDecay.spin` object. It will call methods in `FullDuplexSerialPlus.spin`, so make sure they are both saved in the same folder.
- ✓ Open Parallax Serial Terminal and set its *Com Port* field to the same port the Propeller Tool software uses to load programs into the Propeller chip.
- ✓ Use the Propeller Tool to load `TestRcDecay.spin` into the Propeller chip.
- ✓ Immediately click the Parallax Serial Terminal's *Enable* button. (Don't wait for the program to finish loading. In fact, you can click the Parallax Serial Terminal's *Enable* button immediately after you have pressed F10 or F11 in the Propeller Tool software.)
- ✓ Try adjusting the potentiometer knob to various positions and note the time values. They should vary in proportion to the potentiometer knob's position.

```
.. TestRcDecay.spin
.. Test RC Decay circuit decay measurements.

CON

  _clkmode = xtall1 + pll16x           ' System clock → 80 MHz
  _xinfreq = 5_000_000

  CR = 13

OBJ

  Debug: "FullDuplexSerialPlus"       ' Use with Parallax Serial Terminal to
                                      ' display values

PUB Init

  ' Start serial communication, and wait 2 s for connection to Parallax Serial Terminal.

  Debug.Start(31, 30, 0, 57600)
  waitcnt(clkfreq * 2 + cnt)
```

Counter Modules and Circuit Applications Lab

```
' Configure counter module.

ctra[30..26] := %01000          ' Set mode to "POS detector"
ctra[5..0] := 17                ' Set APIN to 17 (P17)
frqa := 1                       ' Increment phsa by 1 for each clock tick

main                             ' Call the Main method

PUB Main | time
'' Repeatedly takes and displays P17 RC decay measurements.
repeat

  ' Charge RC circuit.

  dira[17] := outa[17] := 1      ' Set pin to output-high
  waitcnt(clkfreq/100_000 + cnt) ' Wait for circuit to charge

  ' Start RC decay measurement. It's automatic after this...

  phsa~                               ' Clear the phsa register
  dira[17]~                             ' Pin to input stops charging circuit

  ' Optional - do other things during the measurement.

  Debug.str(String(CR, CR, "Working on other tasks", CR))
  repeat 22
    Debug.tx(".")
    waitcnt(clkfreq/60 + cnt)

  ' Measurement has been ready for a while. Adjust ticks between phsa~ & dira[17]~.

  time := (phsa - 624) #> 0

  ' Display Result

  Debug.Str(String(13, "time = "))
  Debug.Dec(time)
  waitcnt(clkfreq/2 + cnt)
```

Two Concurrent RC Decay Measurements

Since the counter module keeps track of high time after the decay starts, it is possible to take two concurrent RC decay measurements on different pins. Let's do so with P25 and a light-dependent resistor (abbreviated LDR and also called a photoresistor) instead of a potentiometer. The second measurement will start later than the first since the `phsb~` and `dira[25]~` commands will follow `dira[17]~`. However, the decays can occur in parallel, and while the decays last, the cog continues to execute other commands.

- ✓ Build the circuit shown in Figure 7-6.

Figure 7-6: Second RC Decay Parts and Circuit

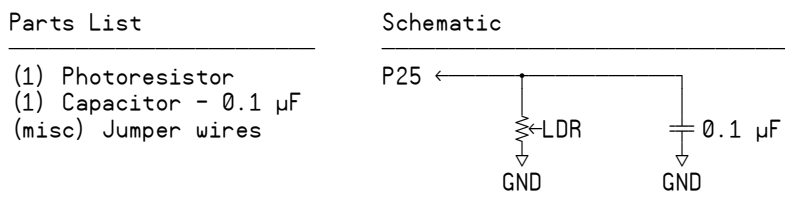

- ✓ Modify a copy of TestRcDecay.spin so that it can measure the circuits from Figure 7-1 and Figure 7-6 concurrently.

Be careful, you'll need to add commands that set the values of `ctrb`, `frqb`, and `phsb`, but the DIR register should be `dira`, not `dirb`. `dirb` is reserved for I/O pins 32..63 in a module with 64 I/O pins. Also, `phsb~` and `dira[25]~` should come immediately after `dira[17]~`.

D/A Conversion – Controlling LED Brightness with DUTY Modes

There are two DUTY mode options, single-ended and differential. A counter module in single-ended DUTY mode allows you to control a signal that can be used for digital to analog conversion with the FRQ register. Although the signal switches rapidly between high and low, the average time it is high (the duty) is determined by the ratio of the FRQ register to 2^{32} .

$$\text{duty} = \frac{\text{pin high time}}{\text{time}} = \frac{\text{FRQ}}{4_294_967_296} \quad \text{Eq. 1}$$

For D/A conversion, let's say the program has to send a 0.825 V signal. That's 25% of 3.3 V, so a 25% duty signal is required. Figuring out the value to store in the FRQ register is simple. Just set `duty = 0.25` and solve for FRQ.

$$0.25 = \frac{\text{FRQ}}{4_294_967_296} \quad \rightarrow \quad \text{FRQ} = 1_073_741_824$$

You can also use Eq. 1 to figure out what duty signal an object is sending. Let's say the value 536,870,912 is stored in a counter module's FRQ register, and its CTR register has it configured to single-ended DUTY mode.

$$\text{duty} = \frac{536_870_912}{4_294_967_296} = 0.125$$

On a 3.3 V scale, that would resolve to 0.375 V. Again, the great thing about counters is that they can do their jobs without tying up a cog. So, the cog will still be free to continue executing commands while the counter takes care of maintaining the D/A conversion duty signal.

How Single-ended DUTY Mode Works

Each time FRQ gets added to PHS, the counter module's phase adder (that adds FRQ to PHS with every clock tick) either sets or clears a carry flag. This carry operation is similar to a carry operation in decimal addition. Let's say you are allowed 3 decimal places, and you try to add two values that add up to more than 999. Some value would normally be carried from the hundreds to the thousands slot. The binary version of addition-with-carry applies when the FRQ register gets added to the PHS register when the result is larger than $2^{32} - 1$. If the result exceeds this value, the PHS adder's carry flag (think of it as the PHS registers "bit 32") gets set.

Counter Modules and Circuit Applications Lab

The interesting thing about this carry flag is that the amount of time it is 1 is proportional to the value stored in the FRQ register divided by 2^{32} . In single-ended DUTY mode, the counter module's phase adder's carry bit controls an I/O pin's output state. Since the time in which the phase adder's carry bit is 1 is proportional to $FRQ/2^{32}$, so is the I/O pin's output state. The I/O pin may rapidly switch between high and low, but the average pin high time is determined by the FRQ-to-232 ratio shown in Eq. 1 above.

Parts and Circuit

Yes, it's back to LEDs for just a little while, and then we'll move on to other circuits. Previous labs used LEDs to indicate I/O pin states and timing. This portion of this lab will use single-ended DUTY mode for D/A conversion to control LED brightness.

Figure 7-7: LED Circuit for Brightness Control with Duty Signals

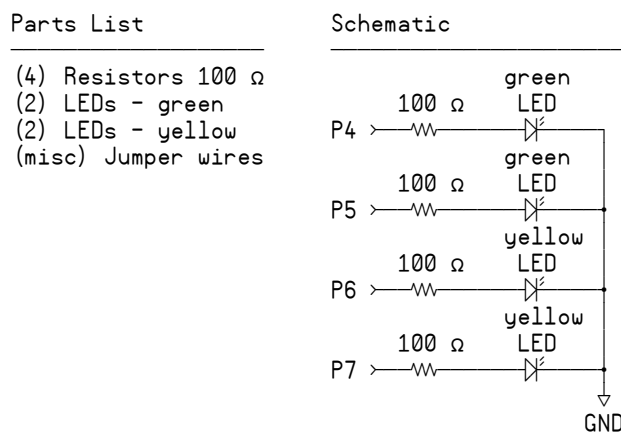

- ✓ Add the circuit shown in Figure 7-7 to your PE Platform, leaving the RC decay circuit in place.

Configuring a Counter for DUTY Mode

Figure 7-8 shows more entries from the CTR object's and Propeller Manual's Counter Mode Table. As mentioned previously, the two types of DUTY modes are single-ended and differential.

With single-ended DUTY mode, the APIN mirrors the state of the phase adder's carry bit. So, if FRQ is set to the 1,073,741,824 value calculated earlier, the APIN will be high $\frac{1}{4}$ of the time. An LED circuit receiving this signal will appear to glow at $\frac{1}{4}$ of its full brightness.

In differential DUTY mode, the APIN signal still matches the phase adder's carry bit, while the BPIN is the opposite value. So whenever the phase adder's carry bit (and APIN) are 1, BPIN is 0, and vice-versa. If FRQ is set to 1,073,741,824, APIN would still cause an LED to glow at $\frac{1}{4}$ brightness while BPIN will glow at $\frac{3}{4}$ brightness.

Figure 7-8: More Excerpts from the CTR.spin's Counter Mode Table

CTRMODE	Description	Accumulate FRQ to PHS	APIN output*	BPIN output*
%00000	Counter disabled (off)	0 (never)	0 (none)	0 (none)
.
%00110	DUTY single-ended	1	PHS-Carry	0
%00111	DUTY differential	1	PHS-Carry	!PHS-Carry
.
%11111	LOGIC always	1	0	0

* must set corresponding DIR bit to affect pin

A¹ = APIN input delayed by 1 clock
 A² = APIN input delayed by 2 clocks
 B¹ = BPIN input delayed by 1 clock

Figure 7-9 is a repeat of Figure 7-4. From Figure 7-8, we know that the value stored in the CTR register's CTRMODE bit field has to be either %00110 (DUTY single-ended) or %00111 (DUTY differential). Then, the APIN (and optionally BPIN) bit fields have to be set to the I/O pins that will transmit the duty signals.

Figure 7-9: CTRA/B Register Map from CTR.spin

bits	31	30..26	25..23	22..15	14..9	8..6	5..0
Name	—	CTRMODE	PLLDIV	—	BPIN	—	APIN

The RC decay application set the FRQ register to 1, and the result was that 1 got added to PHS for every clock tick in which the pin being monitored was high. In this application, the FRQ register gets set to values that control the high time of the duty signal applied to an I/O pin. There is no condition for adding with duty mode; FRQ gets added to PHS every clock tick.

Setting up a Duty Signal

Here are the steps for setting a duty signal either with a counter:

- (1) Set the CTR register's CTRMODE bit field to choose duty mode.
- (2) Set the CTR register's APIN bit field to choose the pin.
- (3) If you are using differential DUTY mode, set the CTR register's BPIN field.
- (4) Set the I/O pin(s) to output.
- (5) Set the FRQ register to a value that gives you the percent duty signal you want.

Counter Modules and Circuit Applications Lab

Example – Send a 25% single-ended duty signal to P4 Using Counter A.

(1) Set the CTR register's CTRMODE bit field to choose a DUTY mode. Remember that bits 30..26 of the CTR register (shown in Figure 7-9) have to be set to the bit pattern selected from the CTRMODE list in Figure 7-8. For example, here's a command that configures the counter module to operate in single-ended DUTY mode:

```
ctra[30..26] := %00110
```

(2) Set the CTR register's APIN bit field to choose the pin. Figure 7-9 indicates that APIN is bits 5..0 in the CTR register. Here's an example that sets the `ctra` register's APIN bits to 4, which will control the green LED connected to P4.

```
ctra[5..0] := 4
```

We'll skip step (3) since the counter module is getting configured to single-ended DUTY mode and move on to:

(4) Set the I/O pin(s) to output.

```
dira[4]~~
```

(5) Set the FRQ register to a value that gives you the duty signal you want. For ¼ brightness, use 25% duty. So, set the `frqa` register to 1_073_741_824 (calculated earlier).

```
frqa := 1_073_741_824
```

Tips for Setting Duty with the FRQ Register

Since the special purpose registers initialize to zero, `frqa` is 0, so 0 is repeatedly added to the PHS register, resulting on no LED state changes. As soon as the program sets the FRQ register to some fraction of 2^{32} , the I/O pin, and the LED, will start sending the duty signal.

Having 2^{32} different LED brightness levels isn't really practical, but 256 different levels will work nicely. One simple way to accomplish that is by declaring a constant that's $2^{32} \div 256$.

```
CON
```

```
scale = 16_777_216          ' 232 ÷ 256
```

Now, the program can multiply the scale constant by a value from 0 to 255 to get 256 different LED brightness levels. Now, if you want ¼ brightness, multiply scale by ¼ of 256:

```
frqa := 64 * scale
```



Time Varying D/A and Filtering: When modulating the value of `frqa` to send time varying signals, an RC circuit typically filters the duty signal. It's better to use a smaller fraction of the useable duty signal range, say 25% to 75% or 12.5% to 87.5%. By keeping the duty in this middle range, the D/A will be less noisy and smaller resistor R and capacitor C values can be used for faster responses. This is especially important for signals that vary quickly, like audio signals, which will be introduced in a different lab.

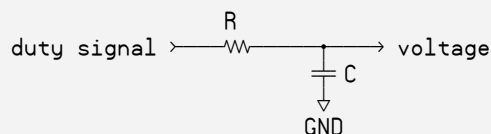

Single-Ended DUTY Mode Code Example

The `LedDutySweep.spin` object demonstrates the steps for configuring a counter single-ended DUTY mode and transmitting a duty signal with an I/O pin. It also sweeps a `duty` variable from 0 to 255 repeatedly, causing the P4 LED to gradually increase in brightness and then turn off.

- ✓ Load the `LedDutySweep` object into the Propeller chip and observe the effect.

```
''LedDutySweep.spin
''Cycle P4 LED from off, gradually brighter, full brightness.

CON

    scale = 16_777_216          ' 232 ÷ 256

PUB TestDuty | pin, duty, mode

    'Configure counter module.

    ctra[30..26] := %00110     ' Set ctra to DUTY mode
    ctra[5..0] := 4            ' Set ctra's APIN
    frqa := duty * scale       ' Set frqa register

    'Use counter to take LED from off to gradually brighter, repeating at 2 Hz.

    dira[4]~~                 ' Set P5 to output

    repeat                    ' Repeat indefinitely
        repeat duty from 0 to 255 ' Sweep duty from 0 to 255
            frqa := duty * scale   ' Update frqa register
            waitcnt(clkfreq/128 + cnt) ' Delay for 1/128th s
```

Duty – Single Ended vs. Differential Modes

Differential is the second option for DUTY mode, as well as several other counter modes. Differential signals are useful for getting signals across longer transmission lines, and are used in wired Ethernet, RS485, and certain audio signals.

When a counter module functions in differential mode, it uses one I/O pin to transmit the same signal that single-ended transmits, along with a second I/O pin that transmits the opposite polarity signal. For example, a counter module set to duty differential mode can send the opposite signal that P4 transmits on P5 or any other I/O pin. Whenever the signal on P4 is high, the signal on P5 is low, and vice versa. Try modifying a copy of `LedDutySweep.spin` so that it sends the differential signal on P5. Then, as the P4 LED gets brighter, the P5 LED will get dimmer. Here are the steps:

- ✓ Save a copy of the `LedDutySweep` object that you will modify.
- ✓ To set the counter module for differential DUTY mode, change `ctr_a[30..26] := %00110` to `ctr_a[30..26] := %00111`.
- ✓ Set the `ctr_a` module's BPIN bit field by adding the command `ctr_a[14..9] := 5`
- ✓ Set P5 to output so that the signal gets transmitted by the I/O pin with the command `dir_a[5]~~`.

Using Both A and B Counter Modules

Using both counter modules to display different LED brightnesses is also a worthwhile exercise. To get two counter modules sending duty signals on separate pins, try these steps:

Counter Modules and Circuit Applications Lab

- ✓ Save another copy of the original, unmodified (single-ended) LedDutySweep object.
- ✓ Add `ctrb[30..26] := %00110`.
- ✓ Assuming `ctrb` will control P6, add `ctrb[5..0] := 6`.
- ✓ Also assuming `ctrb` will control P6, add `dira[6]~~`.
- ✓ In the `repeat` duty from 0 to 255 loop, make `frqb` twice the value of `frqa` with the command `frqb := 2 * frqa`. This will cause the P6 LED to get bright twice as fast as the P4 LED.

Inside DUTY Mode

Let's take a closer look at how this works by examining the 3-bit version. Since the denominator of the fraction is 2 raised to the number of bits in the register, a 3-bit version of FRQ would be divided by $2^3 = 8$:

$$\text{duty} = \frac{\text{pin high time}}{\text{time}} = \frac{\text{frq}}{8} \quad (\text{3-bit example})$$

Let's say the carry bit needs to be high $\frac{3}{8}$ of the time. The 3-bit version of the FRQ register would have to store 3. The example below performs eight additions of 3-bit-FRQ to 3-bit-PHS using long-hand addition. The carry bit (that would get carried into bit-4) is highlighted with the \downarrow symbol whenever it's 1. Notice that out of eight PHS = PHS + FRQ additions, three result in set carry bits. So, the carry bit is in fact set $\frac{3}{8}$ of the time.

carry flag set		\downarrow	\downarrow		\downarrow	\downarrow	\downarrow	\downarrow
		1 1	1 1	1 1		1 1 1	1	1 1 1
3-bit frq	011	011	011	011	011	011	011	011
3-bit phs (previous)	+000	+011	+110	+001	+100	+111	+010	+101
3-bit phs (result)	011	110	001	100	111	010	101	000

i

Binary Addition works just like decimal addition when it's done "long hand". Instead of carrying a digit from 1 to 9 when digits in a particular column add up to a value greater than 9, binary addition carries a 1 if the result in a column exceeds 1.

Binary Result

0 + 0 = 0

0 + 1 = 1

1 + 0 = 1

1 + 1 = 10 (0, carry the 1)

1 + 1 + 1 = 11 (1, carry the 1)

Special Purpose Registers

Each cog has a special purpose register (SPR) array whose elements can be accessed with `spr[index]`. The index value lets you pick a given special purpose register. For example, you can set the value of `ctrb` by assigning a value to `spr[8]`, or `ctrb` by assigning a value to `spr[9]`. Likewise, you can assign values to `frqa` and `frqb` by assigning values to `spr[10]` and `spr[11]`, or `phsa` and `phsb` by assigning values to `spr[12]` and `spr[13]`. A full list of the SPR array elements can be found in the Propeller Manual.

- ✓ Look up SPR in the Spin Language reference section of the Propeller Manual, and review the SPR explanation and table of SPR array elements.

Counter Modules and Circuit Applications Lab

The `LedSweepWithSpr` object does the same job as the `LedDutySweep` code you modified in the “Using Both A and B Counter Modules” section. The difference is that it performs all counter module operations using the SPR array instead of referring to the A and B module’s CTR, FRQ and PHS registers.

- ✓ Compare your copy of `LedDutySweep` that sweeps both counters against the code in `LedSweepWithSpr.spin`.
- ✓ Run `LedSweepWithSpr` and use the LEDs to verify that it controls two separate duty signals.

```
``LedSweepWithSpr.spin
``Cycle P4 and P5 LEDs through off, gradually brighter, brightest at different rates.

CON
    scale = 16_777_216                ' 232 ÷ 256

PUB TestDuty | apin, duty[2], module
    'Configure both counter modules with a repeat loop that indexes SPR elements.
    repeat module from 0 to 1        ' 0 is A module, 1 is B.
        apin := lookupz (module: 4, 6)
        spr[8 + module] := (%00110 << 26) + apin
        dira[apin]~~
    'Repeat duty sweep indefinitely.
    repeat
        repeat duty from 0 to 255    ' Sweep duty from 0 to 255
            duty[1] := duty[0] * 2    ' duty[1] twice as fast
            repeat module from 0 to 1
                spr[10 + module] := duty[module] * scale ' Update frqa register
                waitcnt(clkfreq/128 + cnt)                ' Delay for 1/128th s
```

Modifying `LedSweepWithSpr` for Differential Signals

Try updating the `LedSweepWithSpr` object so that it does two differential signals, one on P4 and P5, and the other on P6 and P7.

- ✓ Make a copy of `LedSweepWithSpr.spin`.
- ✓ Add a `bpin` variable to the `TestDuty` method’s local variable list.
- ✓ Add the command `bpin := lookupz (module: 5, 7)` just below the command that assigns the `apin` value with a `lookup` command.
- ✓ Change `spr[8 + module] := (%00110 << 26) + apin` to `spr[8 + module] := (%00111 << 26) + (bpin << 9) + apin`.
- ✓ Add `dira[bpin]~~` immediately after `dira[apin]~~`.
- ✓ Load the modified copy of `LedSweepWithSpr.spin` into the Propeller chip and verify that it sends two differential duty signals.

Generating Piezospeaker Tones with NCO Mode

NCO stands for *numerically controlled oscillator*. Like DUTY, there are both single-ended and differential NCO modes. If a counter module is configured for single-ended NCO mode, it will make an I/O pin send a square wave. Assuming `clkfreq` remains constant, the frequency of this square wave is “numerically controlled” by a value stored in a given cog’s counter module’s FRQ register.

- ✓ Assemble the parts list and build the schematic shown in Figure 7-10.

Figure 7-10: Audio Range NCO Parts List and Circuits

Parts List	Schematic
(2) Piezospeakers (misc) Jumper wires	Piezospeakers

Counter Module in Single-ended NCO Mode

When configured to single-ended NCO mode, the counter module does two things:

- The FRQ register gets added to the PHS register every clock tick.
- Bit 31 of the PHS register controls the state of an I/O pin.

When bit 31 of the PHS register is 1, the I/O pin it controls sends a high signal, and when it is 0, it sends a low signal. If `clkfreq` remains the same, the fact that FRQ gets added to PHS every clock tick determines the rate at which the PHS register’s bit 31 toggles. This in turn determines the square wave frequency transmitted by the pin controlled by bit 31 of the PHS register.

Given the system clock frequency and an NCO frequency that you want the Propeller to transmit, you can calculate the necessary FRQ register value with this equation:

$$\text{FRQ register} = \text{PHS bit 31 frequency} \times \frac{2^{32}}{\text{clkfreq}} \quad \text{Eq. 2}$$

Example:

What value does `frqa` have to store to make the counter module transmit a 2093 Hz square wave if the system clock is running at 80 MHz? (If this were a sine wave, it would be a C7, a C note in the 7th octave.)

For the solution, start with Eq. 2. Substitute 80,000,000 for `clkfreq` and 2093 for `frequency`.

$$\begin{aligned} \text{frqa} &= 2,093 \times 2^{32} \div 80,000,000 \\ \text{frqa} &= 2,093 \times 53.687 \\ \text{frqa} &= 112,367 \end{aligned}$$

Counter Modules and Circuit Applications Lab

Table 7-1 shows other notes in the 6th octave and their FRQ register values at 80 MHz. The sharp notes are for you to calculate. Keep in mind that these are the square wave versions. In another lab, we'll use objects that digitally synthesize sine waves for truer tones.

Note	Frequency (Hz)	FRQA/B Register	Note	Frequency (Hz)	FRQA/B Register
C6	1046.5	56_184	G6	1568.0	84_181
C6#	1107.8		G6#	1661.2	
D6	1174.7	63_066	A6	1760.0	94_489
D6#	1244.5		A6#	1864.7	
E6	1318.5	70_786	B6	1975.5	105_629
F6	1396.9	74_995	C7	2093.0	112_367
F6#	1480.0				

Eq. 3 can also be rearranged to figure out what frequency gets transmitted by an object given a value the object stores in its FRQ register:

$$\text{PHS bit 31 frequency} = \frac{\text{clkfreq} \times \text{FRQ register}}{2^{32}} \quad \text{Eq. 3}$$

Example:

An object has its cog's Counter B operating in single-ended NCO mode, and it stores 70,786 in its `frqb` register. The system clock runs at 80 MHz. What frequency does it transmit?

We already know the answer from Table 7-1, but here it is with Eq. 3

$$\text{PHS bit 31 frequency} = \frac{80,000,000 \times 70,786}{2^{32}} = 1318 \text{ Hz}$$

Configuring a Counter Module for NCO Mode

Figure 7-11 shows the NCO mode entries in the CTR object's Counter Mode table. Note that it is called NCO/PWM mode in the table, you may see that occasionally. PWM is actually an application of NCO mode that will be explored in the PWM section on page 156. As mentioned, NCO mode has single-ended and differential options. Single-ended NCO mode causes a signal that matches bit 31 of the PHS register to be transmitted by the APIN. Differential NCO mode sends the same signal on APIN along with an inverted version of that signal on BPIN.

Recall that with the DUTY modes, the phase adder's carry flag ("bit 32" of the PHS register) determined the I/O pin's state, which in turn resulted in a duty signal that varied with the value stored by the FRQ register. However, with the NCO modes, it is bit 31 of the PHS register that controls the I/O pin, which results in a square wave whose frequency is determined by the value stored in the FRQ register.

Figure 7-11: NCO Excerpts from the CTR Object’s Counter Mode Table

CTRMODE	Description	Accumulate FRQ to PHS	APIN output*	BPIN output*
%00000	Counter disabled (off)	0 (never)	0 (none)	0 (none)
.
%00100	NCO/PWM single-ended	1	PHS[31]	0
%00101	NCO/PWM differential	1	PHS[31]	!PHS[31]
.
%11111	LOGIC always	1	0	0

* must set corresponding DIR bit to affect pin

A¹ = APIN input delayed by 1 clock
A² = APIN input delayed by 2 clocks
B¹ = BPIN input delayed by 1 clock

The steps for configuring the counter module for the NCO modes are similar to the steps for the DUTY modes. The CTR register’s CTRMODE, APIN (and BPIN in differential mode) bit fields have to be set. Then, the FRQ register gets a value that sets the NCO frequency. As with other output examples, the I/O pins used by the counter module have to be set to output.

Here are the steps for configuring a counter module to NCO mode:

- (1) Configure the CTRA/B register
- (2) Set the FRQA/B register
- (3) Set the I/O pin to output

(1) *Configure the CTRA/B register:* Here is an example that sets Counter A to “NCO single-ended” mode, with the signal transmitted on P27. To do this, set `ctra[30..26]` to %00100, and `ctra[5..0]` to 27.

```
ctra[30..26] := %00100
ctra[5..0] := 27
```

(2) *Set the FRQA/B register:* Here is an example for the square wave version of the C7 note:

```
frqa := 112_367
```

(3) *Set the I/O pin to output:* Since it’s P27 that’s sending the signal, make it an output:

```
dira[27]~~
```

After starting the counter module, it runs independently. The code in the cog can forget about it and do other things, or monitor/control/modify the counter’s behavior as needed.

Square Wave Example

The SquareWaveTest.spin object below plays the square wave version of C in the 7th octave for 1 second.

- Examine the SquareWaveTest object and compare it to steps 1 through 4 just discussed.
- Load the SquareWaveTest object into the Propeller chip. Run it and verify that it plays a tone.
- Change `frqa := 112_367` to `frqa := 224_734`. That'll be C8, the C note in the next higher octave.
- Load the modified object into the Propeller chip. This time, the note should play at a higher pitch.

```
``SquareWaveTest.spin
`` Send 2093 Hz square wave to P27 for 1 s with counter module.

CON

  _clkmode = xtal1 + pll16x          ' Set up clkfreq = 80 MHz.
  _xinfreq = 5_000_000

PUB TestFrequency

  ' Configure ctra module
  ctra[30..26] := %00100           ' Set ctra for "NCO single-ended"
  ctra[5..0] := 27                 ' Set APIN to P27
  frqa := 112_367                  ' Set frqa for 2093 Hz (C7 note) using:
                                   ' FRQA/B = frequency × (232 ÷ clkfreq)

  ' Broadcast the signal for 1 s
  dira[27]~~                       ' Set P27 to output
  waitcnt(clkfreq + cnt)           ' Wait for tone to play for 1 s
```

Stopping (and restarting) the Signal

In the SquareWaveTest object, the cog runs out of commands, so the tone stops because the program ends. In many cases, you will want to stop and restart the signal. The three simplest ways to stop (and resume) signal transmission are:

- 1) **Change the Direction of the I/O pin to input.** In the SquareWaveTest object, this could be done with either `dira[27] := 0` or `dira[27]~` when the program is ready to stop the signal. (To restart the signal, use either `dira[27] := 1` or `dira[27]~~`.)
- 2) **Stop the counter module by clearing CTR bits 30..26.** In the SquareWaveTest object, this can be accomplished with `ctr[30..26] := 0`. Another way to do it is by setting all the bits in the `ctr` register's CTRMODE bitfield to zero with `ctr[30..26]~`. In either case, the I/O pin is still an output, and its output state might be high or low. Later, we'll examine a way to make sure the signal ends when the I/O pin is transmitting a low signal. (To restart the signal, copy `%00100` back into `ctr[30..26]`.)
- 3) **Stop adding to PHS by setting FRQ to 0.** In the SquareWaveTest object, this could be done with either `frqa := 0` or `frqa~`. The counter would keep running, but since it would add zero to `phsa` with each clock tick, bit 31 of `phsa` wouldn't change, so the I/O pin would also stop toggling. Like stopping the counter, the I/O pin would hold whatever output state it had at the instant `frqa` is cleared. (To restart the signal, use `frqa := 112_367`.)

7: Counter Modules and Circuit Applications Lab

The Staccato object toggles the I/O pin between output and input to cause the 2.093 kHz tone to start and stop at 15 Hz for 1 s. It uses approach (1) for stopping and restarting the signal. Your job will be to modify two different copies of the code to use approaches 2 and 3.

- ✓ Load Staccato.spin into the Propeller chip and verify that it chirps at 15 Hz for 1 s.
- ✓ Make two copies of the program.
- ✓ Modify one copy so that it uses approach 2 for starting and stopping the signal.
- ✓ Modify the other copy so that it uses approach 3 for starting and stopping the signal.

```
'' Staccato.spin
'' Send 2093 Hz beeps in rapid succession (15 Hz for 1 s).

CON

  _clkmode = xtall1 + pll116x          ' System clock → 80 MHz
  _xinfreq = 5_000_000

PUB TestFrequency

  ' Configure ctra module
  ctra[30..26] := %00100              ' Set ctra for "NCO single-ended"
  ctra[5..0] := 27                    ' Set APIN to P27
  frqa := 112_367                    ' Set frqa for 2093 Hz (C7 note):

  ' Ten beeps on/off cycles in 1 second.
  repeat 30
    !dira[27]                        ' Set P27 to output
    waitcnt(clkfreq/30 + cnt)        ' Wait for tone to play for 1 s

  ' Program ends, which also stops the counter module.
```



Use F10 and F11 to easily compare programs:

It is convenient to put the original Staccato.spin into the EEPROM with F11, then use F10 when you test your modifications. After running your new program, you can then press and release the PE Platform's reset button to get an instant audio comparison.

Playing a List of Notes

DoReMi.spin is an example where the counter module is used to play a series of notes. Since it isn't needed for anything else in the meantime, the I/O pin that sends the square wave signal to the piezospeaker is set to input during the $\frac{1}{4}$ stops between notes. Bit 31 of the **phsa** register still toggles at a given frequency during the quarter stop, but the pseudo-note doesn't play.

The **frqa** register values are stored in a **DAT** block with the directive:

```
DAT
...
notes long 112_367, 126_127, 141_572, 149_948, 168_363, 188_979, 212_123, 224_734
```

A **repeat** loop that sweeps a variable named **index** from 0 to 7 is used to retrieve and copy each of these notes to the **frqa** register. The loop copies each successive value from the **notes** sequence into the **frqa** register with this command:

```
repeat index from 0 to 7
  ' Set the frequency.
  frqa := long[@notes][index]
...
```

Counter Modules and Circuit Applications Lab

- ✓ Load the DoReMi.spin object into the Propeller chip and observe the effect.

```
''DoReMi.spin
''Play C6, D6, E6, F6, G6, A6, B6, C7 as quarter notes quarter stops between.

CON

_clkmode = xtal1 + pll16x          ' System clock → 80 MHz
_xinfreq = 5_000_000

PUB TestFrequency | index

'Configure ctra module
ctra[30..26] := %00100           ' Set ctra for "NCO single-ended"
ctra[5..0] := 27                 ' Set APIN to P27
frqa := 0                        ' Don't play any notes yet

repeat index from 0 to 7

    frqa := long[@notes][index]  'Set the frequency.

    'Broadcast the signal for 1/4 s
    dira[27]~~
    waitcnt(clkfreq/4 + cnt)      ' Set P27 to output
                                   ' Wait for tone to play for 1/4 s

    dira[27]~
    waitcnt(clkfreq/4 + cnt)      ' 1/4 s stop

DAT
'80 MHz frqa values for square wave musical note approximations with the counter module
'configured to NCO:
'
'      C6      D6      E6      F6      G6      A6      B6      C7
notes long 56_184, 63_066, 70_786, 74_995, 84_181, 94_489, 105_629, 112_528
```

Counter NCO Mode Example with bit 3 Instead of bit 31

In NCO mode, the I/O pin's output state is controlled by bit 31 of the PHS register. However, the on/off frequency for any bit in a variable or register can be calculated using Eq. 4 and assuming a value is repeatedly added to it at a given rate:

$$\text{frequency} = (\text{value} \times \text{rate}) \div 2^{\text{bit} + 1} \quad \text{Eq. 4}$$

Next is an example that can be done on scratch paper that may help clarify how this works.

Bit 3 Example: At what frequency does bit 3 in a variable toggle if you add 4 to it eight times every second? Here, **value** is 4, **rate** is 8 Hz, and **bit** is 3, so

$$\begin{aligned} \text{frequency} &= (\text{value} \times \text{rate}) \div 2^{\text{bit} + 1} \\ &= (4 \times 8 \text{ Hz}) \div 23 + 1 \\ &= 32 \text{ Hz} \div 16 \\ &= 2 \text{ Hz} \end{aligned}$$

Table 7-2 shows how this works. Each 1/8 second, the value 4 gets added to a variable. As a result, bit 3 of the variable gets toggled twice every second, i.e. at 2 Hz.

Table 7-2: Bit 3 Example										
Time (s)	Value	Variable	Bit 3 in Variable							
			7	6	5	4	3	2	1	0
0.000		0	0	0	0	0	0	0	0	0
0.125	4	4	0	0	0	0	0	1	0	0
0.250	4	8	0	0	0	0	1	0	0	0
0.375	4	12	0	0	0	0	1	1	0	0
0.500	4	16	0	0	0	1	0	0	0	0
0.625	4	20	0	0	0	1	0	1	0	0
0.750	4	24	0	0	0	1	1	0	0	0
0.875	4	28	0	0	0	1	1	1	0	0
1.000	4	32	0	0	1	0	0	0	0	0
1.125	4	36	0	0	1	0	0	1	0	0
1.250	4	40	0	0	1	0	1	0	0	0
1.375	4	44	0	0	1	0	1	1	0	0
1.500	4	48	0	0	1	1	0	0	0	0
1.625	4	52	0	0	1	1	0	1	0	0
1.750	4	56	0	0	1	1	1	0	0	0
1.875	4	60	0	0	1	1	1	1	0	0

NCO FRQ Calculator Method

The TerminalFrequencies.spin object below allows you to enter square wave frequencies into Parallax Serial Terminal, and it then calculates and displays the FRQ register value and also plays the tone on the P27 piezospeaker (see Figure 7-12.) The object's NcoFrqReg method is an adaptation of the Propeller Library CTR object's fraction method. Given a square wave frequency, it calculates:

$$\text{frqReg} = \text{frequency} \times (2^{32} \div \text{clkfreq}) \tag{Eq. 5}$$

...and returns frqReg. So, for a given square wave frequency simply set the FRQ register equal to the result returned by the NcoFrqReg method call.

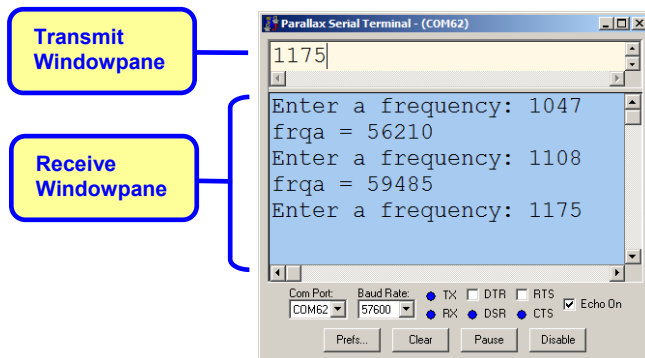

Figure 7-12: Calculating frqa Given a Frequency in Hz

Counter Modules and Circuit Applications Lab

The `NcoFrqReg` method uses a binary calculation approach to come up with the value that was generated by Eq. 5. It would also have been possible to use the `FloatMath` library to perform these calculations. However, the `NcoFrqReg` method takes much less code space than the `FloatMath` library. It also takes less time to complete the calculation, so it makes a good candidate for a counter math object.

- ✓ Use the Propeller Tool to load `TerminalFrequencies.spin` into EEPROM (F11) and immediately click the Parallax Serial Terminal's *Enable* button. (Remember, you don't even have to wait for the program to finish loading.)
- ✓ When prompted, enter the integer portion of each frequency value (not the FRQ register values) from Table 7-1 on page 138 into the Parallax Serial Terminal's Transmit Windowpane, shown in Figure 7-12.
- ✓ Verify that the `NcoFrqReg` method's calculations match the calculated FRQ register values in the table.
- ✓ Remember to click Parallax Serial Terminal's *Disconnect* button before loading the next program.

```
'' TerminalFrequencies.spin
'' Enter frequencies to play on the piezospeaker and display the frq register values
'' with Parallax Serial Terminal.

CON

  _clkmode = xtal1 + pll16x          ' System clock + 80 MHz
  _xinfreq = 5_000_000

  CLS = 16, CR = 13                ' Parallax Serial Terminal control characters

OBJ

  Debug : "FullDuplexSerialPlus"   ' Parallax Serial Terminal display object

PUB Init

  ' Configure ctra module.
  ctra[30..26] := %00100           ' Set ctra for "NCO single-ended"
  ctra[5..0] := 27                 ' Set APIN to P27
  frqa := 0                       ' Don't send a tone yet.
  dira[27]~~                       ' I/O pin to output

  ' Start FullDuplexSerialPlus and clear the Parallax Serial Terminal.
  Debug.start(31, 30, 0, 57600)
  waitcnt(clkfreq * 2 + cnt)
  Debug.tx(CLS)

  Main

PUB Main | frequency, temp

  repeat

    Debug.Str(String("Enter a frequency: "))
    frequency := Debug.getDec
    temp := NcoFrqReg(frequency)
    Debug.Str(String("frqa = "))
    Debug.Dec(temp)
    Debug.tx(CR)
```



```
'Broadcast the signal for 1 s
frqa := temp
waitcnt(clkfreq + cnt)
frqa~

PUB NcoFrqReg(frequency) : frqReg
{{
Returns frqReg = frequency × (232 ÷ clkfreq) calculated with binary long
division. This is faster than the floating point library, and takes less
code space. This method is an adaptation of the CTR object's fraction
method.
}}

repeat 33
  frqReg <<= 1
  if frequency => clkfreq
    frequency -= clkfreq
    frqReg++
  frequency <<= 1
```

Use Two Counter Modules to Play Two Notes

The TwoTones object demonstrates how both counters can be used to play two different square wave tones on separate speakers. In this example, all the program does is wait for certain amounts of time to pass before adjusting the `frqa` and `frqb` register values. The program could also perform a number of other tasks before coming back and waiting for the CLK register to get to the next time increment.

- ✓ Load the TwoTones.spin object into the Propeller chip.
- ✓ Verify that it plays the square wave approximation of C6 on the P27 piezospeaker for 1 s, then pauses for ½ s, then plays E6 on the P2 piezospeaker, then pauses for another ½ s, then plays both notes on both speakers at the same time.

```
''TwoTones.spin
''Play individual notes with each piezospeaker, then play notes with both at the
''same time.

CON

  _clkmode = xtall1 + pll16x          ' System clock → 80 MHz
  _xinfreq = 5_000_000

OBJ

  SqrWave : "SquareWave"

PUB PlayTones | index, pin, duration

  'Initialize counter modules
  repeat index from 0 to 1
    pin := byte[@pins][index]
    spr[8 + index] := (%00100 << 26) + pin
    dira[pin]~~

  'Look up tones and durations in DAT section and play them.
  repeat index from 0 to 4
    frqa := SqrWave.NcoFrqReg(word[@Anotes][index])
    frqb := SqrWave.NcoFrqReg(word[@Bnotes][index])
    duration := clkfreq/(byte[@durations][index])
    waitcnt(duration + cnt)
```

Counter Modules and Circuit Applications Lab

```
DAT
pins      byte 27, 3

`index    0      1      2      3      4
durations byte 1,   2,   1,   2,   1
anotes    word 1047, 0,   0,   0,   1047
bnotes    word 0,   0,   1319, 0,   1319
```

Inside TwoTones.spin

The TwoTones object declares the SquareWave object (see Appendix A) in its **OBJ** block and gives it the nickname `SqrWave`. This object has a method with the same name and function as `NcoFrqReg` in the TerminalFrequencies object, but the coding relies on methods adapted from the Propeller Library's `CTR` object to perform the calculation.

The first **repeat** loop in the `PlayTones` method initializes the counter method by setting `spr` array elements 8 and 9, which are the `ctra` and `ctrb` registers. The `index` variable in that loop is also used to look up the pin numbers listed in the `DAT` block's `Pins` sequence using `pin := byte[@pin][index]`. The second **repeat** loop looks up elements in the `DAT` block's `durations`, `anotes` and `bnotes` sequences. Each sequence has five elements, so the **repeat** loop indexes from 0 to 4 to fetch each element in each sequence.

Take a look at the command `frqa := SquareWave.NcoFrqReg(word[@anotes][index])` in the TwoTones object's second **repeat** loop. First, `word[@anotes][index]` returns the value that's `index` elements to the right of the `anotes` label. The first time through the loop, `index` is 0, so it returns 1047. The second, third and fourth time through the loop, `index` is 1, then 2, then 3. It returns 0 each time. The fifth time through the loop, `index` is 4, so it returns 1047 again. Each of these values returned by `word[@anotes][index]` becomes a parameter in the `SquareWave.NcoFrqReg` method call. Finally, the value returned by `SquareWave.NcoFrqReg` gets stored in the `frqa` variable. The result? A given frequency value in the `anotes` sequence gets converted to the correct value for `frqa` to make the counter module play the note.

Counter Control with an Object

If you examined the `SquareWave` object, you may have noticed that has a `Freq` method that allows you to choose a counter module (0 or 1 for Counter A or Counter B), a pin, and a frequency. The `Freq` method considerably simplifies the TwoTones object.

- ✓ Compare `TwoTonesWithSquareWave` (below) against the `TwoTones` object (above).
- ✓ Load `TwoTonesWithSquareWave` into the Propeller chip and verify that it behaves the same as the `TwoTones` object.

```
``TwoTonesWithSquareWave.spin
``Play individual notes with each piezospeaker, then play notes with both at the
``same time.

CON

  _clkmode = xtal1 + pll16x          ' System clock → 80 MHz
  _xinfreq = 5_000_000

OBJ

  SqrWave : "SquareWave"
```

```
PUB PlayTones | index, pin, duration

'Look tones and durations in DAT section and play them.
repeat index from 0 to 4
  SqrWave.Freq(0, 27, word[@Anotes][index])
  SqrWave.Freq(1, 3, word[@Bnotes][index])
  duration := clkfreq/(byte[@durations][index])
  waitcnt(duration + cnt)

DAT
pins      byte 27, 3

'index    0      1      2      3      4
durations byte 1,  2,  1,  2,  1
anotes    word 1047, 0,  0,  0,  1047
bnotes    word 0,  0,  1319, 0,  1319
```

Applications – IR Object and Distance Detection with NCO and DUTY Modes

When you point your remote at the TV and press a button, the remote flashes an IR LED on/off rapidly to send messages to the IR receiver in the TV. The rate at which the IR LED flashes on/off is matched to a filter inside the TV's IR receiver. Common frequencies are 36.7, 38, 40, and 56.9 kHz. This frequency-and-filter system is used to distinguish IR remote messages from ambient IR such as sunlight and the 120 Hz signal that is broadcast by household lighting.



The wavelength of IR used by remotes is typically in the 800 to 940 nm range.

The remote transmits the information by modulating the IR signal. The amount of time the IR signal is sent can contain information, such as start of message, binary 1, binary 0, etc. By transmitting sequences of signal on/off time, messages for the various buttons on your remote can be completed in just a few milliseconds.

The IR LED and receiver that are used for beaming messages to entertainment system components can also be used for object detection. In this scheme, the IR LED and IR receiver are placed so that the IR LED's light will bounce off an object and return to the IR receiver. The IR LED still has to modulate its light for the IR receiver's pass frequency. If the IR LED's light does reflect off an object and return to the IR receiver, the receiver sends a signal indicating that it is receiving the IR signal. If the IR does not reflect off the object and return to the IR receiver, it sends a signal indicating that it is not receiving IR.



This detection scheme uses very inexpensive parts, and has become increasingly popular in hobby robotics.

The PE Kit's IR receiver shown on the right side of Figure 7-13 has a 38 kHz filter. A Propeller chip cog's counter module can be used to generate the 38 kHz signal for the IR LED to broadcast for either IR object detection or entertainment system component control. This section of the lab will simply test object detection, but the same principles will apply to remote decoding and entertainment system component control.

- ✓ Build the circuit shown in Figure 7-13 – Figure 7-15, using the photo as a parts placement guide.

Figure 7-13: IR Detection Parts and Schematic

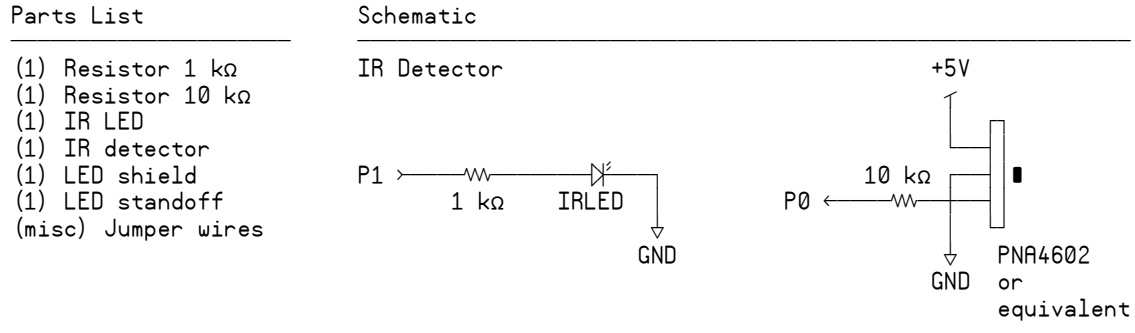

Figure 7-14 shows how to assemble the IR LED for object detection. First, snap the IR LED into the LED standoff. Then, attach the light shield to the standoff.

Figure 7-14: IR LED Assembly



A breadboard arrangement that works well for the IR LED and receiver is shown in Figure 7-15. Notice how the IR receiver's 5 V source is jumpered from the center breadboard's socket (K, 3) to the left breadboard's socket (G, 1). The IR receiver's ground is jumpered from the center breadboard's socket (K, 4) to the left breadboard's (G, 2) socket. The IR LED's shorter cathode pin is connected to the left vertical ground rail (BLACK, 4). A 1 kΩ resistor is in series between the IR LED's anode and P1. A large resistor is important for connecting a 5 V output device to the Propeller chip's 3.3 V input; a 10 kΩ resistor is used between the IR receiver's 5 V output and the Propeller chip's P0 I/O pin. A 1 to 2 kΩ resistor is useful in series with the IR LED to reduce the detection range. A small resistor like 100 Ω can cause phantom detections of far away objects, such as the ceiling.

Figure 7-15: IR LED and Detector Orientation

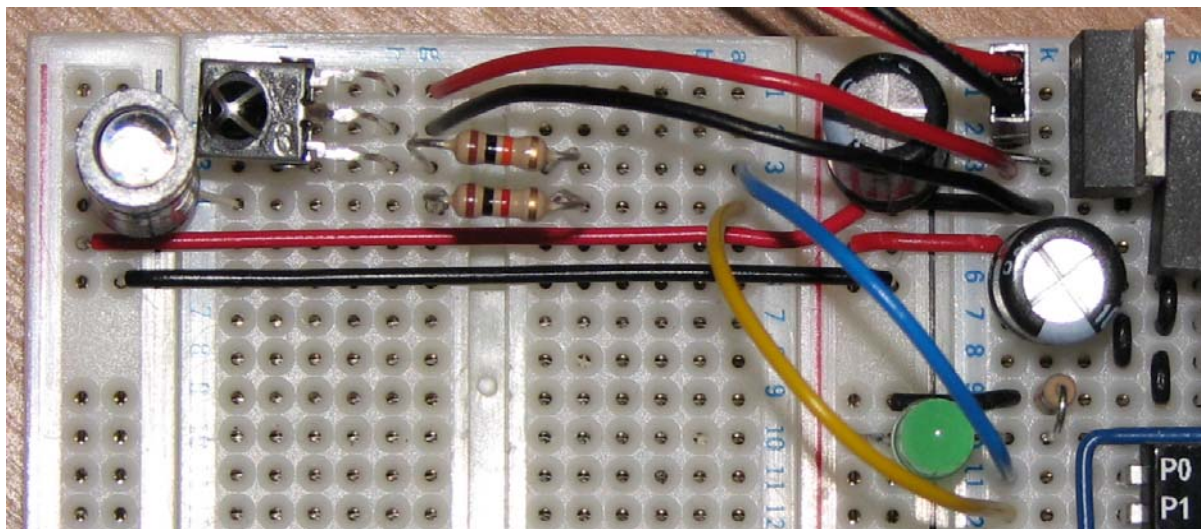

IR Object Detection with NCO

The IrObjectDetection object sets up the 38 kHz signal using NCO mode. Whenever the I/O pin connected to the IR LED is set to output, the 38 kHz transmits. In a **repeat** loop, the program allows the IR LED to transmit the 38 kHz infrared signal for 1 ms, then it saves `ina[0]` in a variable named `state` and displays it on Parallax Serial Terminal (Figure 7-16).

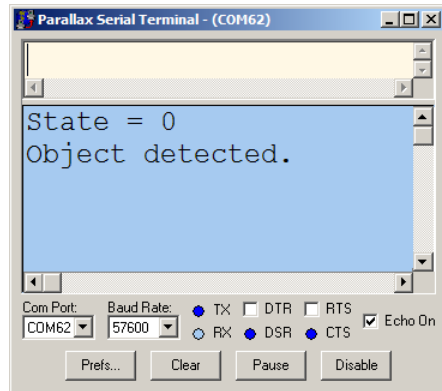

Figure 7-16: Object Detection Display

- ✓ Use the Propeller Tool to load IrObjectDetection.spin into EEPROM (F11) and immediately click the Parallax Serial Terminal's *Enable* button.
- ✓ The state should be 1 with no obstacles visible, or 0 when you place your hand in front of the IR LED/receiver.

```

'' IrObjectDetection.spin
'' Detect objects with IR LED and receiver and display with Parallax Serial Terminal.

CON

  _clkmode = xtal1 + pll16x          ' System clock → 80 MHz
  _xinfreq = 5_000_000

  ' Constants for Parallax Serial Terminal.
  HOME = 1, CR = 13, CLS = 16, CRSRX = 14, CLREOL = 11

OBJ

  Debug      : "FullDuplexSerialPlus"
  SqrWave    : "SquareWave"

PUB IrDetect | state

  ' Start 38 kHz square wave
  SqrWave.Freq(0, 1, 38000)          ' 38 kHz signal → P1
  dira[1]~                          ' Set I/O pin to input when no signal needed

  ' Start FullDuplexSerialPlus
  Debug.start(31, 30, 0, 57600)      ' Start FullDuplexSerialPlus
  waitcnt(clkfreq * 2 + cnt)         ' Give user time to click Enable.
  Debug.tx(CLS)                      ' Clear screen

repeat

  ' Detect object.
  dira[1]~                          ' I/O pin → output to transmit 38 kHz
  waitcnt(clkfreq/1000 + cnt)        ' Wait 1 ms
  state := ina[0]                   ' Store I/R detector output
  dira[1]~                          ' I/O pin → input to stop signal
  
```

```

` Display detection (0 detected, 1 not detected)
Debug.str(String(HOME, "State = "))
Debug.Dec(state)
Debug.str(String(CR, "Object "))
if state == 1
    Debug.str(String("not "))
Debug.str(String("detected.", CLREOL))
waitcnt(clkfreq/10 + cnt)
    
```

IR Distance Detection with NCO and Duty Sweep

If the IR LED shines more brightly, it makes the detector more far-sighted. If it shines less brightly, it makes it more near-sighted. Recall that a counter module's DUTY mode can be used to control LED brightness and even sweep the LED's brightness from dim to bright (see page 129.) This same duty sweep approach can be combined with the NCO signal from the IR object detection example to make the IR LED flash on/off at 38 kHz, sweeping from dim to bright. With each increase in brightness, the IR detector's output can be rechecked in a loop. The number of times the IR detector reported that it detected an object will then be related to the object's distance from the IR LED/detector.

Although the circuit from Figure 7-13 can be used for distance detection with a combination of NCO and duty signals, the circuit in Figure 7-17 makes it possible to get better results from the IR receiver. Instead of tying the IR LED's cathode to GND, it is connected to P2. The program can then sweep the voltage applied to IR LED's cathode from 0 to 3.3 V via P2 while the signal from P1 transmits the 38 kHz NCO signal to the anode end of the circuit. Since an LED is a 1-way valve, the low portion of the 38 kHz signal does not get transmitted since it is less than the DC voltage that the duty signal synthesizes on P2. During the high portions of the 38 kHz signal, the increased voltages applied to P2 reduce the voltage across the LED circuit, which in turn reduces its brightness. So, it's the same 38 kHz signal, just successively less bright.

Figure 7-17: IR Detection Parts and Schematic

Parts List	Schematic
(1) Resistor 100 Ω (1) Resistor 10 k Ω (1) IR LED (1) IR detector (1) LED shield (1) LED standoff (misc) Jumper wires	

The `IrDetector.spin` object below performs the distance detection just discussed. The parent object has to call the `init` method to tell it which pins are connected to the IR LED circuit's anode and cathode ends and the IR receiver's outputs. When the `distance` method gets called, it uses the duty sweep approach just discussed and the pin numbers that were passed to the `init` method to measure the object's distance.

The `IrDetector` object's `distance` method uses the `SquareWave` object to start transmitting the 38 kHz signal to the IR LED circuit's anode end using Counter B. Then, it configures Counter A to single-ended DUTY mode and initializes `frqa` and `phsa` to 0, which results in an initial low signal to the IR

7: Counter Modules and Circuit Applications Lab

LED circuit's cathode end. Next, a **repeat** loop very rapidly sweeps `duty` from 0/256 to 255/256. With each iteration, the voltage to the IR LED circuit's cathode increases, making the IR LED less bright and the IR detector more nearsighted. Between each `duty` increment, the loop adds the IR receiver's output to the `dist` return value. Since the IR receiver's output is high when it doesn't see reflected IR, `dist` stores the number of times out of 256 that it did not see an object. When the object is closer, this number will be smaller; when it's further, the number will be larger. So, after the loop, the method's return value `dist` contains a representation of the object's distance.



Keep in mind that this distance measurement will vary with the surface reflecting the IR.

For example, if the distance method returns 175, the measured distance for a white sheet of paper might be five times the distance of a sheet of black vinyl. Reason being, the white paper readily reflects infrared, so it will be visible to the receiver much further away. In contrast, black vinyl tends to absorb it, and is only visible at very close ranges.

```
'' IrDetector.spin
CON
    scale = 16_777_216          ' 232 ÷ 256
OBJ
    SquareWave : "SquareWave"  ' Import square wave cog object
VAR
    long anode, cathode, recPin, dMax, duty
PUB init(irLedAnode, irLedCathode, irReceiverPin)
    anode := irLedAnode
    cathode := irLedCathode
    recPin := irReceiverPin
PUB distance : dist
    {{
    Performs a duty sweep response test on the IR LED/receiver and returns dist, a zone value
    from 0 (closest) to 256 (no object detected).
    }}
    ' Start 38 kHz signal.
    SquareWave.Freq(1, anode, 38000)          ' ctrb 38 kHz
    dira[anode]~~
    ' Configure Duty signal.
    ctra[30..26] := %00110                    ' Set ctra to DUTY mode
    ctra[5..0] := cathode                     ' Set ctra's APIN
    frqa := phsa := 0                         ' Set frqa register
    dira[cathode]~~                           ' Set P5 to output
    dist := 0
    repeat duty from 0 to 255                  ' Sweep duty from 0 to 255
        frqa := duty * scale                  ' Update frqa register
        waitcnt(clkfreq/128000 + cnt)        ' Delay for 1/128th s
        dist += ina[recPin]                  ' Object not detected? Add 1 to dist.
```

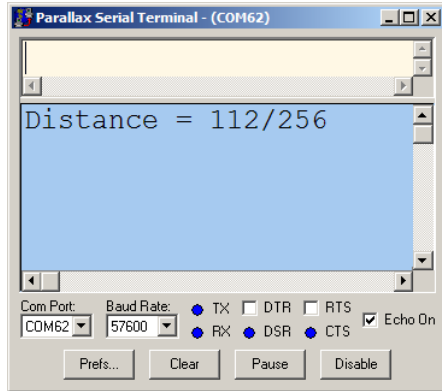

Figure 7-18: Distance Detection Display

The TestIrDutyDistanceDetector object gets distance measurements from the IrDetector object and displays them in Parallax Serial Terminal (Figure 7-18). With the 100 Ω resistor in series with the IR LED, whether or not the system detects your ceiling from table height depends on how high and how reflective your ceiling is and how sensitive your particular detector is. If the system detects no object, it will return 256. Daylight streaming in through nearby windows may introduce some noise in the detector's output, resulting in values slightly less than 256 when no object is detected. As a target object is brought closer to the IR LED/receiver, the measurements will decrease, but not typically to zero unless the IR LED is pointed directly into the IR receiver's phototransistor (the black bubble under the crosshairs).

- ✓ Make sure IrDetector.spin is saved to the same folder as TestIrDutyDistanceDetector.spin and FullDuplexSerialPlus.spin.
- ✓ Use the Propeller Tool to load TestIrDutyDistanceDetector.spin into EEPROM (F11) and immediately click the Parallax Serial Terminal's *Enable* button.
- ✓ Experiment with a variety of targets and distance tests to get an idea of what such a system might and might not be useful for.

```
'' TestIrDutyDistanceDetector.spin
'' Test distance detection with IrDetector object.

CON

  _xinfreq = 5_000_000
  _clkmode = xtal1 + pll16x

  CLS = 16, CRSRX = 14, CLREOL = 11

OBJ

  ir      : "IrDetector"
  debug   : "FullDuplexSerialPlus"

PUB TestIr | dist

  'Start serial communication, and wait 2 s for Parallax Serial Terminal connection.

  debug.Start(31, 30, 0, 57600)
  waitcnt(clkfreq * 2 + cnt)
  debug.tx(CLS)
  debug.str(string("Distance = "))
  'Configure IR detectors.
  ir.init(1, 2, 0)
```



```
repeat
  Get and display distance.
  debug.str(string(CRSRX, 11))
  dist := ir.Distance
  debug.dec(dist)
  debug.str(string("/256", CLREOL))
  waitcnt(clkfreq/3 + cnt)
```

Counting Transitions with POSEDGE and NEGEDGE Modes

Counter modules also have positive and negative edge detection modes (see Figure 7-19). In POSEDGE mode, a counter module will add FRQ to PHS when it detects a transition from low to high on a given I/O pin. NEGEDGE mode makes the addition when it detects a high to low transition. Either can be used for counting the cycles of signals that pass above and then back down below a Propeller I/O pin's 1.65 V logic threshold. (Be aware that just like POS, both POSEDGE and NEGEDGE modes have "with feedback" options though they are not shown in our excerpt of the Counter Mode Table in Figure 7-19.)



Input or output? These counter modes can be used to either count the transitions of a signal applied to the I/O pin or the transitions of a signal the I/O pin is transmitting.

Figure 7-19: Edge Detector Excerpts from the CTR Object's Counter Mode Table

CTRMODE	Description	Accumulate FRQ to PHS	APIN output*	BPIN output*
%00000	Counter disabled (off)	0 (never)	0 (none)	0 (none)
.
%01010	POSEDGE detector	A^1 & $!A^2$	0	0
.
%01110	NEGEDGE detector	$!A^1$ & A^2	0	0
.
%11111	LOGIC always	1	0	0

* must set corresponding DIR bit to affect pin

A^1 = APIN input delayed by 1 clock
 A^2 = APIN input delayed by 2 clocks
 B^1 = BPIN input delayed by 1 clock

Notice from the notes in the Counter Mode Table excerpt in Figure 7-19 that the addition of FRQ to PHS occurs one clock cycle after the edge. This could make a difference in some assembly language programs where the timing is tight, but does not have any significant impact on interpreted Spin language programs.

The steps for setting up a counter still involve setting the CTR register's CTRMODE bit field (bits 30..26) and its APIN bit field (bits 5..0) along with setting the FRQ register to the value that should be added to the PHS register when an edge is detected. Before the measurement, they can be set to zero.

Counter Modules and Circuit Applications Lab

```
ctrb[30..26] := %01110
ctrb[5..0] := 27
frqb~
phsb~
```

Here's an example from the next program that demonstrates one way of using NEGEDGE detector mode to control the duration of a tone played on the piezospeaker. The Counter A module is set to transmit a 2 kHz square wave with single-ended NCO mode on the same I/O pin that the Counter B register will monitor with NEGEDGE detector mode. The `frqb` register is set to 1, so that with each negative clock edge, 1 gets added to `frqb`. To play a 2 kHz tone for 1 second, it takes 2000 cycles. The `repeat while phsb < 2000` command only allows the program to move on and clear `frqa` to stop playing the tone after 2000 negative edges have been detected.

```
frqb := 1
frqa := SquareWave.NcoFrqReg(2000)

repeat while phsb < 2000

frqa~
```



Polling: This example polls the `phsb` register, waiting for the number of transitions to exceed a certain value, but it doesn't necessarily need to poll for the entire 2000 cycles. This will free up the cog to get a few things done while the signal is transmitting and check periodically to find out how close `phsb` is to 2000.

- ✓ Load `CountEdgeTest.spin` into the Propeller chip and verify that counting edges can be used to control the duration of the tone.

```
{{
CountEdgeTest.spin
Transmit NCO signal with Counter A
Use Counter B to keep track of the signal's negative edges and stop the signal
after 2000.
}}

CON

  _clkmode = xtal1 + pll16x           'System clock → 80 MHz
  _xinfreq = 5_000_000

OBJ

  SqrWave      : "SquareWave"

PUB TestFrequency

  ' Configure counter modules.

  ctra[30..26] := %00100           'ctr module to NCO mode
  ctra[5..0] := 27

  ctrb[30..26] := %01110           'ctrb module to NEGEDGE detector
  ctrb[5..0] := 27
  frqb~
  phsb~

  ' Transmit signal for 2000 NCO signal cycles

  outa[27]~
  dira[27]~~           ' P27 → output-low
```

```

frqb := 1                                ' Start the signal
frqa := SqrWave.NcoFreqReg(2000)

repeat while phsb < 2000                  ' Wait for 2 k reps
frqa~                                     ' Stop the signal

```

Faster Edge Detection

The next example program can stop frequencies up to about 43.9 kHz on the falling clock edge. For controlling the number of pulses delivered by faster signals, an assembly language program will be way more responsive, and can likely detect the falling edge and stop it within a few clock cycles.

BetterCountEdges.spin monitors a 3 kHz signal transmitted by Counter A. Instead of monitoring negative edges, it configures Counter B to monitor positive edges on P27 with `ctrb[30..26] := 01010` and `ctrb[5..0] := 27`. Next, it sets `frqb` to 1 so that 1 gets added to the PHS register with each positive edge. Instead of clearing the PHS register and waiting for 3000 positive edges, it sets `phsb` to -3000. Next, it sets bit 27 in a variable named `a` to 1 with the command `a |< 27`.

- ✓ Look up the bitwise decode `|<` operator in the Propeller Manual.

When the `frqa := SquareWave.CalcFreqReg(3000)` command executes, P27 starts sending a 3 kHz square wave. Since `phsb` is bit-addressable, the command `repeat while phsb[31]` repeats while bit 31 of the `phsb` register is 1. Recall that the highest bit of a variable or register will be 1 so long as the value is negative. So `phsb[31]` will be 1 (non zero) while `phsb` is negative. The `phsb` register will remain negative until `frqb = 1` is added to `phsb` 3000 times.

When the `repeat` loop terminates, the signal is high because it was looking for a positive edge. The goal is to stop the signal after it goes low. The command `waitpeq(0, a, 0)` waits until P27 is zero. The command `waitpeq(0, |< 27, 0)` could also have been used, but the program wouldn't respond as quickly because it would have to first calculate `|< 27`; whereas `waitpeq(0, a, 0)` already has that value calculated and stored in the `a` variable. So the `waitpeq` command allows the program to continue to `frqa~`, which clears the `frqa` register, and stops the signal at output-low after the 3000th cycle.

- ✓ Look up and read about `waitpeq` in the Propeller Manual.
- ✓ Load BetterCountEdges.spin into the Propeller chip and verify that it plays the 3 kHz signal for 1 s.
- ✓ If you have an oscilloscope, set the signal for ten cycles instead of 3000. Then, try increasing the frequency, and look for the maximum frequency that will still deliver only 10 cycles.

```

'' BetterCountEdges.spin
CON
    _clkmode = xtal1 + pll16x                ' System clock → 80 MHz
    _xinfreq = 5_000_000

OBJ
    SquareWave : "SquareWave"

PUB TestFrequency | a, b, c
    ' Configure counter modules.

```

```
ctra[30..26] := %00100           'ctra module to NCO mode
ctra[5..0] := 27                 'P27 → output-low
outa[27]~
dira[27]~~

ctrb[30..26] := %01010         'ctrb module to POSEDGE detector
ctrb[5..0] := 27
frqb := 1                       'Add 1 for each cycle
phsb := -3000                   'Start the count at -3000

a := |< 27                      'Set up a pin mask for the waitpeq command

frqa := SquareWave.NcoFrqReg(3000) 'Start the square wave
repeat while phsb[31]           'Wait for 3000th low→high transition
waitpeq(0, a, 0)               'Wait for low signal
frqa~                           'Stop the signal
```

PWM with the NCO Modes

PWM stands for pulse width modulation, which can be useful for both servo and motor control. A counter module operating in NCO mode can be used to generate precise duration pulses, and a **repeat** loop with a **waitcnt** command can be used to maintain the signal's cycle time.

Let's first take a look at sending a single pulse with a counter module. This very precise method is good down to the duration of a Propeller chip's system clock tick. After setting up the counter in NCO mode, simply set the PHS register to the duration you want the pulse to last by loading it with a negative value. For example, the command **phsa := -clkfreq** in the next example program sets the **phsa** register to -80,000,000. Remember that bit 31 of a register will be 1 so long as it's negative, and also remember that in NCO mode bit 31 of the PHS register controls an I/O pin's output state. So, when the PHS register is set to a negative value (and FRQ to 1), the I/O pin will send a high signal for the same number of clock ticks as the negative number stored in PHS.

- ✓ The example programs in this PWM section will send signals to the LED circuits in Figure 7-7 on page 130. If you removed the circuit from in Figure 7-7 on page 130 from your board, rebuild it now.

Sending a Single Pulse

The SinglePulseWithCounter object uses this technique to send a 1 second pulse to the LED on P4. Even though the program can move on as soon as it has set the PHS register to **-clkfreq**, it can't ignore the PHS register indefinitely. Why? Because, $2^{31} - 1 = 2,147,483,647$ clock ticks later, the PHS register will roll over from a large positive number to a large negative number and start counting down again. Since bit 31 of the PHS register will change from 0 to 1 at that point, the I/O pin will transition from low to high for no apparent reason.

- ✓ Load SinglePulseWithCounter.spin into the Propeller chip and verify that it sends a 1 second pulse. This pulse will last exactly 80,000,000 clock ticks.
- ✓ With the Propeller chip's clock running at 80 MHz, the pin will go high again about 26.84 seconds later. Verify this with a calculator and by waiting 27 seconds after the 1 s high signal ended.
- ✓ If you have an oscilloscope, try setting the PHS register to -1 and see if you can detect the 12.5 ns pulse the propeller I/O pin transmits. Also try setting **phsa** to **clkfrq/1_000_000** for a 1 μs pulse.

```
''SinglePulseWithCounter.spin
''Send a high pulse to the P4 LED that lasts exactly 80_000_000 clock ticks.

CON

  _clkmode = xtal1 + pll16x          ' System clock → 80 MHz
  _xinfreq = 5_000_000

PUB TestPwm | tc, tHa, tHb, ti, t

  ctra[30..26] := %00100          ' Configure Counter A to NCO
  ctra[5..0] := 4
  frqa := 1
  dira[4]~~

  phsa := - clkfreq              ' Send the pulse

  ' Keep the program running so the pulse has time to finish.
  repeat
```

Pulse Width Modulation

For a repeating PWM signal, the program has to establish the cycle time using `waitcnt`. Then, the pulse duration is determined each time through the loop by setting the PHS register to a negative value at the beginning of the cycle.

The `1Hz25PercentDutyCycle.spin` object blinks the P4 LED every second for 0.25 seconds. The `repeat` loop repeats once every second, and the counter sends a high signal to the P4 LED for $\frac{1}{4}$ s with each repetition. The command `tC := clkfreq` sets the variable that holds the cycle time to the number of clock ticks in one second. The command `tHa := clkfreq/4` sets the high time for the A counter module to $\frac{1}{4}$ s. The command `t := cnt` records the `cnt` register at an initial time.

Next, a `repeat` loop manages the pulse train. It starts by setting `phsa` equal to `-tHa`, which starts the pulse that will last exactly `clkfreq/4` ticks. Then, it adds `tC`, the cycle time of `clkfreq` ticks, to `t`, the target time for the next cycle to start. The `waitcnt(t)` command waits for the number of ticks in 1 s before repeating the loop.

- ✓ Run the program and verify the $\frac{1}{4}$ s high time signal every 1 s with the LED connected to P4.
- ✓ If you have an oscilloscope, try a signal that lasts 1.5 ms, repeated every 20 ms. This would be good to make a servo hold its center position.

```
''1Hz25PercentDutyCycle.spin
''Send 1 Hz signal at 25 % duty cycle to P4 LED.

CON

  _clkmode = xtal1 + pll16x          ' System clock → 80 MHz
  _xinfreq = 5_000_000

PUB TestPwm | tc, tHa, t

  ctra[30..26] := %00100          ' Configure Counter A to NCO
  ctra[5..0] := 4
  frqa := 1
  dira[4]~~

  tC := clkfreq                    ' Set up cycle and high times
  tHa := clkfreq/4
  t := cnt                          ' Mark counter time
```

Counter Modules and Circuit Applications Lab

```
repeat                                ' Repeat PWM signal
  phsa := -tHa                         ' Set up the pulse
  t += tC                              ' Calculate next cycle repeat
  waitcnt(t)                          ' Wait for next cycle
```

This is another good place to examine differential signals. The only differences between this example program and the previous one are:

- The mode is set to NCO differential using `ctra[30..26] := %00101` (differential) instead of `ctra[30..26] := %00100` (single-ended)
 - A second I/O pin is selected for differential signals with `ctra[14..9] := 5`
 - Both P4 and P5 are set to output with `dira[4..5]~~` instead of just `dira[4]~~`
- ✓ Try the program and verify that P5 is on whenever P4 is off.

```
'' 1Hz25PercentDutyCycleDiffSig.spin
'' Differential version of 1Hz25PercentDutyCycle.spin

CON

  _clkmode = xtal1 + pll16x           ' clock → 80 MHz
  _xinfreq = 5_000_000

PUB TestPwm | tc, tHa, t

  ctra[30..26] := %00101             ' Counter A → NCO (differential)
  ctra[5..0] := 4                    ' Select I/O pins
  ctra[14..9] := 5
  frqa := 1                          ' Add 1 to phs with each clock tick

  dira[4..5]~~                       ' Set both differential pins to output

  ' The rest is the same as 1Hz25PercentDutyCycle.spin

  tC := clkfreq                      ' Set up cycle and high times
  tHa := clkfreq/4
  t := cnt                            ' Mark counter time

  repeat                              ' Repeat PWM signal
    phsa := -tHa                     ' Set up the pulse
    t += tC                           ' Calculate next cycle repeat
    waitcnt(t)                       ' Wait for next cycle
```

The TestDualPwm.spin object uses both counters to transmit PWM signals that have the same cycle time but independent high times (1/2 s high time with Counter A and 1/5 s with Counter B). The duty cycle signals are transmitted on P4 and P6.

- ✓ Try making both signals differential, using I/O pins P4..P7.
- ✓ Again, if you have an oscilloscope, try making one signal 1.3 ms and the other 1.7 ms. This could cause a robot with two continuous rotation drive servos to either go straight forward or straight backwards.

7: Counter Modules and Circuit Applications Lab

```
{ {
TestDualPWM.spin
Demonstrates using two counter modules to send a dual PWM signal.
The cycle time is the same for both signals, but the high times are independent of
each other.
} }

CON

  _clkmode = xtall + pll16x          ' System clock → 80 MHz
  _xinfreq = 5_000_000

PUB TestPwm | tc, tHa, tHb, t

  ctra[30..26] := ctrb[30..26] := %00100    ' Counters A and B → NCO single-ended
  ctra[5..0] := 4                          ' Set pins for counters to control
  ctrb[5..0] := 6
  frqa := frqb := 1                        ' Add 1 to phs with each clock tick

  dira[4] := dira[6] := 1                  ' Set I/O pins to output

  tC := clkfreq                             ' Set up cycle time
  tHa := clkfreq/2                          ' Set up high times for both signals
  tHb := clkfreq/5
  t := cnt                                  ' Mark current time.

  repeat                                    ' Repeat PWM signal
    phsa := -tHa                             ' Define and start the A pulse
    phsb := -tHb                             ' Define and start the B pulse
    t += tC                                   ' Calculate next cycle repeat
    waitcnt(t)                               ' Wait for next cycle
```

A variable or constant can be used to store a time increment for pulse and cycle times. In the example below, the `tInc` variable stores `clkfreq/1_000_000`. When `tC` is set to `50_000 * tInc`, it means that the cycle time will be 500,000 μ s. Likewise, `tHa` will be 100,000 μ s.

```
' SinglePwmwithTimeIncrements.spin

CON

  _clkmode = xtall + pll16x          ' System clock → 80 MHz
  _xinfreq = 5_000_000

PUB TestPwm | tc, tHa, t, tInc

  ctra[30..26] := %00100              ' Configure Counter A to NCO
  ctra[5..0] := 4                      ' Set counter output signal to P4
  frqa := 1                            ' Add 1 to phsa with each clock cycle
  dira[4]~~                             ' P4 → output

  tInc := clkfreq/1_000_000            ' Determine time increment
  tC := 500_000 * tInc                 ' Use time increment to set up cycle time
  tHa := 100_000 * tInc                ' Use time increment to set up high time

  ' The rest is the same as 1Hz25PercentDutyCycle.spin

  t := cnt                              ' Mark counter time

  repeat                                ' Repeat PWM signal
    phsa := -tHa                       ' Set up the pulse
    t += tC                             ' Calculate next cycle repeat
    waitcnt(t)                         ' Wait for next cycle
```

Probe and Display PWM – Add an Object, Cog and Pair of Counters

Since the Propeller chip has multiple processors, some of them can be running application code while others are running monitoring and diagnostic code. In this example, we'll incorporate the MonitorPWM and FullDuplexSerialPlus objects (monitoring/diagnostic) into the TestDualPwm object (application) we tested in the previous section. The MonitorPWM object is important because it uses counters in a second cog to monitor the pulse trains transmitted by the cog executing the TestDualPwm code (which is also using two counters).

NOTE: After demonstrating an example of using the MonitorPWM object from within the TestDualPwmWithProbes object, the MonitorPWM object itself is examined in detail.

The TestDualPwmWithProbes application below is a modified version of TestDualPwm that makes it possible to monitor the pulse trains sent on P4 or P6 by probing them with P8. The probe information is then displayed on the Parallax Serial Terminal shown in Figure 7-20. The schematic in Figure 7-20 shows the P8 I/O pin probing P6. In other words, there is a jumper wire connecting P6 to P8. To probe P4, simply disconnect the P6 end of the P8→P6 jumper and connect it to P4. The measurements are displayed in the Parallax Serial Terminal in terms of 12.5 ns clock ticks; however, the application can easily be modified to display them in terms of ms, μ s, duty cycle, etc. A second instance of MonitorPWM can also be declared and used to simultaneously monitor a second channel.

Figure 7-20: Use P8 to Measure PWM Signal from P6

Parts List

(2) Resistors 100 Ω
(1) LED - green
(1) LED - yellow
(misc) Jumper wires

Schematic

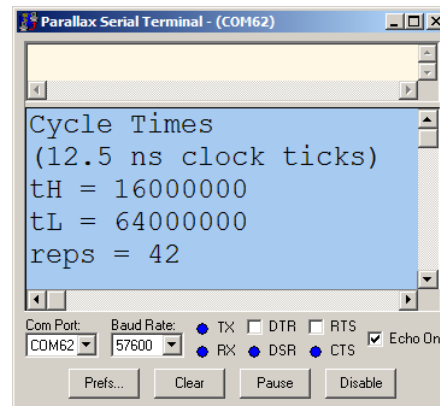
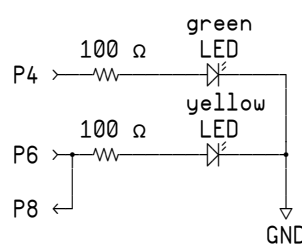

The code added to the TestDualPwm object to make it monitor and display the pulse trains is highlighted in the TestDualPwmWithProbes object below. Most of the code that was added is for displaying the values in the Parallax Serial Terminal. All that is needed to incorporate the MonitorPWM object is:

- Three variable declarations: tHprobe, tLprobe, and pulseCnt
- An object declaration: probe : "MonitorPWM"
- A call to the MonitorPWM object's start method that passes the addresses of tHprobe, tLprobe and pulseCnt, like this: probe.start(8, @tHprobe, @tLprobe, @pulseCnt).

After that, the MonitorPWM object automatically updates the values stored by tHprobe, tLprobe, and pulseCnt with each new cycle. These measurements are displayed in the Parallax Serial Terminal with debug.dec(tHprobe), debug.dec(tLprobe), and debug.dec(pulseCnt).

- ✓ Make sure TestDualPwmWithProbes.spin object is saved to the same folder as MonitorPwm.spin and FullDuplexSerialPlus.spin.
- ✓ Use the Propeller Tool to load TestDualPwmWithProbes.spin into EEPROM (F11) and immediately click the Parallax Serial Terminal's Enable button.

7: Counter Modules and Circuit Applications Lab

- ✓ Disconnect the end of the P8 → P6 jumper wire that is connected to P6 and connect it to P4. The display should update to reflect the different high and low times.

```
{{
TestDualPwmWithProbes.spin
Demonstrates how to use an object that uses counters in another cog to measure (probe) I/O
pin activity caused by the counters in this cog.
}}

CON

  _clkmode = xtal1 + pll16x          ' System clock → 80 MHz
  _xinfreq = 5_000_000

  ' Parallax Serial Terminal constants
  CLS = 16, CR = 13, CLREOL = 11, CRSRXY = 2

OBJ

  debug : "FullDuplexSerialPlus"
  probe : "MonitorPWM"

PUB TestPwm | tc, tHa, tHb, t, tHprobe, tLprobe, pulseCnt

  ' Start MonitorServoControlSignal.
  probe.start(8, @tHprobe, @tLprobe, @pulseCnt)

  ' Start FullDuplexSerialPlus.
  Debug.start(31, 30, 0, 57600)
  waitcnt(clkfreq * 2 + cnt)
  Debug.str(String(CLS, "Cycle Times", CR, "(12.5 ns clock ticks)", CR))

  Debug.str(String("tH = ", CR))
  Debug.str(String("tL = ", CR))
  Debug.str(String("reps = "))

  ctra[30..26] := ctrb[30..26] := %00100    ' Counters A and B → NCO single-ended
  ctra[5..0] := 4                            ' Set pins for counters to control
  ctrb[5..0] := 6
  frqa := frqb := 1                          ' Add 1 to phs with each clock tick

  dira[4] := dira[6] := 1                    ' Set I/O pins to output

  tC := clkfreq                               ' Set up cycle time
  tHa := clkfreq/2                            ' Set up high times for both signals
  tHb := clkfreq/5
  t := cnt                                    ' Mark current time.

  repeat                                     ' Repeat PWM signal
    phsa := -tHa                              ' Define and start the A pulse
    phsb := -tHb                              ' Define and start the B pulse
    t += tC                                    ' Calculate next cycle repeat

  ' Display probe information
  debug.str(String(CLREOL, CRSRXY, 5, 2))
  debug.dec(tHprobe)
  debug.str(String(CLREOL, CRSRXY, 5, 3))
  debug.dec(tLprobe)
  debug.str(String(CLREOL, CRSRXY, 7, 4))
  debug.dec(pulseCnt)

  waitcnt(t)                                ' Wait for next cycle
```

Monitoring PWM – Example of an Object that Uses Counters in Another Cog

The MonitorPWM object below can be used by other objects to measure the characteristics of a pulse train (its high and low times). Code in some other cog can be transmitting pulses, and the application can use this object to measure the high and low times of the pulses. Up to this point, all objects have been using the counter modules in cog 0. In contrast, the MonitorPWM object launches a new cog and uses that new cog's counter modules to measure the pulse high and low times. It then makes its measurements available to the other objects by storing them at mutually agreed-upon locations in main RAM.

Here are three important tips for writing objects that launch new cogs and use those cogs' counter modules. Keep them in mind as you examine the MonitorPWM object:

- 1) If the object is launching a new cog, it should have `start` and `stop` methods and global variables named `cog` and `stack`. This is a convention introduced by Parallax that is used in the Propeller Library and the Propeller Object Exchange. The object should also declare any global variables required by the process that gets launched into the new cog. (This was all introduced in the Objects lab.)
- 2) The `start` method should copy any parameters it receives to global variables before launching the method that manages the process into a new cog.
- 3) **The method that gets launched into a new cog should make counter configurations and I/O pin assignments.**

Regarding tip 3: Let's say that cog 0 calls your object's `start` method, and the `start` method launches a counter-using method into cog 1 with the `cognew` command. You have to put code that does counter configuration and I/O pin assignments into the method that gets launched by `cognew` if you want the counter modules in cog 1 to work. If you try to configure the counters or I/O pins in the `start` method (before the cog gets launched), those configurations affect cog 0 instead of cog 1. This would in turn create program bugs because the counter modules in cog 1 will not be able to access the I/O pins.

```
{  
MonitorPWM.spin  
  
Monitors characteristics of a probed PWM signal, and updates addresses in main RAM  
with the most recently measured pulse high/low times and pulse count.  
  
How to Use this Object in Your Application  
-----  
1) Declare variables for high time, low time, and pulse count. Example:  
  
VAR  
    long tHprobe, tLprobe, pulseCnt  
  
2) Declare the MonitorPWM object. Example:  
  
OBJ  
    probe : MonitorPWM  
  
3) Call the start method and pass the I/O pin used for probing and the variable addresses  
from step 1. Example:  
  
PUB MethodInMyApp  
    ...  
    probe.start(8, @tHprobe, @tLprobe, @pulseCnt)  
  
4) The application can now use the values of tHprobe, tLprobe, and pulseCnt to monitor  
the pulses measured on the I/O pin passed to the start method (P8 in this example).
```

7: Counter Modules and Circuit Applications Lab

In this example, this object will continuously update tHprobe, tLprobe, and pulseCnt with the most recent pulse high/low times and pulse count.

See Also

TestDualPwmWithProbes.spin for an application example.

}}

VAR

```
long cog, stack[20]           ' Tip 1, global variables for cog and stack.
long apin, thaddr, tladdr, pcntaddr ' Tip 1, global variables for the process.
```

PUB start(pin, thighAddr, tlowaddr, pulseCntAddr) : okay

```
'' Starts the object and launches PWM monitoring process into a new cog.
'' All time measurements are in terms of system clock ticks.
''
'' pin - I/O pin number
'' thighAddr - address of long that receives the current signal high time measurement.
'' tlowAddr - address of long that receives the current signal low time measurement.
'' pulseCntAddr - address of long that receives the current count of pulses that have
''                been measured.

' Copy method's local variables to object's global variables
' You could also use longmove(@apin, @pin, 4) instead of the four commands below.
apin := pin                    ' Tip 2, copy parameters to global variables
thaddr := thighAddr           ' that the process will use.
tladdr := tlowAddr
pcntaddr := pulseCntAddr

' Launch the new cog.
okay := cog := cognew(PwmMonitor, @stack) + 1
```

PUB stop

```
'' Stop the PWM monitoring process and free a cog.

if cog
  cogstop(cog~ - 1)
```

PRI PwmMonitor

```
' Tip 3, set up counter modules and I/O pin configurations(from within the new cog!)

ctra[30..26] := %01000          ' POS detector
ctra[5..0] := apin              ' I/O pin
frqa := 1

ctrb[30..26] := %01100          ' NEG detector
ctrb[5..0] := apin              ' I/O pin
frqb := 1

phsa~
phsb~                            ' Clear counts

' Set up I/O pin directions and states.
dira[apin]~                       ' Make apin an input

' PWM monitoring loop.

repeat                              ' Main loop for pulse
  waitpeq(|<apin, |<apin, 0)      ' monitoring cog.
  long[tladdr] := phsb           ' Wait for apin to go high.
  phsb~                          ' Save tlow, then clear.
```

Counter Modules and Circuit Applications Lab

```
waitpeq(0, |<apin,0)          ' Wait for apin to go low.
long[thaddr] := phsa          ' Save thigh then clear.
phsa~
long[pcntaddr]++             ' Increment pulse count.
```

Inside the MonitorPWM Object

The first thing MonitorPWM does is declare its global variables. Variables named `cog` and `stack` were introduced in the Objects lab. The `cog` variable is used to keep track of which cog the object's `start` method launched the process into. Later, if this object's `stop` method gets called, it knows which cog to shut down. Since two methods use this variable, it has to be global because methods cannot see each other's local variables. The `stack` variable provides stack space for the code that gets launched into the new cog for calculations, return pointers, etc.

```
VAR
  long cog, stack[20]          ' Tip 1, global variables for cog and stack.
  long apin, thaddr, tladdr, pcntaddr ' Tip 1, global variables for the process.
```

Global variables named `apin`, `thaddr`, `tladdr`, and `pcntaddr` are also declared. These variables get used by two different methods: `start` and `pwmMonitor`. The `start` method receives parameters from an object that calls it and copies them into these global variables so that the `pwmMonitor` method can use them. The `PwmMonitor` method uses the `apin` variable to configure I/O pins, and it uses the other three variables as address pointers for storing its measurements at the “mutually agreed upon locations in main RAM” mentioned earlier.

When another object calls this object's `start` method, it passes the I/O pin number that will be doing the signal monitoring along with addresses where the high and low pulse time measurements should be stored and an address to store the number of pulses that have been counted. Keep in mind that these parameters (`pin`, `thighAddr`, `tlowaddr`, `pulseCntAddr`) are local variables in the `start` method. To make these values available to other methods, the `start` method has to copy them to global variables. So, before launching the new cog, the `start` method copies `pin` to `apin`, `tHighAddr` to `thaddr`, `tLowAddr` to `tladdr` and `pulseCntAddr` to `pcntaddr`. After that, the `cognew` command launches the `PwmMonitor` method into a new cog and passes the address of the `stack` array. The `stack` array was introduced in the Objects lab.

```
PUB start(pin, thighAddr, tlowaddr, pulseCntAddr) : okay
  ...
  ' Copy method's local variables to object's global variables
  apin := pin          ' Tip 2, copy parameters to global variables
  thaddr := tHighAddr ' that the process will use.
  tladdr := tLowAddr
  pcntaddr := pulseCntAddr

  ' Launch the new cog.
  okay := cog := cognew(PwmMonitor, @stack) + 1
```

Objects that launch new cogs that are designed to exchange information with other objects have `start` and `stop` methods by convention. Also by convention, if your object does not launch a new cog but it does need to be configured, use a method named `init` or `config` instead.

Look at the last line in the `start` method above. The `cognew` command returns -1 if there were no available cogs, or the number of the cog that the `PwmMonitor` method got launched into, which could be 0 to 7. Next, one gets added to this value, and the result is stored in the object's `cog` variable and the `start` method's `okay` return value. So, the `start` method returns 0 (false) if the process failed to launch or nonzero if it succeeded. The object calling the `start` method can then use the value the `start` method returns in an `if` block to decide what to do. Again, if the value returned is 0 (false) it

7: Counter Modules and Circuit Applications Lab

means there were no cogs available; whereas, if the value is nonzero, the application knows the cog successfully launched.

The `stop` method can also determine if the process was successfully launched because the `cog` variable also stores the result `cognew` returned, plus one. If the `stop` method gets called, the first thing it does is use an `if` statement to make sure there's really a cog that was started. For the third time, if the value of `cog` is zero, there's not currently a process under this object's control that needs to be stopped. On the other hand, if the value of `cog` is nonzero, `cogstop(cog~ - 1)` does 3 things:

- 1) Subtract 1 from the value stored by `cog` to get the number of the cog that needs to be stopped. (Remember, a command in the `start` method added 1 to the `cog` variable).
- 2) Stop the cog.
- 3) Clear the value of `cog` so that the object knows it's not currently in charge of an active process (`cog`).

```
PUB stop
```

```
    ' Stop the PWM monitoring process and free a cog.
```

```
    if cog
        cogstop(cog~ - 1)
```

The `PwmMonitor` method gets launched into a new cog by a `cognew` command in the `start` method. So code in the `PwmMonitor` method is running in a separate processor from the code that called the `start` method. The first thing the `PwmMonitor` method does is configure the counter modules and I/O pins it is going to use. Remember, your code cannot do this from another cog; code executed by a given cog has to make its own counter configurations and I/O pin assignments. (See tip 3, discussed earlier.)

```
PRI PwmMonitor
```

```
    ' Tip 3, set up counter modules and I/O pin configurations(from within the new cog!)
```

```
    ctra[30..26] := %01000          ' POS detector
    ctra[5..0]  := apin             ' I/O pin
    frqa := 1
```

```
    ctrb[30..26] := %01100          ' NEG detector
    ctrb[5..0]  := apin             ' I/O pin
    frqb := 1
```

```
    phsa~          ' Clear counts
    phsb~
```

```
    ' Set up I/O pin directions and states.
    dira[apin]~    ' Make apin an input
```

```
    ' PWM monitoring loop.
```

Counter Modules and Circuit Applications Lab

The main loop in the `PwmMonitor` method waits for the signal to be high. Then it copies the contents of `phsb`, which accumulates the low time, to an address in main RAM. Remember that the address in main memory was passed to the `start` method's `thighaddr` parameter. The `start` method copied it to the global `thaddr` variable. Since `thaddr` is a global variable, it's accessible to this method too. Likewise with `tlowaddr` → `tladdr` and `pulsecntaddr` → `pcntaddr`. Before waiting to measure the signal's low time, the code clears the `phsb` register for the next measurement. After the signal goes low, it copies `phsa` to the memory set aside for measuring the high time. Before the next cycle gets measured, 1 gets added to the memory pointed to by the `pcntaddr` variable, which tacks the number of cycles.

```
' PWM monitoring loop.
repeat                                     ' Main loop for pulse
                                           ' monitoring cog.
    waitpeq(|<apin, |<apin, 0)             ' Wait for apin to go high.
    long[tladdr] := phsb                  ' Save tlow, then clear.
    phsb~
    waitpeq(0, |<apin, 0)                 ' Wait for apin to go low.
    long[thaddr] := phsa                  ' Save thigh then clear.
    phsa~
    long[pcntaddr]++                       ' Increment pulse count.
```

PLL Modes for High-Frequency Applications

Up to this point, we have used NCO modes for generating square waves in the audible (20 to 20 kHz) and IR detector (38 kHz) range. The NCO modes can be used to generate signals up to `clkfreq/2`. So, with the P8X32A Propeller chip used in these labs, the ceiling frequency for this mode is 40 MHz.

For signals faster than `clkfreq/2`, you can use the counter module's PLL (phase-locked loop) modes. Instead of sending bit 31 of the PHS register straight to an I/O pin, PLL mode passes the signal through two additional subsystems before transmitting it. These subsystems are not only capable of sending frequencies from 500 kHz to 128 MHz, they also diminish the jitter inherent to NCO signals. The first subsystem (counter PLL) takes the frequency that bit 31 of the PHS register toggles at, and multiplies it by 16 using a voltage-controlled oscillator (VCO) circuit. The Propeller Manual and CTR object call this the VCO frequency. The second subsystem (divider) divides the resulting frequency by a power of 2 ranging from 1 to 128.

The PLL is designed to accept PHS bit 31 frequencies from 4 to 8 MHz. The PLL subsystem multiplies this input frequency by 16, for a counter PLL frequency ranging from 64 to 128 MHz. The divider subsystem then divides this frequency by a power of two from 128 to 1, so the final output for PLL signals can range from 500 kHz to 128 MHz.

Configuring the Counter Module for PLL Modes

Figure 7-21 is the now-familiar excerpt from the Propeller Library's CTR object, this time with the PLL modes listed. There are three PLL Modes. The first one, PLL internal, is used for synchronizing video signals. Although not discussed in this lab, you can see it applied in the Propeller Library's TV object.

As with the NCO and Duty modes, there are single-ended and differential PLL mode options. The CTRMODE values for routing the PLL signal to I/O pins are %00010 for single-ended, and %00011 for differential.

Figure 7-21: PLL Mode Excerpts from the CTR Object's Counter Mode Table

CTRMODE	Description	Accumulate FRQ to PHS	APIN output*	BPIN output*
%00000	Counter disabled (off)	0 (never)	0 (none)	0 (none)
.
%00001	PLL internal (video mode)	1 (always)	0	0
%00010	PLL single-ended	1	PLL	0
%00011	PLL differential	1	PLL	!PLL
.
%11111	LOGIC always	1	0	0

* must set corresponding DIR bit to affect pin

A¹ = APIN input delayed by 1 clock
 A² = APIN input delayed by 2 clocks
 B¹ = BPIN input delayed by 1 clock

The CTR Register's PLLDIV bit Field

With NCO mode, setting I/O pin frequencies was done directly through the FRQ register. The value in FRQ was added to PHS every clock tick, and that determined the toggle rate of PHS bit31, which directly controlled the I/O pin. While setting I/O pin frequencies with PLL mode still uses PHS bit 31, there are some extra steps.

In PLL mode, the toggle rate of PHS bit 31 is still determined by the value of FRQ, but before the I/O pin transmits the signal, the PHS bit 31 signal gets multiplied by 16 and then divided down by a power of two of your choosing ($2^0 = 1$, $2^1 = 2$, $2^2 = 4$, ... $2^6 = 64$, $2^7 = 128$). The power of 2 is selected by a value stored in the CTR register's PLLDIV bit field, (bits 25..23) in Figure 7-22.

Figure 7-22: CTR/A/B Register Map from CTR.spin

bits	31	30..26	25..23	22..15	14..9	8..6	5..0
Name	—	CTRMODE	PLLDIV	—	BPIN	—	APIN

Calculating PLL Frequency Given FRQ and PLLDIV

Let's say you are examining a code example or object that's generating a certain PLL frequency. You can figure out what frequency it's generating using the values of `clkfreq`, the FRQ register, and the value in the CTR register's PLLDIV bit field. Just follow these three steps:

- (1) Calculate the PHS bit 31 frequency:

$$\text{PHS bit 31 frequency} = \frac{\text{clkfreq} \times \text{FRQ register}}{2^{32}}$$

- (2) Use the PHS bit 31 frequency to calculate the VCO frequency:

$$\text{VCO frequency} = 16 \times \text{PHS bit 31 frequency}$$

- (3) Divide the PLLDIV result, which is $2^{7-\text{PLLDIV}}$ into the VCO frequency:

$$\text{PLL frequency} = \frac{\text{VCO frequency}}{2^{7-\text{PLLDIV}}}$$

Example: Given a system clock frequency (`clkfreq`) of 80 MHz and the code below, calculate the PLL frequency transmitted on I/O Pin P15.

```
'Configure ctra module
ctra[30..26] := %00010
frqa := 322_122_547
ctra[25..23] := 2
ctra[5..0] := 15
dira[15]~~
```

- (1) Calculate the PHS bit 31 frequency:

$$\begin{aligned} \text{PHS bit 31 frequency} &= \frac{80_000_000 \times 322_122_547}{2^{32}} \\ &= 5_999_999 \end{aligned}$$

- (2) Use the PHS bit 31 frequency to calculate the VCO frequency:

$$\begin{aligned} \text{VCO frequency} &= 16 \times 5_999_999 \\ &= 95_999_984 \end{aligned}$$

- (3) Divide the PLLDIV result ($2^{7-\text{PLLDIV}}$) into the VCO frequency:

$$\begin{aligned} \text{PLL frequency} &= \frac{95_999_984}{2^{7-2}} \\ &= 2_999_999 \text{ MHz} \\ &\approx 3 \text{ MHz} \end{aligned}$$

Calculating FRQ and PLLDIV Given a PLL Frequency

Figuring out the PLL frequency given some pre-written code is well and good, but what if you want to calculate FRQ register and PLLDIV bit fields values to generate a frequency with your own code? Here are four steps you can use to figure it out:

- (1) Use the table below to figure out which value to put in the CTR register's PLLDIV bit field based on the frequency you want to transmit.

MHz	PLLDIV	MHz	PLLDIV
0.5 to 1	0	8 to 16	4
1 to 2	1	16 to 32	5
2 to 4	2	32 to 64	6
4 to 8	3	64 to 128	7

- (2) Calculate the VCO frequency with the PLL frequency you want to transmit and the PLL divider, and round down to the next lowest integer.

$$\text{VCO frequency} = \text{PLL frequency} \times 2^{(7-\text{PLLDIV})}$$

- (3) Calculate the PHS bit 31 frequency you'll need for the VCO frequency. It's the VCO frequency divided by 16.

$$\text{PHS bit 31 frequency} = \text{VCO frequency} \div 16$$

- (4) Use the NCO frequency calculations to figure out the FRQ register value for the PHS bit 31 frequency.

$$\text{FRQ register} = \text{PHS bit 31 frequency} \times \frac{2^{32}}{\text{clkfreq}}$$

Example: `clkfreq` is running at 80 MHz, and you want to generate a 12 MHz signal with PLL. Figure out the FRQ register and PLLDIV bit fields.

- (1) Use the table to figure out which value to put in the CTR register's PLLDIV bit field:

Since 12 MHz falls in the 4 to 16 MHz range, PLLDIV is 4.7. Round down, and use 4.

- (2) Calculate the VCO frequency with the final PLL frequency and the PLL divider:

$$\begin{aligned} \text{VCO frequency} &= 12 \text{ MHz} \times 2^{(7-4)} \\ &= 12 \text{ MHz} \times 8 \\ &= 96 \text{ MHz} \end{aligned}$$

- (3) Calculate the PHS bit 31 frequency you'll need for the VCO frequency. It's the VCO frequency divided by 16:

$$\begin{aligned} \text{PHS bit 31 frequency} &= 96 \text{ MHz} \div 16 \\ &= 6 \text{ MHz} \end{aligned}$$

- (4) Use the NCO frequency calculations to figure out the FRQ register value for the PHS bit 31 frequency:

$$\begin{aligned} \text{FRQ register} &= 6 \text{ MHz} \frac{2^{32}}{80 \text{ MHz}} \\ &= 322_122_547 \end{aligned}$$

Testing PLL Frequencies

The TestPllParameters object lets you control Counter A's PLL output frequency by hand-entering values for `frqa` and also for `ctra`'s PLLDIV bit field into Parallax Serial Terminal (Figure 7-23). The program transmits the frequency you entered for 1 s, counting the cycles with Counter B set to NEGEDGE detector mode.

Note that there is a slight difference between the measured frequency and the hand-calculated frequency discussed earlier. If the `delay := clkfreq + cnt` calculation in the object TestPllParameters.spin is placed immediately before `phsb~`, the frequency count will be slightly less than the actual frequency. If it were moved below `phsb~`, the measurement will be slightly larger than the actual frequency. An exact measurement can be obtained with the help of an assembly language object.

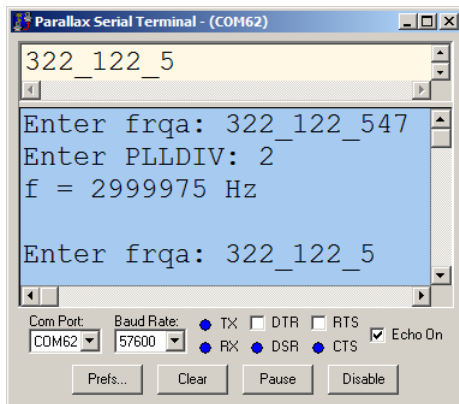

Figure 7-23: Calculate Frequency Given FRQA and PLLDIV

Although the PLL can generate frequencies up to 128 MHz, the Propeller chip's counters can only detect frequencies up to 40 MHz with counter modules. This concurs with the Nyquist sampling rate, which must be twice as fast as the highest frequency it could possibly measure. Also, if you consider that the NEGEDGE detector mode adds FRQ to PHS when it detects a high signal during one clock tick and a low signal during the next, it needs at least two clock ticks to detect a signal's full cycle.

- ✓ Calculate FRQ register and PLLDIV bit field values for various frequencies in the 500 kHz to 40 MHz range.
- ✓ Use the Propeller Tool to load TestPllParameters.spin into EEPROM (F11) and immediately click the Parallax Serial Terminal's *Enable* button.
- ✓ Enter the FRQ and PLLDIV values into the Parallax Serial Terminal's Transmit windowpane at the prompts and verify that the measured frequency is in the same neighborhood as your calculations.

```
{{
TestPllParameters.spin

Tests PLL frequencies up to 40 MHz. PHS register and PLLDIV bit field values are
entered into Parallax Serial Terminal. The Program uses these to synthesize square wave
with PLL mode using counter module A. Counter module B counts the cycles in 1 s
and reports it.
}}

CON

    _clkmode = xtal1 + pll16x          ' System clock → 80 MHz
    _xinfreq = 5_000_000
```

```
' Constants for Parallax Serial Terminal.
CLS = 16, CR = 13

OBJ

SqrWave : "SquareWave"
debug   : "FullDuplexSerialPlus"

PUB TestFrequency | delay, cycles

Debug.Start(31, 30, 0, 57600)
waitcnt(clkfreq * 2 + cnt)
Debug.tx(CLS)

' Configure counter modules.
ctra[30..26] := %00010          ' ctra module to PLL single-ended mode
ctra[5..0]  := 15

ctrb[30..26] := %01110        ' ctrb module to NEGEDGE detector
ctrb[5..0]  := 15
frqb:= 1

repeat

Debug.str(String("Enter frqa: "))          ' frqa and PLLDIV are user input
frqa := Debug.GetDec

Debug.str(String("Enter PLLDIV: "))
ctra[25..23] := Debug.GetDec

dira[15]~~                                ' P15 → output
delay := clkfreq + cnt                    ' Precalculate delay ticks
phsb~                                     ' Wait 1 s.
waitcnt(delay)
cycles := phsb                             ' Store cycles
dira[15]~                                 ' P15 → input

Debug.str(String("f = "))                  ' Display cycles as frequency
debug.dec(cycles)
debug.str(String(" Hz", CR, CR))
```

Metal Detection with PLL and POS Detector Modes and an LC Circuit

Inductors are coils that, when placed in a circuit, have the capacity to store energy. They get used in many types of applications, one of which is metal detection. There are lots of different kinds of metal detection instruments aside from the ones you may have seen passed over the sands on just about any beach on any given weekend. Other examples include instruments that identify the type of metal, check for stress fractures in metal surfaces, and precisely measure the distance of a metal surface from an instrument.

Even though there aren't any inductors in the PE kit, there are lots of wires that can be shaped into metal loops to create small inductors. This portion of the lab demonstrates how a cog can use two counters, one in single-ended PLL mode and the other in POS detector mode, to send high-frequency signals into an LC (inductor-capacitor) circuit's input, and infer the presence or absence of metal by examining the circuit's output signal.

Counter Modules and Circuit Applications Lab

For our project, we need only to bend a jumper wire into a U-shaped half-loop to create our inductor “coil.” Figure 7-24 shows a parts list and circuit for the PE Kit’s metal detector. Because of the small part sizes and high frequencies involved, this circuit can be finicky. So, for best results, wire it exactly like the breadboard photo shown in Figure 7-25. The capacitor and resistors should all be sticking straight up off the board, and the two wires should be on the same plane as the board.

This circuit will also require some tuning. Figure 7-24 starts with R1 at 100 Ω, and R2 (100 Ω) and R3 (470 Ω) are in parallel. The notation these labs will use for parallel resistor combinations is R2 || R3. Your particular circuit may require a larger or smaller resistor in parallel with either R1 or R2, but for now, start with R1 = 100 Ω and R2 = 100 Ω || 470 Ω.

- ✓ Build the circuit in Figure 7-24 on your PE Platform exactly as shown in Figure 7-25. For a list of kit components, see Appendix C: PE Kit Components Listing on page 219.

Figure 7-24: Metal Detector Parts and Schematic

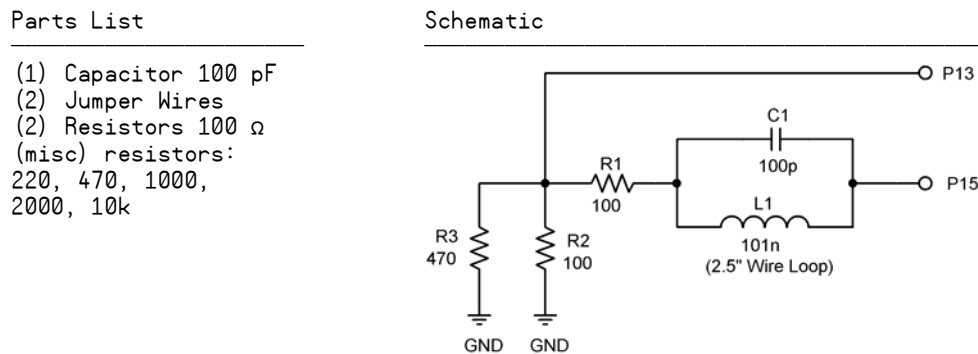

- ✓ Make sure the U-shaped jumper wire you are using for an inductor is parallel to the surface of the board while the other parts are perpendicular.

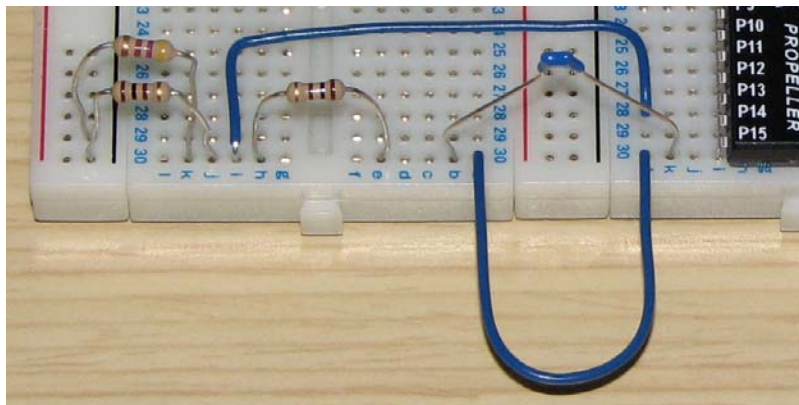

Figure 7-25: Metal Detector Wiring

Detecting Resonant Frequency

The LC circuit shown in Figure 7-24 is commonly called a bandreject, bandstop, or notch filter. The filter attenuates a certain frequency sine wave component from an input signal, ideally down to nothing at a certain frequency. The frequency that gets filtered is called the filter’s center frequency as well as the LC circuit’s resonant frequency. Figure 6-1 shows a simulated plot of how the filter responds to a range of input (P15) sine wave frequencies from 30 to 90 MHz. Notice that the filter’s center frequency is 50 MHz. So, if the input were a sine wave, its amplitude would be attenuated

7: Counter Modules and Circuit Applications Lab

almost to nothing; whereas at frequencies well outside the filter's center frequency, the output sine wave amplitude would instead be in the 1.6 V neighborhood.

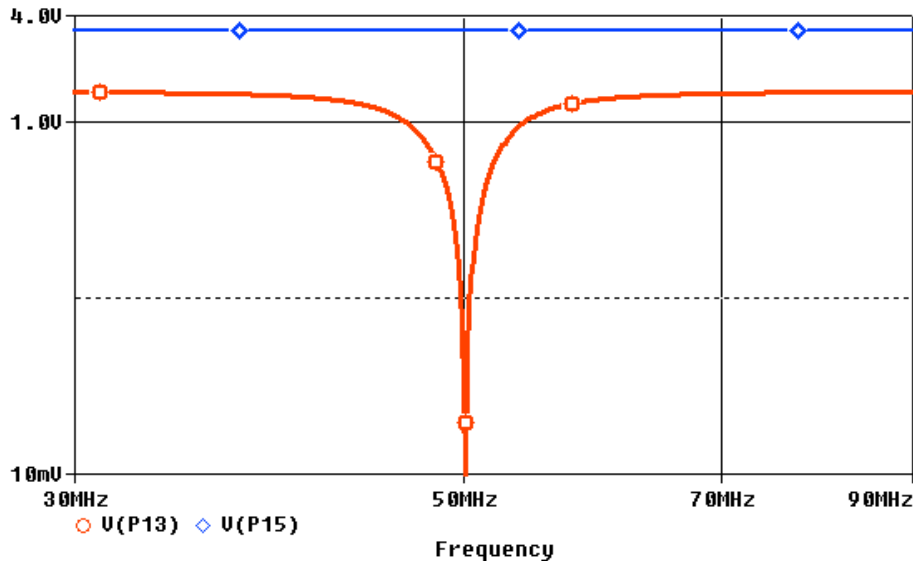

Figure 7-26:
Simulated P13
Output Vs. P15
Input for Sine
Waves
Frequencies

More about filters and simulation software:



If you swap R and C || L, you will have a bandpass filter. The frequency response is the upside-down version of what's shown in Figure 20. For more information on LC filters, look up terms *frequency selective circuits*, *filters*, *low-pass*, *high-pass*, *bandpass* and *bandreject* in an electronics textbook.

The simulations in this section were performed with OrCAD Demo Software, which is available for free download from www.cadence.com.

Regardless of whether it's a bandreject or bandpass filter, the circuit's resonant frequency can be calculated with the equation shown below. L is the inductor's inductance, measured in henrys (H), and C is the capacitor's capacitance, measured in farads (F). Of course, the L and C in Figure 7-24 are minute fractions of henrys and farads, respectively.

$$f_R = \frac{1}{2\pi\sqrt{LC}} \quad \text{Eq. 6}$$

Rearranging terms makes it possible to calculate the inductance (L) based on frequency response tests.

$$L = \frac{1}{(2\pi f_R)^2 C} \quad \text{Eq. 7}$$

In this lab, the LC circuit's input will be a square wave from P15. Although the output is still related to the circuit's filtering characteristics, its behavior will make a lot more sense if examined from the *step response* standpoint. A circuit's step response is especially important to digital circuits, and the typical goal is to make the circuit's output quickly and accurately respond to the input and settle at its new value. The most desirable step response is called *critically damped* because it reaches the target value as quickly as possible without overshooting it. Some designs can get quicker responses with an *underdamped* circuit, but at a penalty of some oscillation above and below the new target voltage

Counter Modules and Circuit Applications Lab

before the signal settles down. Other designs need an *overdamped* step response, which is slower to reach its target voltage, but ensures that no overshoot or ringing will occur.

The simulated step response shown in Figure 7-27 is a fairly drastic case of an underdamped step response. $V(P15Step)$ in the upper plot is the LC circuit's input signal. $V(P13)$ is the output signal, and $V(Threshold)$ is a DC signal at the Propeller chip's 1.65 V threshold. The simulation is not really a typical step response because a 50 MHz square wave was applied for 960 ns before the so-called step (high signal) was applied. The result was that the inductor and capacitor both accumulated some stored energy, which makes $V(P13)$'s pseudo-step response to the right of the 960 ns mark more pronounced than it would otherwise be. The important thing to notice about $V(P13)$ to the right of the 960 ns mark is that it's a sine wave that decays gradually. This sine wave occurs at the LC circuit's 50 MHz resonant frequency.

Figure 7-27: P13 Response to Resonant Frequency at P15

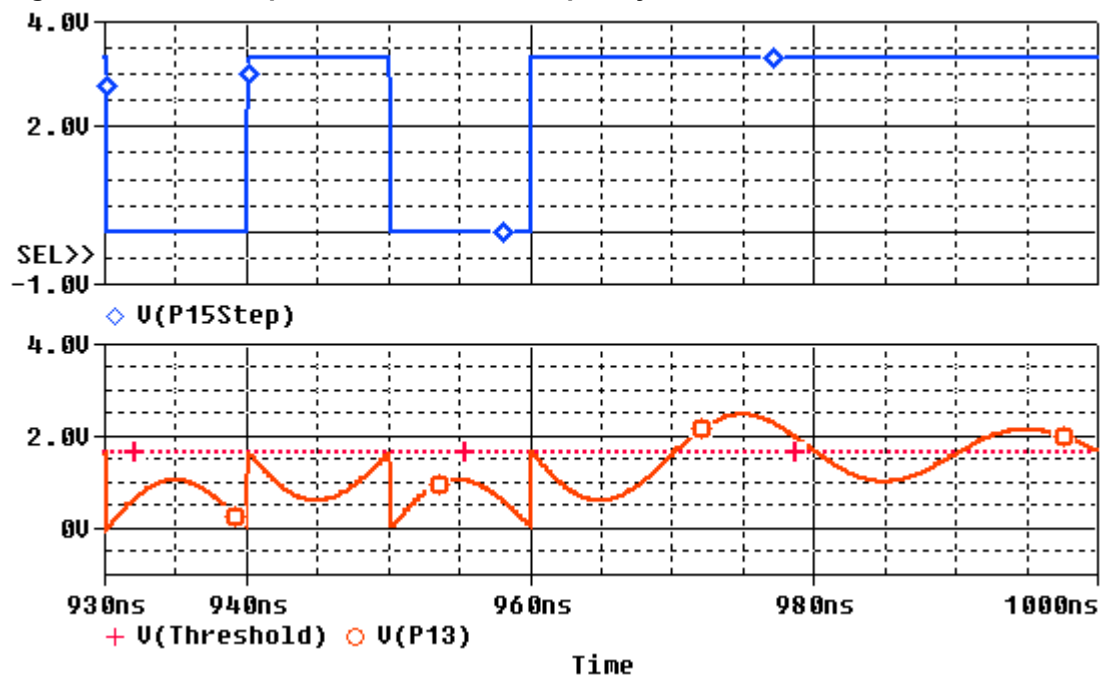

Also, take a look at the $V(P13)$ trace between 930 and 960 ns. With each transition of the 50 MHz $V(P15Step)$ signal, $V(P13)$ starts a sine wave reaction that initially opposes the $V(P15Step)$ input signal. Since the $V(P13)$ signal only gets through half of its 50 MHz sine wave response before the $V(P15Step)$ signal changes, the portions of those sine wave responses never make it above the Propeller chip's 1.65 V threshold.

Next, compare the $V(P13)$ response to square wave frequencies slightly above and below the circuit's 50 MHz resonant frequency, shown in Figure 7-28. At 47.62 MHz, the sine wave completes slightly more than $\frac{1}{2}$ of its cycle, part of which has climbed above the 1.65 V threshold voltage (designated by the line with the + characters). At 49.02 MHz, the sine wave is still repeating more than a full cycle, but not as much, so the signal spends less time above the threshold voltage. At 50 MHz, the input frequency matches the sinusoidal response, and since only half the sine wave repeats, the signal doesn't spend any time above the threshold voltage. At 51.02 and 52.63 MHz, the signal again spends some time above the 1.65 V I/O pin threshold, this time because the input signal changes before the sine wave has completed its cycle.

Figure 7-28: LC Circuit P13 Output Responses at Various Frequencies

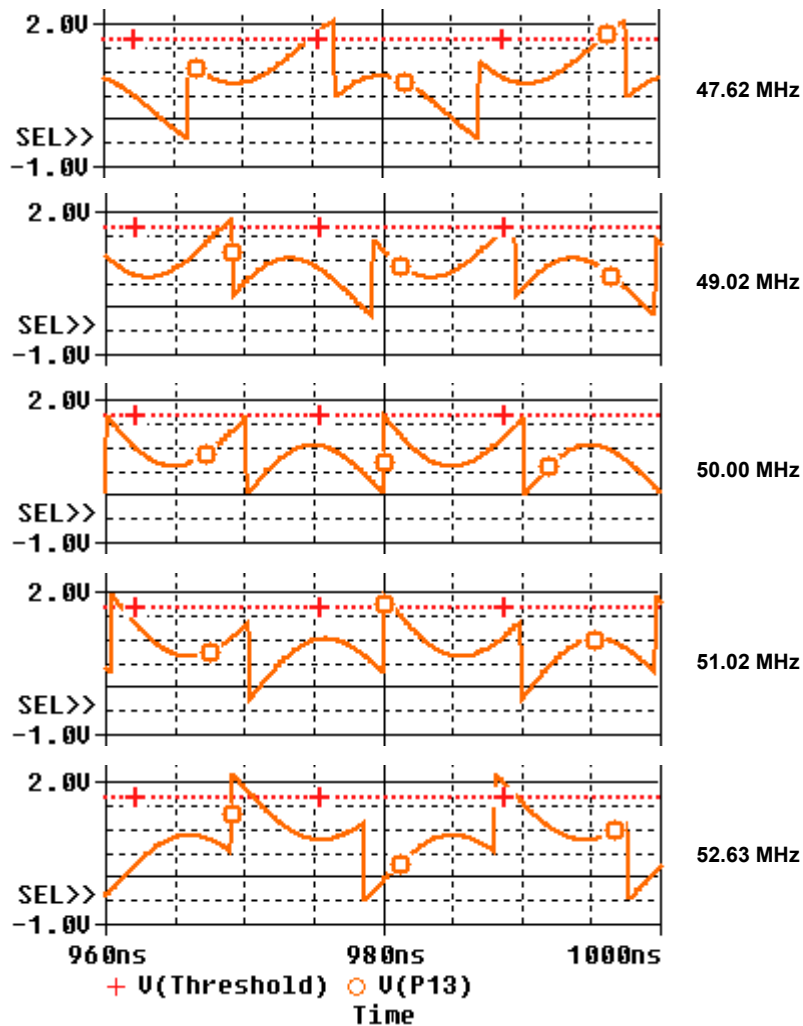

The most important thing Figure 7-28 indicates is that the output signal, which can be monitored by P13, will spend more time above the I/O pin's logic threshold when the P15 input signal is further away from the circuit's resonant frequency, either above or below. The Propeller can use a counter in PLL mode to generate square waves in the range of frequencies shown in Figure 7-28, and it can use another counter in POS detector mode to track how long the circuit's output signal spends above the P13 I/O pin's threshold voltage.

So, the Propeller chip can use two counter modules and a small amount of code to sweep the P15 PWM frequency through a range of values to find the resonant frequency of the Figure 7-24 circuit, but how does that make it possible to detect metal? The answer is that a nearby metal object electromagnetically interacts with the Figure 7-24 circuit's wire loop inductor in such a way that it changes its inductance, and also adds a small amount of resistance. When the circuit's inductance changes, its resonant frequency also changes, and the Propeller chip can detect that by sweeping P15 PLL frequencies and measuring P13 high times, which will reach a minimum at a different resonant frequency as a result of a nearby metal object.

How Eddy Currents in a nearby Metal Object Affect the Loop's Resonant Frequency

Figure 7-29 illustrates the electromagnetic interaction between a nearby metal object and the wire's loop inductance. The alternating currents through the loop cause alternating electromagnetic fields. These alternating magnetic fields cause groups of electrons in the conductive metal to travel in alternating circular paths. These magnetically induced circular paths are called *eddy currents*. The alternating eddy currents generate magnetic fields that oppose the fields generated by the wire loop.

Figure 7-29: Eddy Currents Causing Opposing Magnetic Fields

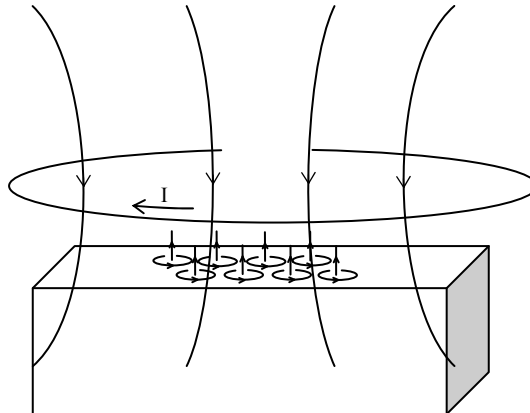

The eddy currents shown in Figure 7-29 provide a very small, high-frequency example of how power is transferred in AC lines. A coil connected to the power line is typically magnetically coupled with a coil of fewer turns. The alternating current in the primary induces an alternating magnetic field that induces AC current in the secondary winding. Figure 7-30 shows how the secondary winding and load affect the primary. The secondary winding's inductance and any resistive load can be seen in the primary, and can be accounted for as $L2'$ and R' .

Figure 7-30: Eddy Current's Effects on the Loop's Inductance

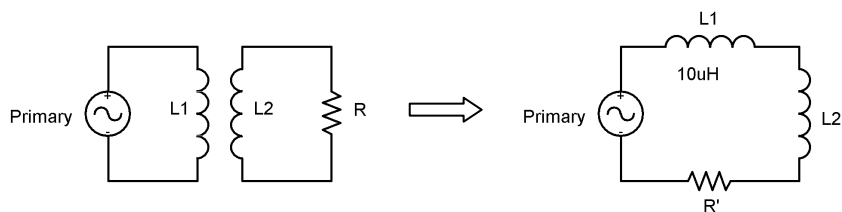

Figure 7-30 also represents how eddy currents, which have a certain inductance due to the fact that eddies (circular electron currents) are induced in the metal, affect the primary circuit's inductance and resistance. So, eddy currents in the nearby metal object affect the metal loop's inductance. Since the loop's inductance is measured by L in the resonance equation, it will change the LC circuit's resonant frequency. Also, since the Propeller chip can detect the circuit's resonant frequency by sweeping PLL square wave frequencies on one pin while measuring the number of ticks the circuit's output signal is above the threshold on another, the application can detect the presence or absence of nearby metals.

Testing for Resonant Frequency

The Calibrate Metal Detector object below provides an interface for testing the LC circuit's frequency response with the Propeller chip. As mentioned earlier, the small values and relatively high frequencies used with this circuit make it a little finicky. For example, if the capacitor is more than 90° from the loop, the resonant frequency drops, if it is less than 90°, the resonant frequency increases. Also, the various parts will have slightly different characteristics, so it will take some tinkering to set up the circuit so that the resistor divider will cause the LC circuit's output signal to stay below the I/O pin threshold at resonant frequency and creep above it as the frequency sweep gets either further above or below it.

Figure 7-31 shows CalibrateMetalDetector.spin's output after the circuit has been calibrated. The high tick counts on the left actually resemble the Figure 7-26 frequency response plot with a center frequency in the 49.8 MHz neighborhood. The tick counts on the right show that there is still a resonant frequency, but it's shifted up to about 50.6 MHz. Since the circuit inductive loop also experiences increased resistance, it may prevent the circuit from attenuating the signal so that the count measurements spend less time below (or may never quite make it to) zero.

Figure 7-31: Calibrated Metal Detector Response – without metal (left) and with metal (right)

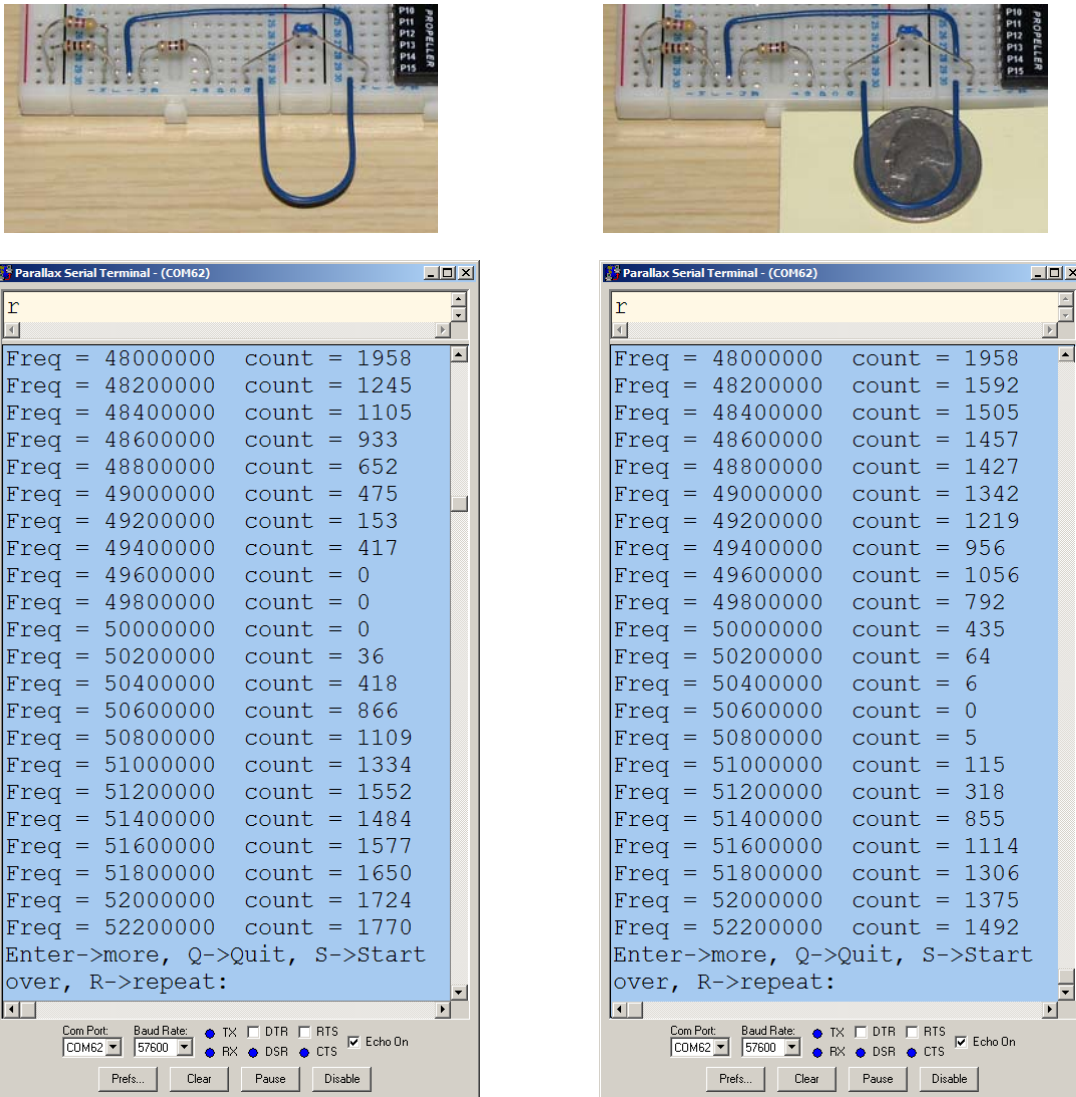

Counter Modules and Circuit Applications Lab

Here is how to manually calibrate your metal detector circuit. Automatic detection is left for the Projects section.

- ✓ Use the Propeller Tool to load CalibrateMetalDetector.spin into EEPROM (F11) and immediately click the Parallax Serial Terminal's *Enable* button. (Remember, you don't even have to wait for the program to finish loading.)
- ✓ When prompted, enter a starting frequency, try 48,000,000.
- ✓ When prompted, enter a frequency step, try 200,000.
- ✓ Compare your display to the left sweep shown in Figure 7-31, looking not so much for your values to match but that the overall profile is similar, which clearly indicates a resonant frequency centered where the count = 0.
- ✓ If your display is showing a clear resonant frequency, try placing a quarter coin directly under, but not quite touching, the metal loop, and press the R key on your keyboard to repeat the same frequency sweep.
- ✓ If your display changes significantly, like the right sweep shown in Figure 7-31, your metal detector apparently doesn't need any further calibration.
- ✓ If you are not seeing clear resonant frequencies, try refining the frequency start and frequency step values so that the sweep clearly indicates the presence and absence of metal.
- ✓ If there is no apparent filter response (either all zeros, or values that are larger without an apparent dip) try the suggestions below.

The circuit may instead need some tuning before it displays responses similar to those in Figure 7-31. If you instead see numbers that are either too high to show zeros or too low (all zeros), the voltage divider likely needs to be adjusted. It is designed to make the output just under the threshold voltage.

- ✓ If you see all zeros, the voltage divider needs to take less away from the signal. First, try successively larger resistors in place of R3. Try 1 k Ω , then 2 k Ω , then 10 k Ω .
- ✓ If the voltage divider is still taking too much away from the signal, disconnect R3 entirely, and instead add an R4 in parallel with R1. Start with a large resistor like 10 k Ω , and work downward again, 2 k Ω , 1 k Ω , and so on. Repeat the frequency sweep between each adjustment until you find a voltage divider that works for your circuit and Propeller chip's threshold voltage.
- ✓ If there is no apparent filter response, in other words, no cluster of low values like in Figure 7-31, you may need to search lower or higher frequencies after adjusting the voltage divider. This involves starting the sweep at lower values, like 46 MHz instead of 48, and using smaller increments, like 100,000 instead of 200,000, and selecting "M" or enter when prompted by Parallax Serial Terminal.
- ✓ Once you are getting good resonant frequencies, can you also discern the metal object's distance, say between 1 mm, 5 mm and 10 mm?

```
'' CalibrateMetalDetector.spin
CON
  _clkmode = xtal1 + pll16x          ' Set up 80 MHz internal clock
  _xinfreq = 5_000_000

  CLS = 16, CR = 13

OBJ

  Debug   : "FullDuplexSerialPlus"
  frq     : "SquareWave"
```

```

PUB Init | count, f, fstart, fstep, c

  'Start FullDuplexSerialPlus
  Debug.start(31, 30, 0, 57600)
  waitcnt(clkfreq*2 + cnt)
  Debug.tx(CLS)

  'Configure ctra module for 50 MHz square wave
  ctra[30..26] := %00010
  ctra[25..23] := %110
  ctra[5..0] := 15
  frq.Freq(0, 15, 50_000_000)
  dira[15]~~

  'Configure ctrb module for negative edge counting
  ctrb[30..26] := %01000
  ctrb[5..0] := 13
  frqb := 1

  c := "S"

  repeat until c == "Q" or c == "q"

  case c
  "S", "s":
    Debug.Str(String("Starting Frequency: "))
    f := Debug.GetDec
    Debug.Str(String("Step size: "))
    fstep := Debug.GetDec
    Debug.tx(String(CR))

  case c
  "S", "s", 13, 10, "M", "m":
    repeat 22
      frq.Freq(0, 15, f)
      count := phsb
      waitcnt(clkfreq/10000 + cnt)
      count := phsb - count
      Debug.Str(String(CR, "Freq = "))
      Debug.Dec(f)
      Debug.Str(String(" count = "))
      Debug.Dec(count)
      waitcnt(clkfreq/20 + cnt)
      f += fstep

    Debug.str(String(CR, "Enter->more, Q->Quit, S->Start over, R->repeat: "))
    c := Debug.rx
    Debug.tx(CR)

  "R", "r":
    f -= (22 * fstep)
    c := "m"

  "Q", "q": quit

  Debug.str(String(10, 13, "Bye!"))

```

Study Time

Questions

- 1) How many counter modules does each cog have, and what are they labeled?
- 2) What terms does this lab use to refer to a counter module's three registers without specifying which counter module is being used? In other words, what generic terms get used to refer to a counter module's three registers?
- 3) What are the three names used to refer to Counter A in Spin Code?
- 4) What are the three names used to refer to Counter B in Spin Code?
- 5) What register gets conditionally added to the PHS register with every clock tick?
- 6) What register can be used to set the condition(s) by which the PHS register gets updated?
- 7) How does the PHS register affect I/O pins with certain bits?
- 8) How does RC decay measurement indicate the state of an environmental variable?
- 9) Is a current limiting resistor necessary with an RC network connected to the Propeller chip?
- 10) It is possible to create an RC circuit that starts at 0 V and accumulates to 5 V during the measurement. What CTRMODE value would have to be used for measuring this kind of circuit?
- 11) How is a counter module's positive detector mode used to measure RC decay?
- 12) Where do the CTRMODE bits reside?
- 13) What do the CTRMODE bits select?
- 14) For RC decay measurements, which fields in the CTR register have to be set?
- 15) What value does the FRQ register have to store to make RC decay measurements?
- 16) What three steps are required to configure a counter module to take RC decay measurements?
- 17) Assuming a counter has been set up to take an RC decay measurement, what has to be done to start the measurement?
- 18) Why can RC decay measurements be taken concurrently?
- 19) How does a counter's interaction with an I/O pin differ between RC decay and D/A conversion applications?
- 20) How does the FRQ register control a duty mode D/A signal?
- 21) What component of the counter module actually controls the I/O pin?
- 22) What purpose does `scale = 16_777_216` serve in `LedDutySweep.spin`?
- 23) How are special purpose registers 8 through 13 addressed?
- 24) What special purpose register can be used to control the value of `ctrb`?
- 25) What special purpose register can be used to set the value of `frqa`?
- 26) What does `myVariable` hold after the command `myVariable := spr[13]` is executed?
- 27) What are two ways of assigning the value stored in `myVar` to `ctrb`?
- 28) How can you affect certain bits within `spr[8]` or `spr[9]`, and why is that useful?
- 29) What element of the counter special purpose registers controls an I/O pin in NCO mode?
- 30) What's the condition for adding FRQ to PHS in NCO mode?
- 31) What ratio does the desired NCO frequency need to be multiplied by to determine the FRQ register value?
- 32) If a counter is set to NCO mode and a program copies a value to the counter's FRQ register, what ratio does the FRQ register need to be multiplied by to determine the frequency?
- 33) If an I/O pin is transmitting an NCO square wave, what are three ways of making it stop?
- 34) Can one cog send two square waves two unrelated frequencies?
- 35) What does a program have to do to change the NCO frequency a counter is transmitting?
- 36) Can a counter module be used to measure signal frequency?
- 37) Are `POSEDGE` and `NEGEDGE` incremented based on the edge of a signal?

7: Counter Modules and Circuit Applications Lab

- 38) There's a command that reads `repeat while phsb[31]` in `BetterCountEdges.spin` in the Faster Edge Detection section on page 155. Would it be possible to substitute a special purpose register in place of `phsb`?
- 39) What range of frequencies can a counter's PLL mode transmit?
- 40) What element from NCO mode does PLL use?
- 41) Unlike NCO mode, PLL mode does not use bit 31 of the PHS register to control the I/O pin. What happens to this signal?
- 42) What are the steps for calculating a PLL frequency given the values stored in the FRQ, PLLDIV, and CLKFRQ registers?
- 43) What are the steps for calculating FRQ and PLLDIV to synthesize a given PLL frequency?

Exercises

- 1) Modify `TestRcDecay.spin` so that it measures rise times instead of decay times.
- 2) Initialize a single ended duty mode D/A conversion to 1 V on P7 using counter module B and the counter modules register names.
- 3) Initialize a single ended duty mode D/A conversion to 1 V on P7 using counter module B and special purpose registers. Be careful with using special purpose register array element that affects DIRA. In order to change just one bit in the entire DIRA register, you can take the existing value stored by the register and OR it with a mask with bit 7 set to 1.
- 4) Calculate the empty cells in Table 7-1 on page 138.
- 5) Assuming the Propeller chip's system clock is running at 20 MHz, write code to send a square wave approximation of the C7 note on P16 that uses Counter B.
- 6) Modify `DoReMi.spin` so that it plays all twelve notes from Table 7-1 on page 138.
- 7) Modify `TwoTonesWithSquareWave.spin` so that it correctly plays the notes with a 2 MHz crystal.
- 8) Modify `IrDetector.spin` so that it takes works on a scale of 0 to 128 instead of 0 to 256.
- 9) Modify `CountEdgeTest.spin` so that it counts positive instead of negative edges.
- 10) Modify `1Hz25PercentDutyCycle.spin` so that it sends the center signal for a servo. This will cause a standard servo to hold a position in the center of its range of motion or a continuous rotation servo to stay still. The signal is a series of 1.5 ms pulses every 20 ms.
- 11) Modify `1Hz25PercentDutyCycle.spin` so that it makes a servo's output sweeps from one extreme of its range of motion to the other in 1.5 seconds. For a 180 degree standard servo, the pulse durations should nominally sweep from 0.5 ms to 2.5 ms and back again. The pulses should still be delivered every 20 ms. In practice, it's good to make sure the servo doesn't attempt to turn beyond its mechanical stoppers. For Parallax standard servos, a safer range would be 0.7 to 2.2 ms.
- 12) Modify `TestDualPwm` so that it sweeps two servos between their opposite extremes of motion over a 1.5 second period.

Projects

- 1) Write a two channel DUTY mode single-ended DAC object that allows you to create and reclaim counter DAC channels (Counter A and Counter B). Each DAC channel should have its own resolution setting in terms of bits. The DAC should support the test code and documentation shown below. If you are going with higher resolutions, remember to leave some room below the lowest and above the highest levels. See `Tips for Setting Duty` on page 132.

Counter Modules and Circuit Applications Lab

TEST CODE

```
Test DAC 2 Channel.spin
2 channel DAC.

OBJ

dac : "DAC 2 Channel"

PUB TestDuty | level

dac.Init(0, 4, 8, 0)           ' Ch0, P4, 8-bit DAC, starts at 0 V
dac.Init(1, 5, 7, 64)        ' Ch1, P5, 7-bit DAC, starts at 1.65 V

repeat
  repeat level from 0 to 256
    dac.Update(0, level)
    dac.Update(1, level + 64) ' DAC output automatically truncated to 128
    waitcnt(clkfreq/100 + cnt)
```

OBJECT DOCUMENTATION

Object "DAC 2 Channel" Interface:

```
PUB Init(channel, ioPin, bits, level)
PUB Update(channel, level)
PUB Remove(channel)
```

Program: 20 Longs
Variable: 2 Longs

```
PUB Init(channel, ioPin, bits, level)
```

Initializes a DAC.

- channel - 0 or 1
- ioPin - Choose DAC I/O pin
- bits - Resolution (8 bits, 10 bits, etc.)
- level - Initial voltage level = $3.3 \text{ V} * \text{level} \div 2^{\text{bits}}$

```
PUB Update(channel, level)
```

Updates the level transmitted by an ADC channel to
 $\text{level} = 3.3 \text{ V} * \text{level} \div 2^{\text{bits}}$

```
PUB Remove(channel)
```

Reclaims the counter module and sets the associated I/O pin to input.

TIPS:

- Define a two long global variable `lsb` array to store the LSB for each DAC.
- The `lsb` variables are the adjustable versions of the `scale` constant in `LedSweepWithSpr.spin`.
- Define each `lsb` array element in the `Init` method using `lsb[channel] := 1 < (32 - bits)`. For example if `bits` is 8, the encode operator sets bit 24 of the `bits` array element. What's the value? `16_777_216`. That's the same as the `scale` constant that was declared for the 8-bit DAC in `LedSweepWithSpr.spin`.

7: Counter Modules and Circuit Applications Lab

- To set a voltage level, use `spr[10 + channel] := level * lsb[channel]`, where `level` is the desired voltage level. For example, if bits is 8 (an 8-bit DAC), then a level of 128 would result in 1.65 V.

- 2) The solution for Exercise 12 (shown below) controls two servos using two counter modules. Each counter module in the `repeat` loop delivers a pulse in the 700 to 2200 μ s range. Then the `waitcnt` command waits for the remaining 20 ms to elapse. The most time the servo pulses currently take is 2200 μ s (2.2 ms). Since the `repeat` loop repeats every 20 ms, that leaves 17.8 ms for pulses to other servos. Modify the program so that it controls two more servos (for a total of four) during that 17.8 ms. Remember that the counters modules run independently, so you will have to insert delays to allow each pair of pulses to complete before moving on to the next pair.

```
{  
  TestDualPWM.spin  
  Demonstrates using two counter modules to send a dual PWM signal.  
  The cycle time is the same for both signals, but the high times are independent of  
  each other.  
}  
  
CON  
  
  _clkmode = xtal1 + pll16x           ' System clock + 80 MHz  
  _xinfreq = 5_000_000  
  
PUB TestPwm | tc, tHa, tHb, t, us    ' <- Add us  
  
  us := clkfreq/1_000_000           ' <- Add  
  
  ctra[30..26] := ctrb[30..26] := %00100 ' Counters A and B + NCO single-ended  
  ctra[5..0] := 4                   ' Set pins for counters to control  
  ctrb[5..0] := 6  
  frqa := frqb := 1                 ' Add 1 to phs with each clock tick  
  
  dira[4] := dira[6] := 1           ' Set I/O pins to output  
  
  tC := 20_000 * us                 ' <- Change Set up cycle time  
  tHa := 700 * us                   ' <- Change Set up high times  
  tHb := 2200 * us                  ' <- Change  
  
  t := cnt                           ' Mark current time.  
  
  repeat tHa from (700 * us) to (2200 * us) ' <- Change Repeat PWM signal  
    phsa := -tHa                     ' Define and start the A pulse  
    phsb := -tHb                     ' Define and start the B pulse  
    t += tC                           ' Calculate next cycle repeat  
    waitcnt(t)                       ' Wait for next cycle
```

- 3) Develop an object that launches a cog and allows other objects to control its duty mode D/A conversion according to the object documentation below. Test this object with a top object that uses a menu system to get D/A values from the user and pass them to control LED brightness.

```
``DualDac.spin  
  
``Provides the two counter module channels from another cog for D/A conversion  
  
How to Use this Object in Your Application
```

Counter Modules and Circuit Applications Lab

1) Declare variables the D/A channel(s). Example:

```
VAR
  ch[2]
```

2) Declare the DualDac object. Example:

```
OBJ
  dac : DualDac
```

3) Call the start method. Example:

```
PUB MethodInMyApp
  ...
  dac.start
```

4) Set D/A outputs. Example:

```
ch[0] := 3000
ch[1] := 180
```

5) Configure the DAC Channel(s). Example:

```
'Channel 0, pin 4, 12-bit DAC, ch[0] stores the DAC value.
dac.Config(0,4,12,@ch[0])
'Since ch[0] was set to 3000 in Step 4, the DAC's P4 output will be
' 3.3V * (3000/4096)

'Channel 1, pin 6, 8-bit DAC, ch[1] stores the DAC value.
dac.Config(1,6,8,@ch[1])
'Since ch[1] was set to 180 in Step 4, the DAC's P6 output will be
' 3.3V * (180/256)
```

6) Methods and features in this object also make it possible to:

- remove a DAC channel
- change a DAC channel's:
 - o I/O pin
 - o Resolution
 - o Control variable address
 - o Value stored by the control variable

See Also

TestDualDac.spin for an application example.

Object "DualDac" Interface:

```
PUB Start : okay
PUB Stop
PUB Config(channel, dacPin, resolution, dacAddress)
PUB Remove(channel)
PUB Update(channel, attribute, value)
```

```
Program:      73 Longs
Variable:    29 Longs
```

```
PUB Start : okay
```

Launches a new D/A cog. Use Config method to set up a dac on a given pin.

```
PUB Stop
```

Stops the DAC process and frees a cog.

7: Counter Modules and Circuit Applications Lab

PUB Config(channel, dacPin, resolution, dacAddress)

Configure a DAC. Blocks program execution until other cog completes command.
channel - 0 = channel 0, 1 = channel 1
dacPin - I/O pin number that performs the D/A
resolution - bits of D/A conversion (8 = 8 bits, 12 = 12 bits, etc.)
dacAddress - address of the variable that holds the D/A conversion level,
a value between 0 and $(2^{\text{resolution}}) - 1$.

PUB Remove(channel)

Remove a channel. Sets channels I/O pin to input and clears the counter module.
Blocks program execution until other cog completes command.

PUB Update(channel, attribute, value)

Update a DAC channel configuration.
Blocks program execution until other cog completes command.
channel - 0 = channel 0, 1 = channel 1
attribute - the DAC attribute to update
0 -> dacPin
1 -> resolution
2 -> dacAddr
3 -> dacValue
value - the value of the attribute to be updated

Appendix A: Object Code Listings

FullDuplexSerialPlus.spin

```

'' From Parallax Inc. Propeller Education Kit - Objects Lab
{{

---

File: FullDuplexSerialPlus.spin
Version: 1.1
Copyright (c) 2008 Parallax, Inc.
See end of file for terms of use.

This is the FullDuplexSerial object v1.1 from the Propeller Tool's Library
folder with modified documentation and methods for converting text strings
into numeric values in several bases.

---

}}

CON
'' Parallax Serial Terminal Control Character Constants
''
HOME      = 1          '' HOME      = 1
CRSRXY    = 2          '' CRSRXY    = 2
CRSRLF    = 3          '' CRSRLF    = 3
CRSRRT    = 4          '' CRSRRT    = 4
CRSRUP    = 5          '' CRSRUP    = 5
CRSRDN    = 6          '' CRSRDN    = 6
BELL      = 7          '' BELL      = 7
BKSP      = 8          '' BKSP      = 8
TAB       = 9          '' TAB       = 9
LF        = 10         '' LF        = 10
CLREOL    = 11         '' CLREOL    = 11
CLRDN     = 12         '' CLRDN     = 12
CR        = 13         '' CR        = 13
CRSRX     = 14         '' CRSRX     = 14
CRSRY     = 15         '' CRSRY     = 15
CLS       = 16         '' CLS       = 16

VAR

long cog                ' cog flag/id

long rx_head            ' 9 contiguous longs
long rx_tail
long tx_head
long tx_tail
long rx_pin
long tx_pin
long rxtx_mode
long bit_ticks
long buffer_ptr

byte rx_buffer[16]     ' transmit and receive buffers
byte tx_buffer[16]

```

Object Code Listings

```
PUB start(rxpin, txpin, mode, baudrate) : okay
{{
  Starts serial driver in a new cog

  rxpin - input receives signals from peripheral's TX pin
  txpin - output sends signals to peripheral's RX pin
  mode - bits in this variable configure signaling
        bit 0 inverts rx
        bit 1 inverts tx
        bit 2 open drain/source tx
        bit 3 ignore tx echo on rx
  baudrate - bits per second

  okay - returns false if no cog is available.
}}

stop
longfill(@rx_head, 0, 4)
longmove(@rx_pin, @rxpin, 3)
bit_ticks := clkfreq / baudrate
buffer_ptr := @rx_buffer
okay := cog := cognew(@entry, @rx_head) + 1

PUB stop

  `` Stops serial driver - frees a cog

  if cog
    cogstop(cog~ - 1)
  longfill(@rx_head, 0, 9)

PUB tx(txbyte)

  `` Sends byte (may wait for room in buffer)

  repeat until (tx_tail <> (tx_head + 1) & $F)
  tx_buffer[tx_head] := txbyte
  tx_head := (tx_head + 1) & $F

  if rxtx_mode & %1000
    rx

PUB rx : rxbyte

  `` Receives byte (may wait for byte)
  `` rxbyte returns $00..$FF

  repeat while (rxbyte := rxcheck) < 0

PUB rxflush

  `` Flush receive buffer

  repeat while rxcheck => 0

PUB rxcheck : rxbyte

  `` Check if byte received (never waits)
  `` rxbyte returns -1 if no byte received, $00..$FF if byte

  rxbyte--
  if rx_tail <> rx_head
```

```

    rxbyte := rx_buffer[rx_tail]
    rx_tail := (rx_tail + 1) & $F
PUB rxtime(ms) : rxbyte | t
    '' Wait ms milliseconds for a byte to be received
    '' returns -1 if no byte received, $00..$FF if byte

    t := cnt
    repeat until (rxbyte := rxcheck) => 0 or (cnt - t) / (clkfreq / 1000) > ms
PUB str(stringptr)
    '' Send zero terminated string that starts at the stringptr memory address

    repeat strsize(stringptr)
        tx(byte[stringptr++])
PUB getstr(stringptr) | index
    '' Gets zero terminated string and stores it, starting at the stringptr memory address
    index~
    repeat until ((byte[stringptr][index++] := rx) == 13)
    byte[stringptr][--index]~
PUB dec(value) | i
    '' Prints a decimal number

    if value < 0
        -value
        tx("--")

    i := 1_000_000_000

    repeat 10
        if value => i
            tx(value / i + "0")
            value /= i
            result~~
        elseif result or i == 1
            tx("0")
        i /= 10
PUB GetDec : value | tempstr[11]
    '' Gets decimal character representation of a number from the terminal
    '' Returns the corresponding value

    GetStr(@tempstr)
    value := StrToDec(@tempstr)
PUB StrToDec(stringptr) : value | char, index, multiply
    '' Converts a zero terminated string representation of a decimal number to a value

    value := index := 0
    repeat until ((char := byte[stringptr][index++]) == 0)
        if char => "0" and char <= "9"
            value := value * 10 + (char - "0")
        if byte[stringptr] == "-"
            value := - value
PUB bin(value, digits)

```

Object Code Listings

```
    `` Sends the character representation of a binary number to the terminal.

value <<= 32 - digits
repeat digits
    tx((value <= 1) & 1 + "0")

PUB GetBin : value | tempstr[11]

    `` Gets binary character representation of a number from the terminal
    `` Returns the corresponding value

    GetStr(@tempstr)
    value := StrToBin(@tempstr)

PUB StrToBin(stringptr) : value | char, index

    `` Converts a zero terminated string representaton of a binary number to a value

value := index := 0
repeat until ((char := byte[stringptr][index++]) == 0)
    if char => "0" and char =< "1"
        value := value * 2 + (char - "0")
if byte[stringptr] == "-"
    value := - value

PUB hex(value, digits)

    `` Print a hexadecimal number

value <<= (8 - digits) << 2
repeat digits
    tx(lookupz((value <= 4) & $F : "0".."9", "A".."F"))

PUB GetHex : value | tempstr[11]

    `` Gets hexadecimal character representation of a number from the terminal
    `` Returns the corresponding value

    GetStr(@tempstr)
    value := StrToHex(@tempstr)

PUB StrToHex(stringptr) : value | char, index

    `` Converts a zero terminated string representaton of a hexadecimal number to a value

value := index := 0
repeat until ((char := byte[stringptr][index++]) == 0)
    if (char => "0" and char =< "9")
        value := value * 16 + (char - "0")
    elseif (char => "A" and char =< "F")
        value := value * 16 + (10 + char - "A")
    elseif (char => "a" and char =< "f")
        value := value * 16 + (10 + char - "a")
if byte[stringptr] == "-"
    value := - value

DAT

*****
* Assembly language serial driver *
*****

                                org
```

```

,
,
, Entry
,
entry          mov     t1,par           'get structure address
               add     t1,#4 << 2      'skip past heads and tails

               rdlong  t2,t1           'get rx_pin
               mov     rxmask,#1
               shl    rxmask,t2

               add     t1,#4           'get tx_pin
               rdlong  t2,t1
               mov     txmask,#1
               shl    txmask,t2

               add     t1,#4           'get rxtx_mode
               rdlong  rxtxmode,t1

               add     t1,#4           'get bit_ticks
               rdlong  bitticks,t1

               add     t1,#4           'get buffer_ptr
               rdlong  rxbuff,t1
               mov     txbuff,rxbuff
               add     txbuff,#16

               test    rxtxmode,##%100 wz 'init tx pin according to mode
               test    rxtxmode,##%010 wc
               or     outa,txmask
               or     dira,txmask

               mov     txcode,#transmit 'initialize ping-pong multitasking
,
,
, Receive
,
receive        jmpret  rxcode,txcode    'run chunk of tx code, then return

               test    rxtxmode,##%001 wz 'wait for start bit on rx pin
               test    rxmask,ina      wc
               jmp     #receive

               mov     rxbits,#9       'ready to receive byte
               mov     rxcnt,bitticks
               shr    rxcnt,#1
               add     rxcnt,cnt

:bit           add     rxcnt,bitticks    'ready next bit period

:wait         jmpret  rxcode,txcode    'run chunk of tx code, then return

               mov     t1,rxcnt        'check if bit receive period done
               sub     t1,cnt
               cmps   t1,#0            wc
               jmp     #:wait

               test    rxmask,ina      wc 'receive bit on rx pin
               rcr    rxdata,#1
               djnz   rxbits,#:bit

               shr    rxdata,#32-9     'justify and trim received byte
               and    rxdata,##$FF
               test    rxtxmode,##%001 wz 'if rx inverted, invert byte

```

Object Code Listings

```

        if_nz          xor      rxdata, #$FF
                        rdlong  t2, par          'save received byte and inc head
                        add     t2, rxbuff
                        wrbyte  rxdata, t2
                        sub     t2, rxbuff
                        add     t2, #1
                        and     t2, #$0F
                        wrlong  t2, par
,
,
' Transmit
transmit          jmpret   txcode, rxcode      'run chunk of rx code, then return
                        mov     t1, par          'check for head <> tail
                        add     t1, #2 << 2
                        rdlong  t2, t1
                        add     t1, #1 << 2
                        rdlong  t3, t1
                        cmp     t2, t3          wz
        if_z          jmp     #transmit
                        add     t3, txbuff      'get byte and inc tail
                        rdbyte  txdata, t3
                        sub     t3, txbuff
                        add     t3, #1
                        and     t3, #$0F
                        wrlong  t3, t1
                        or      txdata, #$100   'ready byte to transmit
                        shl     txdata, #2
                        or      txdata, #1
                        mov     txbits, #11
                        mov     txcnt, cnt
:bit              test     rxtxmode, #%100    wz          'output bit on tx pin
                  test     rxtxmode, #%010    wc          'according to mode
        if_z_and_c   xor     txdata, #1
                  shr     txdata, #1          wc
        if_z         muxc   outa, txmask
        if_nz        muxnc  dira, txmask
                  add     txcnt, bitticks     'ready next cnt
:wait             jmpret   txcode, rxcode      'run chunk of rx code, then return
                  mov     t1, txcnt          'check if bit transmit period done
                  sub     t1, cnt
                  cmps    t1, #0            wc
        if_nc        jmp     #:wait
                  djnz    txbits, #:bit      'another bit to transmit?
,
,
' Uninitialized data
t1              res     1
t2              res     1
t3              res     1

```



```

rxtxmode      res    1
bitticks      res    1

rxmask        res    1
rxbuff        res    1
rxdata        res    1
rxbits        res    1
rxcnt         res    1
rxcode        res    1

txmask        res    1
txbuff        res    1
txdata        res    1
txbits        res    1
txcnt         res    1
txcode        res    1

```

```
{{
```

TERMS OF USE: MIT License

Permission is hereby granted, free of charge, to any person obtaining a copy of this software and associated documentation files (the "Software"), to deal in the Software without restriction, including without limitation the rights to use, copy, modify, merge, publish, distribute, sublicense, and/or sell copies of the Software, and to permit persons to whom the Software is furnished to do so, subject to the following conditions:

The above copyright notice and this permission notice shall be included in all copies or substantial portions of the Software.

THE SOFTWARE IS PROVIDED "AS IS", WITHOUT WARRANTY OF ANY KIND, EXPRESS OR IMPLIED, INCLUDING BUT NOT LIMITED TO THE WARRANTIES OF MERCHANTABILITY, FITNESS FOR A PARTICULAR PURPOSE AND NONINFRINGEMENT. IN NO EVENT SHALL THE AUTHORS OR COPYRIGHT HOLDERS BE LIABLE FOR ANY CLAIM, DAMAGES OR OTHER LIABILITY, WHETHER IN AN ACTION OF CONTRACT, TORT OR OTHERWISE, ARISING FROM, OUT OF OR IN CONNECTION WITH THE SOFTWARE OR THE USE OR OTHER DEALINGS IN THE SOFTWARE.

```
}}
```

SquareWave.spin

```

'' From Parallax Inc. Propeller Education Kit - Counters & Circuits Lab
'' SquareWave.spin

'' Can be used to make either or both of a given cog's counter modules transmit square
'' waves.

PUB Freq(Module, Pin, Frequency) | s, d, ctr

'' Determine CTR settings for synthesis of 0..128 MHz in 1 Hz steps
'',
'' in:   Pin = pin to output frequency on
''       Freq = actual Hz to synthesize
'',
'' out:  ctr and frq hold ctra/ctrb and frqa/frqb values
''
'' Uses NCO mode %00100 for 0..499_999 Hz

```

Object Code Listings

```
`` Uses PLL mode %00010 for 500_000..128_000_000 Hz
``

Frequency := Frequency #> 0 <# 128_000_000      'limit frequency range

if Frequency < 500_000                          'if 0 to 499_999 Hz,
  ctr := constant(%00100 << 26)                '..set NCO mode
  s := 1                                         '..shift = 1

else                                              'if 500_000 to 128_000_000 Hz,
  ctr := constant(%00010 << 26)                '..set PLL mode
  d := >|((Frequency - 1) / 1_000_000)         'determine PLLDIV
  s := 4 - d                                    'determine shift
  ctr |= d << 23                               'set PLLDIV

spr[10 + module] := fraction(Frequency, CLKFREQ, s) 'Compute frqa/frqb value
ctr |= Pin                                           'set PINA to complete ctra/ctrb value
spr[8 + module] := ctr

dira[pin]~~

PUB NcoFrqReg(frequency) : frqReg
{{
Returns frqReg = frequency × (232 ÷ clkfreq) calculated with binary long
division. This is faster than the floating point library, and takes less
code space. This method is an adaptation of the CTR object's fraction
method.
}}
  frqReg := fraction(frequency, clkfreq, 1)

PRI fraction(a, b, shift) : f

if shift > 0                                     'if shift, pre-shift a or b left
  a <<= shift                                    'to maintain significant bits while
if shift < 0                                     'insuring proper result
  b <<= -shift

repeat 32                                       'perform long division of a/b
  f <<= 1
  if a => b
    a -= b
    f++
  a <<= 1
```

Appendix B: Study Solutions

I/O and Timing Basics Lab Study Solutions

I/O and Timing Question Solutions

- 1) Eight
- 2) 32 KB
- 3) The Propeller chip's supply voltage is 3.3 V. When an I/O pin is high, the Propeller chip internally connects the I/O pin to its 3.3 V supply, and when it's low, it's connected to GND or 0 V.
- 4) Spin code is stored in the Propeller chip's global RAM, and a cog running an interpreter program fetches and executes the codes.
- 5) Instead of executing Spin codes that get fetched from global RAM and executed, machine codes generated by assembly language get stored in a cog's 2 KB of RAM, and are executed directly by the cog.
- 6) There are a lot of ways to answer this. The most condensed and Propeller-centric answer would be that a method is a block of code with a minimum of a declared access rule and name; whereas, an object is a building block comprised of all the code in a .spin file. Every object also contains one or more methods.
- 7) It's the object that provides a starting point for a given application that gets loaded into the Propeller chip's RAM. Although it's not required, top objects often organize and orchestrate the application's objects.
- 8) Each bit in `dira` sets the direction (output or input) of an I/O pin for a given cog. Each bit in `outa` sets the output state (on or off) for a given cog, provided the corresponding bit in the `dira` register is set to output.
- 9) There were four different types of conditions. The number of repetitions was placed to the right of the `repeat` command to specify how many times the loop gets repeated. The `while` condition specified to keep repeating a loop while a condition is true. The `until` condition was used to keep repeating code until a certain condition occurs. Finally, a variable was incremented each time through a `repeat` loop, from a certain value, to a certain value.
- 10) `clkfreq`
- 11) They need to be below and indented from the `repeat` command to be part of the loop. The next command following the `repeat` command that is at the same or less level of indentation is not part of the `repeat` loop, nor is any command that follows it, regardless of its indentation.
- 12) The `waitcnt` command's target value was typically calculated by adding some fraction of `clkfreq` to the `cnt` register. Then, the `waitcnt` waits until the `cnt` register exceeds the `waitcnt` value.
- 13) `_xinfreq` stores the input oscillator's frequency; whereas, in this lab `_clkmode` was used to define the Propeller chip's crystal feedback and PLL multiplier settings. For more information, look these terms up in the Propeller Manual.
- 14) It multiplies the frequency by a value. Multiplier options are 1, 2, 4, 8, or 16.
- 15) The `clkfreq` constant adjusts with the Propeller chip's system clock; whereas, a constant value used for delays will result in delays that change with the system clock settings.
- 16) An external crystal.
- 17) The `dira` and `outa` registers control direction and output state respectively. If an I/O pin is set to input, the `ina` register's values will update at runtime when an `ina` command is issued, returning 1 or 0 for each bit depending on voltage applied to the corresponding I/O pin.

Study Solutions

Voltages applied to an I/O pin above 1.65 V cause a 1 to be returned. Voltages below 1.65 V cause a 0 to be returned.

- 18) A single value in between the square brackets to the right of `dira/outa/ina` refers to a single bit in the register. Two values separated by two dots refer to a contiguous group of bits.
- 19) `%`, the binary number indicator.
- 20) The I/O pin is set to input, so it only monitors the voltage applied to the pin and stores a 1 in its `ina` bit if the voltage is above 1.65 V, or a 0 if it is below 1.65 V. As an input, the pin has no effect on external circuits.
- 21) Zero.
- 22) Assign-Equals `:=`, Post-Set `~~`, Post-Clear `~`, Bitwise NOT `!`, Limit Maximum `<#`, Limit Minimum `#>`, Pre- and Post-Increment `++`, Pre- and Post-Decrement `--`, Assign Shift Right `>>=`, and Assign Shift Left `<<=`.
- 23) Is Equal `==`, Is Not Equal `<>`, Is Less Than `<`, Is Greater Than `>`, Is Equal or Less `=<`, Is Equal or Greater `=>`.
- 24) `:=` is Assign-equals; whereas `==` is the comparison Is Equal. The result of `:=` assigns the value of the operand on the right to the operand on the left. The result of `==` simply compares two values, and returns -1 if they are equal and 0 if they are not.
- 25) No, they are not necessary, though they can be useful. In this lab, the value returned by `ina` for a given bit was either 1 or 0, which worked fine for `if` blocks because the code would be executed if the condition is non-zero, or not executed if it's zero (-1 is non-zero).
- 26) Global and local. Global variables are declared in an object's `VAR` section. Local variables are only in use by a method as it executes.
- 27) The three sizes of variable are byte (0 to 255), word (0 to 65535) and long (-2,147,483,648 to 2,147,483,647). Local variables are automatically long-size, whereas global variables can be declared as byte, word, or long.
- 28) A pipe `|` character is used to declare local variables to the right of the method declaration. To the right of the pipe, more than one variable name may be declared, separated by commas.

I/O and Timing Basics Lab Exercise Solutions

- 1) Solution:

```
outa[8..12] := dira[8..12] := %1111
```
- 2) Solution:

```
dira[9] := outa[9] := 1
outa[13..15] := %000
dira[13..15] := %111
```
- 3) Solution:

```
dira[0..8] := %111000000
```
- 4) Solution:

```
outa[8]~~
outa[9]~
repeat
  !outa[8..9]
  waitcnt(clkfreq/100 + cnt)
```
- 5) Solution:

```
repeat
  outa[0..7] != ina[8..15]
```

6) Solution:

```
CON
  _xinfreq = 5_000_000
  _clkmode = xtal1 + pll2x
```

7) Solution:

```
waitcnt(clkfreq*5 + cnt)
```

8) Solution:

```
outa[5..11]~~
waitcnt(clkfreq*3 + cnt)
outa[5..11] := %1010101
```

9) Solution:

```
PUB LightsOn | counter
  dira[4..9] := %111111
  repeat counter from 4 to 9
    outa[counter] := 1
    waitcnt(clkfreq + cnt)
  repeat
```

10) Solution:

```
PUB method
  dira[27] := 1
  repeat
    if ina[0]
      outa[27]~~
      waitcnt(clkfreq*5 + cnt)
    outa[27] ~
```

11) Solution:

```
PUB SecondCountdown
  dira[9..4]~~
  repeat outa[9..4] from 59 to 0
    waitcnt(clkfreq + cnt)
```

12) Solution:

```
PUB SecondCountdown
  dira[9..4]~~
  repeat
    repeat outa[9..4] from 59 to 0
      waitcnt(clkfreq + cnt)
```

13) Solution:

```
PUB PushTwoStart
  dira[4]~~
  repeat until ina[23..21] == %101
    outa[4]~~
```

14) Solution:

```
PUB PushTwoCountdown
  dira[9..4]~~
  repeat until ina[23..21] == %101
    outa[4]~~
    repeat outa[9..4] from 59 to 0
      waitcnt(clkfreq + cnt)
```

I/O and Timing Basics Lab Project Solutions

1) Example solution:

```
''File: NonActuatedStreetlights.spin
''A high speed prototype of a N/S E/W streetlight controller.

PUB StreetLights

  dira[9..4]~~                ' Set LED I/O pins to output

  repeat                      ' Main loop

    outa[4..9] := %001100      ' N/S green, E/W red
    waitcnt(clkfreq * 8 + cnt) ' 8 s
    outa[4..9] := %010100      ' N/S yellow, E/W red
    waitcnt(clkfreq * 3 + cnt) ' 3 s
    outa[4..9] := %100001      ' N/S red, E/W green
    waitcnt(clkfreq * 8 + cnt) ' 8 s
    outa[4..9] := %100010      ' N/S red, E/W yellow
    waitcnt(clkfreq * 3 + cnt) ' 3 s
```

2) Example Solution:

```
''File: ActuatedStreetlightsEW.spin
''A high speed prototype of a N/S E/W streetlight controller.

PUB StreetLightsActuatedEW

  dira[9..4]~~                ' Set LED I/O pins to output

  repeat                      ' Main loop

    outa[4..9] := %001100      ' N/S green, E/W red
    repeat until ina[21]       ' Car on E/W street
    waitcnt(clkfreq * 3 + cnt) ' 3 s
    outa[4..9] := %010100      ' N/S yellow, E/W red
    waitcnt(clkfreq * 3 + cnt) ' 3 s
    outa[4..9] := %100001      ' N/S red, E/W green
    waitcnt(clkfreq * 8 + cnt) ' 8 s
    outa[4..9] := %100010      ' N/S red, E/W yellow
    waitcnt(clkfreq * 3 + cnt) ' 3 s
```

3) Example solution:

```
''File: LedFrequenciesWithoutCogs.spin
''Experience the discomfort of developing processes that could otherwise run
''independently in separate cogs. In this example, LEDs blink at 1, 2, 3, 5,
''7, and 11 Hz.

CON

  _xinfreq = 5_000_000          ' 5 MHz external crystal
  _clkmode = xtall + pll16x     ' 5 MHz crystal multiplied + 80 MHz

  T_LED_P4 = 2310               ' Time increment constants
  T_LED_P5 = 1155
  T_LED_P6 = 770
  T_LED_P7 = 462
  T_LED_P8 = 330
  T_LED_P9 = 210

PUB Blinks | T, dT, count

  dira[9..4]~~                ' Set LED I/O pins to output
```

```

    dT := clkfreq / 4620          ' Set time increment
    T := cnt                     ' Mark current time

repeat                          ' Main loop

    T += dT                     ' Set next cnt target
    waitcnt(T)                  ' Wait for target

    if ++count == 2310          ' Reset count every 2310
        count := 0

    ' Update each LED state at the correct count.
    if count // T_LED_P4 == 0
        !outa[4]
    if count // T_LED_P5 == 0
        !outa[5]
    if count // T_LED_P6 == 0
        !outa[6]
    if count // T_LED_P7 == 0
        !outa[7]
    if count // T_LED_P8 == 0
        !outa[8]
    if count // T_LED_P9 == 0
        !outa[9]

```

4) Example solution:

```

''File: MinuteSet.spin
''Emulates buttons that set alarm clock time.

PUB SetTimer | counter, divide

    dira[9..4]~~                ' Set LED I/O pins to output

repeat                          ' Main loop

    'Delay for 1 ms.
    waitcnt(clkfreq/1000 + cnt)  ' Delay 1 ms

    {If a button is pressed...
    NOTE: Resetting the counter to -1 makes it possible to rapidly press
    and release the button and advance the minute display without the any
    apparent delay.}
    if ina[21] or ina[23]        ' if a button is pressed
        counter++                ' increment counter
    else                          ' otherwise
        counter := -1            ' set counter to -1

    'Reset minute overflows
    if outa[9..4] == 63          ' If 0 rolls over to 63
        outa[9..4] := 59        ' reset to 59
    elseif outa[9..4] == 60     ' else if 59 increments to 60
        outa[9..4] := 0        ' set to 0

    'Set counter ms time slice duration
    if counter > 2000            ' If counter > 2000 (10 increments)
        divide := 50            ' 50 ms between increments
    else                          ' otherwise
        divide := 200           ' 200 ms between increments

    'If one of the ms time slices has elapsed
    if counter // divide == 0    ' if a time slice has elapsed
        if ina[21]               ' if P21 pushbutton is pressed
            outa[9..4]++         ' increment outa[9..4]

```

Study Solutions

```
elseif ina[23]          ; else if P23 pushbutton is pressed
    outa[9..4]--        ; decrement outa[9..4]
```

5) Example solution:

```
''File: SecondCountdownTimer.spin
''Emulates buttons that set alarm clock time.

PUB SetTimerWiCountdown | counter, divide, T

    dira[9..4]~~        ; Set LED I/O pins to output
    repeat              ; Main loop

        repeat until ina[22] ; Break out if

            'Delay for 1 ms.
            waitcnt(clkfreq/1000 + cnt) ; Delay 1 ms

            {If a button is pressed...
            NOTE: Resetting the counter to -1 makes it possible to rapidly press
            and release the button and advance the minute display without the any
            apparent delay.}

            if ina[21] or ina[23] ; if a button is pressed
                counter++ ; increment counter
            else ; otherwise
                counter := -1 ; set counter to -1

            'Reset minute overflows
            if outa[9..4] == 63 ; If 0 rolls over to 63
                outa[9..4] := 59 ; reset to 59
            elseif outa[9..4] == 60 ; else if 59 increments to 60
                outa[9..4] := 0 ; set to 0

            'Set counter ms time slice duration
            if counter > 2000 ; If counter > 2000 (10 increments)
                divide := 50 ; 50 ms between increments
            else ; otherwise
                divide := 200 ; 200 ms between increments

            'If one of the ms time slices has elapsed
            if counter // divide == 0 ; if a time slice has elapsed
                if ina[21] ; if P21 pushbutton is pressed
                    outa[9..4]++ ; increment outa[9..4]
                elseif ina[23] ; else if P23 pushbutton is pressed
                    outa[9..4]-- ; decrement outa[9..4]

            T := cnt ; Mark the time
            repeat while outa[9..4] ; Repeat while outa[9..4] is not 0
                T += clkfreq ; Calculate next second's clk value
                waitcnt(T) ; Wait for it...
                outa[9..4]-- ; Decrement outa[9..4]
```

Methods and Cogs Lab Study Solutions

Methods and Cogs Lab Question Solutions

- 1) It automatically returns program control and a value to the method call.
- 2) That depends on how many parameter local variables appear in the method definitions parameter list. The method call has to pass one value to each parameter.
- 3) One.
- 4) If no value is specified, the method returns the value stored in its result variable, which is initialized to zero when the method gets called. An alias name for the result variable can be declared to the right of the parameter, following a colon. For example, a method declared `PUB MyMethod(parameter1, parameter2) : returnAlias` would return the value stored by the `returnAlias` variable.
- 5) A method call and the address of a variable array that will serve as the cog's stack.
- 6) Cog 0 uses unused RAM for its stack; whereas other cogs have to have stack space declared in the `VAR` block.
- 7) The `cognew` command automatically launches a method into the next available cog and returns the cog number; whereas `coginit` allows you to specify which cog a method gets launched into.
- 8) Use the `cogstop` command.
- 9) Return address information, return result, parameter values, and local variables.
- 10) Values are stored in RAM addresses that follow the last local variable. Values are pushed to and popped from these memory locations to support calculations and loop operations.
- 11) A second set of values (return address, return result...) is added to the stack. When the method returns, the stack space is reclaimed.
- 12) Declare way more stack space than you think you'll need.
- 13) The `cognew` command returns the value of the cog the method was launched into.
- 14) Yes, it was demonstrated in the Cog ID Indexing section.

Methods and Cogs Lab Exercise Solutions

- 1) Example:

```
PUB SquareWave(pin, tHigh, tCycle) : success | tC, tH
```
- 2) Example:

```
yesNo := SquareWave(24, clkfreq/2000, clkfreq/100)
```
- 3) Example:

```
VAR
    swStack[40]
```
- 4) Example:

```
VAR
    byte swCog
```
- 5) In this case, `swCog` will store the result of `cognew` (success or not). See the Propeller Manual for details.

```
swCog := cognew(SquareWave(24, clkfreq/2000, clkfreq/100), @swStack)
```
- 6) Example:

```
swCog := coginit(5, SquareWave(24, clkfreq/2000, clkfreq/100), @swStack)
```

Study Solutions

7) Example:

```
VAR
    long swStack[120]
```

8) Example:

```
VAR
    byte swCog[3]
```

9) Example:

```
swCog[0] := cognew(SquareWave(5, clkfreq/20, clkfreq/10), @swStack)
swCog[1] := cognew(SquareWave(6, clkfreq/100, clkfreq/5), @swStack[40])
swCog[2] := cognew(SquareWave(9, clkfreq/2000, clkfreq/500), @swStack[80])
```

Methods and Cogs Lab Project Solutions

1) Example method:

```
PUB SquareWave(pin, tHigh, tCycle) : success | tH, tC
```

```
    outa[pin]~
    dira[pin]~~

    tC := cnt

    repeat
        outa[pin]~~
        tH := tC + tHigh
        tC += tCycle
        waitcnt(tH)
        outa[pin]~
        waitcnt(tC)
```

2) Example solution:

```
''File: TestSquareWaveMethod.spin

CON

    _xinfreq = 5_000_000
    _clkmode = xtal1 + pll16x

VAR

    long swStack[120]
    byte swCog[3]

PUB TestSquareWave

    swCog[0] := cognew(SquareWave(5, clkfreq/20, clkfreq/10), @swStack)
    swCog[1] := cognew(SquareWave(6, clkfreq/100, clkfreq/5), @swStack[40])
    swCog[2] := cognew(SquareWave(9, clkfreq/2000, clkfreq/500), @swStack[80])
```

3) No solution, just have fun experimenting!

Objects Lab Study Solutions

Objects Lab Question Solutions

- 1) A method call in the same object just uses the method's name. A call to a method in another object uses a nickname that was given to the object in **OBJ** block, then a dot, then the method's name. So the difference is instead of just using `MethodName`, it's `ObjectName.MethodName`.
- 2) No. Parameters are passed and returned the same way they would in a method in the same object.
- 3) The object that's getting declared has to either be in the same folder with the object that's declaring it, or in the same folder with the Propeller Tool software.
- 4) In the Object View pane, which can be viewed in the Object Info window (F8), and also in the upper-left corner of the Propeller Tool software's Explorer pane.
- 5) Two apostrophes can be placed to the left of a comment that should appear in the Propeller Tool software's documentation view. A block of documentation text can be defined with double-braces `{{documentation comments}}`.
- 6) By clicking the Documentation radio button above the code.
- 7) Method names `Start` and `Stop`.
- 8) Declare multiple copies of the object in the **OBJ** section, and call each of their `Start` methods.
- 9) If the process the object manages is already running in another cog, the call to the `Stop` method shuts it down before launching the process into a new cog.
- 10) By clicking on characters in the Propeller Tool Character Chart.
- 11) Public methods are declared with **PUB**, private with **PRI**. Public methods can be called by commands in other objects; private methods can only be called from within the same object.
- 12) Declare multiple copies of the same object by declaring an object array. For example, the command `nickname[3] : ObjectName` declares three copies of `ObjectName`, `nickname[0]`, `nickname[1]`, and `nickname[2]`. Note that it doesn't actually make extra copies of the object code. Each instance still uses the same copy of the Spin code that is loaded into the Propeller chip.
- 13) They are stored in the same folder with the Propeller Tool software .exe file.
- 14) To view the Object Interface information, click the Documentation radio button, and the Propeller Tool software automatically generates that information and displays it along with the documentation comments.
- 15) In the Program codes.
- 16) Given a start address in RAM, the `FullDuplexSerial` object's `Str` method fetches and transmits characters until it fetches a zero.
- 17) Documentation comments should explain what the method does, its parameters (if any) and its return value.
- 18) Character strings and other lists of values can be stored in an object's **DAT** section.
- 19) They are used to (1) declare variables in **VAR** blocks, (2) declare list element sizes in **DAT** blocks, and (3) return values stored at given addresses within **PUB** and **PRI** blocks.
- 20) The `Float` object uses `FAdd` to add two floating-point numbers.
- 21) `FloatString`.
- 22) No, the Propeller Tool packs 1.5 into floating-point format at compile time and stores it with the program byte codes. The command `a := 1.5` copies the value into a variable.
- 23) A variable's address get passed to an object method's parameter with the `@` operator. Instead of this format: `ObjectName.MethodName(variableName)`, use the following format: `ObjectName.MethodName(@variableName)`.

Study Solutions

- 24) An object can declare a list of variables in a certain order, and then assign them each values that the object will use. Then, the address of the first variable in the list can be passed to the object's method.
- 25) The object will use either `long`, `word` or `byte` and the address. For example, if the address is passed to a parameter named `address`, the object can access the value stored by the variable with `long[address][0]` or just `long[address]`. To store the variable declared immediately to the right of the variable at `address`, `long[address][1]` can be used. For the second variable to the right, `long[address][2]` can be used, and so on.
- 26) Yes. This can be useful at times, because the parent object can simply update a variable value, and an object running another process will automatically update based on that value.
- 27) Yes. This comes in handy when a process is running in another cog, and the parent object needs one or more of its variables to be automatically updated by the other process.

Objects Lab Exercise Solutions

- 1) Solution:
`led : "MyLedObject"`
- 2) Solution:
`led.On(4)`
- 3) With the aid of the Propeller Tool software's Character Chart: 102, 32, 61, 32, 84, 22.
- 4) Solution:
`PRI calcArea(height, width) : area`
- 5) Solution:
`Uart[5] : "FullDuplexSerial"`
- 6) Solution:
`uart[2].str(String("Hello!!!"))`
- 7) Solution:
`DAT
 Hi byte Hello!!! , 0`
- 8) Solution:
`c := f.fmul(d, pi)`
- 9) Solution:
`address := fst(c)`

Objects Lab Project Solutions

- 1) Example Object:

```
{  
  Bs2IoLite.spin  
  
  This object features method calls similar to the PBASIC commands for the BASIC  
  Stamp  
  2 microcontroller, such as high, low, in0 through in15, toggle, and pause.  
  
}  
  
PUB high(pin)  
  'Make pin output-high.
```

```

    outa[pin]~~
    dira[pin]~~

PUB low(pin)
  ``Make pin output-low

    outa[pin]~
    dira[pin]~~

PUB in(pin) : state
  {{Return the state of pin.
  If pin is an output, state reflects the
  output signal. If pin is an input, state will be 1 if the voltage
  applied to pin is above 1.65 V, or 0 if it is below.}}

    state := ina[pin]

PUB toggle(pin)
  ``Change pin's output state (high to low or low to high).

    !outa[pin]

PUB pause(ms) | time
  ``Make the program pause for a certain number of ms. This applies to
  ``the cog making the call. Other cogs will not be affected.

    time := ms * (clkfreq/1000)
    waitcnt(time + cnt)

```

- 2) For modifying Parallax Serial Terminal, save a copy of PropellerCOM under a new name, such as TestPropellerStack.ht. Change the Parallax Serial Terminal's *Baud Rate* from 57600 to 19200.

The modified Stack Length Demo object below has several changes. The code below the Code/Object Being Tested for Stack Usage heading was replaced with the Blinker object code. The Blinker object's stack variable array was increased to 32 longs. Then, in the Temporary Code to Test Stack Usage section, the `start` method call was modified to work with the Blinker object.

Run the modified Stack Length Demo object below to test the stack required by the Blink method for launching into another cog. After the Propeller Tool has completed its download, you will have 2 seconds to connect Parallax Serial Terminal. The result should be 9.

Since the result is 9 instead of 10 predicted by the Methods lab, this project exposes an error in the Methods lab's section entitled: "How Much Stack Space for a Method Launched into a Cog?" The `time` local variable was removed from the `Blink` method, but not from the discussion of how much stack space the `Blink` method requires.

```

{{
StackLengthDemoModified.spin

This is a modified version of Stack Length Demo object from the Propeller Library
Demos folder. This modified version tests the Propeller Education Kit Objects
lab's Blinker object's Blink method for stack space requirements. See Project #2
in the Objects lab for more information.
}}
```

Study Solutions

```
{.....}
Temporary Code to Test Stack Usage
{.....}

CON
  _clkmode      = xtall1 + pll16x      'Use crystal * 16 for fast serial
  _xinfreq      = 5_000_000          'External 5 MHz crystal on XI & XO

OBJ
  Stk :      "Stack Length" 'Include Stack Length Object

PUB TestStack
  Stk.Init(@Stack, 32)      'Initialize reserved Stack space (reserved below)
  start(4, clkfreq/10, 20) 'Exercise code/object under test
  waitcnt(clkfreq * 3 + cnt) 'Wait ample time for max stack usage
  Stk.GetLength(30, 19200) 'Transmit results serially out P30 at 19,200 baud

{.....}
Code/Object Being Tested for Stack Usage
{.....}

{{
File: Blinker.spin
Example cog manager for a blinking LED process.

SCHEMATIC

---





---

}}

VAR
  long  stack[32]      'Cog stack space
  byte  cog            'Cog ID

PUB Start(pin, rate, reps) : success
  {{Start new blinking process in new cog; return True if successful.

Parameters:
  pin - the I/O connected to the LED circuit → see schematic
  rate - On/off cycle time is defined by the number of clock ticks
  reps - the number of on/off cycles
  }}
  Stop
  success := (cog := cognew(Blink(pin, rate, reps), @stack) + 1)

PUB Stop
  ''Stop blinking process, if any.

  if Cog
    cogstop(Cog~ - 1)

PUB Blink(pin, rate, reps)
  {{Blink an LED circuit connected to pin at a given rate for reps repetitions.

Parameters:
  pin - the I/O connected to the LED circuit → see schematic
```

```

rate - On/off cycle time is defined by the number of clock ticks
reps - the number of on/off cycles
}}

  dira[pin]~~
  outa[pin]~

  repeat reps * 2
    waitcnt(rate/2 + cnt)
    !outa[pin]

```

- 3) This solution uses global variables for days, hours, minutes, and seconds, and the GoodTimeCount method updates all four values. It would also be possible to just track seconds, and use other methods to convert to days, hours, etc.

```

''File: TickTock.spin

VAR

  long stack[50]
  byte cog
  long days, hours, minutes, seconds

PUB Start(setDay, setHour, setMinutes, setSeconds) : success
{{
Track time in another cog.

  Parameters - starting values for:
    setDay      - day
    setHour     - hour
    setMinutes  - minute
    setSeconds  - second
}}

  days := setDay
  hours := setHour
  minutes := setMinutes
  seconds := setSeconds

  Stop
  cog := cognew(GoodTimeCount, @stack)
  success := cog + 1

PUB Stop
''Stop counting time.

  if Cog
    cogstop(Cog~ - 1)

PUB Get(dayAddr, hourAddr, minAddr, secAddr) | time
{{
Get the current time. Values are loaded into variables at the
addresses provided to the method parameters.

  Parameters:
    dayAddr - day variable address
    hourAddr - hour variable address
    minAddr - minute variable address
    secAddr - second address
}}

```

Study Solutions

```
long[dayAddr] := days
long[hourAddr] := hours
long[minAddr] := minutes
long[secAddr] := seconds
```

```
PRI GoodTimeCount | dT, T
```

```
dT := clkfreq
T := cnt
```

```
repeat
```

```
  T += dT
  waitcnt(T)
  seconds ++
```

```
  if seconds == 60
    seconds~
    minutes++
```

```
  if minutes == 60
    minutes~
    hours++
```

```
  if hours == 24
    hours~
    days++
```

Counter Modules and Circuit Applications Lab Study Solutions

Counter Modules and Circuit Applications Lab Question Solutions

- 1) Each cog has two counter modules, A and B.
- 2) PHS, FRQ, and CTR.
- 3) PHSA, FRQA, and CTRA.
- 4) PHSB, FRQB, and CTRB.
- 5) The FRQ register.
- 6) The CTR (control) register.
- 7) In NCO mode, bit 31 of a given phs register is used to control one I/O pin in single ended mode, or two in differential mode. In PLL mode, the phase adder's carry flag (a.k.a PHS bit 32) controls the state of I/O pins
- 8) If a sensor's resistance or capacitance varies with an environmental variable, an RC decay measurement returns a time that's proportional to the sensor's value.
- 9) No, but it is with many other microcontrollers.
- 10) Yes, with NEG Detect mode, CTRMODE is %01100.
- 11) After the capacitor is fully charged, its voltage will take a certain amount of time to decay as its charge drains through the resistor. As a result, the voltage spends a certain amount of time above the I/O pin's 1.65 V logic threshold. For each clock tick that the voltage is above the I/O pin's logic threshold, it adds the value of FRQ to PHS. After the voltage has decayed below the threshold, FRQ no longer gets added to PHS, so PHS continues to store the number of ticks the signal was high.
- 12) In bits 30..26 of a given CTR register.
- 13) The mode of a given counter module's operation.
- 14) The CTRMODE and APIN fields.
- 15) The recommended value is 1, but so long as FRQ stores a non zero value that does not cause the PHS register to overflow during the measurement, it can be used to measure RC decay.
- 16) (1) Set the CTR register's mode bit field. (2) Set the CTR register's PIN bit field. (3) Set the PHS register to a non zero value, preferably 1.
- 17) The capacitor in the RC circuit has to be charged. Then, the PHS register's initial value needs to be noted, or it can be cleared. Immediately after that, the I/O pin should be set to input.
- 18) Because each counter independently accumulates its PHS register based on the value at a given I/O pin. So, two counters can be accumulating their respective PHS registers while their respective RC circuits are decaying but still above the I/O pin's logic threshold. In the meantime, the cog can be executing other commands.
- 19) With RC decay measurements, the counter module is monitoring the voltage applied to an I/O pin. In D/A conversion, the counter module is controlling an I/O pin.
- 20) The ratio of FRQ to 2^{32} determines the duty.
- 21) The phase adder's carry bit, which you can think of as bit 32 of the PHS register.
- 22) It makes it possible for the code to select from 256 different levels instead of 2^{32} different levels.
- 23) `spr[8]` through `spr[13]`.
- 24) `spr[9]`.
- 25) `spr[10]`.
- 26) The value in the `phsb` register.
- 27) (1) `ctrb := myVar`, and (2) `spr[9] := myVar`
- 28) `spr[8]` is `ctra`, and `SPR[9]` is `ctrb`. Each of these registers has several bit fields that affect the counter's behavior. The left shift `<<` operator can be used to shift a group of bits left to the

Study Solutions

correct position within one of these variables. A series of left shift operations can be combined with additions to determine each of a given CTR register's bit fields.

- 29) Bit 31 of the PHS register
- 30) The condition according to CTR.spin is Always, meaning that the FRQ register gets added to the PHS register with every clock cycle.
- 31) $2^{32}/\text{clkfreq}$
- 32) $\text{clkfreq}/2^{32}$
- 33) (1) Set the I/O pin to input, (2) clear the FRQ register, or (3) clear bits 31..26 in the CNT register.
- 34) Yes, Counter A can send one signal, Counter B can send the other.
- 35) Update the value stored in the FRQ register.
- 36) Yes, either POSEDGE or NEGEDGE detectors can sample the number of transitions over a certain amount of time to store frequency. Positive and Negative detectors can also be used to track the cycle's high and low time, which can in turn be used to calculate the frequency of a signal.
- 37) No, they compare the I/O pin's current logic state to the previous clock tick's logic state. If, for example, the I/O pin's previous logic state was 0 and the current state is 1, POSEDGE mode would add FRQ to PHS because a positive edge transition occurred.
- 38) No. Although `spr[13]` refers to `phsb`, it is not bit addressable. The repeat while command is referring to a bit in the `phsb` register. Although it would be possible to determine the value of that bit using various operations, it would take a lot more time than simply checking `phsb[31]`
- 39) 500 kHz to 128 MHz
- 40) The counter module's PLL circuits needs to receive an input frequency from bit 31 of the PHS register. The value stored in the FRQ register determines the frequency of the PHS register's bit 31, just like it did in NCO mode.
- 41) The counter module's PLL circuit multiplies it by 16, then a divider reduces the frequency by a power of two that falls in the 1 to 128 range.
- 42) (a) Calculate the PHS bit 31 frequency. (b) Use the PHS bit 31 frequency to calculate the VCO frequency. (c) Divide the VCO frequency by $2^{7-\text{PLLDIV}}$.
- 43) (1) Figure out the PLLDIV, which is the power of two that the VCO frequency will have to be divided by to get the frequency the I/O pin will transmit. Page 169 has a useful table for this calculation. (2) Multiply the PLL frequency by $2^{(7-\text{PLLDIV})}$ to calculate the VCO frequency. (3) Given the VCO frequency, calculate 1/16 of that value, which is the PHS bit 31 (NCO) frequency that the PLL circuit will need. (4) Since the value stored in FRQ determines NCO frequency, use the NCO frequency to calculate the FRQ register value

Counter Modules and Circuit Applications Lab Exercise Solutions

- 1) Solution:

```
...
' ctra[30..26] := %01000          ' Set mode to "POS detector"
ctr[30..26] := %01100          ' Set mode to "NEG detector"
...

' Charge RC circuit.
' Discharge RC circuit.

' dira[17] := outa[17] := 1      ' Set pin to output-high
dira[17] := 1                   ' Set pin to output-low
outa[17] := 0
...
```

- 2) Solution:
 'The duty for this signal is 1/3.3. Since duty = FRQ/2³², we can solve 1/3.3 = FRQ/2³² for FRQ. FRQ = 1_301_505_241
 ctrb[32..26] := %00110 ' Counter B to duty mode
 ctrb[5..0] := 7
 frqb := 1_301_505_241 ' Set duty for 3.3 V
 dirb[7] := 1 ' Set P7 to output
- 3) Solution:
 'The duty for this signal is 1/3.3. Since duty = FRQ/2³², we can solve 1/3.3 = FRQ/2³² for FRQ. FRQ = 1_301_505_241
 spr[9] := (%00110<<26) + 7 ' Counter B to duty mode, transmit P7
 spr[11] := 1_301_505_241 ' Set duty for 3.3 V
 spr[6] |= |< 7 ' Set P7 to output
- 4) Using FRQ register = PHS bit 31 frequency × 2³² / (clkfreq = 80 MHz) rounded to the closest integer:
 C6# → 59475, D6# → 66787, F6# → 79457, G6# → 89185, A6# → 100111
- 5) The frqa register will have to contain PHS bit 31 frequency × 2³² / (clkfreq = 20 MHz) = 224_734 (rounded to the closest integer).
 ctra[30..26] := %00100 ' Counter B to duty mode, transmit P16
 ctra[5..0] := 16
 frqb := 224_734 ' 20 MHz C7
 dira[16]~~ ' 20 MHz C7
- 6) Solution:
- ```

...
'repeat index from 0 to 7
repeat index from 0 to 12
...

DAT
'MODIFIED.....
'80 MHz frqa values for square wave musical note
' approximations with the counter module configured to NCO:
'
' C6 C6# D6 D6# E6 F6 F6#
notes long 56_184, 59_475 63_066, 66787, 70_786, 74_995, 79457
' G6 G6# A6 A6# B6 C7
long 84_181, 89_185, 94_489, 100_111, 105_629, 112_528

```
- 7) Since the SquareWave object uses **clkfreq** to calculate its FRQ register values, the only change that needs to be made is **\_xinfreq = 2\_000\_000** instead of **\_xinfreq = 5\_000\_000**.
- 8) Append **scale = 16\_777\_216** with **\* 2**, and then adjust the **repeat** loop from 0 to 255 to 0 to 127.
- 9) Change **ctrb[30..26] := %01110** to **ctrb[30..26] := %01010**. To get full cycles, you can initialize the **outa[27]** high instead of low. This assumes a piezospeaker, which does not consume current when voltage is applied to it. Some speakers look like piezospeakers but have inductors built in, which draw a lot of current when DC voltage is applied.
- 10) Set **tC** to **clkfreq/50** (that's 20 ms). For the 1.5 ms pulses,  $1.5 \times 10^{-3} \times \text{clkfreq}$  is approximately equivalent to  $(1/667) \times \text{clkfreq}$ , or **clkfreq/667**. So, **tHa** should be **clkfreq/667**. Another way to do it would be to add a **CON** block with **us = clkfreq/1\_000\_000**. Then, **tHa** can be **1500 \* us**.

## Study Solutions

---

- 11) Add a CON block with `us = clkfreq/1_000_000`. Initialize `tC` to `20_000 * us`. Initialize `tHa` to `700 * us`. Add a local variable named `count` to the `TestPwm` method. Change `repeat` to `repeat tHa from (700 * us) to (2200 * us)`.

- 12) Solution:

```

{{
TestDualPWM(Exercise 12).spin
Demonstrates using two counter modules to send a dual PWM signal.
The cycle time is the same for both signals, but the high times are independent of
each other.
}}

CON

 _clkmode = xtal1 + pll16x ' System clock → 80 MHz
 _xinfreq = 5_000_000

PUB TestPwm | tc, tHa, tHb, t, us ' <- Add us

 us := clkfreq/1_000_000 ' <- Add

 ctra[30..26] := ctrb[30..26] := %00100 ' Counters A and B → NCO single-ended
 ctra[5..0] := 4 ' Set pins for counters to control
 ctrb[5..0] := 6
 frqa := frqb := 1 ' Add 1 to phs with each clock tick

 dira[4] := dira[6] := 1 ' Set I/O pins to output

 tC := 20_000 * us ' <- Change Set up cycle time
 tHa := 700 * us ' <- Change Set up high times
 tHb := 2200 * us ' <- Change

 t := cnt ' Mark current time.

 repeat tHa from (700 * us) to (2200 * us) ' <- Change Repeat PWM signal
 phsa := -tHa ' Define and start the A pulse
 phsb := -tHb ' Define and start the B pulse
 t += tC ' Calculate next cycle repeat
 waitcnt(t) ' Wait for next cycle
```

## Counter Modules and Circuit Applications Lab Projects Solutions

- 1) Solution: Commented and uncommented versions of `DAC 2 Channel.spin` are shown below. Note in the uncommented version that it really doesn't take a lot of code to accomplish the project's specification.

```

''DAC 2 Channel.spin
''2 channel DAC object. Each channel is configurable for both I/O pin and
''resolution (bits).

VAR
' Stores values that functions as an LSB scalars for the FRQ registers.
long lsb[2]

PUB Init(channel, ioPin, bits, level)
{{
Initializes a DAC.
• channel - 0 or 1
• ioPin - Choose DAC I/O pin
• bits - Resolution (8 bits, 10 bits, etc.)
}}
bits
```

```

• level - Initial voltage level = 3.3 V * level ÷ 2
}}
dira[ioPin]~
spr[8 + channel] := (%00110 << 26) + ioPin
lsb[channel] := |< (32 - bits)
Update(channel, level)
dira[ioPin] ~~

PUB Update(channel, level)
.. Updates the level transmitted by an ADC channel to
.. bits
.. level = 3.3 V * level ÷ 2
spr[10 + channel] := level * lsb[channel]

PUB Remove(channel)
.. Reclaims the counter module and sets the associated I/O pin to input.
dira[spr[8+channel] & %111111]~
spr[8+channel]~

```

```

'' DAC 2 Channel.spin (uncommented version)

```

```

VAR
 long lsb[2]

PUB Init(channel, ioPin, bits, level)

 dira[ioPin]~
 spr[8 + channel] := (%00110 << 26) + ioPin

 lsb[channel] := |< (32 - bits)
 Update(channel, level)
 dira[ioPin] ~~

PUB Update(channel, level)

 spr[10 + channel] := level * lsb[channel]

PUB Remove(channel)

 dira[spr[8+channel] & %111111]~
 spr[8+channel]~

```

- 2) Solution: Added lines are highlighted below. Let's assume the servos are connected to P5 and P7. In the **repeat** loop, the **ctrA** and **ctrB** PIN fields will have to be set to 4 and 6 for the first pair of pulses, then changed to 5 and 7 for the second set of pulses. Also, a **waitcnt** has to be added after each pair of pulses so that the pulses have time to finish before moving on to the next pair of pulses.

At this point, the code still has about 15.6 ms left in the **repeat** loop, why not add a few more servos and make it a servo control object? See [forums.parallax.com](http://forums.parallax.com) → Propeller Chip → Propeller Education Kit Labs → PE Kit Servo Control for an example.

```

{{
TestDualPWM (Project 2).spin
Demonstrates using two counter modules to send a dual PWM signal.
The cycle time is the same for both signals, but the high times are independent of

```

## Study Solutions

```
each other.

Modified to control four servos.

}}

CON

 _clkmode = xtal1 + pll16x ' System clock → 80 MHz
 _xinfreq = 5_000_000

PUB TestPwm | tc, tHa, tHb, t, us ' <- Add us

 us := clkfreq/1_000_000 ' <- Add

 ctra[30..26] := ctrb[30..26] := %00100 ' Counters A and B → NCO single-ended
 ctra[5..0] := 4 ' Set pins for counters to control
 ctrb[5..0] := 6 '
 frqa := frqb := 1 ' Add 1 to phs with each clock tick

 dira[4] := dira[6] := 1 ' Set I/O pins to output
 dira[5] := dira[7] := 1

 tC := 20_000 * us ' <- Change Set up cycle time
 tHa := 700 * us ' <- Change Set up high times
 tHb := 2200 * us ' <- Change

 t := cnt ' Mark current time.

 repeat tHa from (700 * us) to (2200 * us) ' <- Change Repeat PWM signal

 ' First pair of pulses
 ctra[5..0] := 4 ' Set pins for counters to control
 ctrb[5..0] := 6 '
 phsa := -tHa ' Define and start the A pulse
 phsb := -tHb ' Define and start the B pulse
 waitcnt(2200 * us + cnt) ' Wait for pulses to finish

 ' Second pair of pulses
 ctra[5..0] := 5 ' Set pins for counters to control
 ctrb[5..0] := 7 '
 phsa := -tHa ' Define and start the A pulse
 phsb := -tHb ' Define and start the B pulse
 waitcnt(2200 * us + cnt) ' Wait for pulses to finish

 ' Wait for 20 ms cycle to complete before repeating loop
 t += tC ' Calculate next cycle repeat
 waitcnt(t) ' Wait for next cycle
```

- 3) DAC Object Solution: (It works, but keep in mind that it's not the only possible solution.)

```
{ {
 ' DualDac.spin

 ' Provides the two counter module channels from another cog for D/A conversion

 How to Use this Object in Your Application

 1) Declare variables the D/A channel(s). Example:

 VAR
 ch[2]

 2) Declare the DualDac object. Example:
```

```

OBJ
 dac : DualDac

3) Call the start method. Example:

 PUB MethodInMyApp
 ...
 dac.start

4) Set D/A outputs. Example:
 ch[0] := 3000
 ch[1] := 180

5) Configure the DAC Channel(s). Example:
 'Channel 0, pin 4, 12-bit DAC, ch[0] stores the DAC value.
 dac.Config(0,4,12,@ch[0])
 'Since ch[0] was set to 3000 in Step 4, the DAC's P4 output will be
 ' 3.3V * (3000/4096)

 'Channel 1, pin 6, 8-bit DAC, ch[1] stores the DAC value.
 dac.Config(1,6,8,@ch[1])
 'Since ch[1] was set to 180 in Step 4, the DAC's P6 output will be
 ' 3.3V * (180/256)

6) Methods and features in this object also make it possible to:
 - remove a DAC channel
 - change a DAC channel's:
 o I/O pin
 o Resolution
 o Control variable address
 o Value stored by the control variable

See Also

TestDualDac.spin for an application example.

}}

VAR
 long cog, stack[20]
 long cmd, ch, pin[2], dacAddr[2], bits[2]
 ' Global variables
 ' For object
 ' For cog info exchanges

PUB Start : okay

 '' Launches a new D/A cog. Use Config method to set up a dac on a given pin.
 okay := cog := cognew(DacLoop, @stack) + 1

PUB Stop

 '' Stops the DAC process and frees a cog.

 if cog
 cogstop(cog~ - 1)

PUB Config(channel, dacPin, resolution, dacAddress)

 '' Configure a DAC. Blocks program execution until other cog completes command.
 '' channel - 0 = channel 0, 1 = channel 1
 '' dacPin - I/O pin number that performs the D/A
 '' resolution - bits of D/A conversion (8 = 8 bits, 12 = 12 bits, etc.)
 '' dacAddress - address of the variable that holds the D/A conversion level,
 '' a value between 0 and (2^resolution) - 1.

```

## Study Solutions

---

```
ch := channel ' Copy parameters to global variables.
pin[channel] := dacPin
bits[channel] := |(32-resolution)
dacAddr[channel] := dacAddress
cmd := 4 ' Set command for PRI DacLoop.
repeat while cmd ' Block execution until cmd completed.

PUB Remove(channel)

'' Remove a channel. Sets channels I/O pin to input & clears the counter module.
'' Blocks program execution until other cog completes command.

ch := channel ' Copy parameter to global variable.
cmd := 5 ' Set command for PRI DacLoop.
repeat while cmd ' Block execution until cmd completed.

PUB Update(channel, attribute, value)

'' Update a DAC channel configuration.
'' Blocks program execution until other cog completes command.
'' channel - 0 = channel 0, 1 = channel 1
'' attribute - the DAC attribute to update
'' 0 -> dacPin
'' 1 -> resolution
'' 2 -> dacAddr
'' 3 -> dacValue
'' value - the value of the attribute to be updated

ch := channel ' Copy parameter to global variable.
case attribute ' attribute param decides what to do.
0 : ' 0 = change DAC pin.
cmd := attribute + (value << 16) ' I/O pin in upper 16 bits, lower 16
' cmd = 0.
' Options 1 through 3 do not require a command for PRI DacLoop -> PRI
' DacConfig.
' They just require that certain global variables be updated.
1 : bits[ch] := |(32-value) ' 1 = Change resolution.
2 : dacAddr[channel] := value ' 2 = Change control variable address.
3 : long[dacAddr] := value ' 3 = Change control variable value.
repeat while cmd ' Block execution until cmd completed.

PRI DacLoop | i ' Loop checks for cmd, then updates
' DAC output values.
repeat ' Main loop for launched cog.
if cmd ' If cmd <> 0
DacConfig ' then call DacConfig
repeat i from 0 to 1 ' Update counter module FRQA & FRQB.
spr[10+ch] := long[dacAddr][ch] * bits[ch]

PRI DacConfig | temp ' Update DAC configuration based on
' cmd.

temp := cmd >> 16 ' If update attribute = 0, temp gets
' pin.
case cmd & $FF ' Mask cmd and evaluate case by case.
4 : ' 4 -> Configure DAC.
spr[8+ch] := (%00110 << 26) + pin[ch] ' Store mode and pin in CTR register.
dira[pin[ch]]~ ' Pin direction -> output.
5 : ' 5 -> Remove DAC.
spr[8+ch]~ ' Clear CTR register.
dira[pin[ch]]~ ' Make I/O pin input.
0 : ' 0 -> update pin.
dira[pin[ch]]~ ' Make old pin input.
```



```

pin[ch] := temp ' Get new pin from temp local
 ' variable.
spr[8+ch] := (%00110 << 26) + pin[ch] ' Update CTR with new pin.
dira[pin[ch]]~~ ' Update new I/O pin direction ->
 ' output.
cmd := 0 ' Clear cmd to stop blocking in
 ' other cog.

```

### Solution - Menu driven test object for DualDac.spin

```

''TestDualDAC.spin
''Menu driver user tests for DualDac.spin

CON

 _clkmode = xtal1 + pll16x ' System clock → 80 MHz
 _xinfreq = 5_000_000

 ' Parallax Serial Terminal constants
 CLS = 16, CR = 13, CLREOL = 11, CRSRXY = 2, BKSPC = 8, CLRDN = 12

OBJ

 debug : "FullDuplexSerialPlus"
 dac : "DualDAC"

PUB TestPwm | channel, dacPin, resolution, ch[2], menu, choice

 debug.start(31, 30, 0, 57600)
 waitcnt(clkfreq * 2 + cnt)
 debug.str(@_Menu)

 dac.start

 repeat

 debug.tx(">")
 case menu := debug.rx
 "C", "c":
 debug.str(@_Channel)
 channel := debug.getdec
 debug.str(@_Pin)
 dacPin := debug.getdec
 debug.str(@_Resolution)
 resolution := debug.getdec
 dac.Config(channel, dacPin, resolution, @ch[channel])
 "S", "s":
 debug.str(@_Channel)
 channel := debug.getdec
 debug.str(@_Value)
 ch[channel] := debug.getdec
 "U", "u":
 debug.str(@_Update)
 case choice := debug.rx
 "P", "p":
 debug.str(@_Channel)
 channel := debug.getdec
 debug.str(@_Pin)
 dacPin := debug.getdec
 dac.update(channel, 0, dacPin)
 "B", "b":
 debug.str(@_Channel)
 channel := debug.getdec

```

## Study Solutions

---



```
 debug.str(@_Resolution)
 resolution := debug.getdec
 dac.update(channel, 1, resolution)
 "R", "r":
 debug.str(@_Channel)
 channel := debug.getdec
 dac.Remove(channel)
 debug.str(String(CRSRXY, 1,4, BKSPC, CLRDN))

DAT
_Menu byte CLS, "C = Configure DAC", CR, "S = Set DAC Output", CR
 byte "U = Update DAC Config", CR, "R = Remove DAC", CR, 0
_Channel byte CR, "Channel (0/1) > ", 0
_Pin byte "Pin > ", 0
_Resolution byte "Resolution (bits) > ", 0
_Value byte "Value > ", 0
_Update byte "Update Choices:", CR, "P = DAC Pin", CR, "B = Bits (resolution)"
 byte CR, 0
```

## Appendix C: PE Kit Components Listing

Parts, quantities, and component styles are subject to change without notice.

| Table C-1: Propeller Education Kit - 40-Pin DIP Version (#32305) |     |                                                                                 |
|------------------------------------------------------------------|-----|---------------------------------------------------------------------------------|
| Stock #                                                          | Qty | Description                                                                     |
| 130-32305                                                        | 1   | Propeller DIP Plus Kit, see Table 3-3 on page 25                                |
| 130-32000                                                        | 1   | Propeller Project Parts Kit, see Table C-2 below                                |
| 700-00077                                                        | 1   | Breadboard Set, see Table 3-1 on page 24                                        |
| 32201                                                            | 1   | Propeller Plug with retractable USB A to Mini-B Cable, see Table 3-2 on page 24 |
| 110-32305                                                        | 1   | Plastic Storage Box                                                             |

| Table C-2: PE Project Parts Kit (#130-32000) |     |                                                                                                                                      |
|----------------------------------------------|-----|--------------------------------------------------------------------------------------------------------------------------------------|
| Stock #                                      | Qty | Description                                                                                                                          |
| 150-01011                                    | 20  | 100 $\Omega$ Resistor, 1/4 watt (brown-black-brown)                                                                                  |
| 150-01020                                    | 4   | 1 k $\Omega$ Resistor, 1/4 watt (brown-black-red)                                                                                    |
| 150-01030                                    | 8   | 10 k $\Omega$ Resistor, 1/4 watt (brown-black-orange)                                                                                |
| 150-01040                                    | 3   | 100 k $\Omega$ Resistor, 1/4 watt (brown-black-yellow)                                                                               |
| 150-02020                                    | 4   | 2 k $\Omega$ Resistor, 1/4 watt (red-black-red)                                                                                      |
| 150-02210                                    | 8   | 220 $\Omega$ Resistor, 1/4 watt (red-red-brown)                                                                                      |
| 150-04710                                    | 4   | 470 $\Omega$ Resistor, 1/4 watt (yellow-violet-brown)                                                                                |
| 150-04720                                    | 1   | 4.7 k $\Omega$ Resistor, 1/4 watt (yellow-violet-red)                                                                                |
| 152-01031                                    | 2   | 10 k $\Omega$ Potentiometer                       |
| 200-01010                                    | 4   | 100 pF Capacitor, mono radial (101)              |
| 200-01031                                    | 4   | 0.01 $\mu$ F 50 V Capacitor, poly (103)          |
| 200-01040                                    | 4   | 0.1 $\mu$ F Capacitor, mono radial (104)         |
| 200-01050                                    | 1   | 1 $\mu$ F Capacitor, electrolytic (1 $\mu$ F)    |
| 200-01062                                    | 2   | 10 $\mu$ F Capacitor, electrolytic (10 $\mu$ F)  |
| 350-00001                                    | 2   | Green LED                                         |
| 350-00003                                    | 2   | Infrared LED                                      |
| 350-00006                                    | 2   | Red LED                                           |

# Components Listings

| Table C-2: PE Project Parts Kit (#130-32000) |     |                                                                                                                 |
|----------------------------------------------|-----|-----------------------------------------------------------------------------------------------------------------|
| Stock #                                      | Qty | Description                                                                                                     |
| 350-00007                                    | 2   | Yellow LED                     |
| 350-00009                                    | 2   | Photoresistor                 |
| 350-00014                                    | 2   | Infrared Receiver              |
| 350-00018                                    | 2   | Infrared Phototransistor      |
| 350-90000                                    | 2   | LED Standoff                   |
| 350-90001                                    | 2   | LED Light Shield               |
| 400-00002                                    | 4   | Tact Switch                    |
| 451-00303                                    | 2   | 3-pin male/male header         |
| 602-00015                                    | 1   | Dual Op-Amp IC, 8-pin DIP     |
| 800-00016                                    | 4   | 3" Jumper Wires, bag of 10  |
| 900-00001                                    | 2   | Piezospeaker                 |

# Appendix D: Propeller Microcontroller Block Diagram

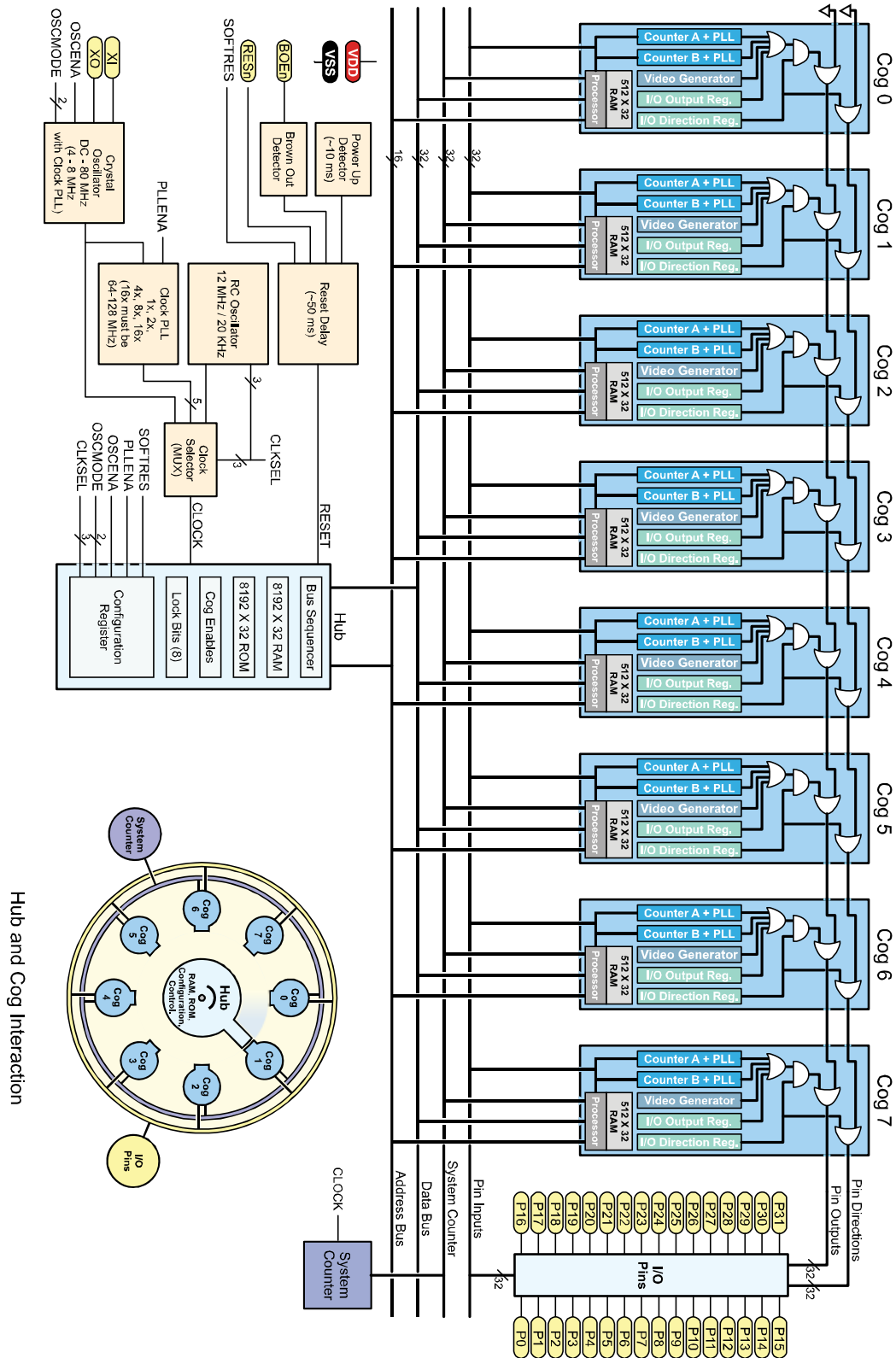

### Appendix E: LM2940CT–5.0 Current Limit Calculations

Although the LM2940CT-5.0 voltage regulator has a commercial temperature of 0 °C to 125 °C, the PE Platform’s 5 V regulator design is intended for use at room temperature. Supply voltages can be reduced to increase either the current budget or operating temperature, and you can use the equations in the Load Current vs. Ambient Temperature section to determine maximum output current at a given temperature.

Keep in mind that the PE Kit’s breadboards are also designed for use at room temperature, and that the plastic will likely deform if exposed to high temperatures.

#### Load Current vs. Ambient Temperature

According to the National Semiconductor’s LM2940 datasheet (available from national.com), the maximum allowable junction to ambient thermal resistance ( $\theta_{JA}$ ) for the TO220 packaged used in the PE Kit is 53 °C/W. This quantity can be described in terms of the maximum allowable temperature rise ( $T_{R(MAX)}$ ) and the power dissipated ( $P_D$ ) as:

$$\theta_{JA} = \frac{T_{R(MAX)}}{P_D} \geq 53 \text{ } ^\circ\text{C/W}$$

...where  $T_{R(MAX)}$  is the difference between the maximum junction temperature ( $T_{J(MAX)}$ ) and the maximum ambient temperature  $T_{A(MAX)}$ . The maximum junction temperature is 125 °C for the LM2940CT-5.0

$$T_{R(MAX)} = T_{J(MAX)} - T_{A(MAX)} = 125 \text{ } ^\circ\text{C} - T_{A(MAX)}$$

$P_D$  is also related to the input voltage ( $V_{IN}$ ), output voltage ( $V_{OUT}$ ), load current ( $I_L$ ), and quiescent current ( $I_G$ ) by:

$$P_D = (V_{IN} - V_{OUT})I_L + (V_{IN})I_G$$

For the PE Kit,  $V_{IN} = 9 \text{ V}$ ,  $V_{OUT} = 5 \text{ V}$ , and from the datasheet,  $I_G$  will not exceed 20 mA.

Solving for load current in terms of the other variables and constants, we have:

$$I_L \leq \frac{\frac{T_{J(MAX)} - T_{A(MAX)}}{\theta_{JA}} - (V_{IN})I_G}{V_{IN} - V_{OUT}}$$

Substituting constants supplied by the datasheet, load current as a function of maximum ambient temperature for a fixed 9 V input voltage.

$$I_L \leq \frac{\frac{125 \text{ } ^\circ\text{C} - T_{A(MAX)}}{53 \text{ } ^\circ\text{C/W}} - (9\text{ V})(20 \text{ mA})}{9\text{ V} - 5\text{ V}}$$

$$I_L \leq 0.545 - (4.72 \times 10^{-3})T_{A(MAX)}$$

For a maximum ambient temperature of 80 °F  $\approx$  26.7 °C, the maximum load current  $I_L = 419$  mA.

### Output capacitor ESR

The LM2940 datasheet has stability requirements for the output capacitor's capacitance (minimum 22  $\mu$ F) and ESR (equivalent series resistance). For the PE Kit's 0 to 400 mA range, the output capacitor's ESR has to stay in the 0.1  $\Omega$  to 1.0  $\Omega$  range to prevent output voltage oscillations.

At this time, the output capacitor for the PE Kit is a Nichicon VR series 25 V, 1000  $\mu$ F capacitor. The catalog specifications for this capacitor state that the dissipation loss ( $\tan \delta$ ) is 0.16 at 120 Hz for a 25 V, 1000  $\mu$ F capacitor. *According to Nichicon's General Description of Aluminum Electrolytic Capacitors*, the dissipation loss is the reciprocal of the impedance, which can be used to determine ESR (TECHNICAL NOTES CAT.8101E, page 6).

$$\tan \delta = \frac{1}{X_C} = 2\pi fC(ESR)$$

$$ESR = \frac{\tan \delta}{2\pi fC} = \frac{0.16}{2\pi 120(1000\mu)} = 0.212\Omega$$

The Nichicon VR series specifications also state that the maximum impedance ratio of Z-25°C/Z+20°C) is 2. This impedance ratio along with the room temperature ESR calculation indicate that the ESR will not exceed 0.424  $\Omega$  at -25 °C. So, although the LM2940 datasheet states that electrolytic capacitor ESR values can increase drastically at low temperatures, the 1000  $\mu$ F capacitor in the PE Kit do not pose a stability risk down to -25° C, which is well below the LM2940CT-5.0 regulator's temperature rating.

## Index

- #
- # Object-Constant reference, 107
- %
- % Binary number indicator, 54
- 
- `_clkmode`, 51
- `_stack`, 74
- `_xinfreq`, 51
- 2
- 24LC256 EEPROM, 27
- 3
- 3.3 V Regulator, 21
- 32 KB EEPROM, 22
- 32-bit signed number range, 60
- 5
- 5.0 V Regulator, 21
- 5.00 MHz crystal oscillator, 22
- 9
- 9 V Battery-to-Breadboard Connector, 21
- A
- Address
  - Passing starting addresses, 114
    - symbol `@`, 109
- APIN bit field, 125
- Array, 60
- Assembly language, 44, 109
- Assignment operators, 58
- Audio, 137
- B
- Bandpass filter, 173
- Bandreject filter, 173
- Battery clip, 30
- Baud rates, 99
- Binary number indicator `%`, 54
- Binary operators, 58
- Bitwise NOT `!`, 54
- Bitwise operators, 58
- Block Comments**, 45
- Boolean operators, 58
- BPIN bit field, 125
- Breadboard
  - coordinates, 26
  - Kit contents, **24**
- byte**, 60, 110
- C
- Calling a method (diagram), 69
- Character Chart tool, 92
- Child objects, 11
- Circuits
  - Drawing with Propeller Tool, 92
  - inductor-capacitor (LC), 171
  - Infrared emitter and receiver, 148, 150
  - LEDs, 130
  - metal detector, 172
  - parallel resistor, 172
  - PE Platform, 27
  - Piezospeakers, 137
  - Pushbutton and LEDs, 68
  - Pushbuttons, 44
  - RC Decay, 122
  - self-monitoring pulse train, 160
- CLK register, 51
- `clkfreq`, 49, 52
- `cnt`, 49
- `cnt` register, 49
- Code indenting, 50
- `cognit`, 72
- `cognew`, 71
- Cogs, 7
  - cog ID indexing, 76
  - cog RAM, 9
  - definition, 44
  - direction registers, 46, 63
  - input registers, 48
  - launching (diagram), 10
  - launching with `cognew`, 71
  - numbering, 10
  - output registers, 46, 63
  - stopping, 72
- `cogstop`, 72
- COM ports - troubleshooting, 37
- Comments
  - block, 45
  - documentation comments `"and {{{}}`, 90
- Comparison operators, 58
- CON**, 51, 74
- Conditional execution blocks (**if**), 58
- Copyright
  - MIT License for Object Exchange, 193
  - terms of use of this text, 2
- Counter modules, 121
- Counters
  - and D/A conversion, 129
  - and PWM with NCO modes, 156



CTRA/B Register Map, 124  
 CTRMODE bit field, 124  
 Differential DUTY mode, 133  
 differential PLL mode, 166  
 DUTY modes, 129  
 Infrared detection, 147  
 metal detection with PLL and POS detector modes,  
   171  
 NCO mode and IR detection, 150  
 NCO modes, 137  
 NEGEDGE detector mode, 170  
 NEGEDGE modes, 153  
 PLL internal mode for video, 166  
 PLL modes, 166  
 POS detector modes, 123  
 POSEDGE modes, 153  
 single-ended DUTY mode, 129  
 single-ended PLL mode, 166  
 Square wave generation, 140  
 Using both A and B, 133  
 Using two to play notes, 145  
 Crystal oscillator, 52  
 Crystal Oscillator, 22  
 CTR register, 122  
**ctra**, 124  
**ctrb**, 124  
 CTRMODE bit field, 124  
 Current  
   current limit calculations for 5 V regulator, 222  
   maximum for PE Platform, 21

## D

**DAT**, 108, 110  
 Differential DUTY mode, 133  
 Differential PLL mode, 166  
 Differential signals, 133  
 Digital-to-analog conversion, 129  
**dira** register, 46  
 Documentation view, 45  
 Documentation View, 91  
 Dot notation, 83  
 Drawing schematics, 92  
 DUTY  
   differential, 133  
 DUTY mode  
   single-ended, 129  
 DUTY modes, 129

## E

Eddy currents, 176  
 Edge detection , with Counters, 155  
 EEPROM, 12  
   loading programs into, 36  
 Electrostatic discharge (ESD) precautions, 24  
**else**, 58  
**elseif**, 58  
**elseifnot**, 58  
 Errata, 2, 6

## F

Filters, 173  
 Floating-point format support, 110  
 Font, Parallax font, 92  
 Frequency  
   musical notes, 138  
   resonant frequency, 172  
   testing for resonant, 177  
   VCO and counters, 166  
**from**, 55  
 FRQ register, 122  
   and setting duty, 132  
 FTDI's VCP USB drivers, 17

## G

Global variables, 44, 62  
 GND, 26  
 Guarantee, 2

## H

Hub, 7, 9

## I

I/O pins  
   abbreviation for Input/Output, 34  
 I/O Pins  
   direction, 46  
   group operations, 47  
   reading inputs, 48  
   testing the wiring, 36  
   voltage states, 48  
**if**, 58  
**ina**, 48  
**ina** register, 48  
 Increment ++, 55  
 indentation, 50  
 Inductors, 171  
 Infrared emitter.receiver schematics, 148  
 Infrared object and distance detection, 147  
 Input register, 48  
 Is Equal ==, 55

## L

LC XE "Circuits:inductor-capacitor (LC)" (inductor-  
   capacitor) circuits, 171  
 LEDs schematic, 44  
 Less Than <, 55  
 Limit Maximum <#, 61  
 Limit Minimum #>, 61  
 LM2937ET-3.3, 21  
 LM2940CT-5.0, 21  
 Loading programs, 12, 36  
 Local variables, 61, 68  
   definition, 44  
   size, 62  
**long**, 60, 110

# Index

---

**lookup**, 135  
**lookupz**, 135

## M

Machine codes, 11

Memory

- access conflicts, 7
- Address symbol @, 109
- local variables, 61
- main memory, 7
- main RAM, 7
- variable sizes, 60

Metal detector schematics, 172

Method

- call, 67, 68
- calling in other cog, 83
- defining local variables in call, 69
- definition, 44
- dot notation, 83
- launching into cogs, 71
- method block, 45
- method calls in expressions, 75
- object-method reference, 83
- parameter list, 69
- parameter passing, 69
- Public vs Private, 93
- result** variable, 74
- return value alias for **result**, 76
- returning from, 69
- stack space, 73
- Start method, 88, 90
- Stop method, 88, 90

MIT License for Object Exchange, 193

Modulus //, 63

Music notes, 138

## N

NCO modes, 137

Negative numbers, 104

NEGEDGE detector mode, 170

NEGEDGE modes, 153

Normal operators, 58

**NOT**, 58

Numerically controlled oscillator (NCO), 137

## O

Object

- Child object, 11
- definition, 44
- Dot notation, 83
- launching process into cog, 86
- MIT License, 193
- multiple instances of, 94
- Object-Constant reference #, 107
- Object-method reference, 83
- organization, 84
- Parent object, 11
- Top object, 11
- Using global variables, 111

working with variable lists, 114

Object Info window, 72, 85

Object Listings

- 1Hz25PercentDutyCycle.spin, 157
  - 1Hz25PercentDutyCycleDiffSig.spin, 158
  - AddressBlinker.spin, 112
  - AddressBlinkerControl.spin, 113
  - AddressBlinkerWithOffsets.spin, 114
  - AnotherBlinker.spin, 68
  - BetterCountEdges.spin, 155
  - Blinker.spin, 87
  - BlinkWithParams.spin, 70
  - ButtonBlink.spin, 83
  - ButtonShiftSpeed.spin, 60
  - ButtonToLed.spin, 48
  - CalibrateMetalDetector.spin, 178
  - CallBlink.spin, 69
  - CogObjectExample.spin, 86
  - CogStartStopWithButton.spin, 77
  - ConstantBlinkRate.spin, 52
  - CountEdgeTest.spin, 154
  - DisplayPushbuttons.spin, 106
  - DoNothing.spin, 36
  - DoReMi.spin, 142
  - DualDac.spin, 183
  - EnterAndDisplayValues.spin, 104
  - FloatStringTest.spin, 111
  - FullDuplexSerialPlus.spin, 187
  - GroupIoSet.spin, 47
  - HelloFullDuplexSerial.spin, 98
  - IncrementOuta.spin, 55
  - IncrementUntilCondition.spin, 56
  - IrDetector.spin, 150
  - IrObjectDetection.spin, 149
  - LedDutySweep.spin, 133
  - LedOnOffP4.spin, 49
  - LedSweepWithSpr.spin, 136
  - MonitorPWM.spin, 162
  - MultiCogObjectExample.spin, 94
  - PushbuttonLedTest.spin, 34
  - ShiftRightP9toP4.spin, 59
  - SinglePulseWithCounter.spin, 156
  - SinglePWM with Time Increments.spin, 159
  - SquareWave.spin, 193
  - SquareWaveTest.spin, 140
  - Staccato.spin, 141
  - TerminalButtonLogger.spin, 118
  - TerminalFrequencies.spin, 144
  - TerminalLedControl.spin, 108
  - TestDualPwm.spin, 158
  - TestDualPWM.spin, 183
  - TestDualPwmWithProbes.spin, 160
  - TestIrDutyDistanceDetector.spin, 152
  - TestMessages.spin, 109
  - TestPIIParameters.spin, 170
  - TestRcDecay.spin, 127
  - TimeCounter.spin, 64
  - TwoTones.spin, 145
  - TwoTonesWithSquareWave, 146
- Object view, Propeller Tool, 85
- Object-Constant reference #, 107
- Object-method reference, 83

Operand, 58  
 Operators  
   Assignment, 58  
   Binary, 58  
   Bitwise, 58  
   Bitwise NOT **!**, 54  
   Boolean, 58  
   Boolean NOT, 58  
   Comparison, 58  
   Increment **++**, 55  
   Is Equal **==**, 55  
   Less Than **<**, 55  
   Limit Maximum **<#**, 61  
   Limit Minimum **#>**, 61  
   method calls in expressions, 75  
   Modulus **//**, 63  
   Normal, 58  
   Operand, 58  
   Post-Clear **~**, 53  
   Post-Set **~~**, 53  
   Pre- and Post-, 56  
   Shift Left **>>**, **>>=**, 58  
   shift operators, 58  
   Subtract **-**, 58  
   Symbol address **@**, 109  
   Unary, 58  
**outa** register, 46  
 Output register, 46

## P

Parallax font, 92  
 Parallax Serial Terminal, 17, 18  
   sending data to the Propeller chip, 103  
 Parallax Serial Terminal software, 95  
 Parameter  
   list, 69  
   parameter passing (diagram), 70  
   passing between methods, 69  
 Parent object, 11  
 Phase-locked loop  
   PLL divider and Counter modules, 125  
 Phase-locked loop (PLL), 51  
 PHS register, 122  
**phsa**, 125  
**phsb**, 134  
 Piezospeaker schematic, 137  
 Piezospeakers, 137  
 PLL internal mode, 166  
 PLL modes, 166  
 PLLDIV bit field, 125, 168  
 Polling, 154  
 POS detector mode, 123  
 POS detector modes, 123  
 POSEDGE modes, 153  
 Post-Clear **~**, 53  
 Post-Set **~~**, 53  
**PRI**, 93, 110  
 Program loops, 46, *See* repeat  
 Propeller chip, 20  
   block diagram, 221  
   built-in RC oscillator, 22

  internal RC clock precision, 52  
   main memory, 7  
   package types, 7  
   ROM, 8  
   Warranty, 2  
   wiring diagram, 30  
 Propeller DIP Plus Kit, **25**  
   schematic, 27  
 Propeller Education (PE) Kit, 12  
   components listing, 219  
 Propeller Object Exchange, 10  
 Propeller Plug, 17, 22, **24**  
 Propeller Tool  
   Character Chart tool, 92  
   Documentation View, 91  
   drawing schematics with, 92  
   Object Info window, 85, 102  
   Object View, 85  
   system requirements, 17  
 Propeller Tool software  
   Floating-point format support, 110  
 PropStick USB, 13  
**PUB**, 45, 93, 110  
 Pulse width modulation (PWM), 156  
 Pushbutton schematic, 44

## R

RAM  
   Cog RAM, 9  
   loading programs into, 36  
 RC Decay, 122  
 RC decay measurement, 126  
**RCFAST**, 52  
 Registers  
   and Counter modules, 122  
   bit patterns in, 54  
   CLK, 51  
   **cnt**, 49  
   CTR, 122  
   **ctra**, 124  
   CTRA/B Register Map, 124  
   **ctrb**, 124  
   **dira**, 46  
   FRQ, 122  
   **ina**, 48  
   input, 48  
   **outa**, 46  
   PHS, 122  
   special-purpose, 46  
   SPR, 134  
**repeat**, 46  
   conditional looping, 55  
 Reset button, 21  
 Resources for Beginners, 14  
**result**, 74  
 Return value alias for **result**, 76  
 ROM, 8

## S

Schematics, drawing with Propeller Tool, 92

# Index

---

Serial-over-USB connection, 22  
Servo and motor control, 156  
Shift operators, 58  
Single-ended DUTY mode, 129  
Single-ended NCO mode, 137  
Single-ended PLL mode, 166  
Speakers, 137  
Special purpose register, 134  
Special purpose registers, 46, 122  
  and counter modules, 122  
Spin language, 44  
  **\_clkmode**, 51  
  **\_stack**, 74  
  **\_xinfreq**, 51  
  **byte**, 60, 110  
  **clkfreq**, 49, 52  
  **cnt**, 49  
  **coginit**, 72  
  **cognew**, 71  
  **cogstop**, 72  
  **CON**, 51, 74  
  **ctra**, 124  
  **ctrb**, 124  
  **DAT**, 108, 110  
  **dira**, 46  
  **else**, 58  
  **elseif**, 58  
  **elseifnot**, 58  
  **from**, 55  
  **if**, 58  
  **ina**, 48  
  **long**, 60, 110  
  **lookup**, 135  
  **lookupz**, 135  
  **NOT**, 58  
  Operators. *See* Operators  
  **outa**, 46  
  **phsa**, 125  
  **phsb**, 134  
  **pllxx**, 52  
  **PRI**, 93, 110  
  **PUB**, 45, 93, 110  
  **rcfast**, 52  
  **repeat**, 46  
  **result**, 74  
  **spr**, 134  
  **step**, 55  
  **string**, 101  
  **to**, 55  
  until, 55  
  **VAR**, 60, 110  
  **waitcnt**, 49  
  **while**, 55  
  **word**, 60, 110  
  **xtal**, 52  
**spr**, 134  
SPR, 134  
Square wave generation, 140  
Stack space  
  calculating need, 73

  definition, 67  
  Start method, 88, 90  
  **step**, 55  
  Stop method, 88, 90  
  Stopping cogs, 72  
  **string**, 101  
  Subtract -, 58  
  Symbol address @, 109

## T

Technical support, 18  
Timekeeping applications, 62  
**to**, 55  
Tokens, 9  
Top object file, 11  
Troubleshooting Guide, 37  
Twos complement, 104

## U

Unary operators, 58  
until, repeat, 55

## V

**VAR**, 60, 110  
Variables  
  array, 60  
  declaring, 60, 112  
  declaring local vs global, 61  
  in different types of blocks, 110  
  objects using global variables, 112  
  sizes, 60  
  **VAR** block, 60  
  variable lists, 114  
VDD, 26  
Video signals, 166  
ViewPort, 8, 15  
Virtual COM Port, 23  
Voltage regulators  
  LM2937-3.3, 29  
  LM2940 5 V, 29  
  LM2940 CT current limit calculations, 222  
  PE Platform circuit, 27  
VSS, 26

## W

**waitcnt**, 49  
Warranty, 2  
**while, repeat**, 55  
White space in code, 50  
**word**, 60, 110

## X

**xtal**, 52