

ACT8870EVK1-102 User's Guide

Description

This document describes the characteristics and operation of the Active Semi ACT8870EVK1-102 evaluation kit (EVK). It provides setup and operation instructions, schematic, layout, BOM, and test data. This EVK demonstrates the ACT8870QJ102 ActivePMU power management IC. Other ACT8870QJxxx options can be evaluated on this EVK by replacing the IC and any other necessary components.

Features

The EVK can be used as a standalone board if desired. However, to access the internal registers and to take full advantage of the IC's capability, the user must connect the EVK kit to a PC with Active Semi's USB-TO-I2C interface dongle and use the GUI software. The EVK provides full access to the each converter's input and output voltage, as well as all the digital control signals. This gives the user the flexibility to configure the EVK to match their real world system.

Note that the ACT8870EVK1-102 is specifically configured for the ACT8870QJ102.

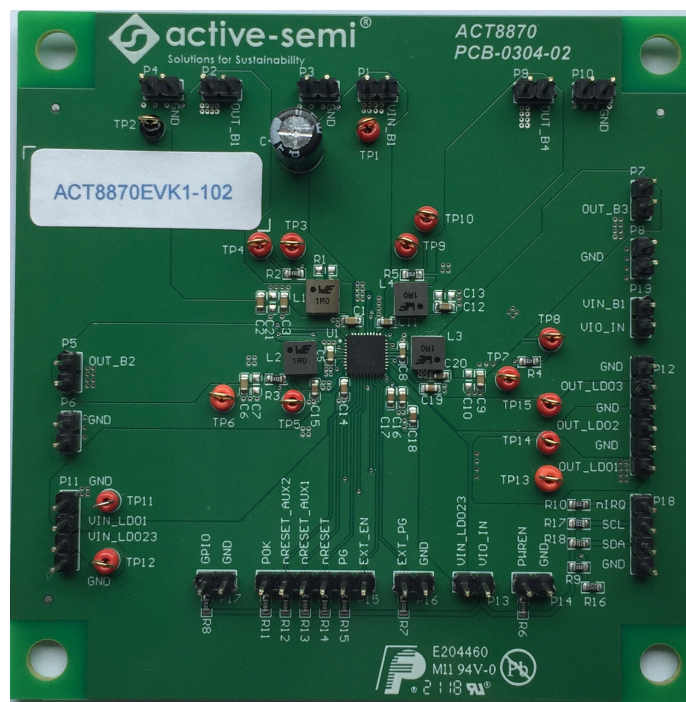

Figure 1 – EVK Picture

EVK Contents

The ACT8870EVK1-102 evaluation kit comes with the following items:

1. EVK assembly
2. USB-TO-I2C dongle
 - a. Dongle
 - b. Custom 4-pin connector that connects the USB-TO-I2C dongle to the EVK assembly

Required Equipment

ACT8870 EVK

USB-TO-I2C Dongle

Power supply – 5V @ 4A for full power operation

Oscilloscope – >100MHz, >2 channels

Loads – Electronic or resistive. 2.5A minimum current capability.

Digital Multimeters (DMM)

Windows compatible computer with spare USB port.

Hardware Setup

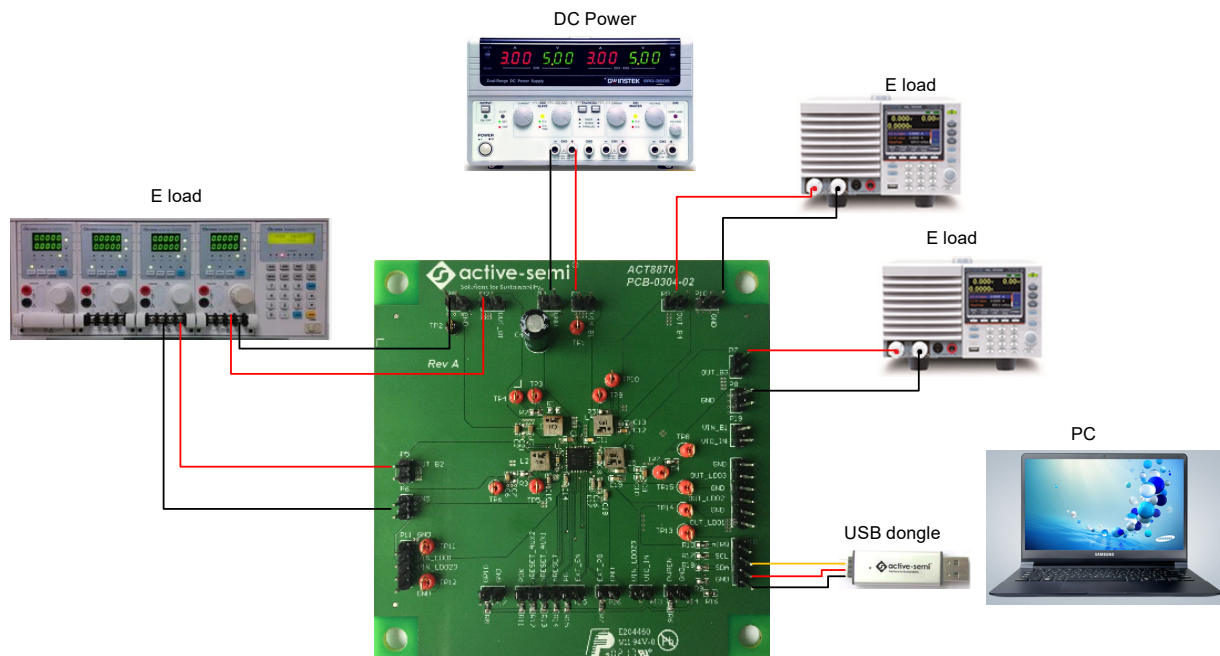
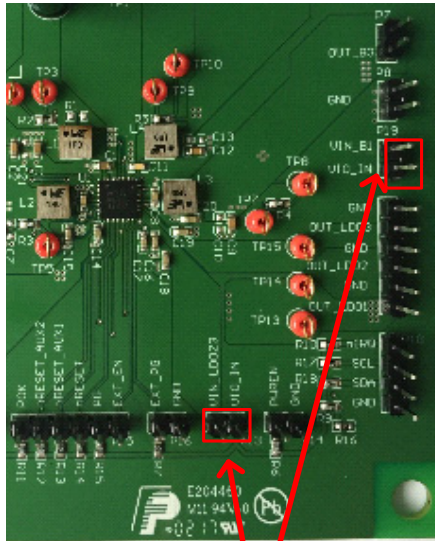

Figure 2 – EVK Setup

Quick Start

Hardware Setup

1. Decide which voltage will power VIO_IN. Active Semi recommends powering VIO_IN from the VIN_B1 input. Connect a shorting jumper across the P19 header to power VIO_IN from the VIN_B1 input voltage, OR connect a shorting jumper across the P13 header to power VIO_IN from the VIN_LDO23 input voltage.
2. **NOTE:** Do not connect a shorting jumper across both P13 and P19 if VIN_LDO23 and VIN_B1 are different voltages.



Apply shorting jumper in only **ONE** of these two locations

Figure 3 – VIO_IN Jumper Settings

3. Connect a lab supply between P1 and P3 to power VIN_B1.
4. Connect a lab supply between P11-1 and P11-2 to power VIN_LDO1.
5. Connect a lab supply between P11-4 and P11-3 to power VIN_LDO23.
6. Connect an appropriate load to each power supply output.
7. Note that the typical setup is to apply the same 5V input voltage to all inputs. Using different input voltage sources requires careful consideration of startup sequencing.
8. Turn on the lab supplies and the outputs turn on and sequence up automatically.

GUI Setup (optional)

1. Refer to the end of this document for detailed instructions to install the ACT8870 GUI.
2. Connect the USB-TO-I2C dongle to the computer via a USB cable.
3. Connect the USB-TO-I2C dongle to the EVK P18 connector. Refer to Figure 4 to ensure the correct polarity of the connection. As a guide, use the “Active-Semi” logo on the top of the dongle so the black wire is connected to the Dongle GND pin.

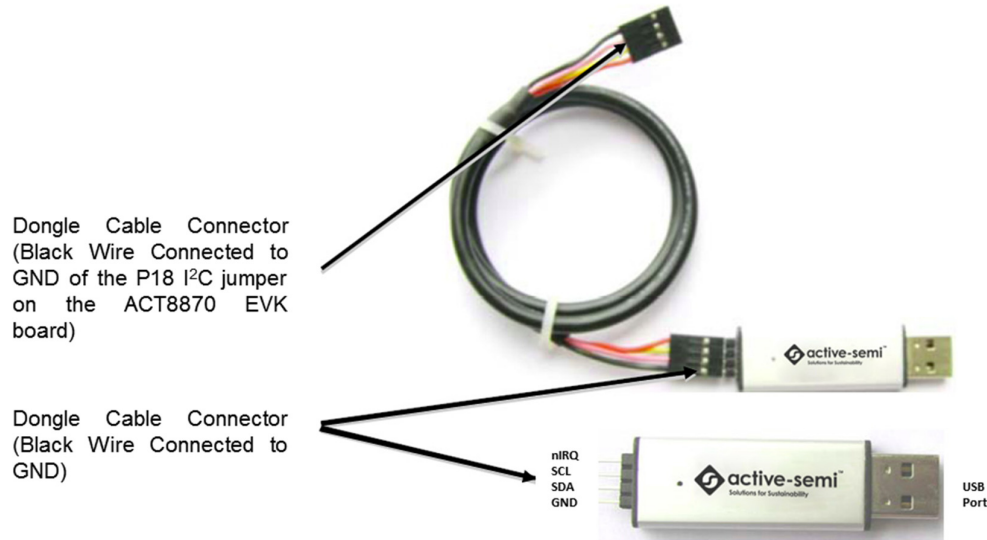

Figure 4 – USB-TO-I2C Dongle Connection

EVK Design Parameters

The ACT8870EVK1-102 is designed for a 5V input voltage. The maximum operating voltage is determined by the IC's maximum input voltage rating. The minimum operating voltages are determined by the buck converters' minimum input voltage and by the LDOs' dropout voltages. Maximum currents are determined by the IC's CMI settings, which can be changed via I2C after startup.

Table 1. EVK Design Parameters

Parameter	Description	Min	Typ	Max	Unit
VIN_B1	All buck input voltages	4.5	5	5.5	V
VIN_LDO1	LDO1 input voltage	4.5	5	5.5	V
VIN_LDO23	LDO23 input voltage	4.5	5	5.5	V
I _{B1_max}	Maximum Buck 1 load current		4.0		A
I _{B2_max}	Maximum Buck 2 load current		2.0		A
I _{B3_max}	Maximum Buck 3 load current		2.0		A
I _{LDO1_max}	Maximum LDO 1 load current		0.5		A
I _{LDO2_max}	Maximum LDO 2 load current		0.2		A
I _{LDO3_max}	Maximum LDO 3 load current		0.2		A

EVK Operation

Turn On

Apply the 5V input voltage. All outputs automatically turn on with the programmed startup sequence.

Pin Selectable (or VID) Outputs

Both Buck2 and Buck3 output voltages are pin selectable. This means that a GPIO input determines the output voltage. They are controlled with EXT_PG and nRESET_AUX2 respectively. If these pins default to a logic H if they are not actively pulled to ground. Pulling these pins high or low sets the voltages below.

EXT_PG (P16) = H sets BUCK2 = 1.35V

EXT_PG (P16) = L sets BUCK2 = 1.5V

nRESET_AUX2 (P15) = H sets BUCK3 = 1.8V

nRESET_AUX2 (P15) = L sets BUCK3 = 1.2V

Sleep Mode

Enter Sleep Mode by pulling PWREN low. In Sleep Mode, the BUCK4 output voltage is 0.95V and BUCK1/2/3 outputs turn off.

Test Results

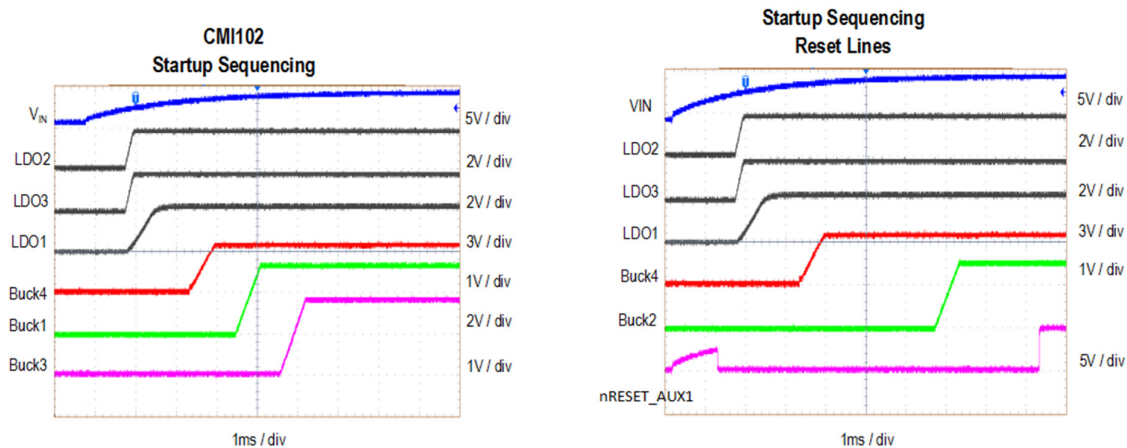

Sleep Mode Enter

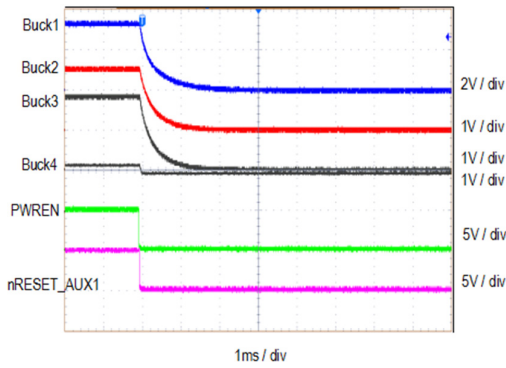

Sleep Mode Exit

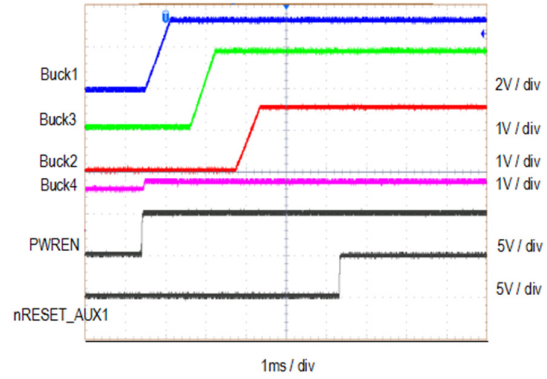

DVS transition
Buck2 1.35V to 1.5V
Buck3 1.2V to 1.8V

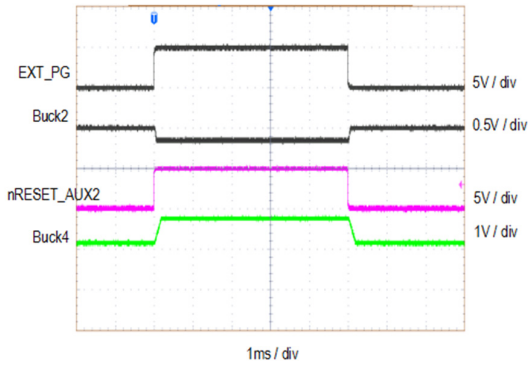

Buck1 Ripple & SW @4A

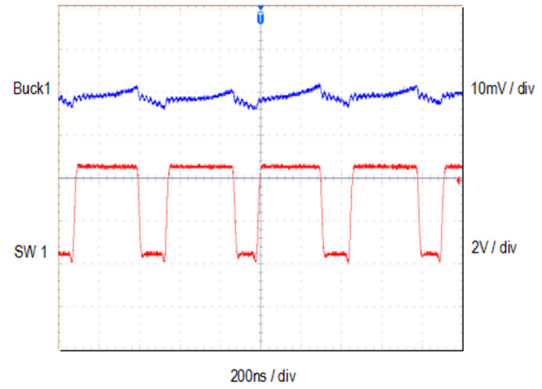

Buck2 Ripple & SW @2A
EXT_PG Low

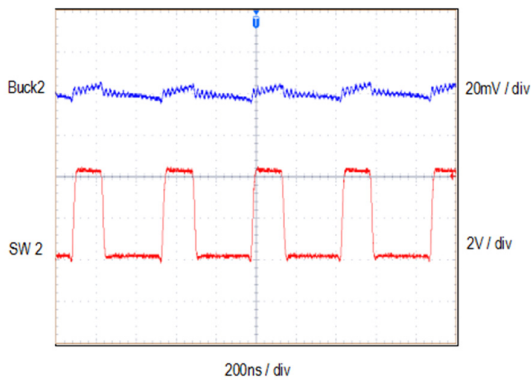

Buck3 Ripple & SW @1.5A
nRESET_AUX2 High

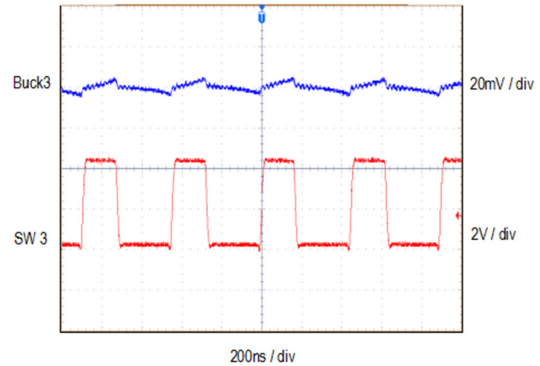

Buck4 Ripple & SW @2.5A

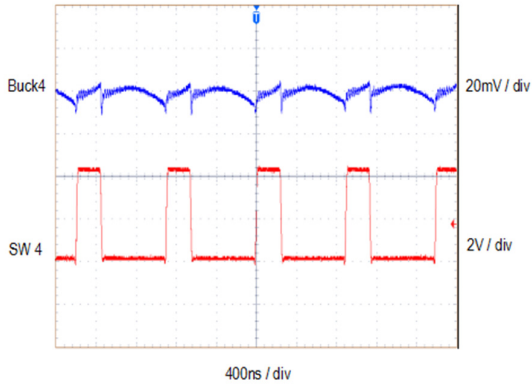

Load Transient
Buck1- Vout=3.3V
1A to 3A

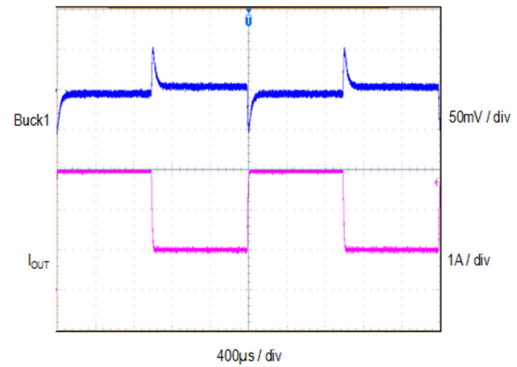

Load Transient
Buck2- Vout=1.5V
0.5A to 1.5A

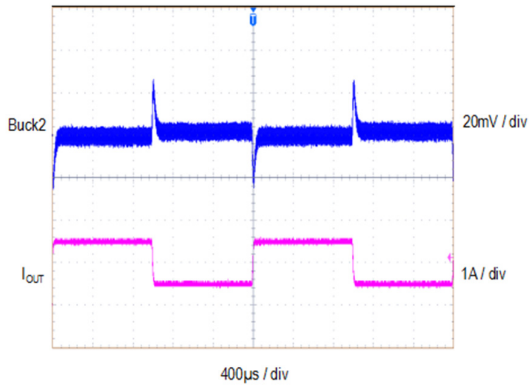

Load Transient
Buck3- Vout=1.8V
0.375A to 1.125A

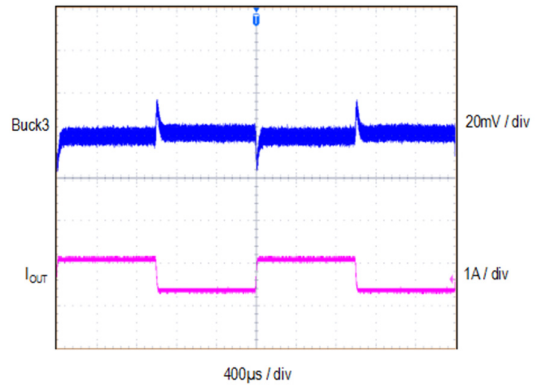

Load Transient
Buck4- Vout=1.15V
0.625A to 1.875A

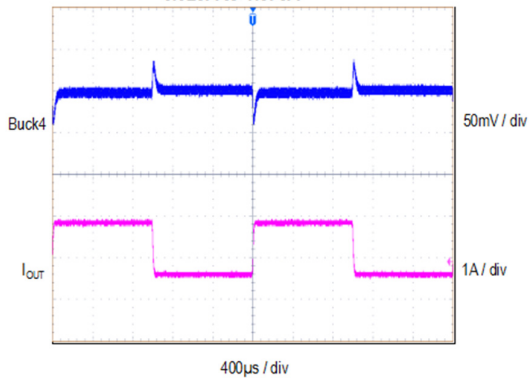

Schematic

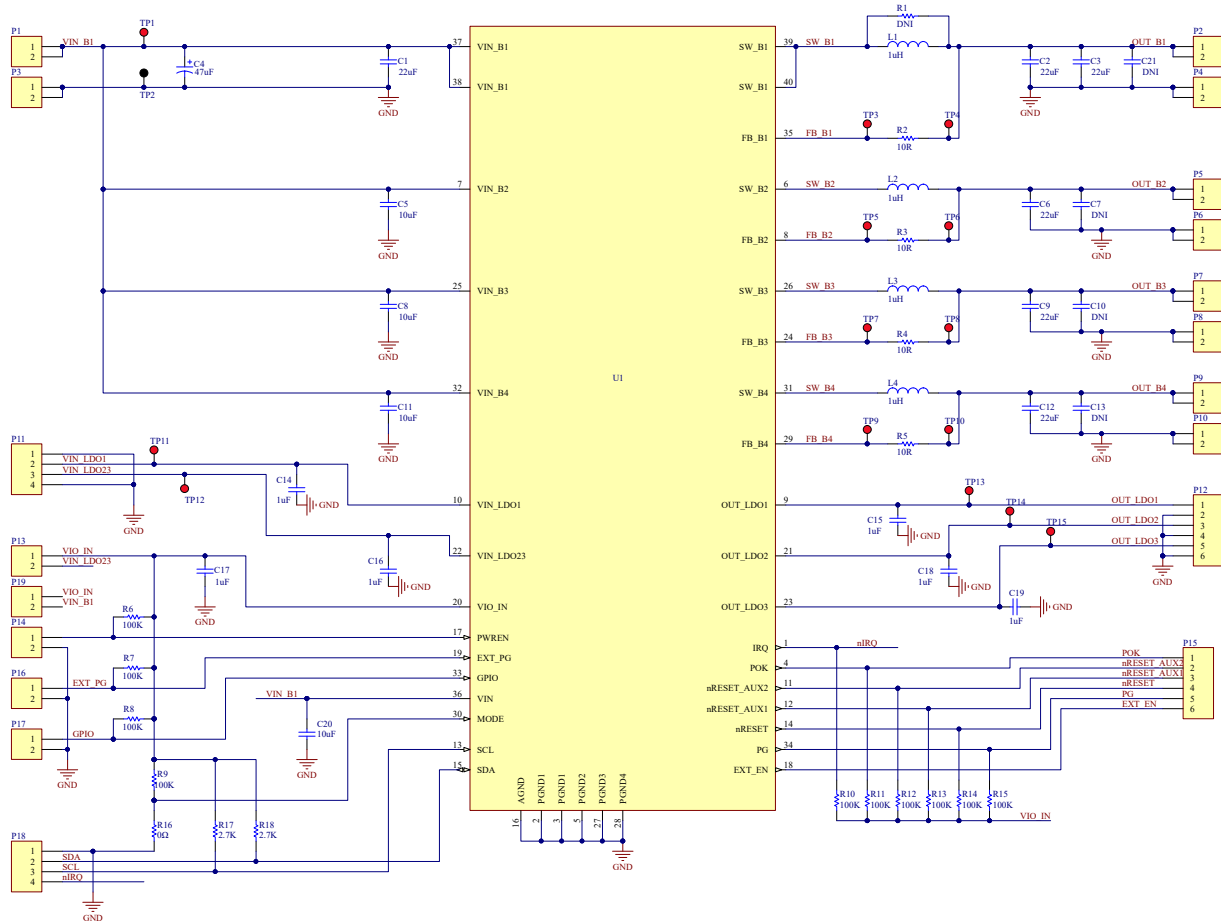

Figure 5 – ACT8870EVK1-102 Schematic

Layout

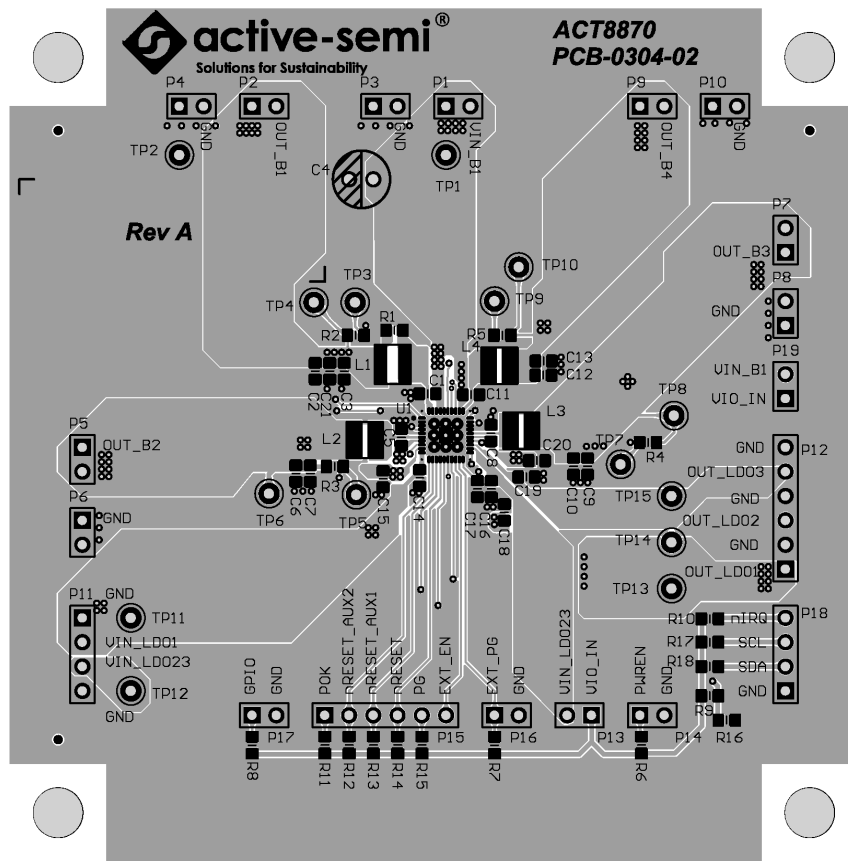

Figure 6 – Layout Top Assembly

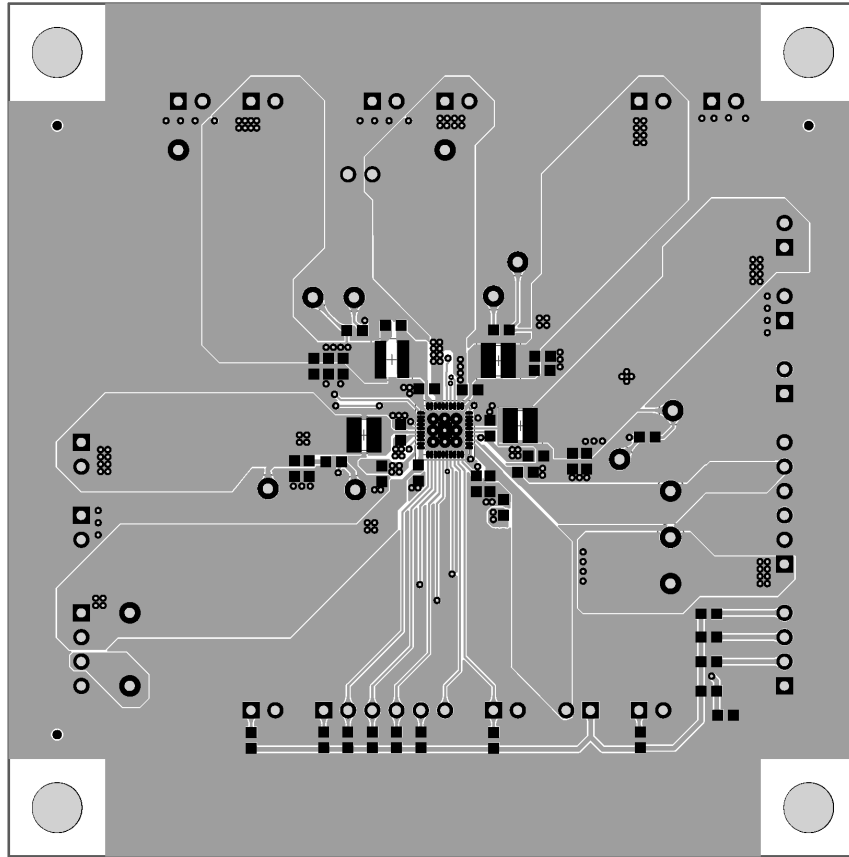

Figure 7 – Layout Top Layer

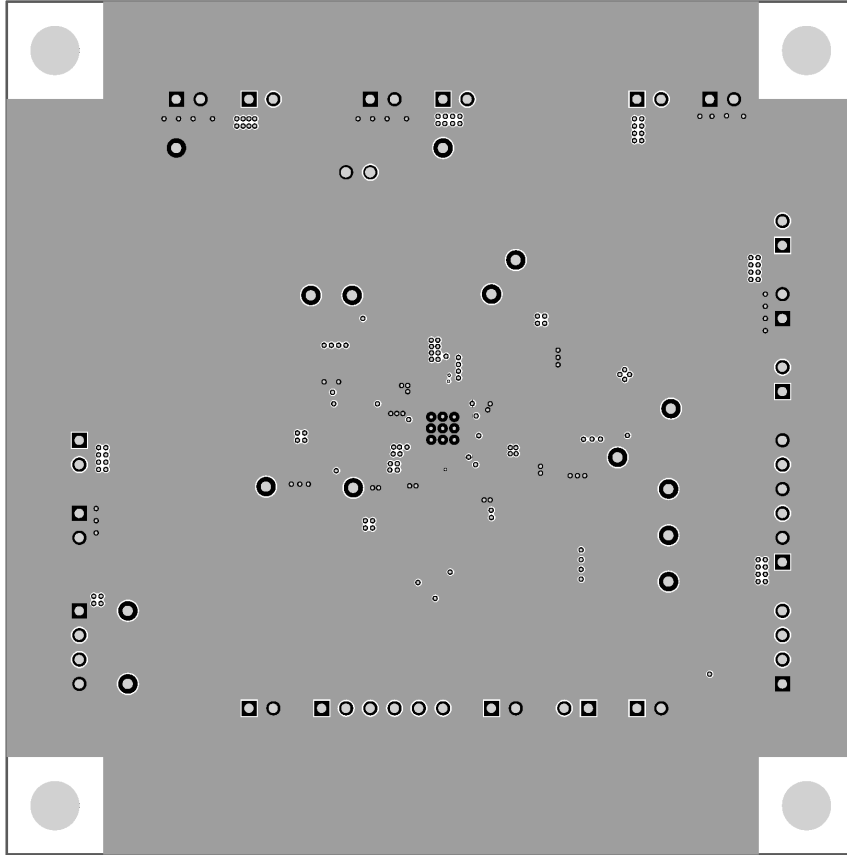

Figure 8 – Layout Layer 2

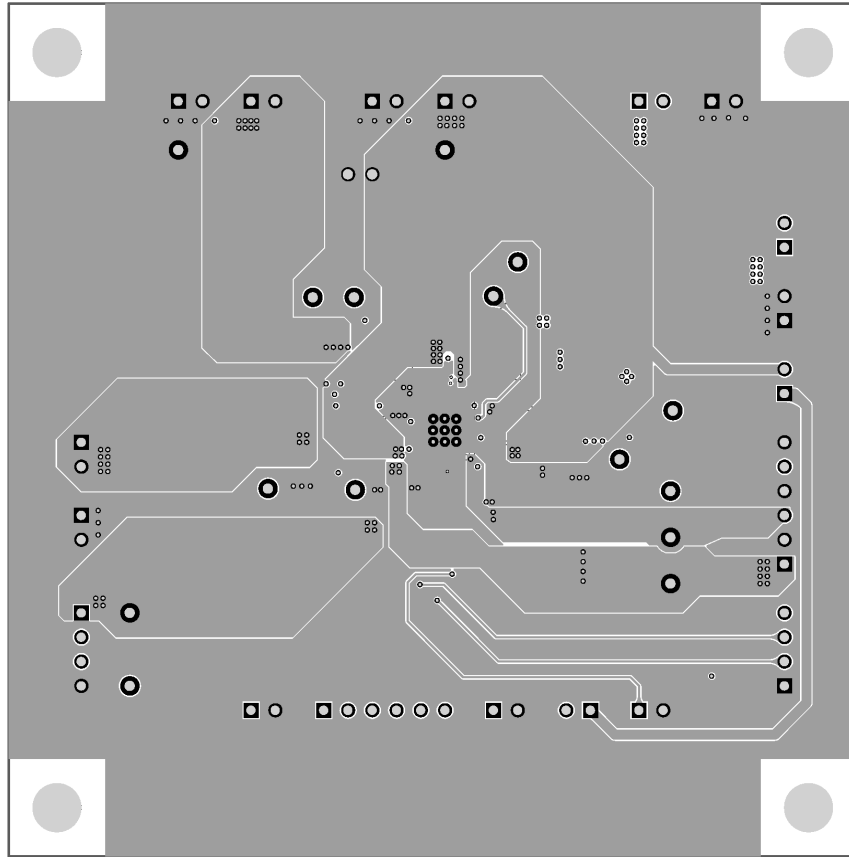

Figure 9 – Layout Layer 3

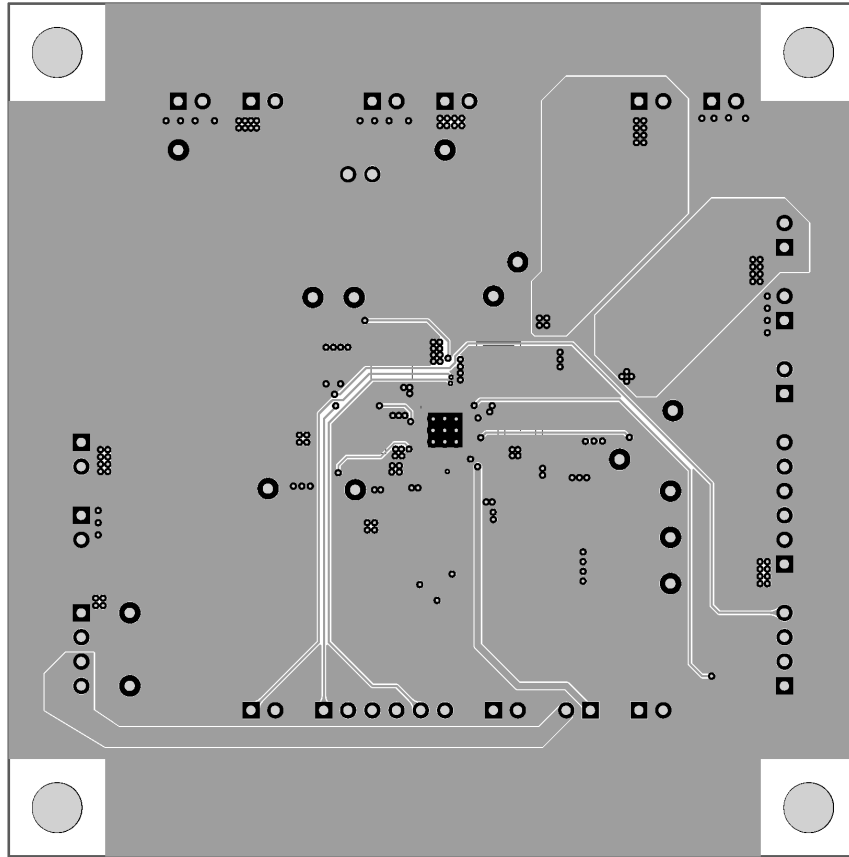

Figure 10 – Layout Bottom Layer

Bill of Materials
Table 2 - BOM

Item	Ref Des	QTY	Description	Package	MFR	Part Number
1	C1,C2,C3,C6,C9,C12,C21	7	Cap, Ceramic, 22uF, 6.3V, 20%, X5R	0603	Samsung	CL10A226MQ8NRNC
2	C5, C8, C11,C20	4	Cap, Ceramic, 10uF, 10V, 10%, X5R	0603	Samsung	CL10A106KP8NNNC
3	C14,C15,C16,C17,C18,C19	6	Cap, Ceramic, 1uF, 25V, 10%, X7R	0603	Yageo	std
4	C4	1	Cap, Aluminium Electrolytic, 470uF, 10V	6.3x11mm	Capxon	KF471M010E110A
5	L1,L2,L3,L4	4	Inductor, 1uH, 7.2A, 12mohm, SMD	4.1 x 4.1 x 2.1mm	Würth Elektronik	74438356010
6	R1	0	Res, 0Ω, 5%	0603	Yageo	std
7	R2,R3,R4,R5	4	Res, 10Ω, 1%	0603	Yageo	std
8	R6,R7,R8,R9,R10,R11,R12, R13,R14,R15	10	Res, 100kΩ, 5%	0603	Yageo	std
9	R16	1	Res, 0Ω, 5%	0603	Yageo	std
10	R17,R18	2	Res, 2.7kΩ, 5%	0603	Yageo	std
11	P1,P2,P3,P4,P5,P6,P7,P8, P9,P10,P13,P14,P16,P17,P19	15	Header, 2 pin, 100mil		Würth Elektronik	61300211121
12	P11,P18	2	Header, 4 pin, 100mil		Würth Elektronik	61300411121
13	P12,P15	2	Header, 6 pin, 100mil		Würth Elektronik	61300611121
14	TP1,TP3,TP4,TP5,TP6,TP7, TP8,TP9,TP10,TP11,TP12, TP13,TP14,TP15	14	Test Point, Red	0.063"	Keystone	5000
15	TP2	1	Test Point, Black	0.063"	Keystone	5001
16	U1	1	IC, ACT8870, PMIC	QFN40	Active-semi	ACT8870QJ102-T
17	--	3	Shorting Jumper	n/a	Würth Elektronik	60900213421
18	--	1	PCB, ACT8870EVK1	n/a	n/a	PCB-0304-02

GUI Installation

1. Contact Active Semi for the GUI files and save them on your computer.
2. Plug the USB-TO-I2C dongle into a free USB port.
3. Follow the instructions in the “How to install driver for dongle” folder.

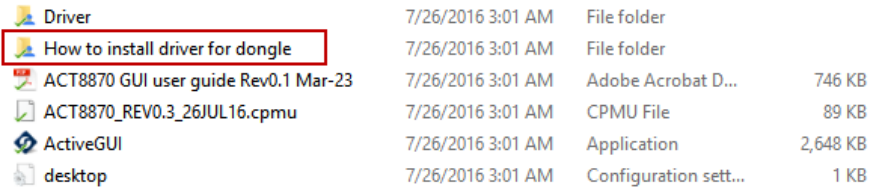







 Driver	7/26/2016 3:01 AM	File folder	
 How to install driver for dongle	7/26/2016 3:01 AM	File folder	
 ACT8870 GUI user guide Rev0.1 Mar-23	7/26/2016 3:01 AM	Adobe Acrobat D...	746 KB
 ACT8870_REV0.3_26JUL16.cpmu	7/26/2016 3:01 AM	CPMU File	89 KB
 ActiveGUI	7/26/2016 3:01 AM	Application	2,648 KB
 desktop	7/26/2016 3:01 AM	Configuration sett...	1 KB

Figure 12 – Dongle Driver

4. Double click on the ACT8870 GUI.exe to start the ACT8870 GUI.

GUI Overview

The GUI has 2 basic function buttons allocated in top-left of the Tool Bar which are Read and Write I2C. The GUI contains 2 setting modes: Basic Mode and Advanced Mode. In Basic Mode screen it displays basic user programmable configuration options are programmed using the drop-down boxes or check boxes. Advanced Mode contain the button text for changing setting for every single bit.

Basic Mode

The following figure show the GUI in basic mode. This mode allows the user to easily change one or more IC settings.

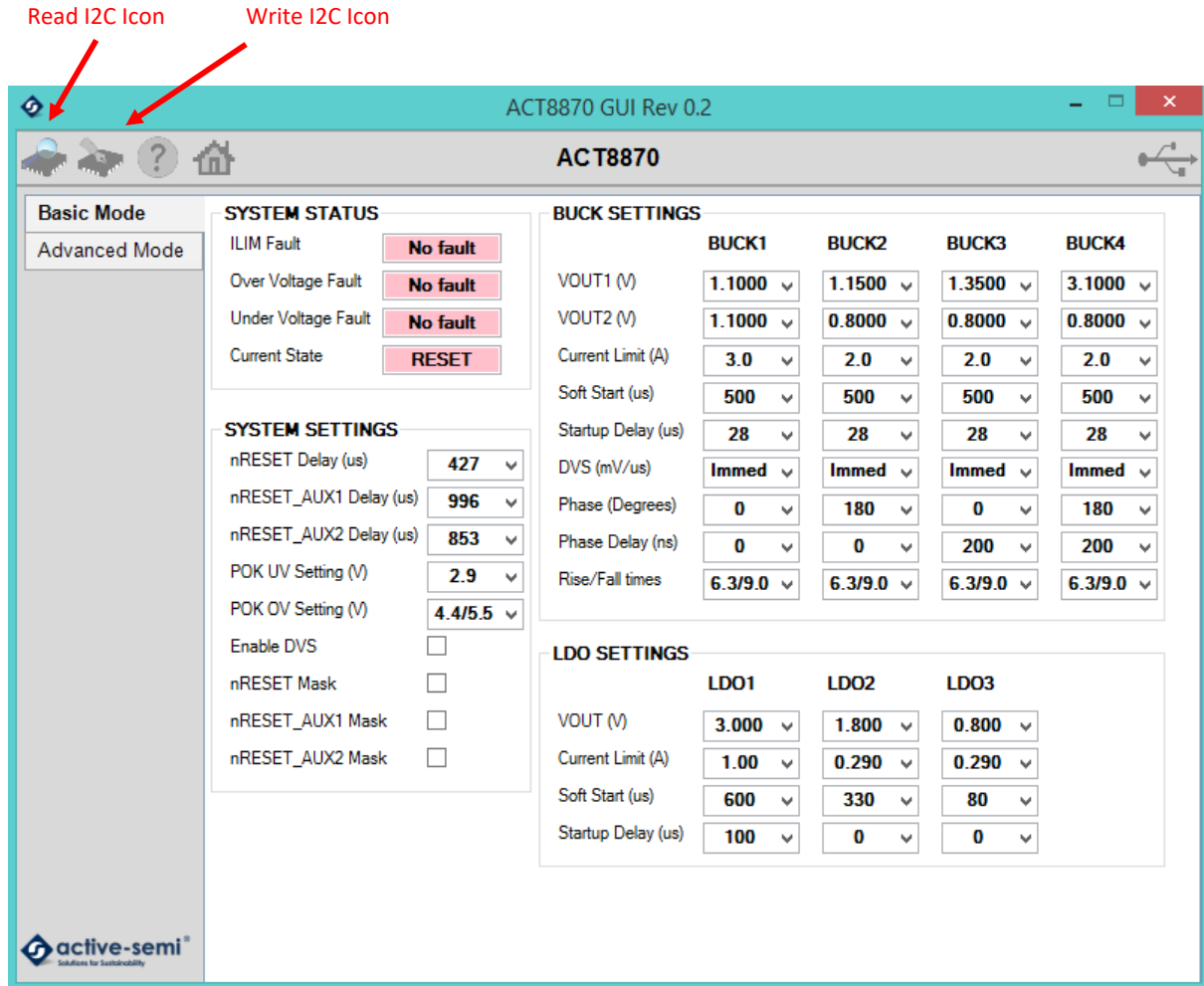

Figure 13 – GUI Basic Mode

Advanced Mode

Click the “Advanced Mode” button in the left of the GUI screen to see all available user programmable options. With Advanced Mode, additional user programmable features can be selected using the button text. In the left side of the Advanced Mode Screen, click on the Tiles Selector to display the register to view or change. Then change a register one bit at a time by clicking on the desired bit. The value of the bit is display right next to the bit-name button.

Note that the far right side of the screen contains a scroll down button to scroll down to additional registers since the Tile Screen can only display up to 8 bytes at once.

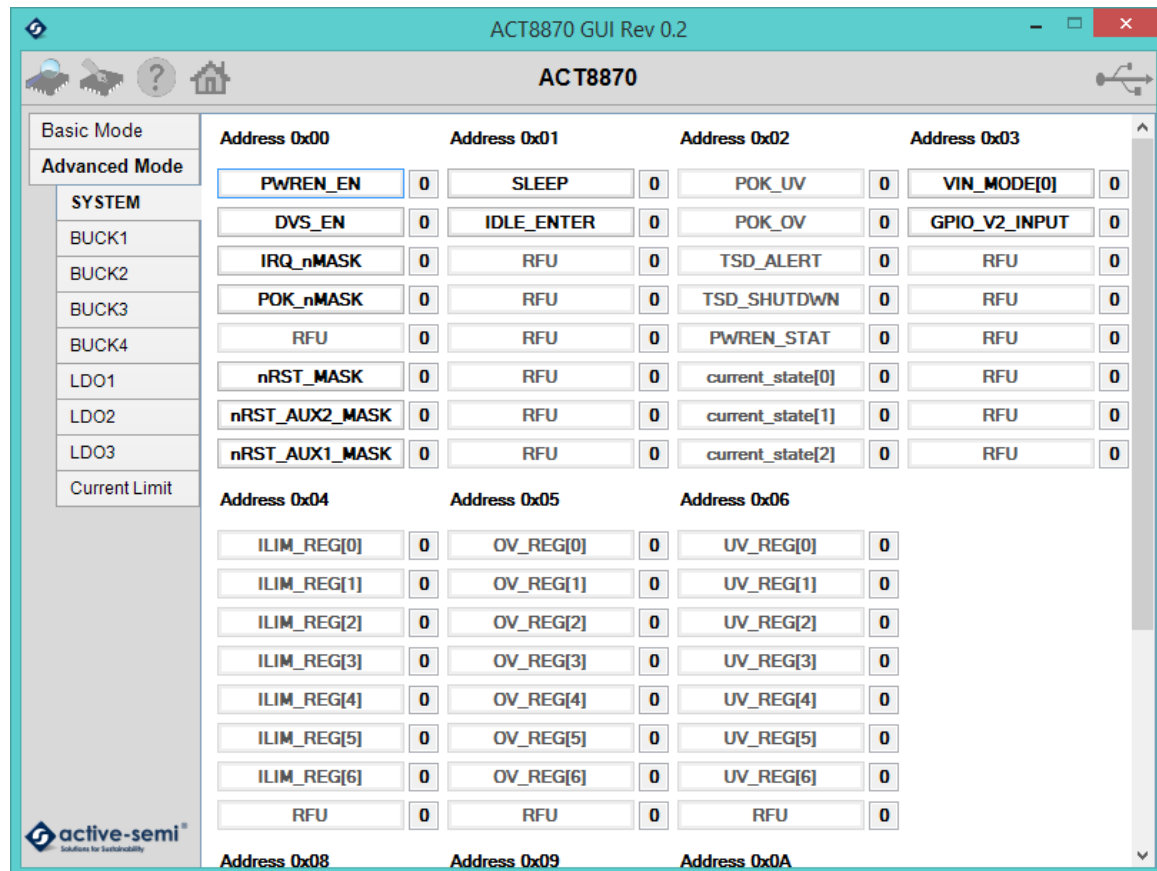

Figure 14 – GUI Advanced Mode

Button Descriptions

Read: Clicking on this button reads the ACT8870 registers and displays them in the GUI. Note that this reads all registers. Active-Semi recommends reading registers each time the ACT8870 powers-up to acquire the initial register settings. Active-semi also recommends reading registers after making changes to them. Immediately reading the registers after a write confirms the changes were properly stored. This also updates the SYSTEM STATUS box to ensure that one of the changes did not generate a fault condition.

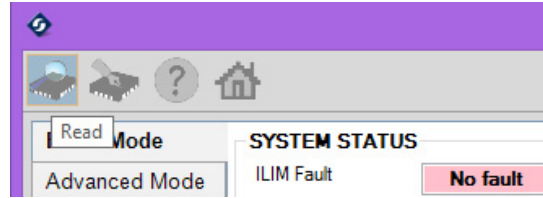

Figure 15 – Read Button

Write: Clicking on this button writes the GUI settings to the ACT8870's registers. All registers are written, regardless of whether or not they were changed.

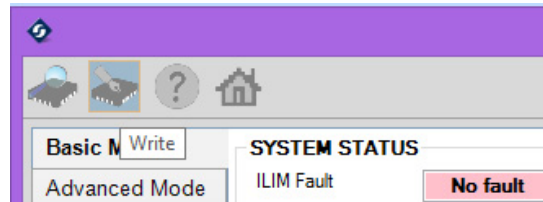

Figure 16 – Write Button

Dongle Connection Status: The GUI also contains a dongle is connected status which indicates that Active-Semi's USB-TO-I2C dongle is connected to the USB port of the driver installed. The figure below shows the two possible indication status graphics.



Figure 17 – Dongle Connection Status