

## FLORENTINA-4X1-O

~45° + 15° oval beam

### TECHNICAL SPECIFICATIONS:

Dimensions	169.7 x 49.7 mm
Height	28.5 mm
Fastening	pin
ROHS compliant	yes 

### MATERIAL SPECIFICATIONS:

Component	Type	Material	Colour	Finish
ROSE-CMC-O	Single lens	PC	clear	
FLORENTINA-4X1-HLD	Holder	PC	black	



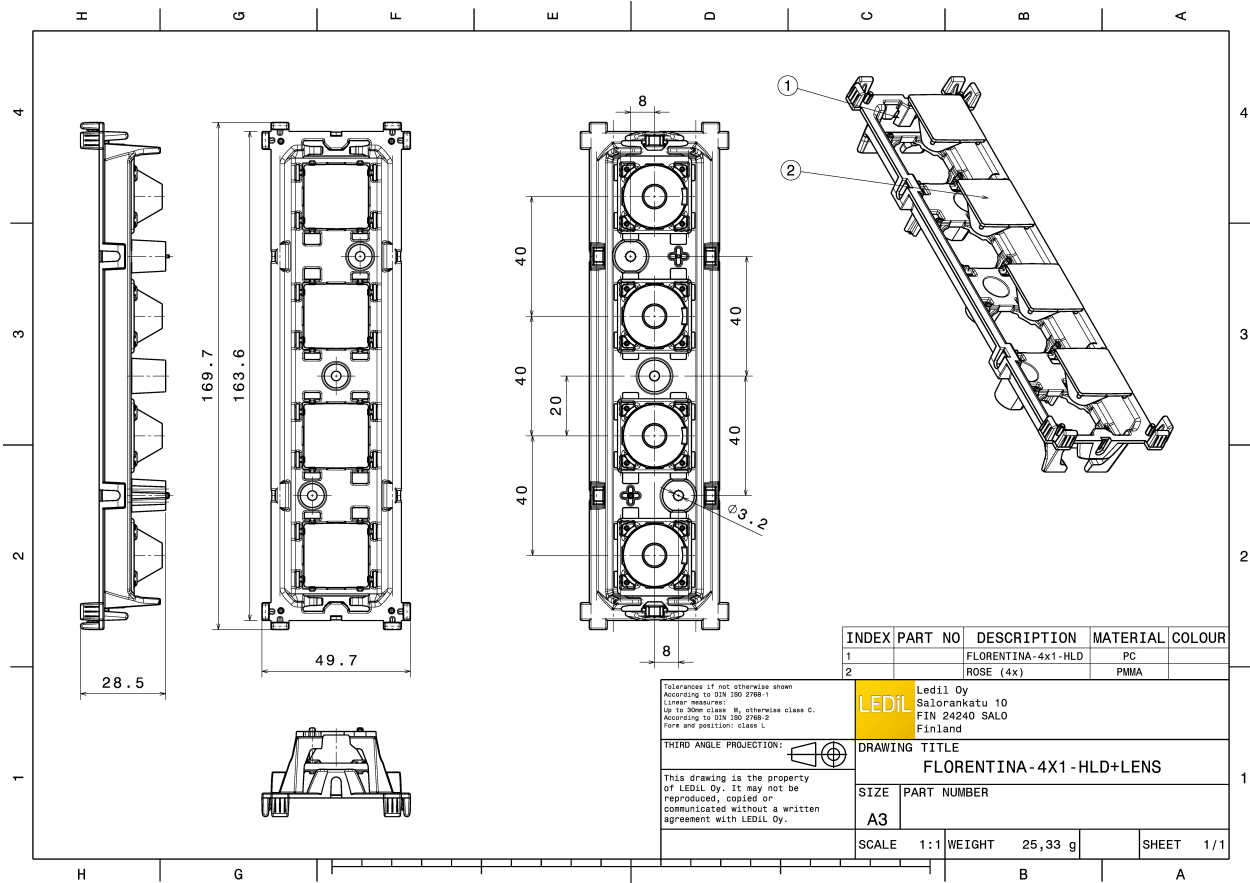

### ORDERING INFORMATION:

Component		Qty in box	MOQ	MPQ	Box weight (kg)
FCP15347_FLORENTINA-4X1-O	Single lens	72	72	8	3.4
» Box size: 476 x 273 x 292 mm					

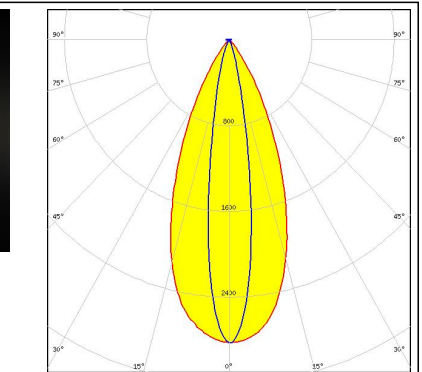

#### PHOTOMETRIC DATA (MEASURED):

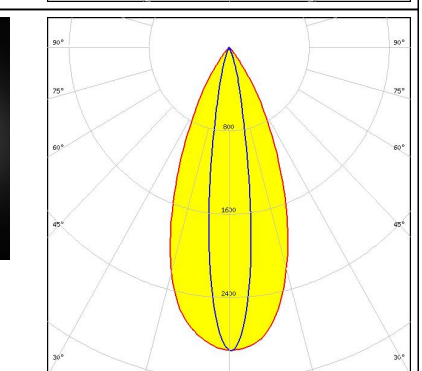
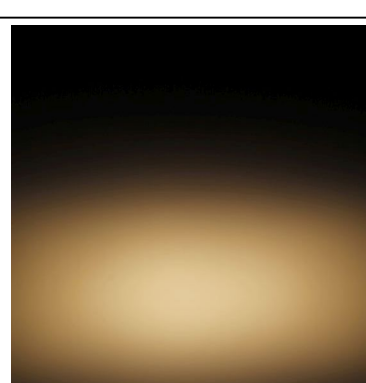
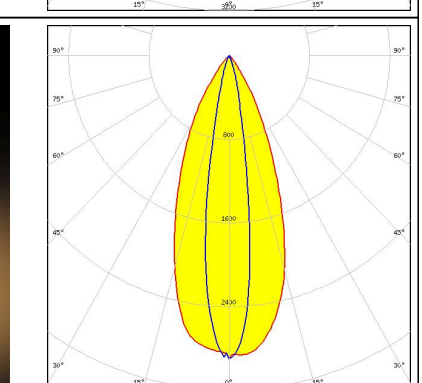
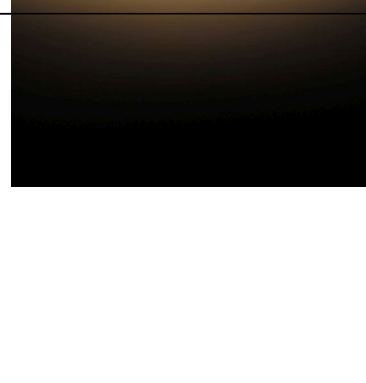
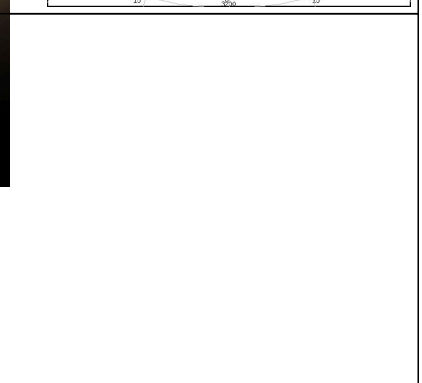
<p><b>COMET ELECTRONICS</b></p> <p>LED EASY-T FLUX 1x4 FLR XG xxx G7            FWHM 43.0 + 16.0°            Efficiency 75 %            Peak intensity 2.8 cd/lm            LEDs/each optic 1            Light colour White            Required components:            C15028_FLORENTINA-4X1-SHD</p>		
<p><b>COMET ELECTRONICS</b></p> <p>LED EASY-T FLUX 1x4 FLR XT xxx G5            FWHM 44.0 + 16.0°            Efficiency 72 %            Peak intensity 2.9 cd/lm            LEDs/each optic 1            Light colour White            Required components:            C15028_FLORENTINA-4X1-SHD</p>		
<p><b>CREE</b></p> <p>LED XP-G2            FWHM 41.0 + 17.0°            Efficiency 71 %            Peak intensity 2.9 cd/lm            LEDs/each optic 1            Light colour White            Required components:            C15028_FLORENTINA-4X1-SHD</p>		
<p><b>CREE</b></p> <p>LED XP-G2            FWHM 41.0 + 17.0°            Efficiency 71 %            Peak intensity 2.9 cd/lm            LEDs/each optic 1            Light colour White            Required components:            C15198_FLORENTINA-4X1-SHD-OPEN</p>		

#### PHOTOMETRIC DATA (MEASURED):



LED XP-L2  
 FWHM 43.0 + 19.0°  
 Efficiency 76 %  
 Peak intensity 2.3 cd/lm  
 LEDs/each optic 1  
 Light colour White  
 Required components:  
 C15690\_FLORENTINA-4X1-SHD-WHT

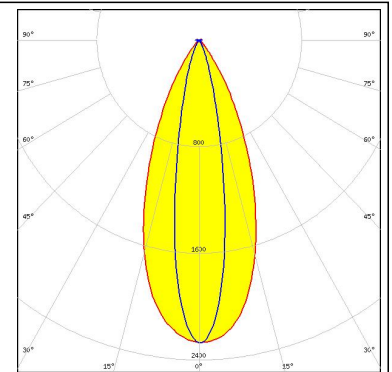
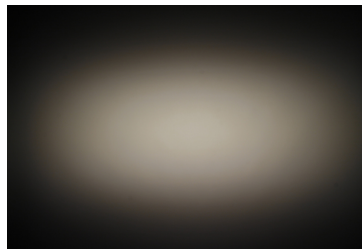

LED XP-L2  
 FWHM 42.0 + 19.0°  
 Efficiency 72 %  
 Peak intensity 2.3 cd/lm  
 LEDs/each optic 1  
 Light colour White  
 Required components:  
 C15198\_FLORENTINA-4X1-SHD-OPEN

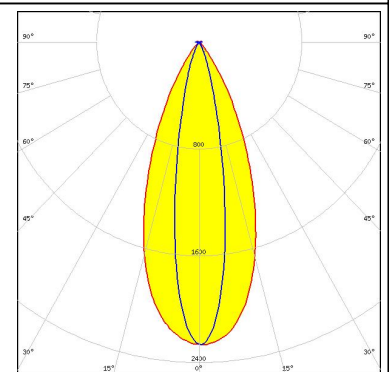
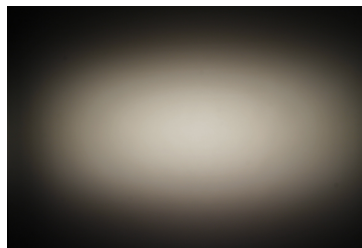

LED XP-L2  
 FWHM 43.0 + 19.0°  
 Efficiency 72 %  
 Peak intensity 2.3 cd/lm  
 LEDs/each optic 1  
 Light colour White  
 Required components:  
 C15028\_FLORENTINA-4X1-SHD

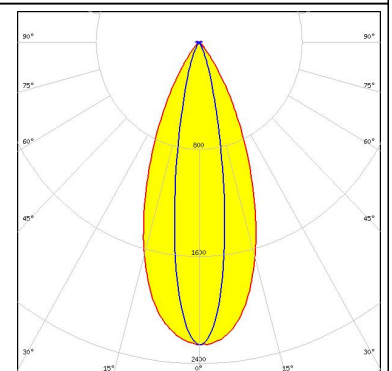
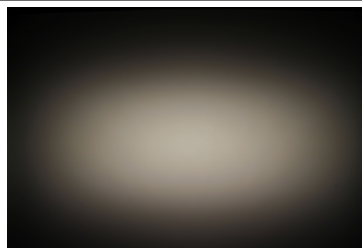

LED NVSxx19B/NVSxx19C  
 FWHM 44.0 + 16.0°  
 Efficiency 78 %  
 Peak intensity 2.9 cd/lm  
 LEDs/each optic 1  
 Light colour White  
 Required components:  
 C15690\_FLORENTINA-4X1-SHD-WHT

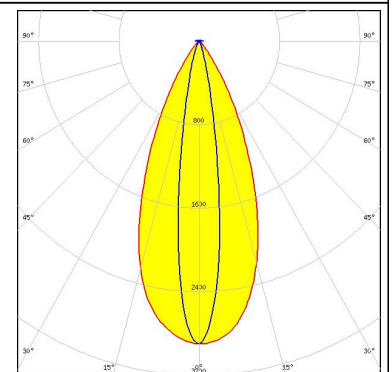
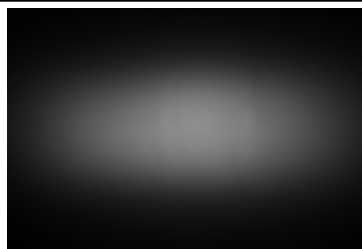

#### PHOTOMETRIC DATA (MEASURED):



LED NVSxx19B/NVSxx19C  
 FWHM 44.0 + 16.0°  
 Efficiency 75 %  
 Peak intensity 2.9 cd/lm  
 LEDs/each optic 1  
 Light colour White  
 Required components:  
 C15198\_FLORENTINA-4X1-SHD-OPEN

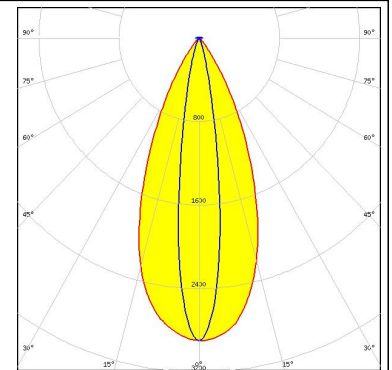

LED NVSxx19B/NVSxx19C  
 FWHM 44.0 + 16.0°  
 Efficiency 79 %  
 Peak intensity 2.9 cd/lm  
 LEDs/each optic 1  
 Light colour White  
 Required components:  
 C15028\_FLORENTINA-4X1-SHD

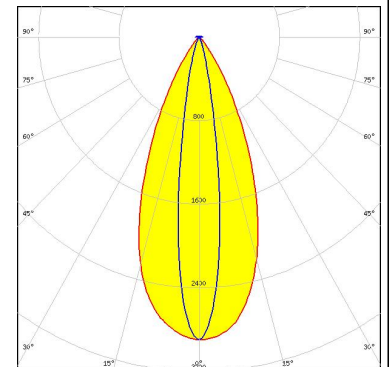

LED OSLOM Square CSSRM2/CSSRM3  
 FWHM 44.0 + 15.0°  
 Efficiency 69 %  
 Peak intensity 3 cd/lm  
 LEDs/each optic 1  
 Light colour White  
 Required components:  
 C15198\_FLORENTINA-4X1-SHD-OPEN

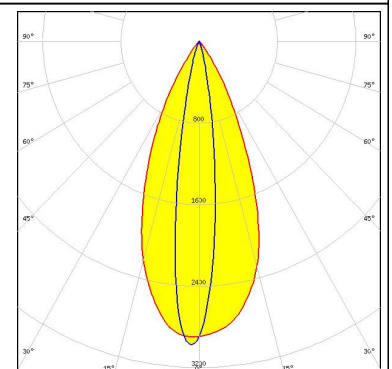
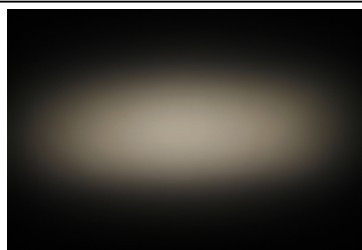

LED OSLOM Square CSSRM2/CSSRM3  
 FWHM 44.0 + 15.0°  
 Efficiency 74 %  
 Peak intensity 3 cd/lm  
 LEDs/each optic 1  
 Light colour White  
 Required components:  
 C15028\_FLORENTINA-4X1-SHD

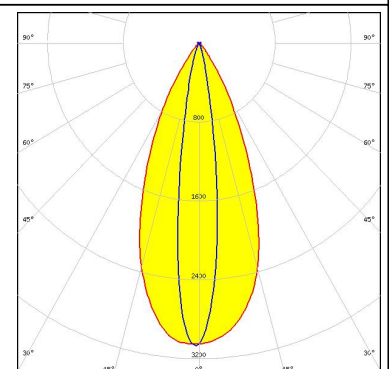
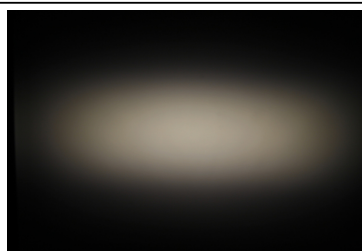

#### PHOTOMETRIC DATA (SIMULATED):



LED XP-L HD  
FWHM 10.0 + 25.0°  
Efficiency 198 %  
Peak intensity 2.5 cd/lm  
LEDs/each optic 1  
Light colour White  
Required components:  
C15028\_FLORENTINA-4X1-SHD

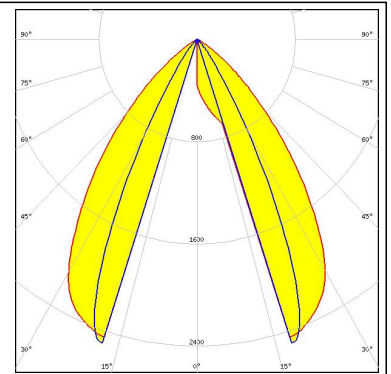



#### GENERAL INFORMATION:

NOTE: The typical beam angle will be changed by different color, chip size and chip position tolerance. The typical total beam angle is the full angle measured where the luminous intensity is half of the peak value.

#### MATERIALS:

As part of our continuous research and improvement processes, and to ensure the best possible quality and availability of our products, LEDiL reserves the right to change material grades without notice.

#### PRODUCT DATA USER AGREEMENT AND DISCLAIMER:

The measured data in the provided downloadable LEDiL Product Datasheets and Mechanical 2D-Drawings is rounded and provided as reference for planning. LEDiL Oy's optical specifications have been verified by conducting performance testing of the products in accordance with the company's quality system. The reported data are averaged results of multiple measurements with typical variation. LEDiL Oy reserves the right to without prior notification make changes and improvements to its products.

LEDiL Oy assumes neither warranty, nor guarantee nor any other liability of any kind for the contents and correctness of the provided data. The provided data has been generated with highest diligence but the provided data may in reality not represent the complete possible variation range of all intrinsic parameters. Therefore, in certain cases a deviation from the provided data could occur.

LEDiL Oy reserves the right to undertake technical changes of its products without further notification which could lead to changes in the provided data. LEDiL Oy assumes no liability of any kind for the possible deviation from any provided data or any other damage resulting from the usage of the provided data.

The user agrees to this disclaimer and user agreement with the download or usage of the provided files.

#### LEDiL Oy

Joensuunkatu 13  
FI-24240 SALO  
Finland

#### LEDiL Inc.

228 West Page Street  
Suite D  
Sycamore IL 60178  
USA

#### Local sales and technical support

[www.ledil.com/  
where\\_to\\_buy](http://www.ledil.com/where_to_buy)

#### Shipping locations

Salo, Finland  
Hong Kong, China

#### Distribution Partners

[www.ledil.com/  
where\\_to\\_buy](http://www.ledil.com/where_to_buy)