

# E3Z-L

## Small 2.5-mm-diameter Spot Ideal for Detecting Small Workpieces

- Tiny workpieces as little as 0.1 mm in diameter can be detected with the 2.5-mm-dia. spot.
- The narrow beam enables sensing from small slots or holes.
- The small spot of light enables visual checking of sensing spot position.
- IP67 degree of protection, mutual interference prevention, and EN standard compliance.





 Be sure to read *Safety Precautions* on page 4.

## Ordering Information

### Sensors

 Infrared light

Sensing method	Appearance	Connection method	Sensing distance	Model	
				NPN output	PNP output
Narrow-beam reflective		Pre-wired	 90±30 mm	E3Z-L61 *	E3Z-L81
		Connector (M8, 4pins)		E3Z-L66	E3Z-L86

\* The following table shows the model numbers of e-CON Pre-wired Connectors that are available. The Ratings and Specifications are the same as those for the E3Z-L61.

Cable length	Model
0.3 m	E3Z-L61-ECON 0.3M
0.5 m	E3Z-L61-ECON 0.5M
2 m	E3Z-L61-ECON 2M

### Accessories (Order Separately)

[Mounting Brackets](#)

[Sensor I/O Connectors](#)

## Ratings and Specifications

Item	Sensing method		Narrow-beam reflective	
	Model	NPN output	E3Z-L61	E3Z-L66
		PNP output	E3Z-L81	E3Z-L86
Sensing distance	White paper (100 × 100 mm): 90±30 mm			
Spot diameter (typical)	2.5-mm dia. min. (at sensing distance of 90 mm)			
Minimum detectable object (typical)	0.1-mm dia. (copper wire)			
Differential travel (typical)	Refer to <i>Differential Travel vs. Sensing Distance</i> on page 2.			
Light source (wavelength)	Red LED (650 nm)			
Power supply voltage	12 to 24 VDC ±10%, ripple (p-p): 10% max.			
Current consumption	30 mA max.			
Control output	Load power supply voltage: 26.4 V max.; Load current: 100 mA max. Residual voltage: Load current of less than 10 mA: 1 V max. Load current of 10 to 100 mA: 2 V max. Open collector output (NPN or PNP depending on model) Light-ON/Dark-ON selectable			
Protection circuits	Power supply reverse polarity protection, Output short-circuit protection, Mutual interference prevention, Reverse output polarity protection			
Response time	Operate or reset: 1 ms max.			
Sensitivity adjustment	One-turn adjuster			
Ambient illumination (Receiver side)	Incandescent lamp: 3,000 lx max., Sunlight: 10,000 lx max.			
Ambient temperature range	Operating: -25 to 55°C, Storage: -40 to 70°C (with no icing or condensation)			
Ambient humidity range	Operating: 35 to 85%, Storage: 35 to 95% (with no condensation)			
Insulation resistance	20 MΩ min. at 500 VDC			
Dielectric strength	1,000 VAC 50/60 Hz for 1 min			
Vibration resistance	Destruction: 10 to 55 Hz, 1.5-mm double amplitude for 2 hours each in X, Y, and Z directions.			
Shock resistance	Destruction: 500m/s <sup>2</sup> 3 times each in the X, Y, and Z directions			
Degree of protection	IP67 (IEC 60529)			
Connection method	Pre-wired (standard length: 2 m and 0.5 m)		Connector (M8, 4 pins)	
Indicators	Operation indicator (orange), Stability indicator (green)			
Weight (packed state)	Pre-wired type, 2 m: Approx. 65 g		Approx. 20 g	
Material	Case	PBT (polybutylene terephthalate)		
	Lens	Modified polyarylate		
Accessories	Instruction manual (Mounting Brackets must be ordered separately.)			

## Engineering Data

## Operating Range

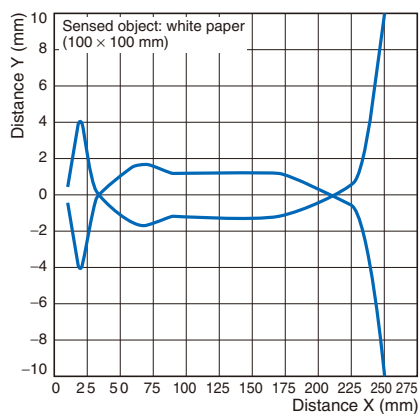

## Excess Gain vs. Sensing Distance

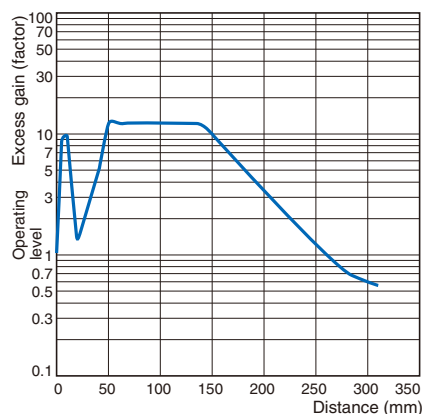

## Sensing Object Size vs. Sensing Distance

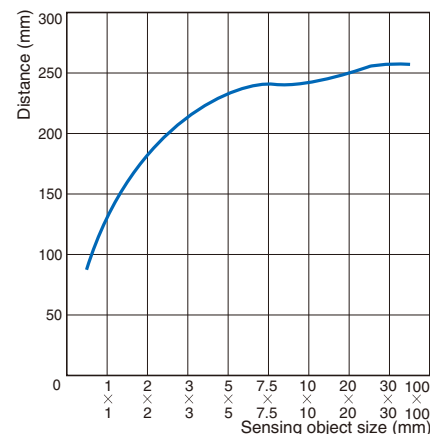

## Spot Diameter vs. Sensing Distance

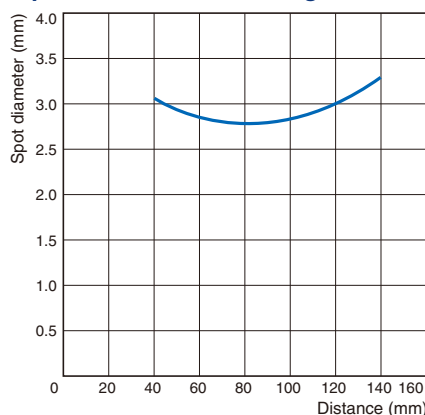

## Differential Travel vs. Sensing Distance

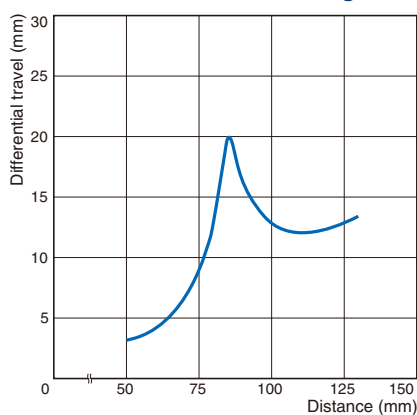

## I/O Circuit Diagrams

### NPN Output

Model	Operation mode	Timing charts	Operation selector	Output circuit
E3Z-L61 E3Z-L66	Light-ON	Incident light: ON (High pulse) No incident light: OFF (Low) Operation indicator (orange): ON (High pulse) OFF (Low) Output transistor: ON (High pulse) OFF (Low) Load (e.g., relay): Operate (High pulse) Reset (Between brown and black leads)	L side (LIGHT ON)	<b>Narrow-beam Reflective Models</b> 
	Dark-ON	Incident light: OFF (Low) No incident light: ON (High pulse) Operation indicator (orange): ON (High pulse) OFF (Low) Output transistor: ON (High pulse) OFF (Low) Load (e.g., relay): Operate (High pulse) Reset (Between brown and black leads)	D side (DARK ON)	<b>Connector Pin Arrangement</b>  Pin 2 is not used.

### PNP Output

Model	Operation mode	Timing charts	Operation selector	Output connector
E3Z-L81 E3Z-L86	Light-ON	Incident light: ON (High pulse) No incident light: OFF (Low) Operation indicator (orange): OFF (Low) ON (High pulse) Output transistor: OFF (Low) Operate (High pulse) Load (e.g., relay): Operate (High pulse) Reset (Between brown and black leads)	L side (LIGHT ON)	<b>Narrow-beam Reflective Models</b> 
	Dark-ON	Incident light: OFF (Low) No incident light: ON (High pulse) Operation indicator (orange): ON (High pulse) OFF (Low) Output transistor: ON (High pulse) OFF (Low) Load (e.g., relay): Operate (High pulse) Reset (Between brown and black leads)	D side (DARK ON)	<b>Connector Pin Arrangement</b>  Pin 2 is not used.

### Plugs (Sensor I/O Connectors)

Wire color  
Brown  
White  
Blue  
Black

E39-ECONM  
E39-ECONWM

Classification	Wire color	Connector pin No.	Application
DC	Brown	1	Power supply (+V)
	White	2	---
	Blue	3	Power supply (0 V)
	Black	4	Output

Note: Pin 2 is not used.

## Safety Precautions

Refer to *Warranty and Limitations of Liability*.

### WARNING

This product is not designed or rated for ensuring safety of persons either directly or indirectly. Do not use it for such purposes.



### Precautions for Correct Use

Do not use the product in atmospheres or environments that exceed product ratings.

## Dimensions

(Unit: mm)

### Sensors

#### Pre-wired Models

E3Z-L61

E3Z-L81

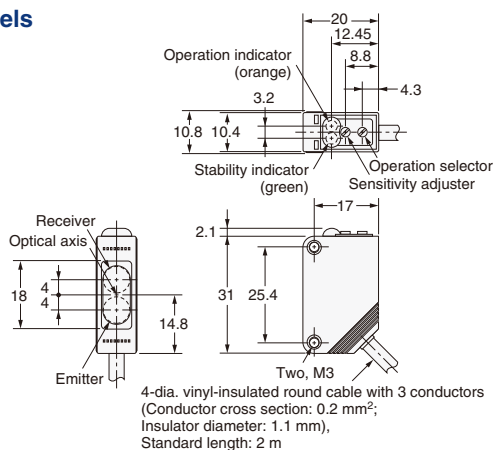

#### e-CON Pre-wired Connector

Connector: Model No.37104-3122-000FL  
Sumitomo 3M

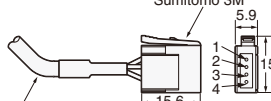

\* 4-dia. vinyl-insulated round cable with 3 conductors, Standard lengths: 0.3 m, 0.5 m, and 2 m

#### Connector Models

E3Z-L66

E3Z-L86

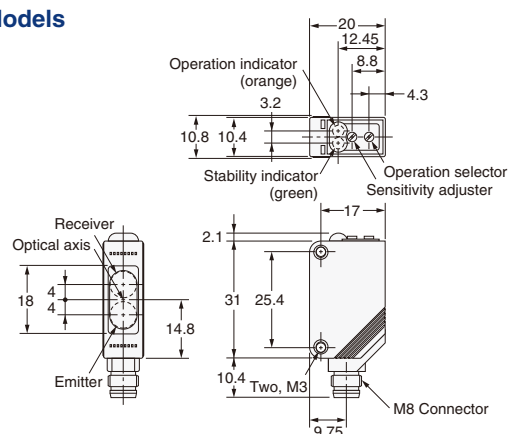

## Accessories (Order Separately)

### Mounting Brackets

# Photoelectric Sensors Technical Guide

## General Precautions

For precautions on individual products, refer to *Safety Precautions* in individual product information.

### ⚠ WARNING

These Sensors cannot be used in safety devices for presses or other safety devices used to protect human life. These Sensors are designed for use in applications for sensing workpieces and workers that do not affect safety.



### Precautions for Safe Use

To ensure safety, always observe the following precautions.

### ● Wiring

Item	Typical examples	
<p><b>Power Supply Voltage</b></p> <p>Do not use a voltage in excess of the operating voltage range. Applying a voltage in excess of the operating voltage range, or applying AC power (100 VAC or greater) to a DC Sensor may cause explosion or burning.</p>	<p>• DC Three-wire NPN Output Sensors</p>	---
<p><b>Load Short-circuiting</b></p> <p>Do not short-circuit the load. Doing so may cause explosion or burning.</p>	<p>• DC Three-wire NPN Output Sensor</p>	<p>• AC Two-wire Sensors Example: E3E2</p>
<p><b>Incorrect Wiring</b></p> <p>Do not reverse the power supply polarity or otherwise wire incorrectly. Doing so may cause explosion or burning.</p>	<p>• DC Three-wire NPN Output Sensors Example: Incorrect Polarity</p>	<p>• DC Three-wire NPN Output Sensors Example: Incorrect Polarity Wiring</p>
<p><b>Connection without a load</b></p> <p>If the power supply is connected directly without a load, the internal elements may burst or burn. Be sure to insert a load when connecting the power supply.</p>	<p>• DC Three-wire NPN Output Sensors</p>	<p>• AC 2-wire Sensors Example: E3E2 etc.</p>

### ● Operating Environment

- (1) Do not use a Sensor in an environment where there are explosive or inflammable gases.
- (2) Do not use the Sensor in environments where the cables may become immersed in oil or other liquids or where liquids may penetrate the Sensor. Doing so may result in damage from burning and fire, particularly if the liquid is flammable.

## Precautions for Correct Use

### ● Design

#### Power Reset Time

The Sensor will be ready to detect within approximately 100 ms after the power is turned ON.

If the Sensor and the load are connected to separate power supplies, turn ON the Sensor power before turning ON the load power. Any exceptions to this rule are indicated in *Safety Precautions* in individual product information.

#### Turning OFF Power

An output pulse may be generated when the power is turned OFF. It is recommended that the load or load line power be turned OFF before the Sensor power is turned OFF.

#### Power Supply Types

An unsmoothed full-wave or half-wave rectifying power supply cannot be used.

### Mutual Interference

Mutual interference is a state where an output is unstable because the Sensors are affected by light from the adjacent Sensors. The following measures can be taken to avoid mutual interference.

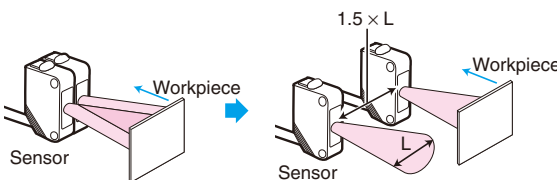
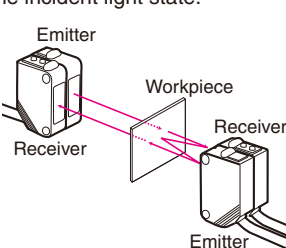
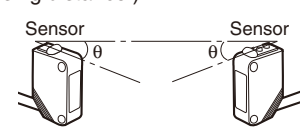
Counter-measure	Concept	Through-beam Sensors	Reflective Sensors
1	Use a Sensor with the interference prevention function.	If Sensors are mounted in close proximity, use Sensors with the interference prevention function. 10 or fewer Sensors: E3X-DA□-S, E3X-MDA, E3C-LDA Fiber Sensors Performance, however, will depend on conditions. Refer to pages E3X-DA-S/E3X-MDA and E3C-LDA. 5 or fewer Sensors: E3X-NA Fiber Sensors 2 or fewer Sensors: E3T, E3Z, E3ZM, E3ZM-C, E3S-C, E3G-L1/L3, or E3S-C Built-in Amplifier Photoelectric Sensors (except Through-beam Sensors) E3C Photoelectric Sensor with separate amplifier	
2	Install an inference prevention filter.	A mutual interference prevention polarizing filter can be installed on only the E3Z-TA to allow close-proximity mounting of up to 2 Sensors. Mutual Interference Prevention Polarizing Filter: E39-E11	---
3	Separate Sensors to distance where interference does not occur.	Check the parallel movement distance range in the catalog, verify the set distance between adjacent Sensors, and install the Sensors accordingly at a distance at least 1.5 times the parallel movement distance range.	If the workpieces move from far to near, chattering may occur in the vicinity of the operating point. For this type of application, separate the Sensors by at least 1.5 times the operating range. 
4	Alternate Emitters and Receivers.	Close mounting of Sensors is possible by alternating the Emitters with the Receivers in a zigzag fashion (up to two Sensors). However, if the workpieces are close to the Photoelectric Sensors, light from the adjacent Emitter may be received and cause the Sensor to change to the incident light state. 	---
5	Offset the optical axes.	If there is a possibility that light from another Sensor may enter the Receiver, change the position of the Emitter and Receiver, place a light barrier between the Sensors, or take other measures to prevent the light from entering the Receiver. (Light may enter even if the Sensors are separated by more than the sensing distance.)	If Sensors are mounted in opposite each other, slant the Sensors as shown in the following diagram. (This is because the Sensors may affect each other and cause output chattering even if separated by more than the Sensor sensing distance.) 
6	Adjust the sensitivity.	Lowering the sensitivity will generally help.	

# Photoelectric Sensors Technical Guide

## Noise

Countermeasures for noise depend on the path of noise entry, frequency components, and wave heights. Typical measures are as given in the following table.

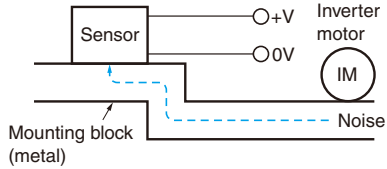
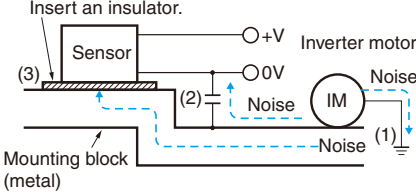
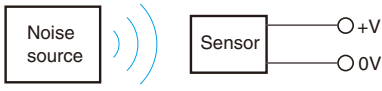
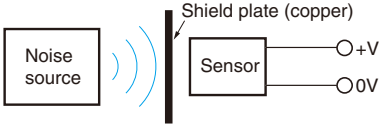
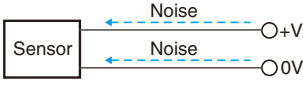
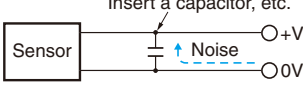
Type of noise	Noise intrusion path and countermeasure	
	Before countermeasure	After countermeasure
<b>Common mode noise (inverter noise)</b> (Common noise applied between the mounting board and the +V and 0-V lines, respectively.)	Noise enters from the noise source through the frame (metal). 	<ol style="list-style-type: none"> <li>Ground the inverter motor (to 100 Ω or less)</li> <li>Ground the noise source and the power supply (0-V side) through a capacitor (film capacitor, 0.22 μF, 630 V).</li> <li>Insert an insulator (plastic, rubber, etc.) between the Sensor and the mounting plate (metal).</li> </ol> 
<b>Radiant noise</b> (Ingress of high-frequency electromagnetic waves directly into Sensor, from power line, etc.)	Noise propagates through the air from the noise source and directly enters the Sensor. 	<ul style="list-style-type: none"> <li>Insert a shield (copper) plate between the Sensor and the noise source e.g., a switching power supply).</li> <li>Separate the noise source and the Sensor to a distance where noise does not affect operation.</li> </ul> 
<b>Power line noise</b> (Ingress of electromagnetic induction from high-voltage wires and switching noise from the switching power supply)	Noise enters from the power line. 	<ul style="list-style-type: none"> <li>Insert a capacitor (e.g., a film capacitor), noise filter (e.g., ferrite core or insulated transformer), or varistor in the power line.</li> </ul> 

## ● Wiring

### Cable

Unless otherwise indicated, the maximum length of cable extension is 100 m using wire that is 0.3 mm<sup>2</sup> or greater.

Exceptions are indicated in **Safety Precautions** in individual product information.

### Cable Tensile Strength

When wiring the cable, do not subject the cable to a tension greater than that indicated in the following table.

Cable diameter	Tensile strength
Less than 4 mm	30 N max.
4 mm or greater	50 N max.

Note: Do not subject a shielded cable or coaxial cable to tension.

### Repeated Bending

Normally, the Sensor cable should not be bent repeatedly. (For bending-resistant cable, see **Attachment to Moving Parts** on page C-4.)

### Separation from High Voltage (Wiring Method)

Do not lay the cables for the Sensor together with high-voltage lines or power lines. Placing them in the same conduit or duct may cause damage or malfunction due to induction interference. As a general rule, wire the Sensor in a separate system, use an independent metal conduit, or use shielded cable.

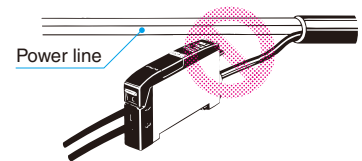

### Work Required for Unconnected Leads

Unused leads for self-diagnosis outputs or other special functions should be cut and wrapped with insulating tape to prevent contact with other terminals.

## Power Supply

When using a commercially available switching regulator, ground the FG (frame ground) and G (ground) terminals. If not grounded, switching noise in the power supply may cause malfunction.

## Example of Connection with S3D2 Sensor Controller

### DC Three-wire NPN Output Sensors

Reverse operation is possible using the signal input switch on the S3D2.

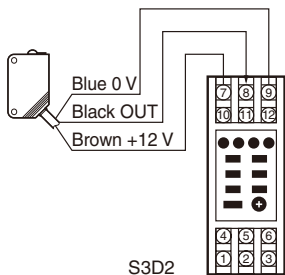

## ● Mounting

### Attachment to Moving Parts

To mount the Photoelectric Sensor to a moving part, such as a robot hand, consider using a Sensors that uses a bending-resistant cable (robot cable).

Although the bending repetition tolerance of a standard cable is approximately 13,000 times, robot cable has an excellent bending tolerance of approximately 500,000 times.

### Cable Bending Destruction Test (Tough Wire Breaking Test)

With current flowing, bending is repeated to check the number of bends until the current stops.

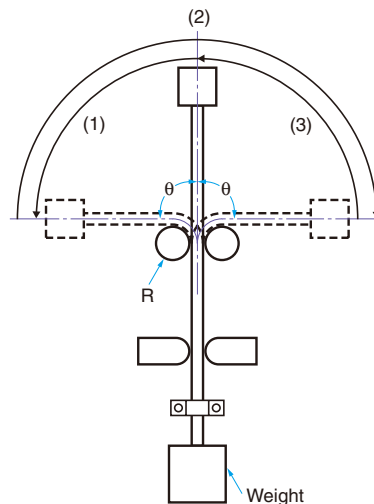

Specimen		Standard cable VR (H) 3 x18/0.12	Robot cable: Strong, conductive electrical wire 2 x 0.15 mm <sup>2</sup> , shielded
Description/conditions	Bending angle ( $\theta$ )	Left/right 90° each	Left/right 45° each
	Bending repetitions	---	60 bends/minute
	Weight	300g	200g
	Operation per bending	(1) through (3) in figure once	(1) through (3) in figure once
	Bending radius of support points (R)	5 mm	2.5 mm
Result		Approx. 13,000 times	Approx. 500,000 times

The testing conditions of the standard cable and robot cable are different.

Refer to the values in the above table to check bend-resistant performance under actual working conditions.



## Securing Fibers

The E3X Fiber Unit uses a one-touch locking mechanism. Use the following methods to attach and remove Fiber Units.

### (1) Attaching Fibers

Open the protective cover, insert the fiber up to the insertion mark on the side of the Fiber Unit, and then lower the lock lever.

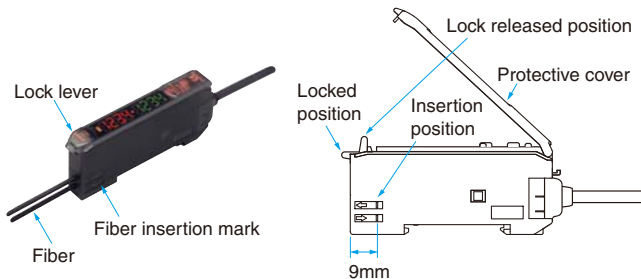

### (2) Removing Fibers

Open the protective cover, lift up the lock lever, and pull out the fibers.

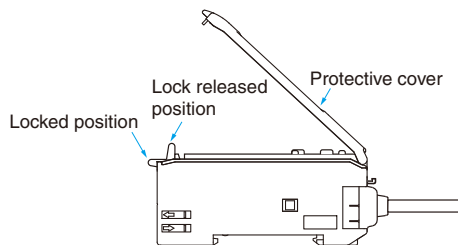

Note: 1. To maintain the fiber characteristics, make sure that the lock is released before removing the fibers.  
 2. Lock and unlock the fibers at an ambient temperature of  $-10$  to  $40^{\circ}\text{C}$ .

## ● Adjustments

### Optical Axis Adjustment

Move the Photoelectric Sensor both vertically and horizontally and set it in the center of the range in which the operation indicator is lit or not lit. For the E3S-C, the optical axis and the mechanical axis are the same, so the optical axis can be easily adjusted by aligning the mechanical axis.

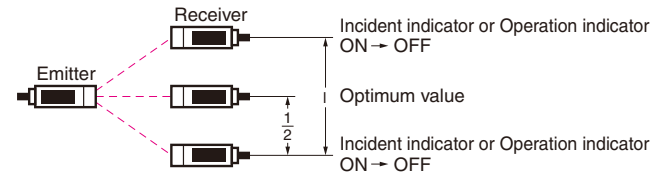

**Optical axis:** The axis from the center of the lens to the center of the beam for the Emitter and the axis from the center of the lens to the center of the reception area for the Receiver.

**Mechanical axis:** The axis perpendicular to the center of the lens.

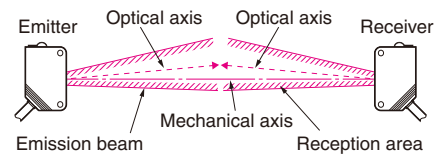

## ● Operating Environment

### Water Resistance

Do not use in water, in rain, or outside.

### Ambient Conditions

Do not use this Sensor in the following locations. Otherwise, it may malfunction or fail.

- (1) Locations exposed to excessive dust and dirt
- (2) Locations exposed to direct sunlight
- (3) Locations with corrosive gas vapors
- (4) Locations where organic solvents may splash onto the Sensor
- (5) Locations subject to vibration or shock
- (6) Locations where there is a possibility of direct contact with water, oil, or chemicals
- (7) Locations with high humidity and where condensation may result

### Environmentally Resistive Sensors

The E32-T11F/T12F/T14F/T81F-S/D12F/D82F and E3HQ can be used in locations (3) and (6) above.

### Optical Fiber Photoelectric Sensors in Explosive Gas Atmospheres

The Fiber Unit can be installed in the hazardous area, and the Amplifier Unit can be installed in a non-hazardous area.

#### <Reason>

For explosion or fire due to electrical equipment to occur, both the hazardous atmosphere and a source of ignition must be in the same location. Optical energy does not act as an ignition source, thus there is no danger of explosion or fire. The lens, case, and fiber covering are made of plastic, so this setup cannot be used if there is a possibility of contact with solvents that will corrode or degrade (e.g., cloud) the plastic.

#### <Ignition Source>

Electrical sparks or high-temperature parts that have sufficient energy to cause explosion in a hazardous atmosphere are called ignition sources.

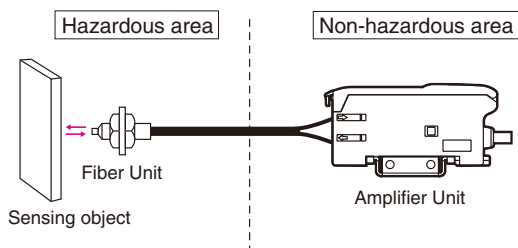

### Influence from External Electrical Fields

Do not bring a transceiver near the Photoelectric Sensor or its wiring, because this may cause incorrect operation.

## ● Maintenance and Inspection

### Points to Check When the Sensor Does Not Operate

- If the Sensor does not operate, check the following points.
  - (1) Are the wiring and connections correct?
  - (2) Are any of the mounting screws loose?
  - (3) Are the optical axis and sensitivity adjusted correctly?
  - (4) Do the sensing object and the workpiece speed satisfy the ratings and specifications?
  - (5) Are any foreign objects, such as debris or dust, adhering to the Emitter lens or Receiver lens?
  - (6) Is strong light, such as sunlight (e.g., reflected from a wall), shining on the Receiver?
  - (7) Do not attempt to disassemble or repair the Sensor under any circumstances.
  - (8) If you determine that the Sensor clearly has a failure, immediately turn OFF the power supply.

### Lens and Case

The lens and case of the Photoelectric Sensor are primarily made of plastic. Dirt should be gently wiped off with a dry cloth. Do not use thinner or other organic solvents.

- The case of the E3ZM, E3ZM-C and E3S-C is metal. The lens, however, is plastic.

## ● Accessories

### Using a Reflector (E39-R3/R37/RS1/RS2/RS3)

#### During Application

- (1) When using adhesive tape on the rear face, apply it after washing away oil and dust with detergent. The Reflector cannot be mounted if there is any oil or dirt remaining.
- (2) Do not press on the E39-RS1/RS2/RS3 with metal or a fingernail. This may weaken performance.
- (3) This Sensor cannot be used in locations where oil or chemicals may splash on the Sensor.

### M8 and M12 Connectors

- Be sure to connect or disconnect the connector after turning OFF the Sensor.
- Hold the connector cover to connect or disconnect the connector.
- Secure the connector cover by hand. Do not use pliers, otherwise the connector may be damaged.
- If the connector is not connected securely, the connector may be disconnected by vibration or the proper degree of protection of the Sensor may not be maintained.

## ● Others

### Values Given in Typical Examples

The data and values given as typical examples are not ratings and performance and do not indicate specified performance. They are rather values from samples taken from production lots, and are provided for reference as guidelines. Typical examples include the minimum sensing object, engineering data, step (height) detection data, and selection list for specifications.

### Cleaning

- Keep organic solvents away from the Sensor. Organic solvents will dissolve the surface.
- Use a soft, dry cloth to clean the Sensor.

## Read and Understand This Catalog

Please read and understand this catalog before purchasing the products. Please consult your OMRON representative if you have any questions or comments.

## Warranty and Limitations of Liability

### WARRANTY

OMRON's exclusive warranty is that the products are free from defects in materials and workmanship for a period of one year (or other period if specified) from date of sale by OMRON.

OMRON MAKES NO WARRANTY OR REPRESENTATION, EXPRESS OR IMPLIED, REGARDING NON-INFRINGEMENT, MERCHANTABILITY, OR FITNESS FOR PARTICULAR PURPOSE OF THE PRODUCTS. ANY BUYER OR USER ACKNOWLEDGES THAT THE BUYER OR USER ALONE HAS DETERMINED THAT THE PRODUCTS WILL SUITABLY MEET THE REQUIREMENTS OF THEIR INTENDED USE. OMRON DISCLAIMS ALL OTHER WARRANTIES, EXPRESS OR IMPLIED.

### LIMITATIONS OF LIABILITY

OMRON SHALL NOT BE RESPONSIBLE FOR SPECIAL, INDIRECT, OR CONSEQUENTIAL DAMAGES, LOSS OF PROFITS, OR COMMERCIAL LOSS IN ANY WAY CONNECTED WITH THE PRODUCTS, WHETHER SUCH CLAIM IS BASED ON CONTRACT, WARRANTY, NEGLIGENCE, OR STRICT LIABILITY.

In no event shall responsibility of OMRON for any act exceed the individual price of the product on which liability is asserted.

IN NO EVENT SHALL OMRON BE RESPONSIBLE FOR WARRANTY, REPAIR, OR OTHER CLAIMS REGARDING THE PRODUCTS UNLESS OMRON'S ANALYSIS CONFIRMS THAT THE PRODUCTS WERE PROPERLY HANDLED, STORED, INSTALLED, AND MAINTAINED AND NOT SUBJECT TO CONTAMINATION, ABUSE, MISUSE, OR INAPPROPRIATE MODIFICATION OR REPAIR.

## Application Considerations

### SUITABILITY FOR USE

OMRON shall not be responsible for conformity with any standards, codes, or regulations that apply to the combination of products in the customer's application or use of the product.

At the customer's request, OMRON will provide applicable third party certification documents identifying ratings and limitations of use that apply to the products. This information by itself is not sufficient for a complete determination of the suitability of the products in combination with the end product, machine, system, or other application or use.

The following are some examples of applications for which particular attention must be given. This is not intended to be an exhaustive list of all possible uses of the products, nor is it intended to imply that the uses listed may be suitable for the products:

- Outdoor use, uses involving potential chemical contamination or electrical interference, or conditions or uses not described in this catalog.
- Nuclear energy control systems, combustion systems, railroad systems, aviation systems, medical equipment, amusement machines, vehicles, safety equipment, and installations subject to separate industry or government regulations.
- Systems, machines, and equipment that could present a risk to life or property.

Please know and observe all prohibitions of use applicable to the products.

NEVER USE THE PRODUCTS FOR AN APPLICATION INVOLVING SERIOUS RISK TO LIFE OR PROPERTY WITHOUT ENSURING THAT THE SYSTEM AS A WHOLE HAS BEEN DESIGNED TO ADDRESS THE RISKS, AND THAT THE OMRON PRODUCT IS PROPERLY RATED AND INSTALLED FOR THE INTENDED USE WITHIN THE OVERALL EQUIPMENT OR SYSTEM.

## Disclaimers

### CHANGE IN SPECIFICATIONS

Product specifications and accessories may be changed at any time based on improvements and other reasons.

It is our practice to change model numbers when published ratings or features are changed, or when significant construction changes are made. However, some specifications of the product may be changed without any notice. When in doubt, special model numbers may be assigned to fix or establish key specifications for your application on your request. Please consult with your OMRON representative at any time to confirm actual specifications of purchased product.

### DIMENSIONS AND WEIGHTS

Dimensions and weights are nominal and are not to be used for manufacturing purposes, even when tolerances are shown.

### ERRORS AND OMISSIONS

The information in this catalog has been carefully checked and is believed to be accurate; however, no responsibility is assumed for clerical, typographical, or proofreading errors, or omissions.

### PERFORMANCE DATA

Performance data given in this catalog is provided as a guide for the user in determining suitability and does not constitute a warranty. It may represent the result of OMRON's test conditions, and the users must correlate it to actual application requirements. Actual performance is subject to the OMRON Warranty and Limitations of Liability.

### PROGRAMMABLE PRODUCTS

OMRON shall not be responsible for the user's programming of a programmable product, or any consequence thereof.

### COPYRIGHT AND COPY PERMISSION

This catalog shall not be copied for sales or promotions without permission.

This catalog is protected by copyright and is intended solely for use in conjunction with the product. Please notify us before copying or reproducing this catalog in any manner, for any other purpose. If copying or transmitting this catalog to another, please copy or transmit it in its entirety.