

# Bench Top Blower Ionizer Installation, Operation and Maintenance



Made in the  
United States of America



Figure 1. Desco Bench Top Blower Ionizer

## Description

This ionizing unit is a self-balancing bench top ionizer. The ionizer's Faraday Balance System assures low offset voltage or balance automatically. It offers greater efficiency and easier cleaning than conventional ionizers. The Bench Top Ionizer is designed to neutralize static electricity from insulators and isolated conductors in localized work areas in assembly rooms, wave solder lines, laboratories, QC, test stations, packing and shipping areas and clean rooms.

Ionizers are useful in limiting electrostatic charge generation, ElectroStatic Discharge, and ElectroStatic Attraction, as well as preventing equipment latch-up. ANSI/ESD S20.20 Paragraph 6.2.3.1 Protected Areas Requirement states: "Ionization or other charge mitigating techniques shall be used at the workstation to neutralize electrostatic fields on all process essential insulators if the electrostatic field is considered a threat." Some examples of process necessary insulators are: the PC board itself, plastic test stands, plastic housing where a PCB may be mounted, as well as computer monitor screens and regular cleaning wipes. Examples of floating or isolated conductors are: loaded PCB mounted in a stand where the pins are not contacting the dissipative workstation. Ionization is not effective on items that have large capacitance, like people and carts; however, ionizers should be considered as a method for charge neutralization in cases where grounding cannot be achieved.

Air ionization can neutralize the static charge on insulated and isolated objects by producing separate charges in the molecules of the gases of the surrounding air. When an electrostatic charge is present on objects in the work environment, it will be neutralized by attracting opposite polarity charges from the ionized air. Note that ionization systems should not be used as a primary means of charge control on conductors or people. (Reference: IEC 61340-5-2:1 paragraph 5.2.9).

## Ionizer Selection

ANSI/ESD S20.20 section 6.1.1.2. ESD Control Program Plan Guidance states: "The Plan should include a listing of the specific type of ESD protective materials and equipment used in the Program." When selecting an ionizer, life cycle costs should be considered, including:

- equipment cost
- installation cost
- operation and maintenance cost

The Desco Bench Top Blower Ionizer is available in the following models:

Item	Input Voltage	Power Cord
<a href="#">19500</a>	120VAC	North America
<a href="#">19520</a>	220VAC	Not Included

## Packaging

- 1 Bench Top Blower Ionizer
- 1 Power Cord, 6' (19500 only)
- 1 Filter and Guard Assembly
- 1 Certificate of Calibration

## Installation

The unit is normally mounted at one end of a workbench or area to be neutralized. It may also be mounted to a wall or shelf. The ionizer's neutralization (discharge) times will be best from approximately 6" to 42" in front of the unit and will drop off as the distance from the unit increases.

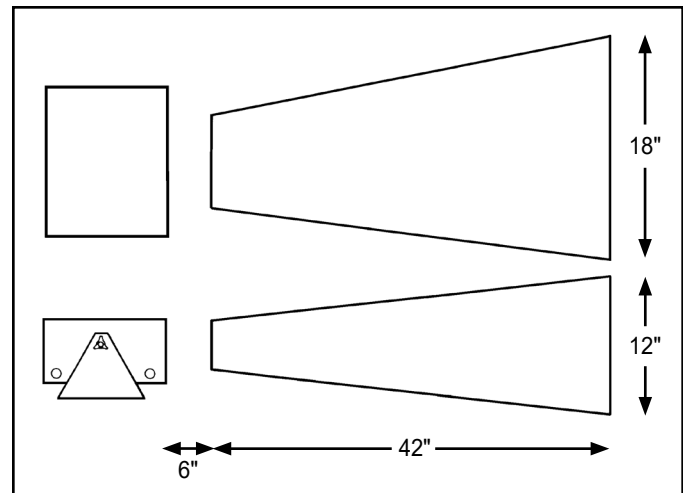

Figure 2. Area of optimum charge neutralization

Mount the unit in the desired position. You can bolt the stand to a wall or under a shelf as desired. For best results, the unit should be mounted so that no obstructions exist between the output area and the area to be neutralized.

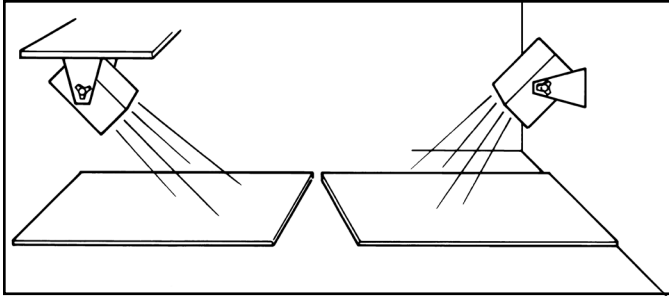

Figure 3. Wall or shelf mounting of the ionizer

Set both front panel rocker switches in the “off” position.

Connect the IEC plug into the connector on the back panel of the ionizer, press firmly to ensure that the cord is properly attached. Install the power cord into a properly grounded outlet. The ionizer must be grounded for proper operation. Desco recommends the [19219](#) Ground Hub Continuous Monitor or [98132](#) AC Outlet Analyzer to check the ground.

## Operation

Turn on the power switch and adjust fan speed for the desired air flow. Higher air flow will result in a faster neutralization rate.

Aim the unit so that the maximum airflow is directed at the items or area to be neutralized.

The left rocker switch turns on a heater which will raise the temperature of the output air to about 10°F above ambient. The heater is only to offset the chill factor of the moving air. It is not intended to warm the workstation.

If the ionizer is used in a manner not specified by the manufacturer, the protection provided by the ionizer may be impaired.

## Maintenance

“As with all ionizers, periodic maintenance will be needed to provide optimum performance.” (Reference: IEC 61340-5-2:1 paragraph 5.2.9).

The frequency of monitoring ionizers really depends on how and where they are used. Since the majority of them use a fan to transport the ions to the working area, the cleanliness of the air directly affects their performance over time and how often the emitters should be cleaned.

EIA-625 recommends checking ionizers every 6 months, but this may not be suitable for many programs particularly since an out-of-balance may exist for months before it is checked again. ANSI/ESD S20.20 section 6.1.3.1 Compliance Verification Plan Requirement states: “Test equipment shall be selected to make measurements of appropriate properties of the technical requirements that are incorporated into the ESD program plan.” And section 6.1.3.2. Compliance Verification Plan Guidance states: “In addition to internal audits, external audits (Organization and supplier of ESDS items) should be performed to ensure compliance with planned requirements. Verifications should include routine checks of the Technical Requirements in the Plan. The frequency of verification checks should be based on the control item usage, its durability and associated risk of failure.”

Under normal conditions, the ionizer will attract and accumulate dirt and dust (especially on the emitter electrodes). To maintain optimum performance, cleaning must be performed on a regular basis. The electrodes should be cleaned at least as often as indicated in the next section. However, more frequent cleaning may be required if used in environments with more contaminants.

### METHOD 1 (Annually)

To remove heavier accumulations of dirt and dust, use clean, compressed air. **Disconnect power to the ionizer.** With one hand firmly on top of the ionizer, aim compressed air through the front grill, directly at the pins. A few passes back and forth with the nozzle is sufficient.

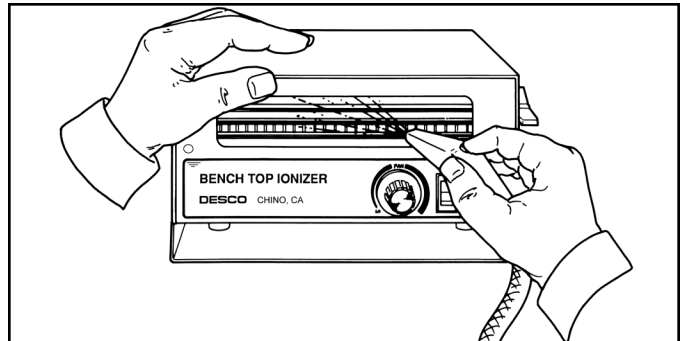

Figure 4. Cleaning the electrodes using compressed air

## METHOD 2 (As needed in harsh environments)

This cleaning method will remove all contaminants. Since this method requires direct contact with emitter electrodes, it is critical that the ionizer be unplugged before beginning this cleaning process. **Disconnect power to the ionizer.** Dampen the end of a non-linting cotton swab with isopropyl alcohol. **Alcohol is flammable. Extreme caution should be used when handling any flammable solvent.** Reaching carefully through the grill bars, gently wipe each electrode until clean. Avoid bending any electrodes. If any electrodes become dislodged, nudge them with the tail end of the cleaning brush until they remain no less than 1/4" from any object. **Wait 15 minutes for alcohol to evaporate before plugging in the ionizer.**

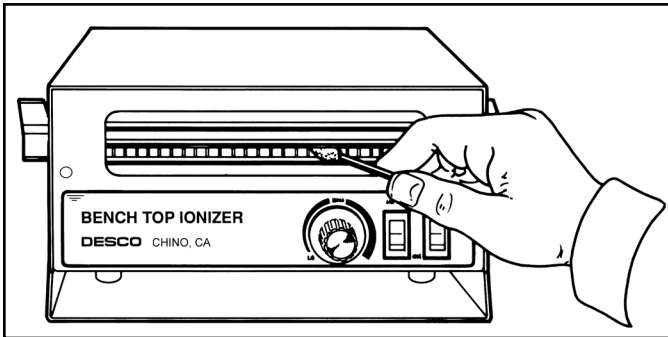

Figure 5. Cleaning the electrodes using a cotton swab dampened with isopropyl alcohol

## ADJUSTMENT

There are no user adjustable or serviceable parts inside the ionizer. Adjusting or dismantling your ionizer may create dangerous conditions and unauthorized modifications will void the product warranty. Servicing should be performed only at the factory, or by a technician trained in high voltage circuits. See warranty section for repair information.

## THEORY OF OPERATION

The Bench Top Blower Ionizer employs a safe non-nuclear AC ionization source. AC systems utilize emitter electrodes that are switched rapidly between positive and negative high voltage, usually at the power line frequency (50/60 Hz). The ionizer's unique Faraday Balance System monitors ion output and automatically adjusts the unit to reach an equilibrium at low offset voltage or balanced ion flow. The ionizer is designed to achieve balance under extreme conditions and is uniquely able to maintain balance in most any environment.

Ions are emitted in an efficient laminar flow. This reduces air turbulence and ion recombination, prolongs cleanliness and increases efficiency. The ionizer's unique tri-metallic ion emitter electrodes produce a high ion output for rapid charge dissipation.

The Bench Top Blower Ionizer is engineered for efficiency and durability, making this bench top ionizer highly dependable and cost effective.

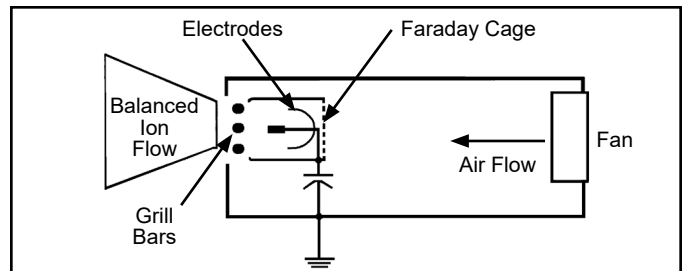

Figure 6. Components of the Faraday Balance System

## Neutralization (Discharge) Times

All data was taken with the fan speed set to high. All time measurements are in seconds.

NOTE: Discharge times in seconds are representative only and are not a guarantee. Discharge times are actual measurements recorded in a factory ambient environment.

Per ANSI/ESD S20.20, the test method for Product Qualification test is ANSI/ESD STM3.1, and for Compliance Verification is ESD TR53 which advises "Measurements should be made at the location where ESD sensitive items are to be ionized." A larger area may require additional ionizers. Per S20.20 the required limit for ionizer discharge time is user defined. Use Table to determine the number of ionizers to achieve ionization of area to be neutralized to meet your company's ESD control plan specified discharge times.

The comparative efficiency of bench top ionizers is determined by a standard test published by the ESD Association: ANSI/ESD STM 3.1. Typical positive and negative decay times (1000V - 100V) measured using this standard are shown in the figures below. The performance of the ionizer was measured with the unit positioned as shown, with the fan speed on high and without a filter.

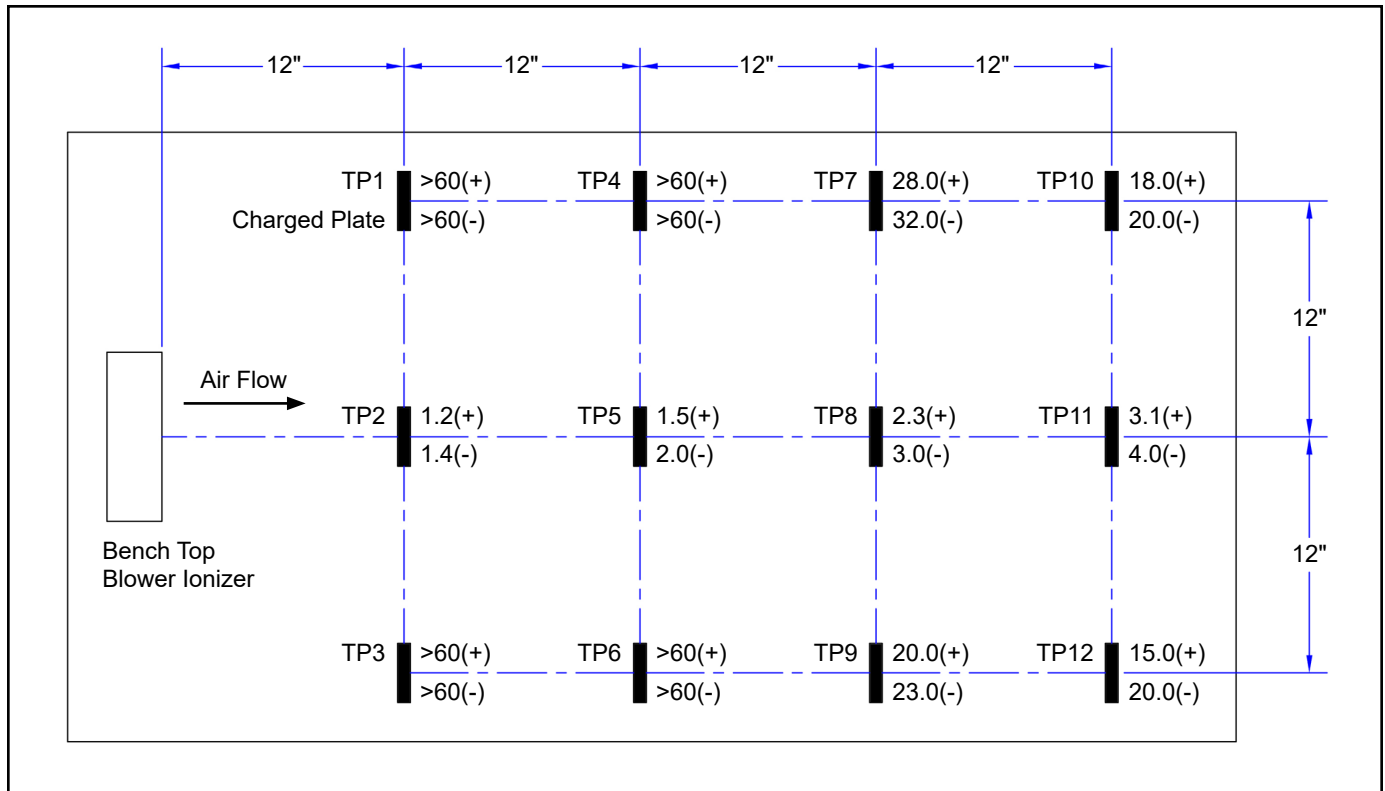

Figure 7. Neutralization (Discharge) Times of item [19500](#) at 120VAC, 60Hz input

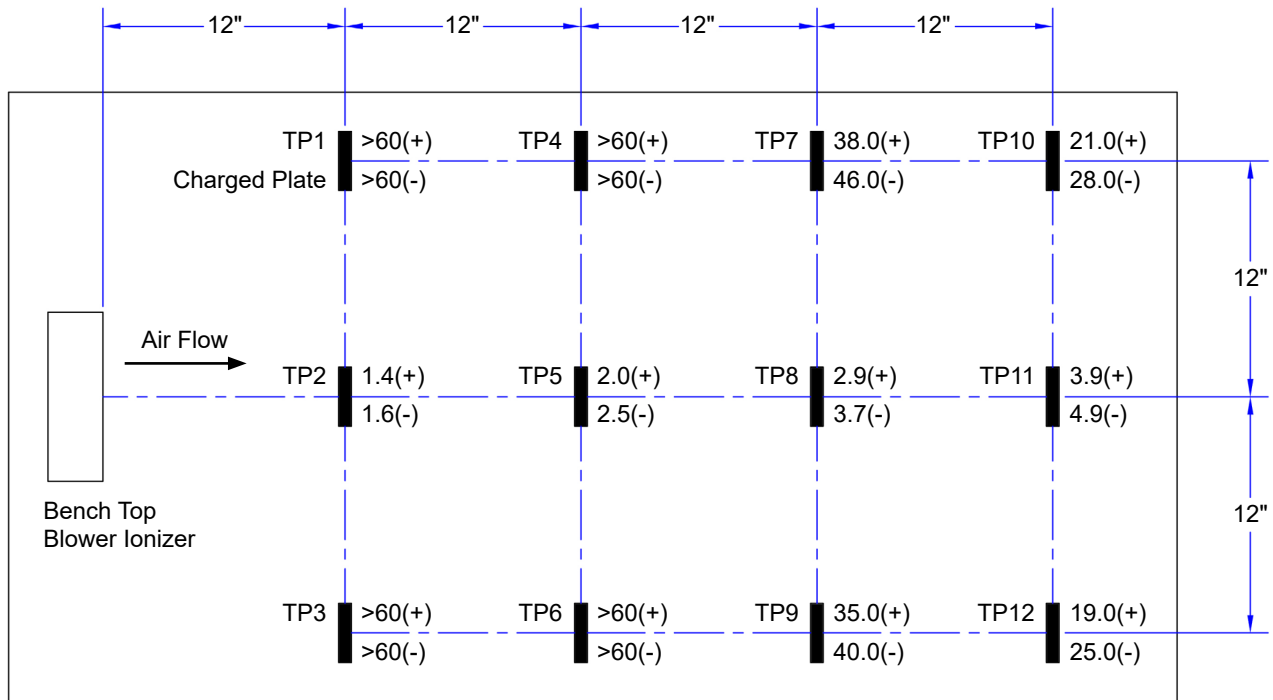

Figure 8. Neutralization (Discharge) Times of item [19500](#) at 100VAC, 50Hz input

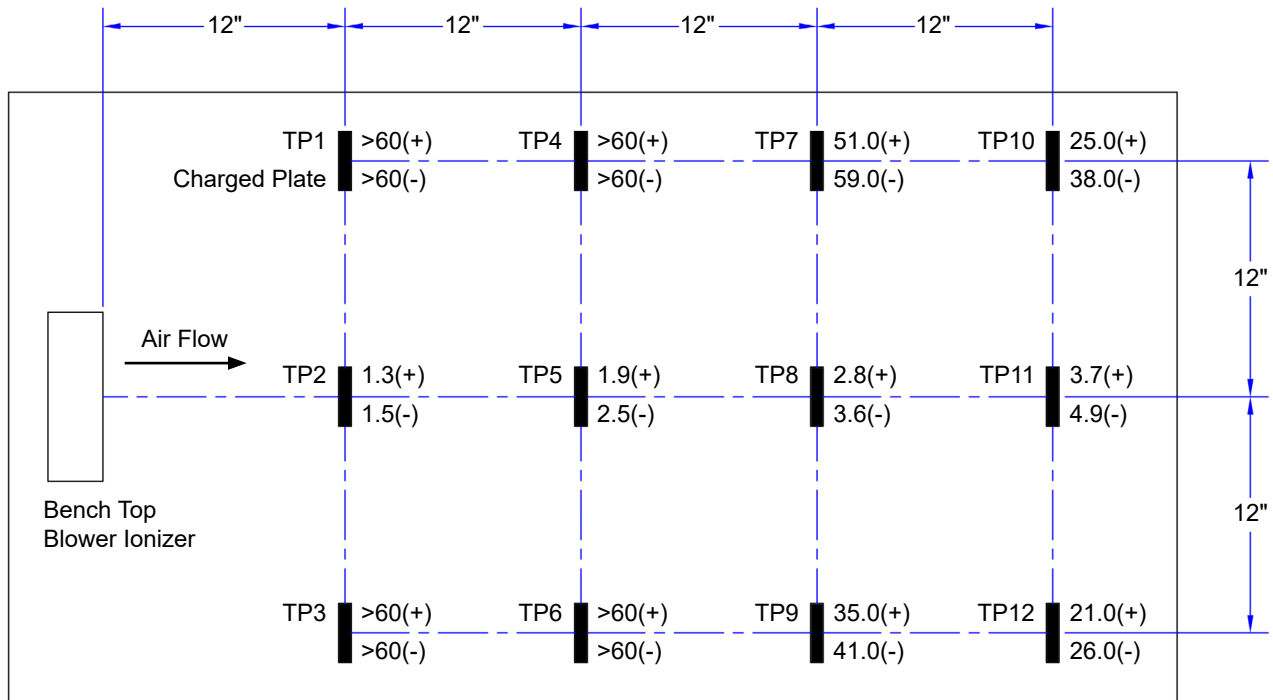

Figure 9. Neutralization (Discharge) Times of item [19520](#) at 230VAC, 50Hz input

## Specifications

Input:  
[19500](#) 120 VAC - 50/60 Hz - 3.0 Amps  
[19520](#) 220 VAC - 50/60 Hz - 1.5 Amps

Fuse Type:  
[19500](#) Slow blow 5 amp  
[19520](#) Slow blow 3 amp

Output: 4.5kV at 50 - 60 nano amps

Air Flow: Adjustable 117 CFM maximum

Balance Voltage\*:  $\pm 5V$

Dimensions: 11" x 9" x 7"

Weight:  
[19500](#) 13 Pounds  
[19520](#) 16 Pounds

Cord:  
[19500](#) Cord with three wire IEC plug  
(ground required)  
[19520](#) Not included

\*Desco ionizers meet the ANSI/ESD S20.20 minimum recommended technical requirement range of less than  $\pm 35V$  voltage offset tested in accordance with ANSI/ESD STM3.1. Desco models [19500](#) and [19520](#) outperform the requirement providing  $\pm 5$  Volt auto-balancing.

### Limited Warranty, Warranty Exclusions, Limit of Liability and RMA Request Instructions

See the Desco Terms and Conditions -  
<http://desco.descoindustries.com/TermsAndConditions.aspx>