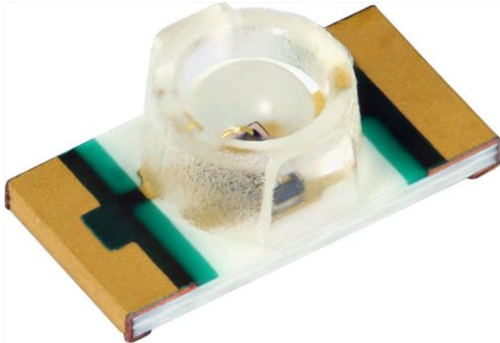


High Speed Infrared Emitting Diodes, 850 nm, Surface Emitter Technology



DESCRIPTION

As part of the [SurfLight™](#) portfolio, the VSMY12850 is an infrared, 850 nm, top looking emitting diode based on GaAlAs surface emitter chip technology with extreme high radiant intensities, high optical power and high speed, molded in clear, untinted PCB based package (with inner lens) for surface mounting (SMD).

APPLICATIONS

- Emitter for proximity applications
- IR touch panels
- Photointerrupters
- Optical switch

FEATURES

- Package type: surface mount
- Package form: top view
- Dimensions (L x W x H in mm): 3.2 x 1.6 x 1.1
- Peak wavelength: $\lambda_p = 850$ nm
- High reliability
- High radiant power
- Very high radiant intensity
- Angle of half intensity: $\phi = \pm 40^\circ$
- Suitable for high pulse current operation
- Floor life: 168 h, MSL 3, according to J-STD-020
- Material categorization: for definitions of compliance please see www.vishay.com/doc?99912



PRODUCT SUMMARY				
COMPONENT	I_e (mW/sr)	ϕ (deg)	λ_p (nm)	t_r (ns)
VSMY12850	16	± 40	850	10

Note

- Test conditions see table “Basic Characteristics“

ORDERING INFORMATION			
ORDERING CODE	PACKAGING	REMARKS	PACKAGE FORM
VSMY12850	Tape and reel	MOQ: 3000 pcs, 3000 pcs/reel	Top view

Note

- MOQ: minimum order quantity

ABSOLUTE MAXIMUM RATINGS ($T_{amb} = 25^\circ\text{C}$, unless otherwise specified)				
PARAMETER	TEST CONDITION	SYMBOL	VALUE	UNIT
Reverse voltage		V_R	5	V
Forward current		I_F	70	mA
Surge forward current	$t_p = 100 \mu\text{s}$	I_{FSM}	1	A
Power dissipation		P_V	140	mW
Junction temperature		T_j	100	$^\circ\text{C}$
Operating temperature range		T_{amb}	-40 to +85	$^\circ\text{C}$
Storage temperature range		T_{stg}	-40 to +100	$^\circ\text{C}$
Soldering temperature	acc. figure 10, J-STD-020	T_{sd}	260	$^\circ\text{C}$
Thermal resistance junction/ambient	J-STD-051, soldered on PCB	R_{thJA}	390	K/W

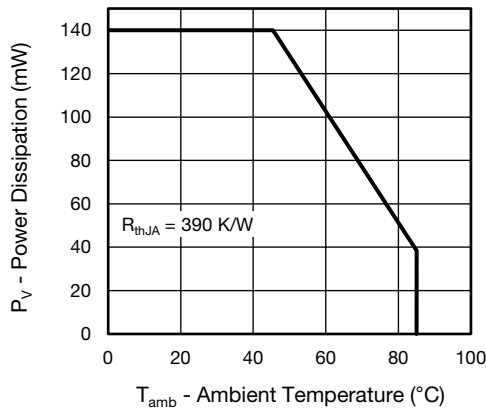


Fig. 1 - Power Dissipation Limit vs. Ambient Temperature

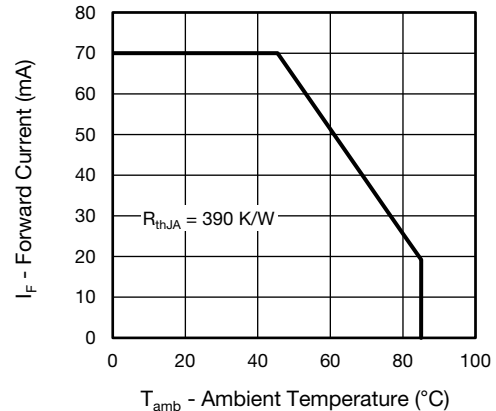


Fig. 2 - Forward Current Limit vs. Ambient Temperature

BASIC CHARACTERISTICS ($T_{amb} = 25\text{ }^{\circ}\text{C}$, unless otherwise specified)						
PARAMETER	TEST CONDITION	SYMBOL	MIN.	TYP.	MAX.	UNIT
Forward voltage	$I_F = 20\text{ mA}$, $t_p = 20\text{ ms}$	V_F	1.1	1.4	1.9	V
	$I_F = 70\text{ mA}$, $t_p = 20\text{ ms}$	V_F		1.65		V
	$I_F = 1\text{ A}$, $t_p = 100\text{ }\mu\text{s}$	V_F		2.9		V
Temperature coefficient of V_F	$I_F = 20\text{ mA}$	TK_{V_F}		-1.7		mV/K
Reverse current		I_R	not designed for reverse operation			μA
Junction capacitance	$V_R = 0\text{ V}$, $f = 1\text{ MHz}$, $E = 0\text{ mW/cm}^2$	C_J		5		pF
Radiant intensity	$I_F = 20\text{ mA}$, $t_p = 20\text{ ms}$	I_e	2.3	4.7		mW/sr
	$I_F = 70\text{ mA}$, $t_p = 20\text{ ms}$	I_e		16		mW/sr
	$I_F = 1\text{ A}$, $t_p = 100\text{ }\mu\text{s}$	I_e		130		mW/sr
Radiant power	$I_F = 70\text{ mA}$, $t_p = 20\text{ ms}$	ϕ_e		40		mW
Temperature coefficient of radiant power	$I_F = 20\text{ mA}$	TK_{ϕ_e}		-0.19		%/K
Angle of half intensity		ϕ		± 40		deg
Peak wavelength	$I_F = 20\text{ mA}$	λ_p	830	850	870	nm
Spectral bandwidth	$I_F = 20\text{ mA}$	$\Delta\lambda$		35		nm
Temperature coefficient of λ_p	$I_F = 20\text{ mA}$	TK_{λ_p}		0.25		nm/K
Rise time	$I_F = 100\text{ mA}$, 20 % to 80 %	t_r		10		ns
Fall time	$I_F = 100\text{ mA}$, 20 % to 80 %	t_f		10		ns

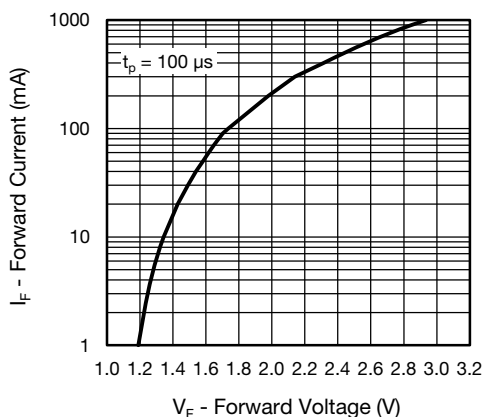
BASIC CHARACTERISTICS ($T_{amb} = 25\text{ }^{\circ}\text{C}$, unless otherwise specified)


Fig. 3 - Forward Current vs. Forward Voltage

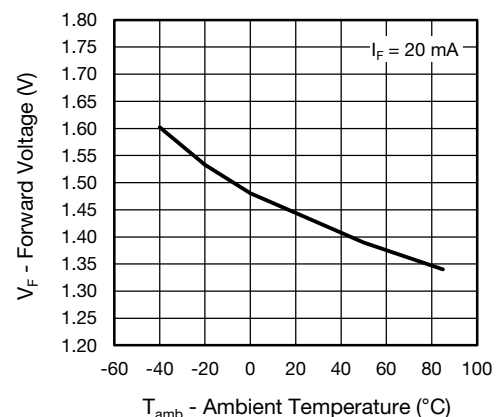


Fig. 4 - Forward Voltage vs. Ambient Temperature

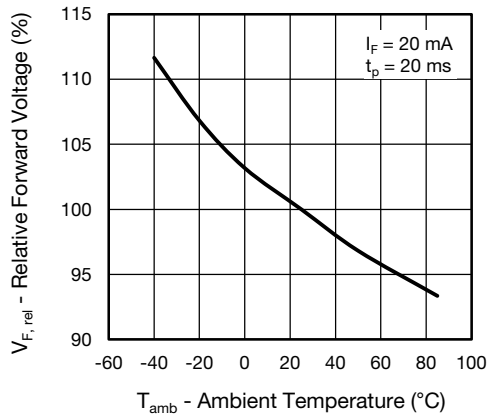


Fig. 5 - Relative Forward Voltage vs. Ambient Temperature

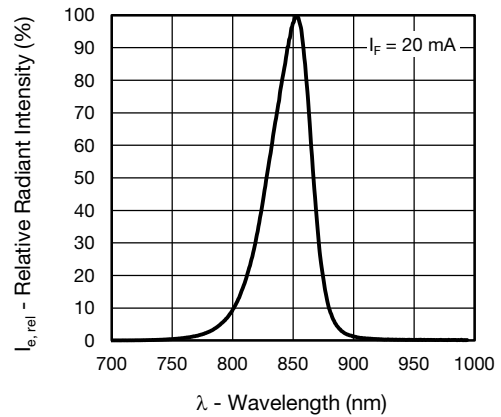


Fig. 8 - Relative Radiant Intensity vs. Wavelength

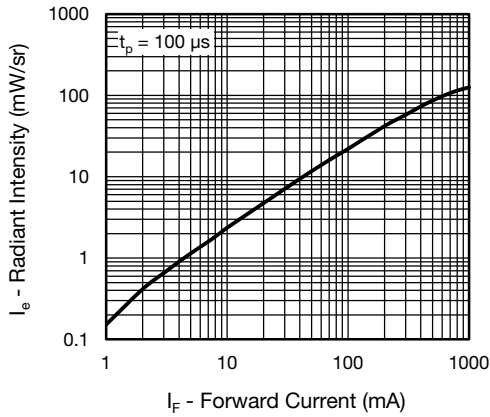


Fig. 6 - Radiant Intensity vs. Forward Current

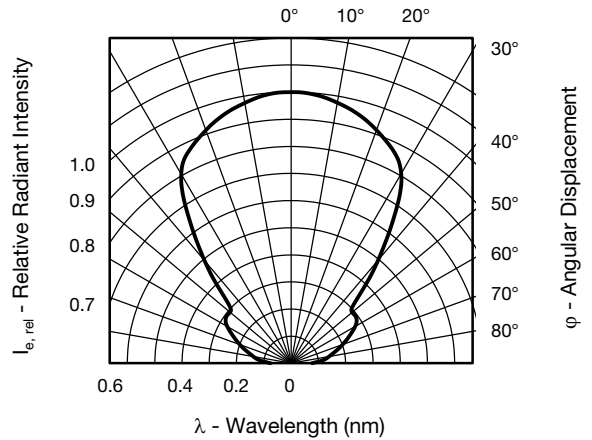


Fig. 9 - Relative Radiant Intensity vs. Angular Displacement

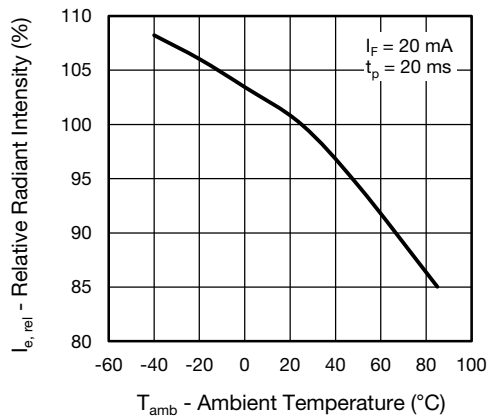


Fig. 7 - Relative Radiant Intensity vs. Ambient Temperature

SOLDER PROFILE

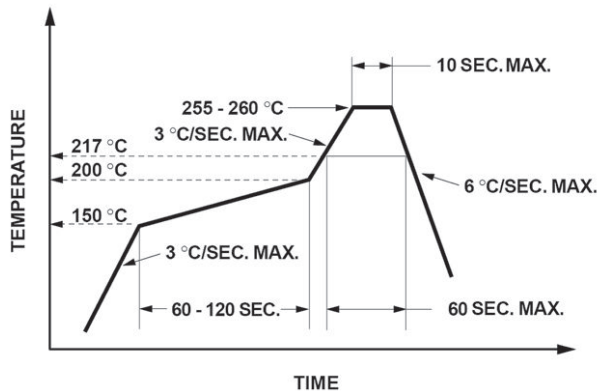


Fig. 10 - Lead (Pb)-free Reflow Solder Profile acc. J-STD-020

DRYPACK

Devices are packed in moisture barrier bags (MBB) to prevent the products from moisture absorption during transportation and storage. Each bag contains a desiccant.

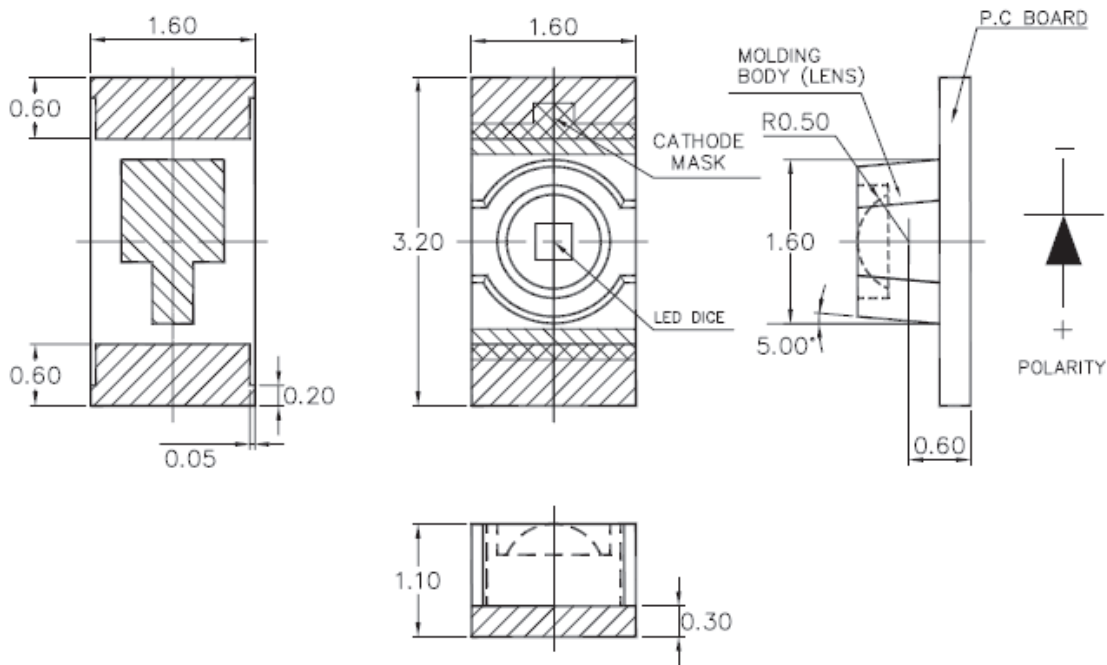
FLOOR LIFE

Floor life (time between soldering and removing from MBB) must not exceed the time indicated on MBB label:
 Floor life: 168 h
 Conditions: $T_{amb} < 30\text{ °C}$, $RH < 60\%$
 Moisture sensitivity level 3, according to J-STD-020.

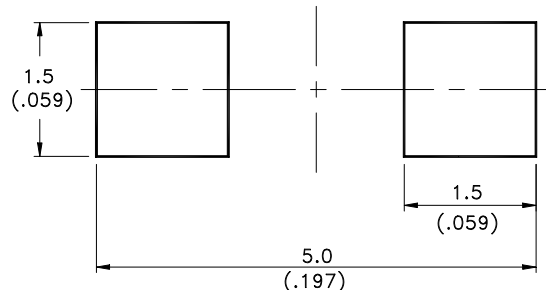
DRYING

In case of moisture absorption devices should be baked before soldering. Conditions see J-STD-020 or label.
 Devices taped on reel dry using recommended conditions
 192 h at 40 °C (+ 5 °C), $RH < 5\%$.

PACKAGE DIMENSIONS in millimeters: **VSMY12850**

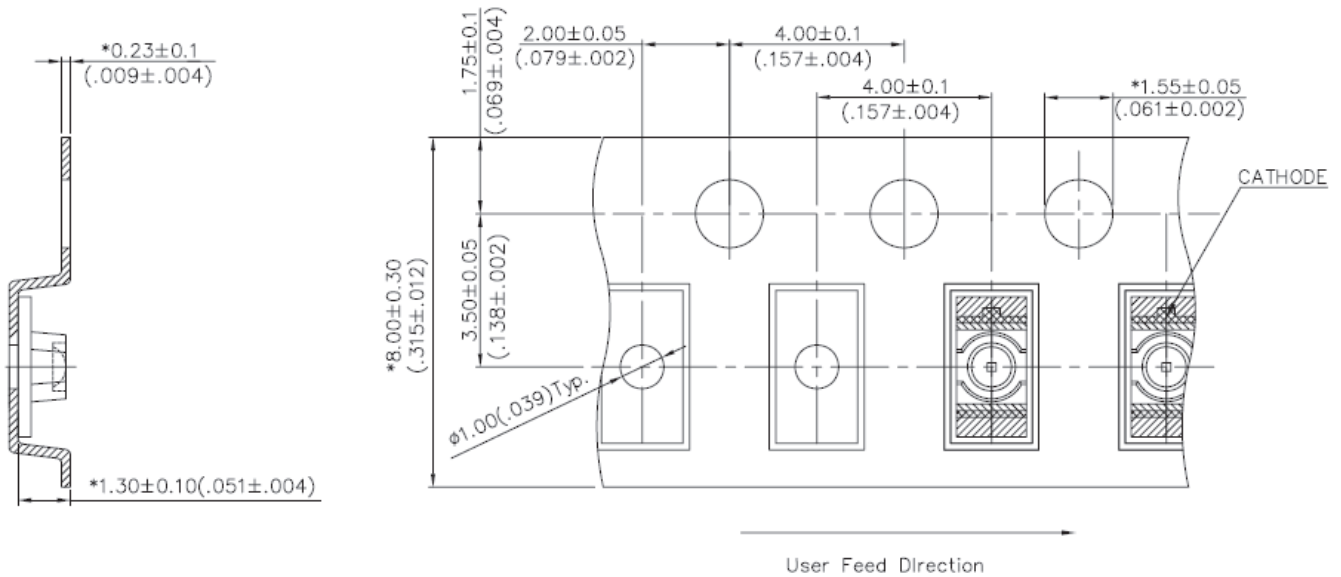
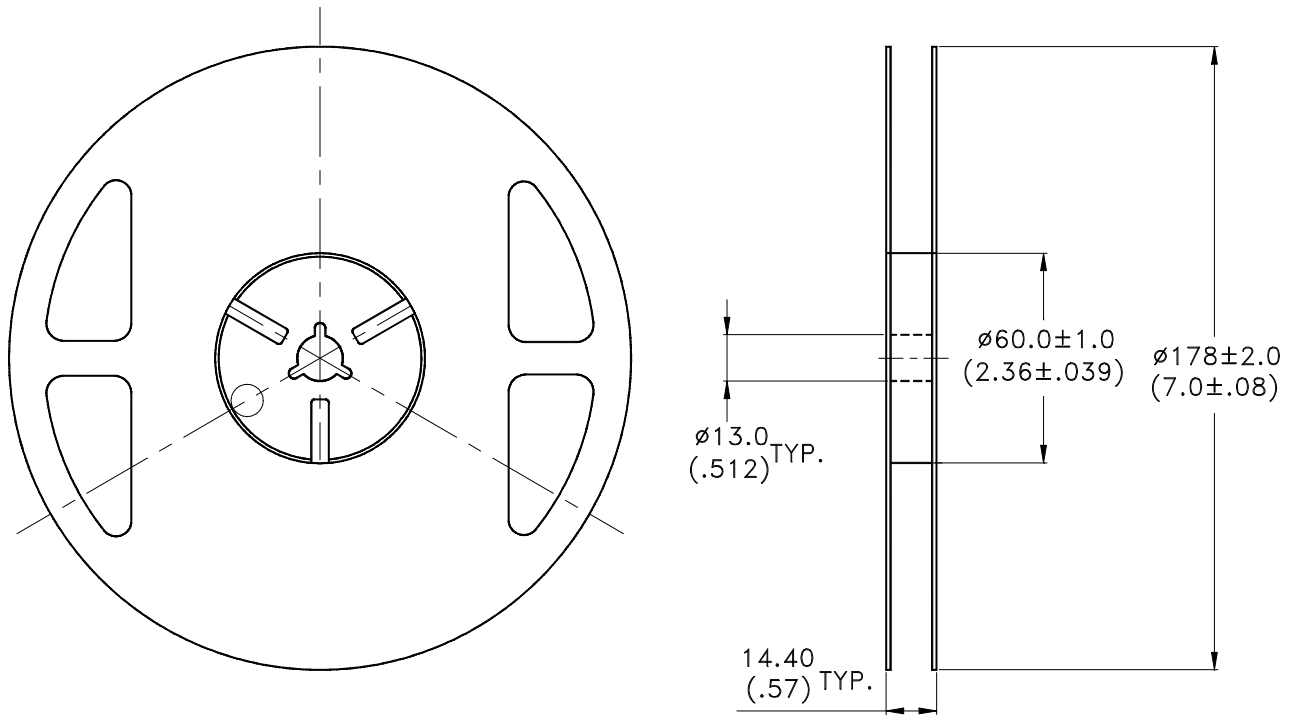


Recommended Solder Pad





TAPING AND REEL DIMENSIONS in millimeters: VSMY12850





Disclaimer

ALL PRODUCT, PRODUCT SPECIFICATIONS AND DATA ARE SUBJECT TO CHANGE WITHOUT NOTICE TO IMPROVE RELIABILITY, FUNCTION OR DESIGN OR OTHERWISE.

Vishay Intertechnology, Inc., its affiliates, agents, and employees, and all persons acting on its or their behalf (collectively, "Vishay"), disclaim any and all liability for any errors, inaccuracies or incompleteness contained in any datasheet or in any other disclosure relating to any product.

Vishay makes no warranty, representation or guarantee regarding the suitability of the products for any particular purpose or the continuing production of any product. To the maximum extent permitted by applicable law, Vishay disclaims (i) any and all liability arising out of the application or use of any product, (ii) any and all liability, including without limitation special, consequential or incidental damages, and (iii) any and all implied warranties, including warranties of fitness for particular purpose, non-infringement and merchantability.

Statements regarding the suitability of products for certain types of applications are based on Vishay's knowledge of typical requirements that are often placed on Vishay products in generic applications. Such statements are not binding statements about the suitability of products for a particular application. It is the customer's responsibility to validate that a particular product with the properties described in the product specification is suitable for use in a particular application. Parameters provided in datasheets and/or specifications may vary in different applications and performance may vary over time. All operating parameters, including typical parameters, must be validated for each customer application by the customer's technical experts. Product specifications do not expand or otherwise modify Vishay's terms and conditions of purchase, including but not limited to the warranty expressed therein.

Except as expressly indicated in writing, Vishay products are not designed for use in medical, life-saving, or life-sustaining applications or for any other application in which the failure of the Vishay product could result in personal injury or death. Customers using or selling Vishay products not expressly indicated for use in such applications do so at their own risk. Please contact authorized Vishay personnel to obtain written terms and conditions regarding products designed for such applications.

No license, express or implied, by estoppel or otherwise, to any intellectual property rights is granted by this document or by any conduct of Vishay. Product names and markings noted herein may be trademarks of their respective owners.

Material Category Policy

Vishay Intertechnology, Inc. hereby certifies that all its products that are identified as RoHS-Compliant fulfill the definitions and restrictions defined under Directive 2011/65/EU of The European Parliament and of the Council of June 8, 2011 on the restriction of the use of certain hazardous substances in electrical and electronic equipment (EEE) - recast, unless otherwise specified as non-compliant.

Please note that some Vishay documentation may still make reference to RoHS Directive 2002/95/EC. We confirm that all the products identified as being compliant to Directive 2002/95/EC conform to Directive 2011/65/EU.

Vishay Intertechnology, Inc. hereby certifies that all its products that are identified as Halogen-Free follow Halogen-Free requirements as per JEDEC JS709A standards. Please note that some Vishay documentation may still make reference to the IEC 61249-2-21 definition. We confirm that all the products identified as being compliant to IEC 61249-2-21 conform to JEDEC JS709A standards.