

THIS DRAWING IS UNPUBLISHED. RELEASED FOR PUBLICATION  
 © COPYRIGHT - By - ALL RIGHTS RESERVED.

REVISIONS				
P	LTR	DESCRIPTION	DATE	APVD
F		REVISED PER ECO-17-000623	28JUL2017	SY SY

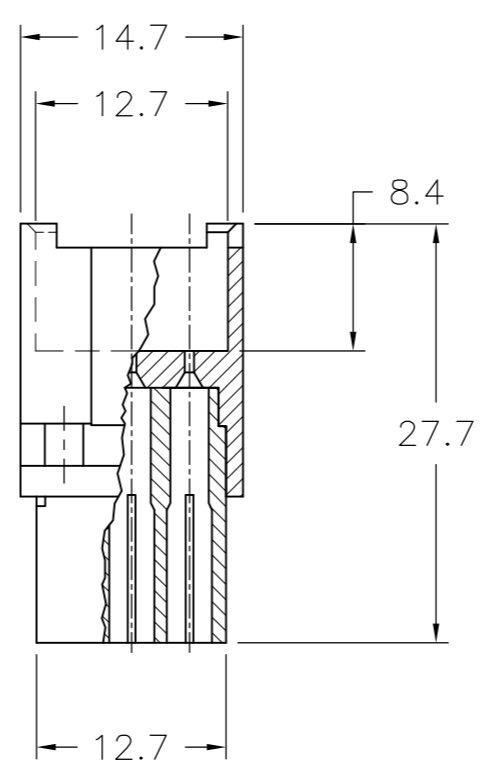

- 1 MATERIAL: 20% GLASS FILLED NORYL, COLOR: GREY RAL 7032.
- 2 BLOCK MARKING AND CAVITY NUMBERS PRINTED IN GREEN COLOR.

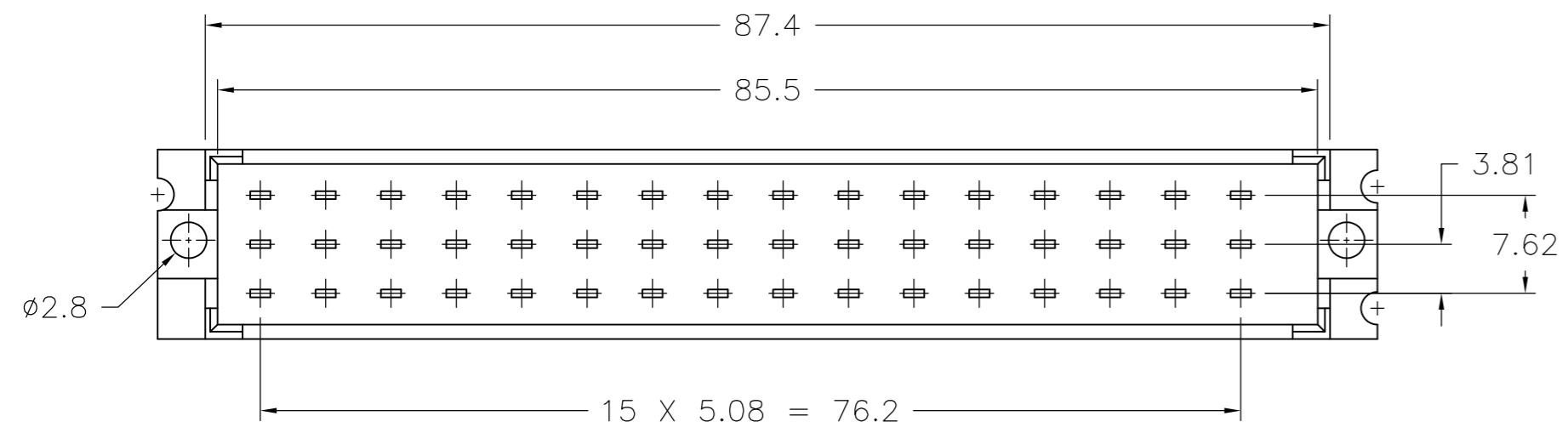
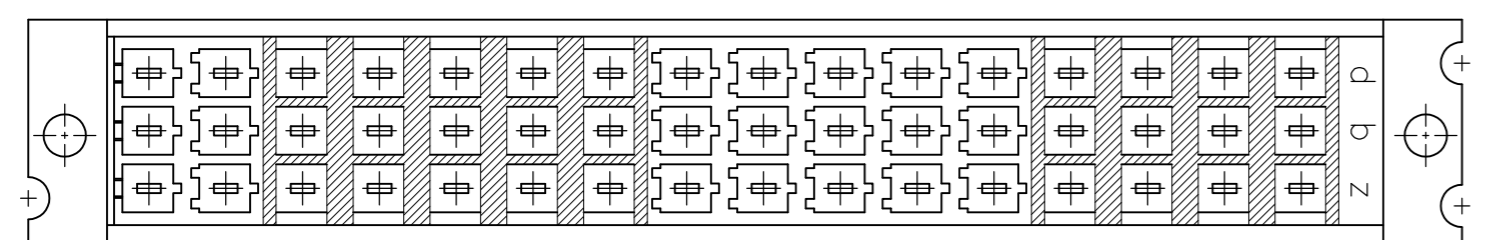
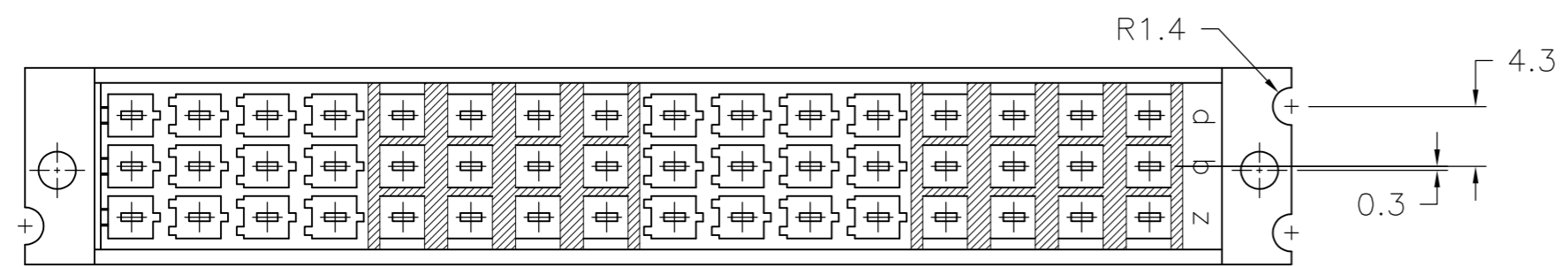
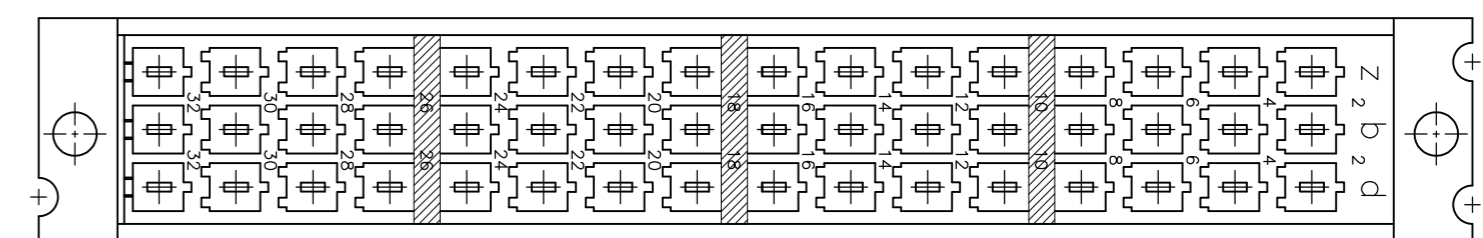
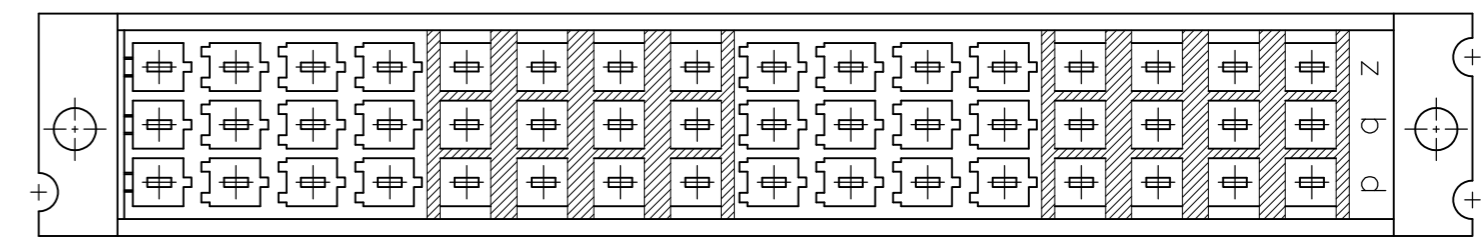
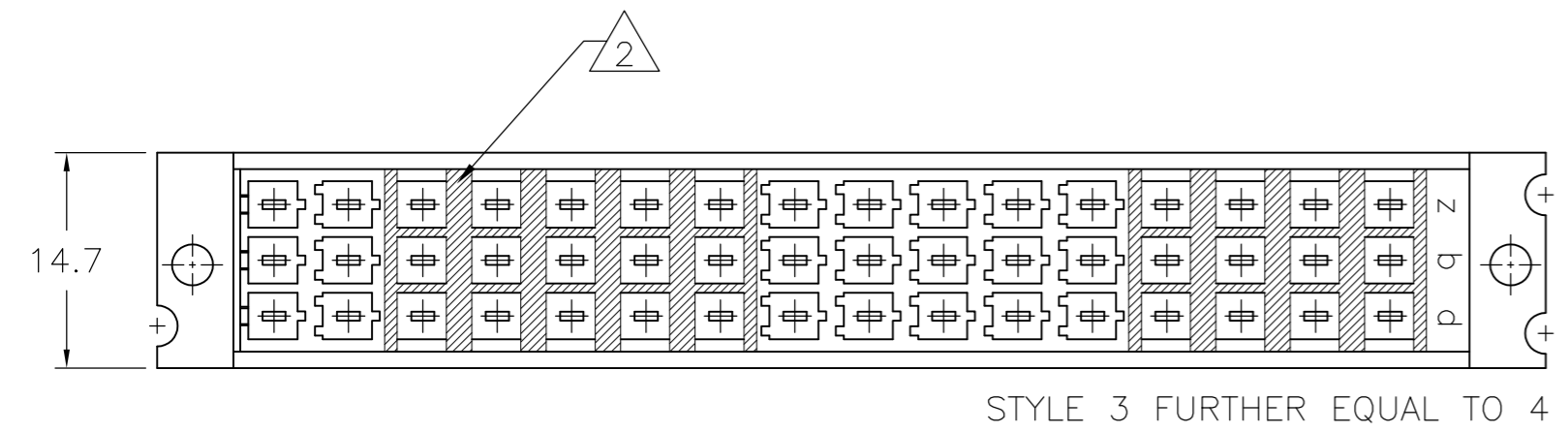
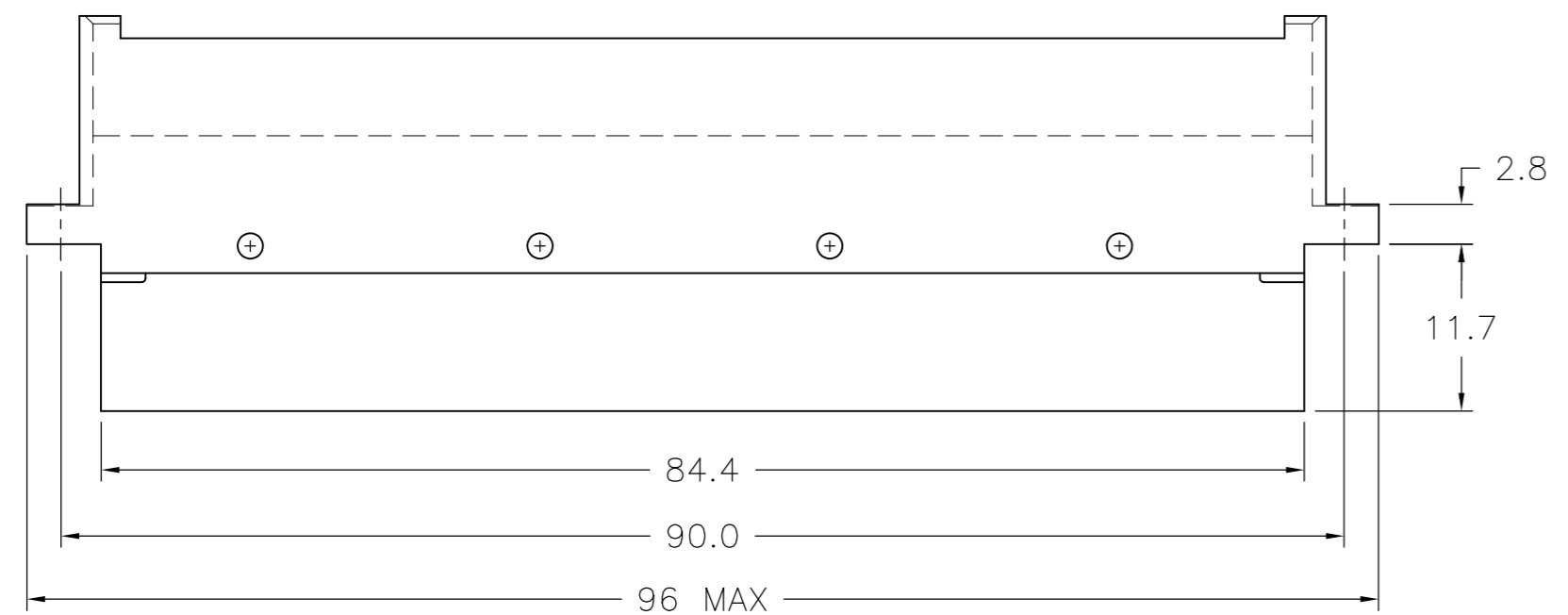

	5	1-166570-0
OBSOLETE	4	166570-9
OBSOLETE	3	166570-8
OBSOLETE	1	166570-7
OBSOLETE	2	166570-1
	STYLE	PART NUMBER

THIS DRAWING IS A CONTROLLED DOCUMENT.		DWN B.CARBO 16JAN2013	<b>TE</b> TE Connectivity	
DIMENSIONS: mm		CHK R.PATTERSON 16JAN2013		
TOLERANCES UNLESS OTHERWISE SPECIFIED:		APVD R.PATTERSON 16JAN2013	NAME	
0 PLC ± -		PRODUCT SPEC	48 POS, MALE CONN ASSY, FOR COSI CONTACTS, ACC. DIN 41612	
1 PLC ± -		APPLICATION SPEC	-	
2 PLC ± .02		WEIGHT 0.000000	SIZE A2	CAGE CODE 00779
3 PLC ± .005		FINISH -	DRAWING NO C=166570	
4 PLC ± .0005		MATERIAL 1	SCALE 2:1	SHEET 1 OF 1
ANGLES ± -		CUSTOMER DRAWING	REV F	