

## HB-2X2-RS

~10° spot beam

### TECHNICAL SPECIFICATIONS:

Dimensions	50.0 mm
Height	10 mm
Fastening	screw
ROHS compliant	yes 

### MATERIAL SPECIFICATIONS:

Component	Type	Material	Colour	Finish
HB-2X2-RS	Multi-lens	PMMA	clear	



### ORDERING INFORMATION:

Component	Qty in box	MOQ	MPQ	Box weight (kg)
C14541_HB-2X2-RS » Box size: 480 x 280 x 300 mm	800	160	160	10.2

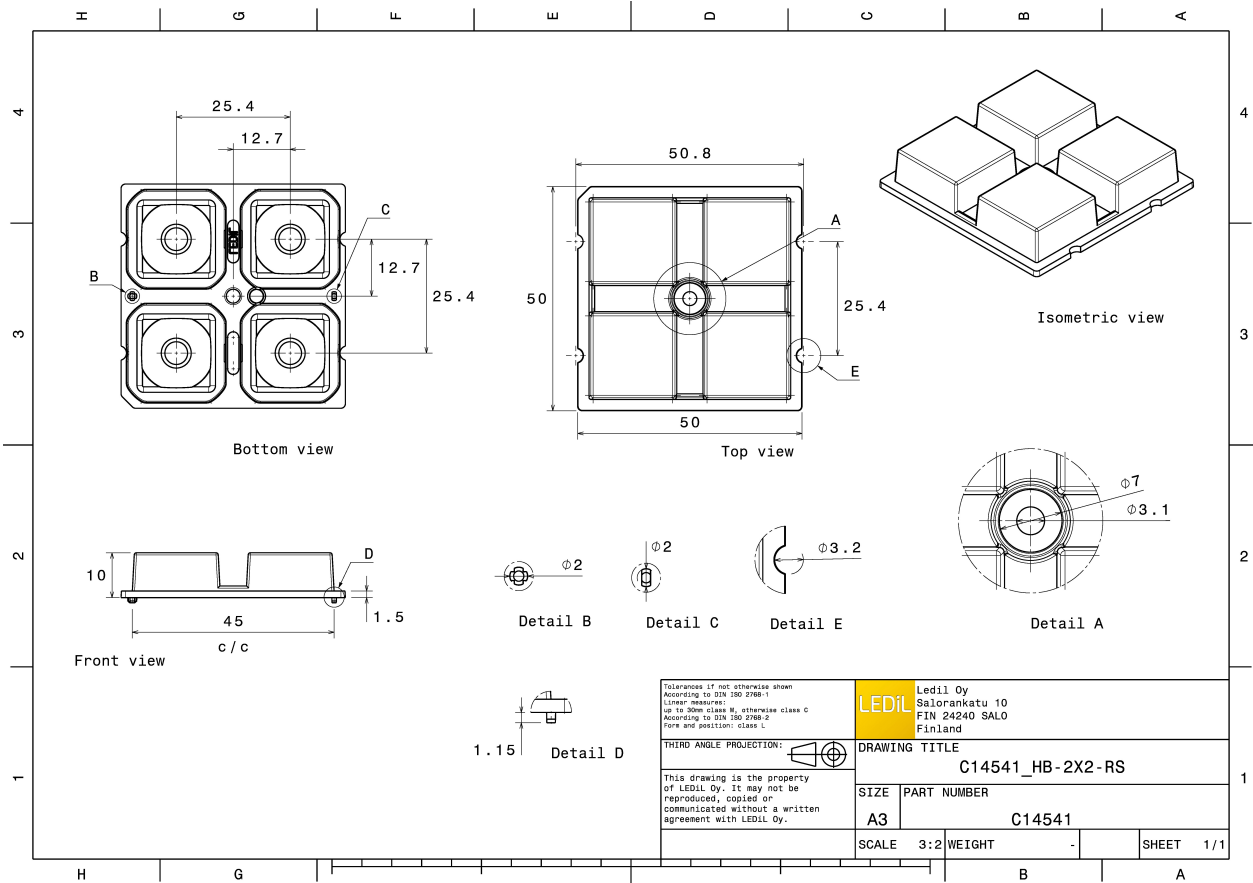

#### PHOTOMETRIC DATA (MEASURED):



LED QUICK FLUX XTP 2x6 xxx LS G5  
 FWHM 14.0°  
 Efficiency 94 %  
 Peak intensity 9.5 cd/lm  
 LEDs/each optic 1  
 Light colour White  
 Required components:

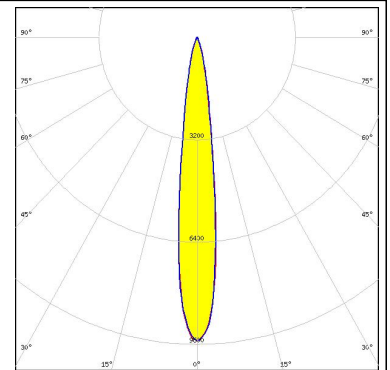
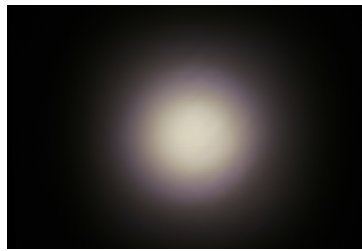

LED XD16  
 FWHM 11.0°  
 Efficiency 93 %  
 Peak intensity 13.5 cd/lm  
 LEDs/each optic 1  
 Light colour White  
 Required components:

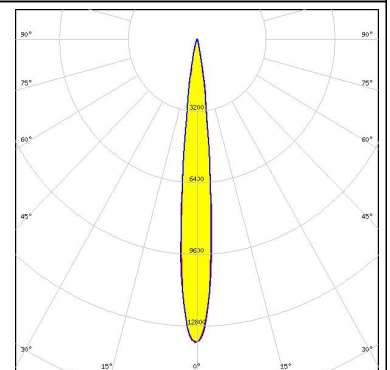

LED XHP35 HD  
 FWHM 24.0°  
 Efficiency 89 %  
 Peak intensity 4.1 cd/lm  
 LEDs/each optic 1  
 Light colour White  
 Required components:

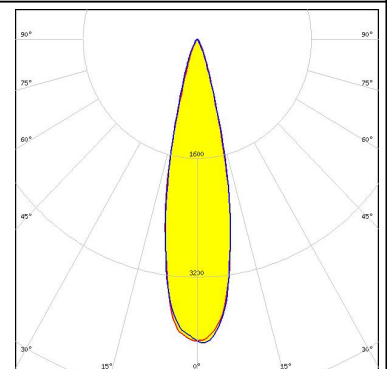
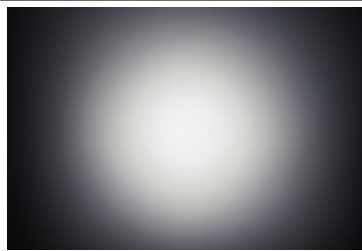

LED XP-E2  
 FWHM 10.0°  
 Efficiency 94 %  
 Peak intensity 22.1 cd/lm  
 LEDs/each optic 1  
 Light colour White  
 Required components:

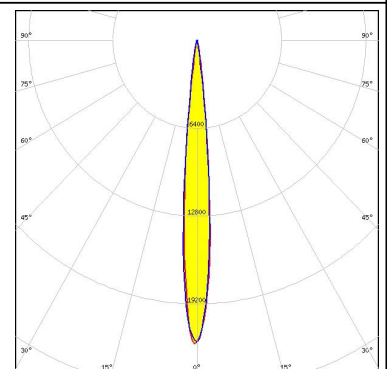

#### PHOTOMETRIC DATA (MEASURED):



LED XP-G2  
 FWHM 14.0°  
 Efficiency 94 %  
 Peak intensity 11.8 cd/Im  
 LEDs/each optic 1  
 Light colour White  
 Required components:

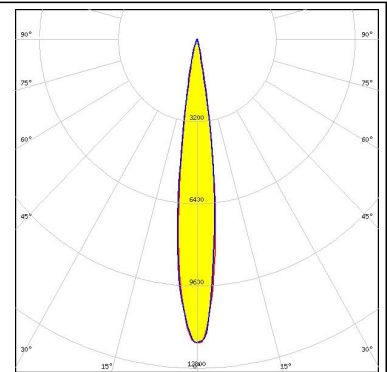

LED XP-L HI  
 FWHM 13.0°  
 Efficiency 94 %  
 Peak intensity 11.6 cd/Im  
 LEDs/each optic 1  
 Light colour White  
 Required components:

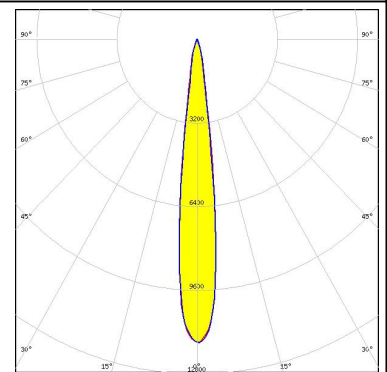
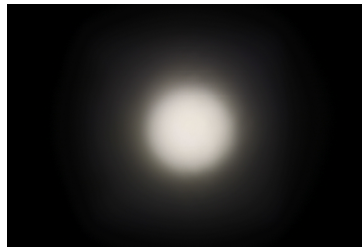

LED XP-L2  
 FWHM 21.0°  
 Efficiency 94 %  
 Peak intensity 4.5 cd/Im  
 LEDs/each optic 1  
 Light colour White  
 Required components:

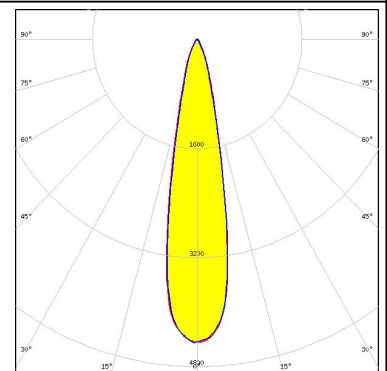

LED LUXEON V2  
 FWHM 15.0°  
 Efficiency 94 %  
 Peak intensity 9.5 cd/Im  
 LEDs/each optic 1  
 Light colour White  
 Required components:

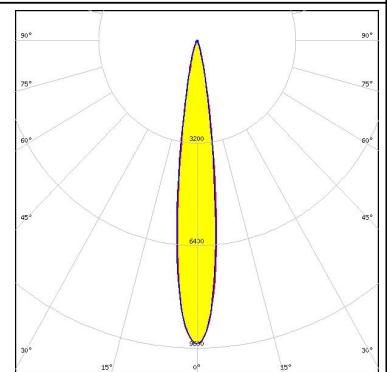

#### PHOTOMETRIC DATA (MEASURED):



LED SST-10-B130  
 FWHM 12.0°  
 Efficiency 96 %  
 Peak intensity 15.9 cd/lm  
 LEDs/each optic 1  
 Light colour Deep Red  
 Required components:

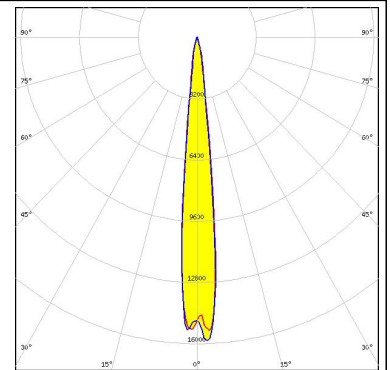

LED NVSW219D  
 FWHM 17.0°  
 Efficiency 94 %  
 Peak intensity 8.6 cd/lm  
 LEDs/each optic 1  
 Light colour White  
 Required components:

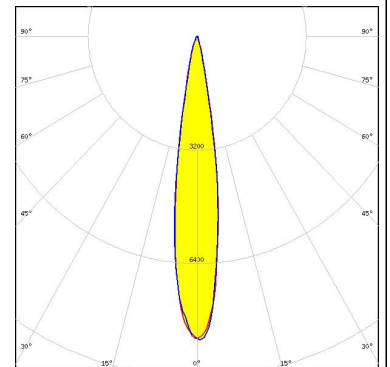



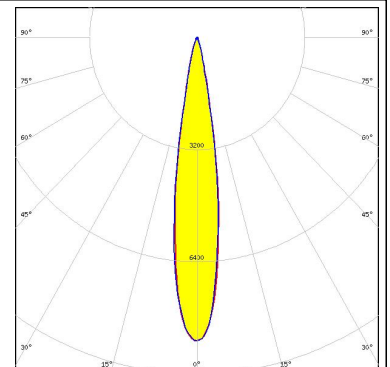
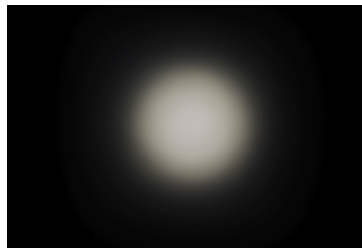

LED NVSW219F  
 FWHM 17.0°  
 Efficiency 94 %  
 Peak intensity 8.7 cd/lm  
 LEDs/each optic 1  
 Light colour White  
 Required components:

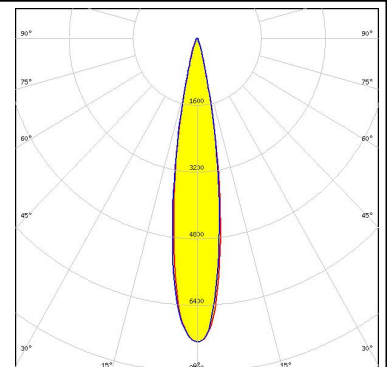
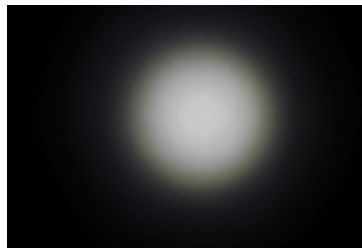

LED NVSW319B  
 FWHM 18.0°  
 Efficiency 94 %  
 Peak intensity 7.3 cd/lm  
 LEDs/each optic 1  
 Light colour White  
 Required components:

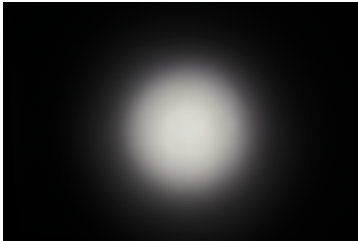
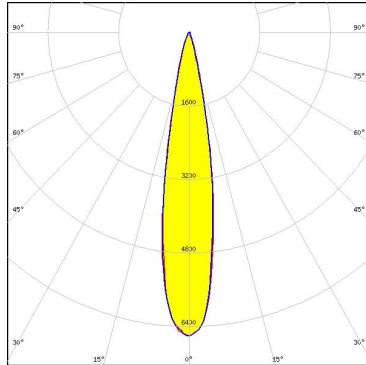

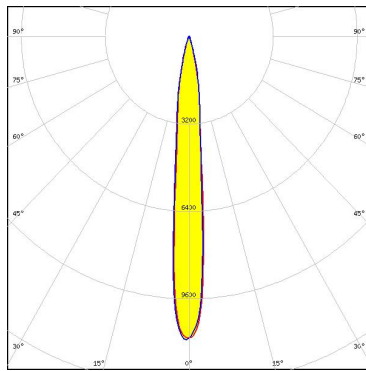
#### PHOTOMETRIC DATA (MEASURED):

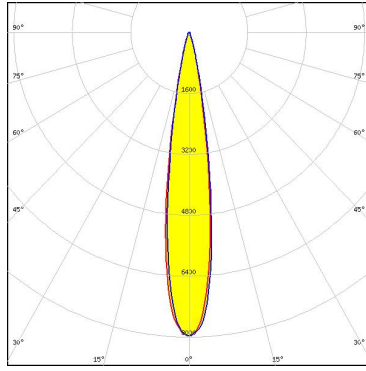
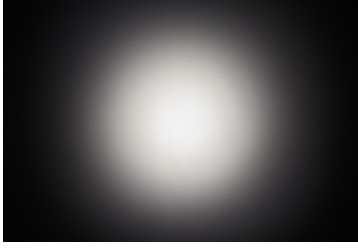
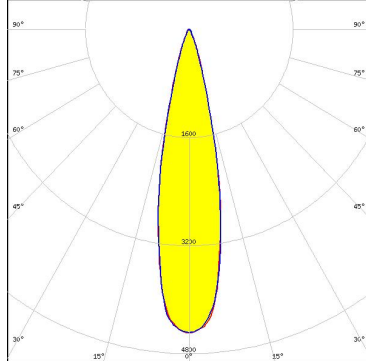
<p><b>NICHIA</b></p> <p>LED NVSW3x9A            FWHM 19.0°            Efficiency 94 %            Peak intensity 6.6 cd/lm            LEDs/each optic 1            Light colour White            Required components:</p>		
<p><b>NICHIA</b></p> <p>LED NVSxE21A            FWHM 11.0°            Efficiency 89 %            Peak intensity 11.1 cd/lm            LEDs/each optic 1            Light colour White            Required components:</p>		
<p><b>NICHIA</b></p> <p>LED NVSxx19B/NVSxx19C            FWHM 17.0°            Efficiency 93 %            Peak intensity 8 cd/lm            LEDs/each optic 1            Light colour White            Required components:</p>		
<p><b>NICHIA</b></p> <p>LED NWSx229A            FWHM 23.0°            Efficiency 94 %            Peak intensity 4.5 cd/lm            LEDs/each optic 1            Light colour White            Required components:</p>		

#### PHOTOMETRIC DATA (MEASURED):

#### OSRAM

Opto Semiconductors

LED OSLOM Square CSSRM2/CSSRM3  
 FWHM 15.0°  
 Efficiency 90 %  
 Peak intensity 11 cd/lm  
 LEDs/each optic 1  
 Light colour White  
 Required components:

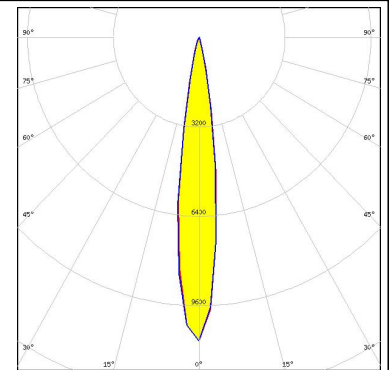

#### PHILIPS

LED Fortimo FastFlex LED 2x8 DA G4  
 FWHM 13.0°  
 Efficiency 93 %  
 Peak intensity 12.5 cd/lm  
 LEDs/each optic 1  
 Light colour White  
 Required components:

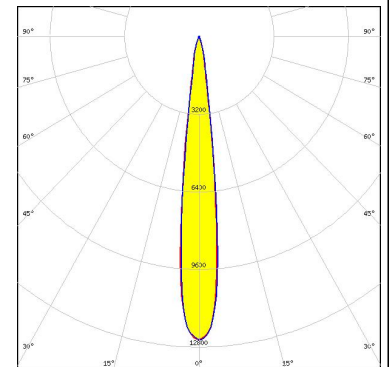

#### SAMSUNG

LED HiLOM RH16 (LH351C)  
 FWHM 17.0°  
 Efficiency 94 %  
 Peak intensity 8.1 cd/lm  
 LEDs/each optic 1  
 Light colour White  
 Required components:

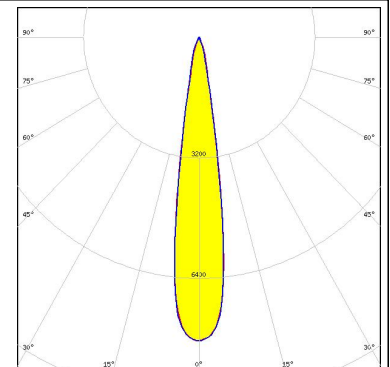
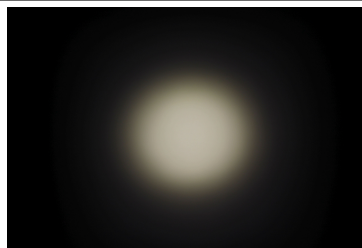

#### SAMSUNG

LED LH351B  
 FWHM 17.0°  
 Efficiency 89 %  
 Peak intensity 8 cd/lm  
 LEDs/each optic 1  
 Light colour White  
 Required components:

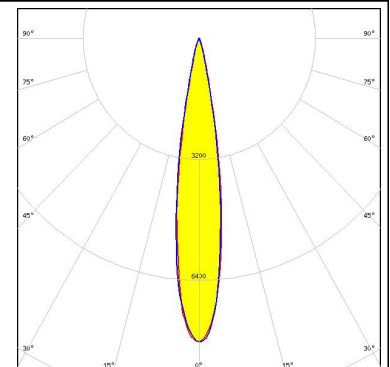

#### PHOTOMETRIC DATA (MEASURED):

#### SAMSUNG

LED LH351C  
 FWHM 18.0°  
 Efficiency 94 %  
 Peak intensity 7.9 cd/lm  
 LEDs/each optic 1  
 Light colour White  
 Required components:

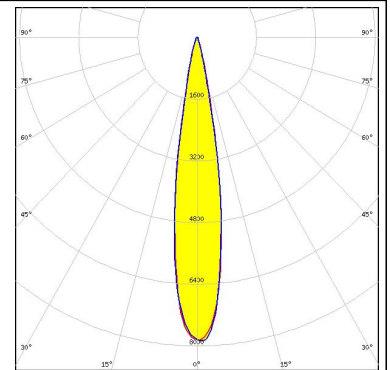

#### SAMSUNG

LED LH351D  
 FWHM 22.0°  
 Efficiency 94 %  
 Peak intensity 4.9 cd/lm  
 LEDs/each optic 1  
 Light colour White  
 Required components:

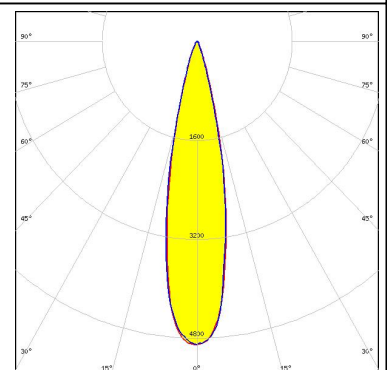
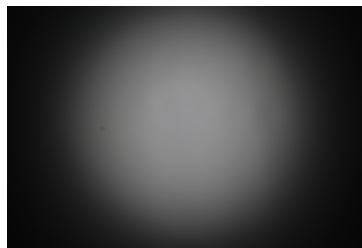

SEOUL SEMICONDUCTOR

LED Z5M3  
 FWHM 16.0°  
 Efficiency 94 %  
 Peak intensity 7.8 cd/lm  
 LEDs/each optic 1  
 Light colour White  
 Required components:

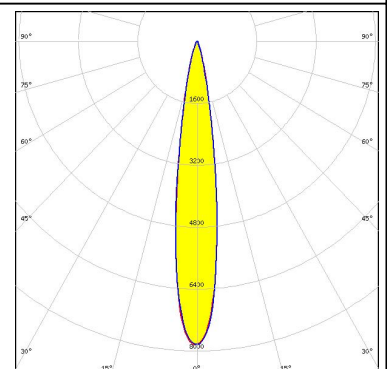
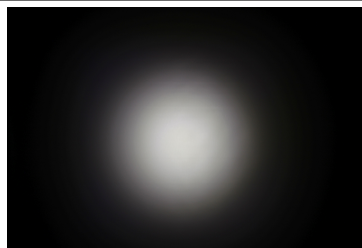

SEOUL SEMICONDUCTOR

LED Z5M4  
 FWHM 17.0°  
 Efficiency 96 %  
 Peak intensity 7.4 cd/lm  
 LEDs/each optic 1  
 Light colour White  
 Required components:

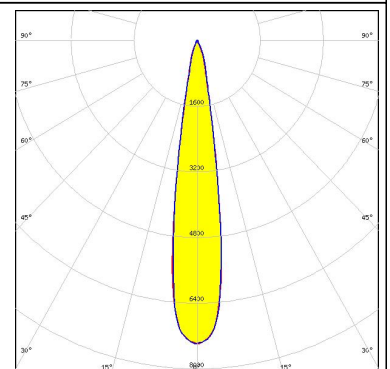

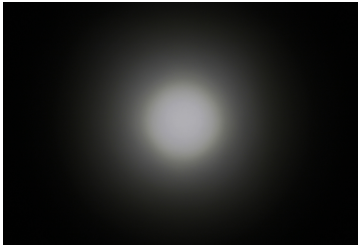
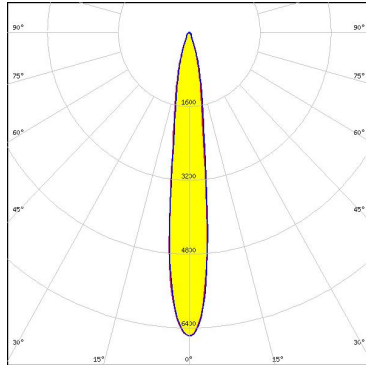
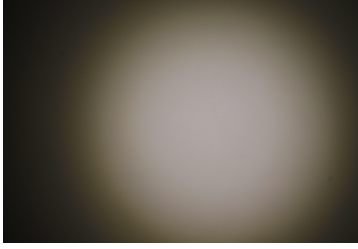
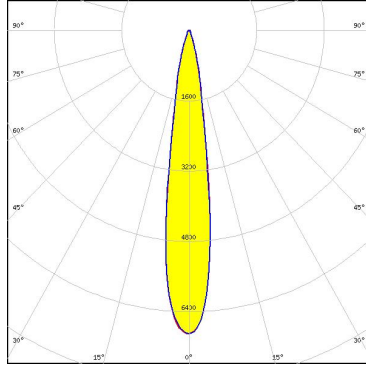
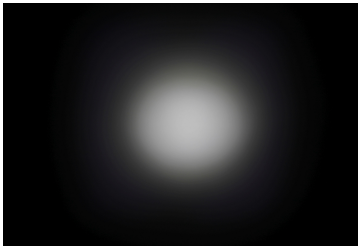
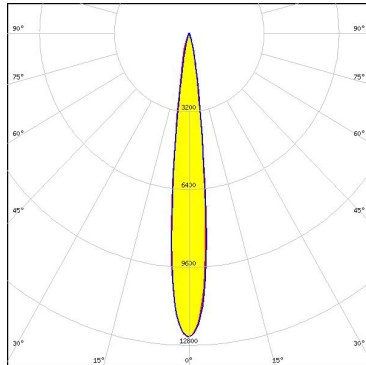

#### PHOTOMETRIC DATA (MEASURED):

<p><b>SEOL</b> SEOL SEMICONDUCTOR</p> <p>LED Z8Y22 FWHM 14.0° Efficiency 94 % Peak intensity 6.6 cd/lm LEDs/each optic 1 Light colour White Required components:</p>		
<p><b>SEOL</b> SEOL SEMICONDUCTOR</p> <p>LED Z8Y22P FWHM 16.0° Efficiency 93 % Peak intensity 6.9 cd/lm LEDs/each optic 1 Light colour White Required components:</p>		
<p><b>TRIDONIC</b></p> <p>LED RLE 2x4 2000lm HP EXC2 OTD FWHM 13.0° Efficiency 94 % Peak intensity 12.5 cd/lm LEDs/each optic 1 Light colour White Required components:</p>		
<p><b>TRIDONIC</b></p> <p>LED RLE 2x8 4000lm HP EXC2 OTD FWHM 13.0° Efficiency 94 % Peak intensity 12.5 cd/lm LEDs/each optic 1 Light colour White Required components:</p>		

#### PHOTOMETRIC DATA (MEASURED):

#### TRIDONIC

LED RLE G1 49x121mm 2000lm xxx EXC OTD  
 FWHM 13.0°  
 Efficiency 94 %  
 Peak intensity 10.9 cd/lm  
 LEDs/each optic 1  
 Light colour White  
 Required components:

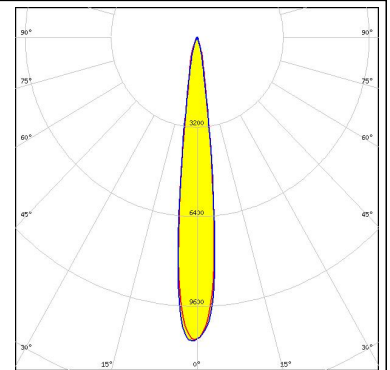

#### TRIDONIC

LED RLE G1 49x133mm 2000lm xxx EXC OTD  
 FWHM 13.0°  
 Efficiency 94 %  
 Peak intensity 10.9 cd/lm  
 LEDs/each optic 1  
 Light colour White  
 Required components:

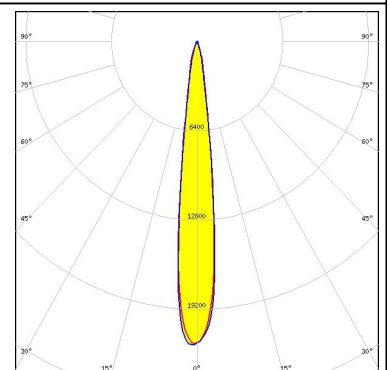

#### TRIDONIC

LED RLE G1 49x223mm 4000lm xxx EXC OTD  
 FWHM 13.0°  
 Efficiency 94 %  
 Peak intensity 10.9 cd/lm  
 LEDs/each optic 1  
 Light colour White  
 Required components:

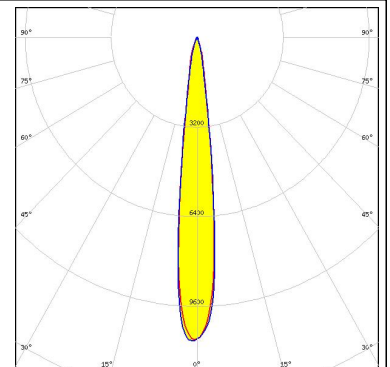
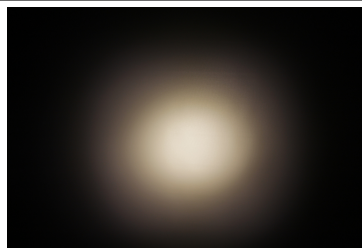

#### TRIDONIC

LED RLE G1 49x245mm 4000lm xxx EXC OTD  
 FWHM 13.0°  
 Efficiency 94 %  
 Peak intensity 10.9 cd/lm  
 LEDs/each optic 1  
 Light colour White  
 Required components:

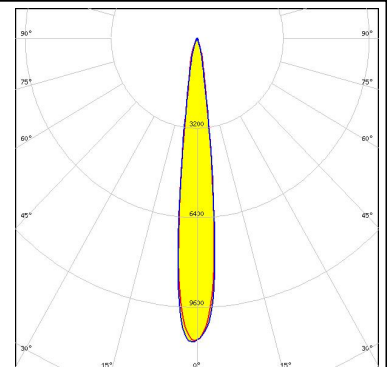
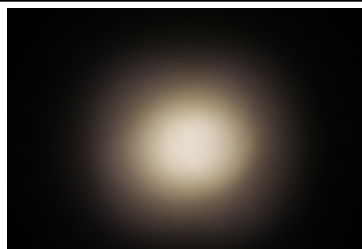

#### PHOTOMETRIC DATA (SIMULATED):



LED XHP35 HI  
 FWHM 14.0°  
 Efficiency 93 %  
 Peak intensity 9.9 cd/lm  
 LEDs/each optic 1  
 Light colour White  
 Required components:

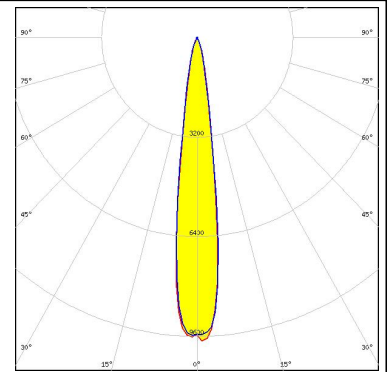

LED XM-L  
 FWHM 19.0°  
 Efficiency 92 %  
 Peak intensity 5.6 cd/lm  
 LEDs/each optic 1  
 Light colour White  
 Required components:

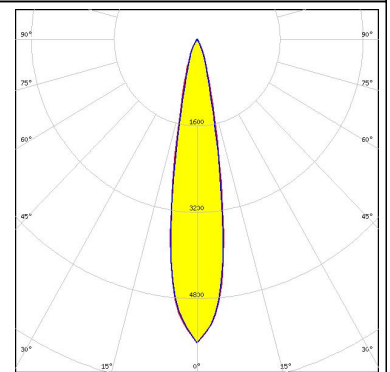

LED XM-L2  
 FWHM 18.0°  
 Efficiency 94 %  
 Peak intensity 6.9 cd/lm  
 LEDs/each optic 1  
 Light colour White  
 Required components:

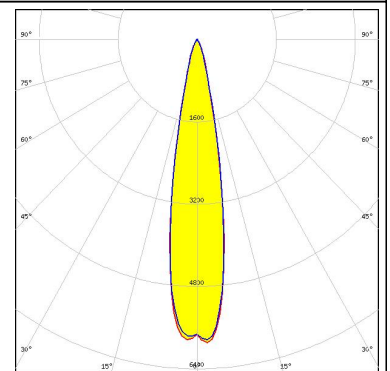

LED XP-G  
 FWHM 13.0°  
 Efficiency 93 %  
 Peak intensity 12.1 cd/lm  
 LEDs/each optic 1  
 Light colour White  
 Required components:

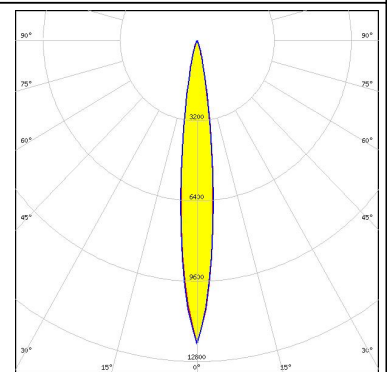

#### PHOTOMETRIC DATA (SIMULATED):



LED XP-G2  
 FWHM 12.0°  
 Efficiency 92 %  
 Peak intensity 12.8 cd/lm  
 LEDs/each optic 1  
 Light colour White

Required components:

Transparent protective cover

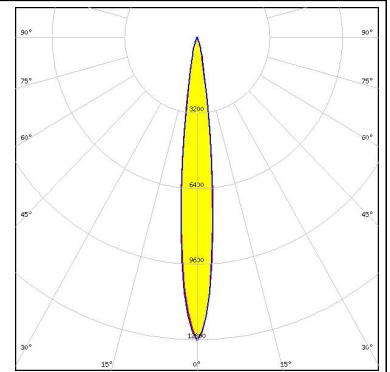

LED XP-G2 HE  
 FWHM 16.0°  
 Efficiency 94 %  
 Peak intensity 7.3 cd/lm  
 LEDs/each optic 1  
 Light colour White

Required components:

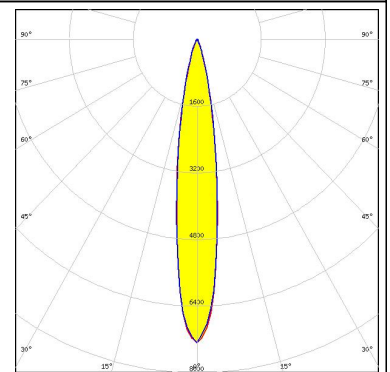

LED XP-G3  
 FWHM 16.0°  
 Efficiency 94 %  
 Peak intensity 7.9 cd/lm  
 LEDs/each optic 1  
 Light colour White

Required components:

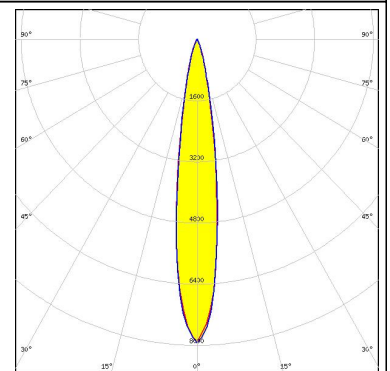

LED XP-L HD  
 FWHM 19.0°  
 Efficiency 94 %  
 Peak intensity 6.1 cd/lm  
 LEDs/each optic 1  
 Light colour White

Required components:

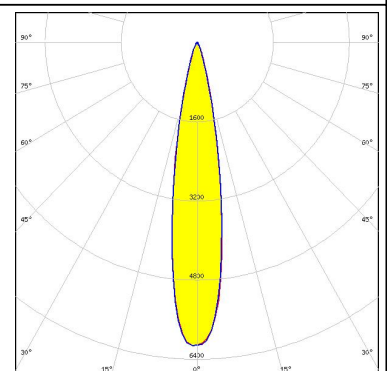

#### PHOTOMETRIC DATA (SIMULATED):



LED XP-L2  
 FWHM 20.0°  
 Efficiency 89 %  
 Peak intensity 4.7 cd/lm  
 LEDs/each optic 1  
 Light colour White  
 Required components:

Transparent protective cover

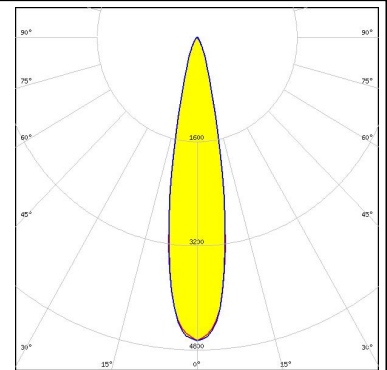

LED XQ-E HI  
 FWHM 8.0°  
 Efficiency 94 %  
 Peak intensity 28.3 cd/lm  
 LEDs/each optic 1  
 Light colour White  
 Required components:



LED LUXEON C  
 FWHM 11.0°  
 Efficiency 94 %  
 Peak intensity 16.2 cd/lm  
 LEDs/each optic 1  
 Light colour White  
 Required components:

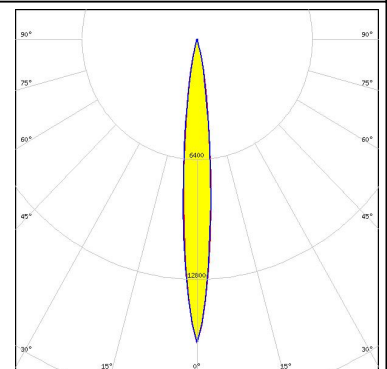

LED LUXEON IR Domed 150  
 FWHM 11.0°  
 Efficiency 94 %  
 Peak intensity 19.1 cd/lm  
 LEDs/each optic 1  
 Light colour White  
 Required components:

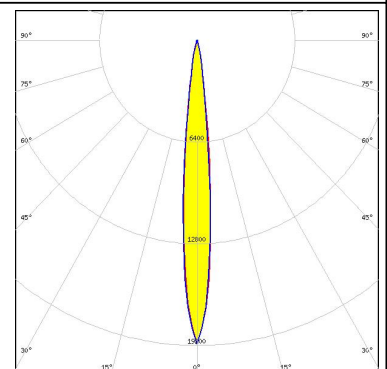

#### PHOTOMETRIC DATA (SIMULATED):

<p><b>LUMILEDS</b></p> <p>LED: LUXEON IR Domed 60            FWHM: 10.0°            Efficiency: 93 %            LEDs/each optic: 1            Light colour: White            Required components:</p>	
<p><b>NICHIA</b></p> <p>LED: NVSxx19B/NVSxx19C            FWHM: 16.0°            Efficiency: 94 %            Peak intensity: 8.8 cd/lm            LEDs/each optic: 1            Light colour: White            Required components:</p>	
<p><b>OSRAM</b>  <small>Opto Semiconductors</small></p> <p>LED: OSCONIQ P 3030            FWHM: 8.0°            Efficiency: 95 %            Peak intensity: 22.7 cd/lm            LEDs/each optic: 1            Light colour: White            Required components:</p>	
<p><b>OSRAM</b>  <small>Opto Semiconductors</small></p> <p>LED: OSCONIQ P 3737 (2W version)            FWHM: 12.0°            Efficiency: 90 %            Peak intensity: 12.5 cd/lm            LEDs/each optic: 1            Light colour: White            Required components:</p> <p>Transparent protective cover</p>	

#### PHOTOMETRIC DATA (SIMULATED):

#### OSRAM

Opto Semiconductors

LED OSCONIQ P 3737 (2W version)  
 FWHM 12.0°  
 Efficiency 95 %  
 Peak intensity 13.5 cd/lm  
 LEDs/each optic 1  
 Light colour White  
 Required components:

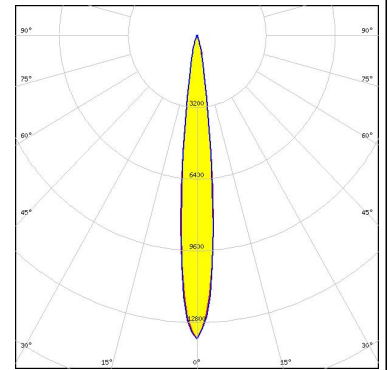

#### OSRAM

Opto Semiconductors

LED OSLON SSL 80  
 FWHM 8.2°  
 Efficiency 94 %  
 Peak intensity 21 cd/lm  
 LEDs/each optic 1  
 Light colour White  
 Required components:

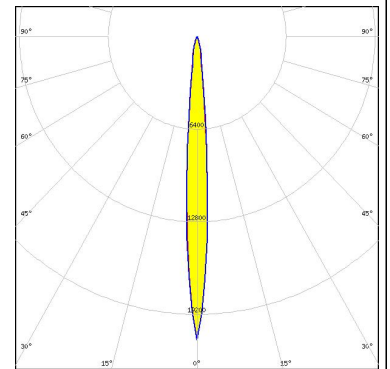

#### OSRAM

Opto Semiconductors

LED SFH 4715AS  
 FWHM 9.2°  
 Efficiency %  
 LEDs/each optic 1  
 Light colour IR  
 Required components:

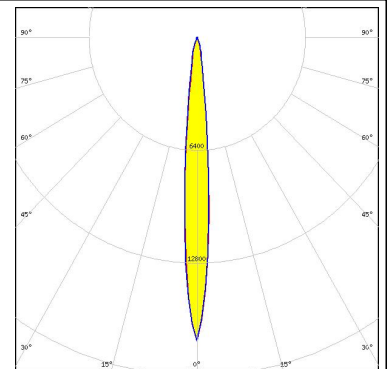

#### SAMSUNG

LED LH231B  
 FWHM 16.0°  
 Efficiency 94 %  
 Peak intensity 8 cd/lm  
 LEDs/each optic 4  
 Light colour White  
 Required components:

#### PHOTOMETRIC DATA (SIMULATED):

### SAMSUNG

LED LH231B  
 FWHM 16.0°  
 Efficiency 95 %  
 Peak intensity 8.3 cd/lm  
 LEDs/each optic 1  
 Light colour White  
 Required components:

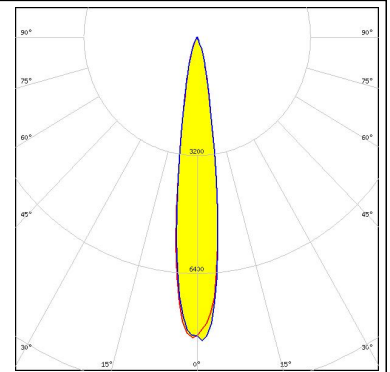

### SAMSUNG

LED LH231B  
 FWHM 16.0°  
 Efficiency 95 %  
 Peak intensity 8.4 cd/lm  
 LEDs/each optic 1  
 Light colour White  
 Required components:

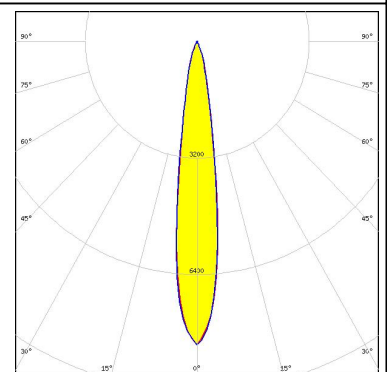

SEOUL SEMICONDUCTOR

LED Z5M1/Z5M2  
 FWHM 13.0°  
 Efficiency 92 %  
 Peak intensity 12.1 cd/lm  
 LEDs/each optic 1  
 Light colour White  
 Required components:

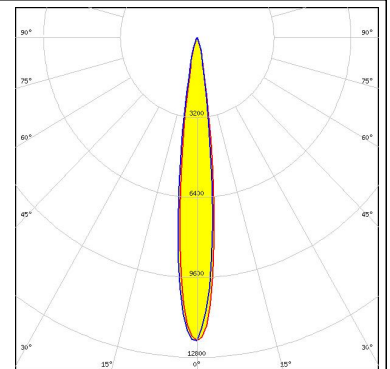

SEOUL SEMICONDUCTOR

LED Z8Y22T  
 FWHM 15.0°  
 Efficiency 94 %  
 Peak intensity 8.6 cd/lm  
 LEDs/each optic 1  
 Light colour White  
 Required components:

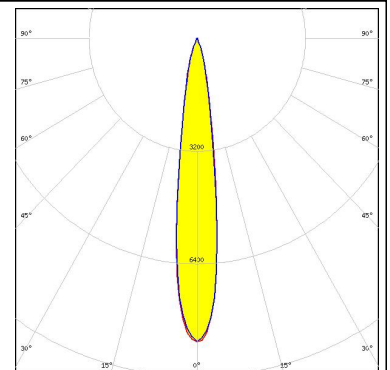



### GENERAL INFORMATION:

NOTE: The typical beam angle will be changed by different color, chip size and chip position tolerance. The typical total beam angle is the full angle measured where the luminous intensity is half of the peak value.

### MATERIALS:

As part of our continuous research and improvement processes, and to ensure the best possible quality and availability of our products, LEDiL reserves the right to change material grades without notice.

### PRODUCT DATA USER AGREEMENT AND DISCLAIMER:

The measured data in the provided downloadable LEDiL Product Datasheets and Mechanical 2D-Drawings is rounded and provided as reference for planning. LEDiL Oy's optical specifications have been verified by conducting performance testing of the products in accordance with the company's quality system. The reported data are averaged results of multiple measurements with typical variation. LEDiL Oy reserves the right to without prior notification make changes and improvements to its products.

LEDiL Oy assumes neither warranty, nor guarantee nor any other liability of any kind for the contents and correctness of the provided data. The provided data has been generated with highest diligence but the provided data may in reality not represent the complete possible variation range of all intrinsic parameters. Therefore, in certain cases a deviation from the provided data could occur.

LEDiL Oy reserves the right to undertake technical changes of its products without further notification which could lead to changes in the provided data. LEDiL Oy assumes no liability of any kind for the possible deviation from any provided data or any other damage resulting from the usage of the provided data.

The user agrees to this disclaimer and user agreement with the download or usage of the provided files.

#### LEDiL Oy

Joensuunkatu 13  
FI-24240 SALO  
Finland

#### LEDiL Inc.

228 West Page Street  
Suite D  
Sycamore IL 60178  
USA

#### Local sales and technical support

[www.ledil.com/  
where\\_to\\_buy](http://www.ledil.com/where_to_buy)

#### Shipping locations

Salo, Finland  
Hong Kong, China

#### Distribution Partners

[www.ledil.com/  
where\\_to\\_buy](http://www.ledil.com/where_to_buy)