

LOC	DIST	REVISIONS					
E	B	P	LTR	DESCRIPTION	DATE	DWN	APVD
			BA	NEW RELEASE	04-NOV-08	SM	St.P

FOR FURTHER INFORMATION SEE DATA SHEET FOR
CRG SERIES-THICK FILM CHIP RESISTORS

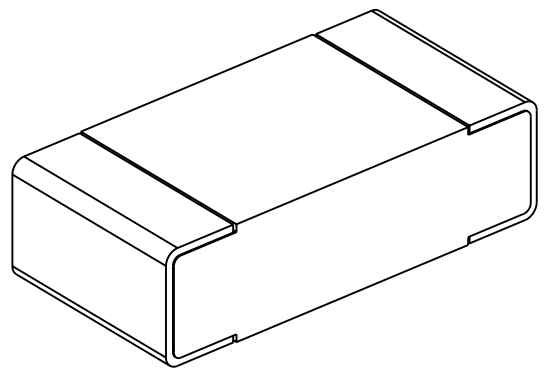

RoHS Compliant

2008

RELEASED FOR PUBLICATION

THIS DRAWING IS UNPUBLISHED.

BY TYCO ELECTRONICS CORPORATION. ALL RIGHTS RESERVED.



DIMENSIONS: mm	DWN SUBHASH.M	04-NOV-08	MATERIAL	-	FINISH	-
	CHK PRAKASH.S	04-NOV-08	Tyco Electronics Corporation Dorcan, Swindon, SN3 5HH			
TOLERANCES UNLESS OTHERWISE SPECIFIED:	APVD STEPHEN.P	04-NOV-08				
0 PLC ±0.5	PRODUCT SPEC	-	NAME THICK FILM CHIP RESISTORS SERIES CRG 0603			
1 PLC ±0.2	APPLICATION SPEC	-				
2 PLC ±0.1	WEIGHT	-	SIZE	CAGE CODE	DRAWING NO	RESTRICTED TO
3 PLC ±-			A 4	00779	©- 1622912	-
4 PLC ±-			CUSTOMER DRAWING			
ANGLES ±5°			SCALE	40:1	SHEET	1 OF 1
						REV BA