

InGaP HBT GAIN BLOCK MMIC AMPLIFIER, DC - 8 GHz

Typical Applications

The HMC311SC70(E) is ideal for:

- Cellular / PCS / 3G
- WiBro / WiMAX / 4G
- Fixed Wireless & WLAN
- CATV & Cable Modem
- Microwave Radio & Test Equipment

Features

- P1dB Output Power: +15 dBm
- Output IP3: +30 dBm
- Gain: 15 dB
- Cascadable, 50 Ohm I/O's
- Single Supply: +5V
- Industry Standard SC70 Package

Functional Diagram

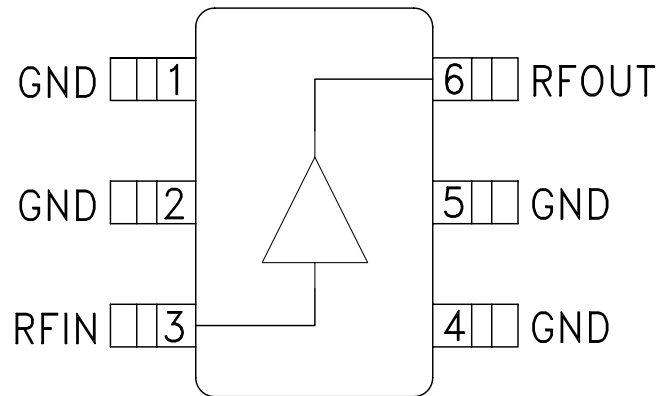

General Description

The HMC311SC70(E) is a GaAs InGaP Heterojunction Bipolar Transistor (HBT) Gain Block MMIC SMT DC to 8 GHz amplifier. Packaged in an industry standard SC70, the amplifier can be used as either a cascadable 50 Ohm gain stage or to drive the LO port of HMC mixers with up to +15 dBm output power. The HMC311SC70(E) offers 15 dB of gain and an output IP3 of +30 dBm while requiring only 54 mA from a +5V supply. The Darlington topology results in reduced sensitivity to normal process variations, and yields excellent gain stability over temperature while requiring a minimal number of external bias components.

Electrical Specifications, $V_s = 5V$, $R_{bias} = 22\ \Omega$, $T_A = +25^\circ\ C$

Parameter		Min.	Typ.	Max.	Units
Gain	DC - 1.0 GHz	14.0	15.0		dB
	1.0 - 4.0 GHz	13.0	15.0		dB
	4.0 - 6.0 GHz	12.5	14.5		dB
	6.0 - 8.0 GHz	11.0	13.0		dB
Gain Variation Over Temperature	DC - 1.0 GHz		0.004	0.007	dB/ °C
	1.0 - 4.0 GHz		0.007	0.012	dB/ °C
	4.0 - 6.0 GHz		0.012	0.016	dB/ °C
	6.0 - 8.0 GHz		0.018	0.022	dB/ °C
Return Loss Input / Output	DC - 8.0 GHz		15		dB
Reverse Isolation	DC - 8.0 GHz		18		dB
Output Power for 1 dB Compression (P1dB)	DC - 2.0 GHz	13.5	15.5		dBm
	2.0 - 4.0 GHz	12.0	15.0		dBm
	4.0 - 6.0 GHz	10.0	13.0		dBm
	6.0 - 8.0 GHz	8.0	11.0		dBm
Output Third Order Intercept (IP3)	DC - 2.0 GHz		30		dBm
	2.0 - 6.0 GHz		27		dBm
	6.0 - 8.0 GHz		24		dBm
Noise Figure	DC - 8.0 GHz		5		dB
Supply Current (Icq)			55	74	mA

Note: Data taken with broadband bias tee on device output.

**InGaP HBT GAIN BLOCK
MMIC AMPLIFIER, DC - 8 GHz**

Broadband Gain & Return Loss

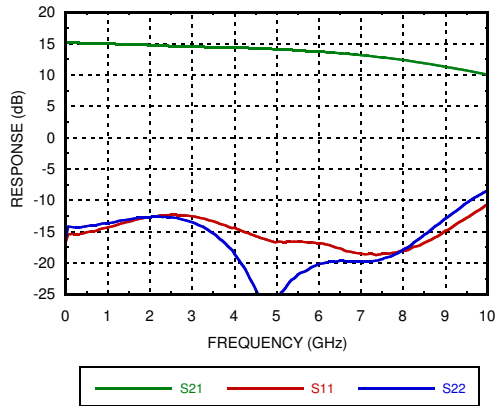

Gain vs. Temperature

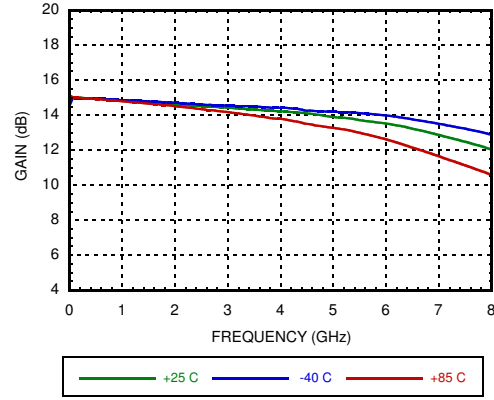

Input Return Loss vs. Temperature

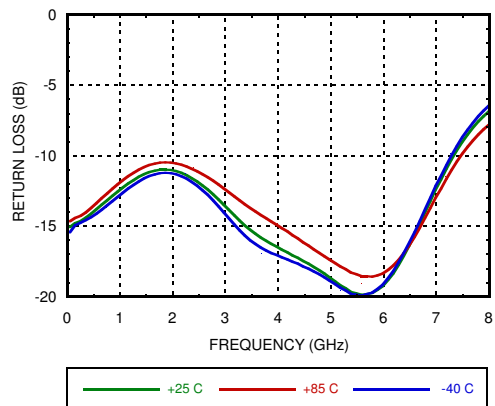

Output Return Loss vs. Temperature

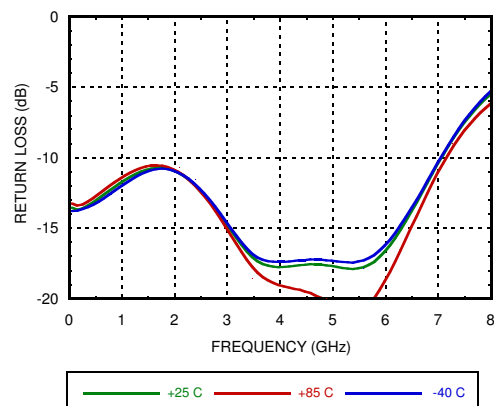

Reverse Isolation vs. Temperature

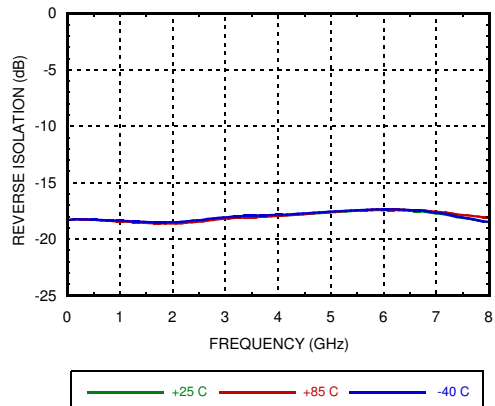

Noise Figure vs. Temperature

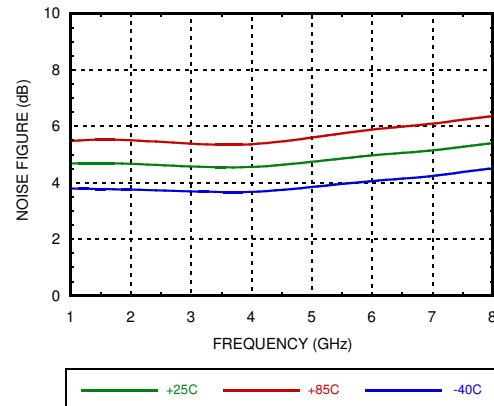

**InGaP HBT GAIN BLOCK
MMIC AMPLIFIER, DC - 8 GHz**

P1dB vs. Temperature

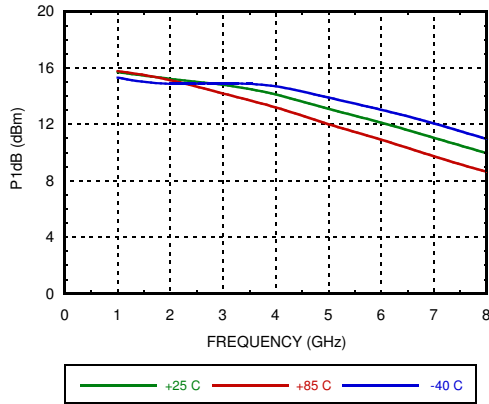

Psat vs. Temperature

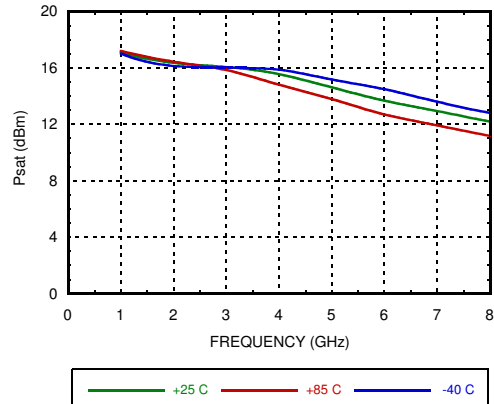

Power Compression @ 1 GHz

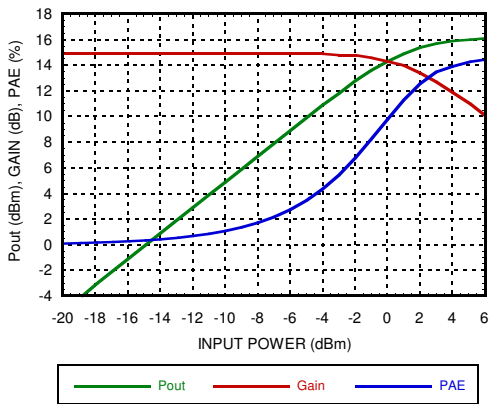

Power Compression @ 6 GHz

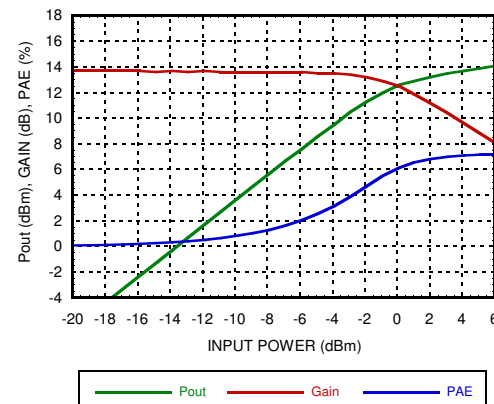

Output IP3 vs. Temperature

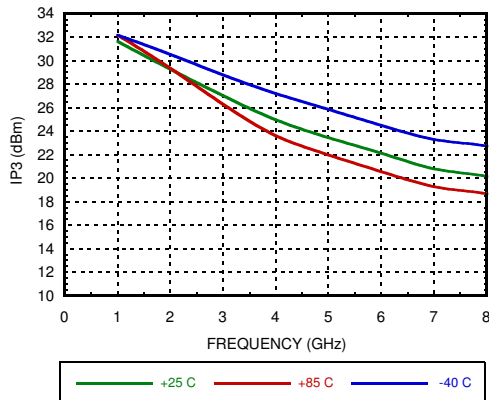

Gain, Power, IP3 & Supply Current vs. Supply Voltage @ 1 GHz

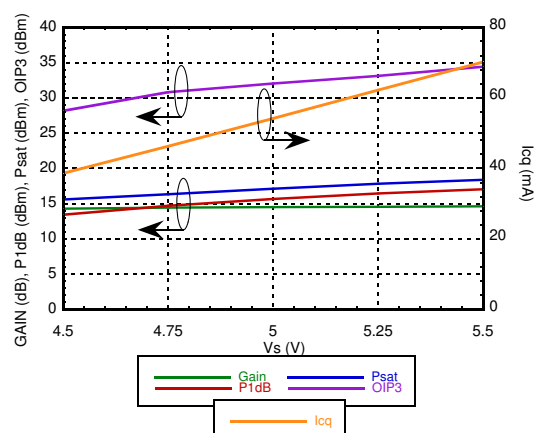

InGaP HBT GAIN BLOCK MMIC AMPLIFIER, DC - 8 GHz

Absolute Maximum Ratings

Collector Bias Voltage (Vcc)	+7V
RF Input Power (RFIN)(Vcc = +3.9V)	+10 dBm
Junction Temperature	150 °C
Continuous P _{diss} (T = 85 °C) (derate 5.21 mW/°C above 85 °C)	0.34 W
Thermal Resistance (junction to lead)	191 °C/W
Storage Temperature	-65 to +150 °C
Operating Temperature	-40 to +85 °C
ESD Sensitivity (HBM)	Class1A, Passed 250V



ELECTROSTATIC SENSITIVE DEVICE
OBSERVE HANDLING PRECAUTIONS

Outline Drawing

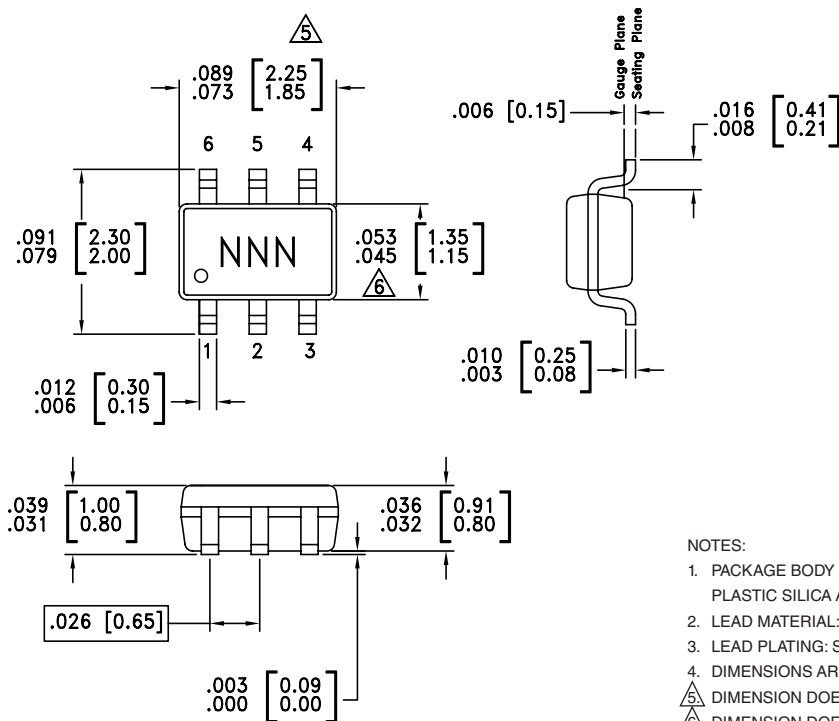

NOTES:

1. PACKAGE BODY MATERIAL: LOW STRESS INJECTION MOLDED PLASTIC SILICA AND SILICON IMPREGNATED.
2. LEAD MATERIAL: COPPER ALLOY
3. LEAD PLATING: Sn/Pb
4. DIMENSIONS ARE IN INCHES [MILLIMETERS].
- △ DIMENSION DOES NOT INCLUDE MOLDFLASH OF 0.15mm PER SIDE.
- △ DIMENSION DOES NOT INCLUDE MOLDFLASH OF 0.25mm PER SIDE.
7. ALL GROUND LEADS MUST BE SOLDERED TO PCB RF GROUND.

Package Information

Part Number	Package Body Material	Lead Finish	MSL Rating	Package Marking
HMC311SC70	Low Stress Injection Molded Plastic	Sn/Pb	MSL1 ^[1]	311
HMC311SC70E	RoHS-compliant Low Stress Injection Molded Plastic	100% matte Sn	MSL1 ^[2]	311E

[1] Max peak reflow temperature of 235°C

[2] Max peak reflow temperature of 260°C

InGaP HBT GAIN BLOCK MMIC AMPLIFIER, DC - 8 GHz

Pin Descriptions

Pin Number	Function	Description	Interface Schematic
1, 2, 4, 5	GND	These pins must be connected to RF/DC ground.	
3	RFIN	This pin is DC coupled. An off chip DC blocking capacitor is required.	
6	RFOUT	RF output and DC Bias for the output stage.	

Application Circuit

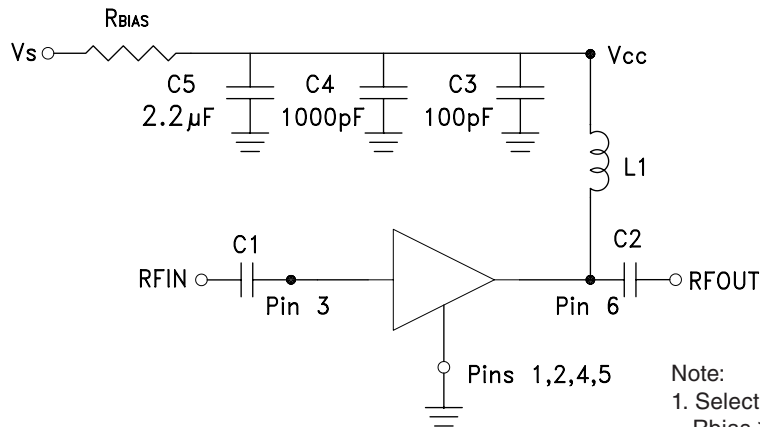

Note:

1. Select Rbias to achieve I_{cq} using equation below, $R_{bias} \geq 22 \text{ Ohm}$.
2. External blocking capacitors are required on RFIN and RFOUT.

$$I_{cq} = \frac{V_s - 3.8}{R_{bias}}$$

Recommended Component Values

Component	Frequency (MHz)							
	50	900	1900	2200	2400	3500	5200	5800
L1	270 nH	56 nH	22 nH	22 nH	15 nH	8.2 nH	3.3 nH	3.3 nH
C1, C2	0.01 μF	100 pF	100 pF	100 pF	100 pF	100 pF	100 pF	100 pF

**InGaP HBT GAIN BLOCK
MMIC AMPLIFIER, DC - 8 GHz**

Evaluation PCB

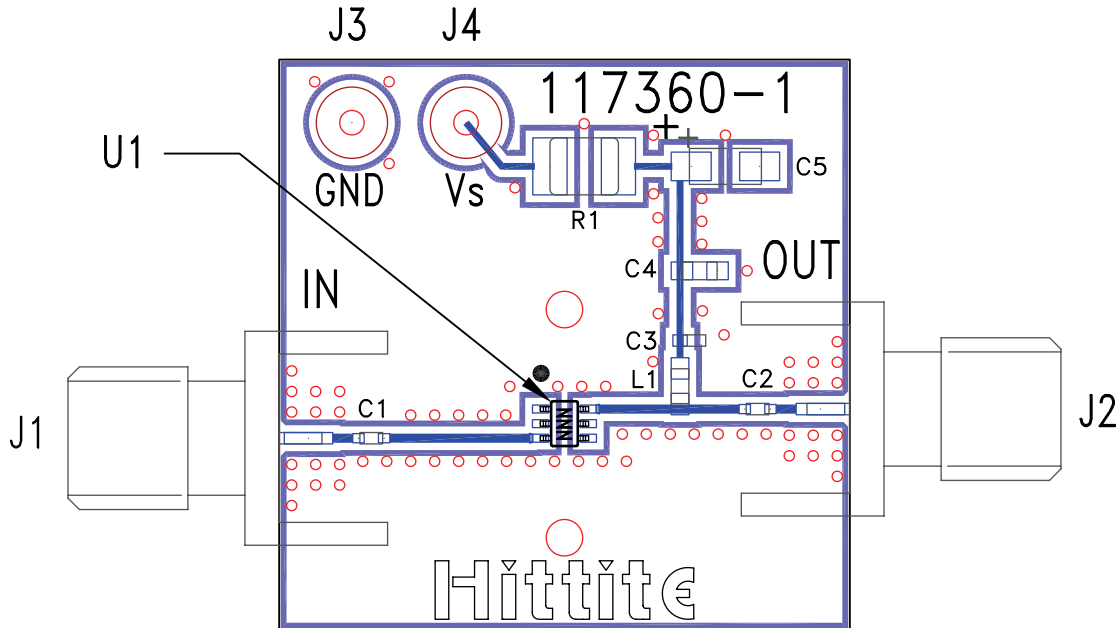

List of Materials for Evaluation PCB 118040 [1]

Item	Description
J1 - J2	PCB Mount SMA Connector
J3 - J4	DC Pin
C1 - C3	100 pF Capacitor, 0402 Pkg.
C4	1000 pF Capacitor, 0603 Pkg.
C5	2.2 μ F Capacitor, Tantalum
R1	22 Ohm Resistor, 1210 Pkg.
L1	22 nH Inductor, 0603 Pkg.
U1	HMC311SC70 / HMC311SC70E
PCB [2]	117360 Evaluation PCB

[1] Reference this number when ordering complete evaluation PCB

[2] Circuit Board Material: Rogers 4350

The circuit board used in the final application should use RF circuit design techniques. Signal lines should have 50 Ohm impedance while the package ground leads should be connected directly to the ground plane similar to that shown. A sufficient number of via holes should be used to connect the top and bottom ground planes. The evaluation board should be mounted to an appropriate heat sink. The evaluation circuit board shown is available from Analog Devices upon request.