

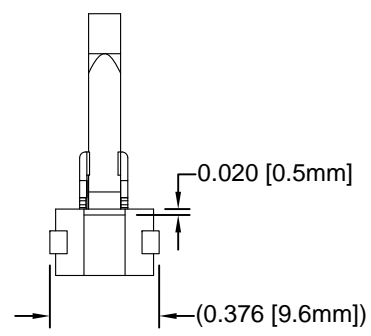

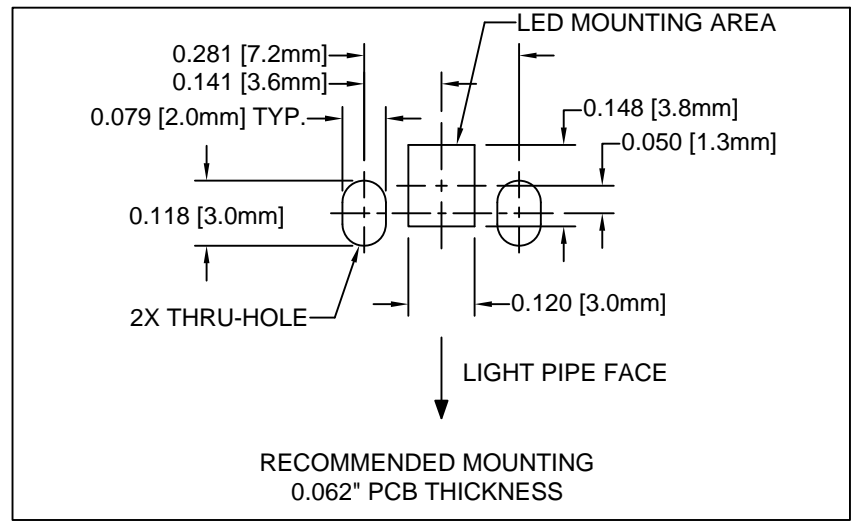

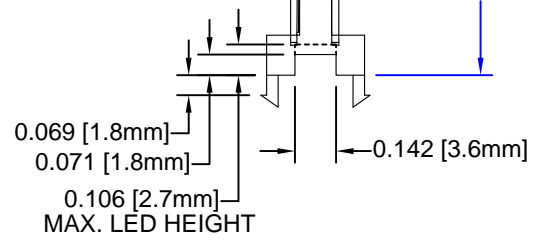





ITEM	Q'TY	PART NUMBER	PART DESCRIPTION
1	1	LPR1-XXX-XXX	Surface Mount Right Angle Light Pipe, 2.8mm, Single Station. See Table on 2nd Page
2	1	RLPH1-XXX	LPR Housing, Single Station, White. See Table on 2nd Page



REV.	DESCRIPTION	DATE	APPROVED
A	Engineering Release	11/06/09	T. Y.
B	Added Overall Height "K" Dim	03/04/11	T. Y.
C	Added Overall Snap Height Dimension	08/15/12	T. Y.
D	Added Color Options, Sheet #3	02/02/16	J. C.



STANDARD TOLERANCE (UNLESS OTHERWISE SPECIFIED)		BIVAR [®] 4 THOMAS, IRVINE, CA. 92618 TEL: (949) 951-8808 FAX: (949) 951-3974	
DECIMALS	ANGULAR		
.X ± .1	X° ± 1°	TITLE: RIGHT ANGLE LIGHT PIPE, 2.8MM, SINGLE STATION PART NO: RLP1-XXX-XXX REVISION: D	
.XX ± .01			
.XXX ± .010		DESIGNED: Raffy Paje DATE: 11/06/09 CHECKED: T. Yin DATE: 11/06/09	
		CAGE CODE : 32559 SHEET # 1 OF 3	
CAD GENERATED DOCUMENT. DO NOT MEASURE DRAWING.			

REV.	DESCRIPTION	DATE	APPROVED
	SEE SHEET #1		

RLP1-XXX-XXX						
ASSY P/N	H	L	K	LPR1-XXX-XXX	RLPH1-XXX	FIGURE
RLP1-200-500	0.197 [5.0mm]	0.551 [14.0 mm]	0.287 [7.3mm]	LPR1-200-500	RLPH1-200	
RLP1-200-650		0.669 [17.0mm]		LPR1-200-650	RLPH1-200	
RLP1-200-800		0.787 [20.0mm]		LPR1-200-800	RLPH1-200	
RLP1-400-500	0.394 [10.0mm]	0.551 [14.0 mm]	0.484 [12.3mm]	LPR1-400-500	RLPH1-400	
RLP1-400-650		0.669 [17.0mm]		LPR1-400-650	RLPH1-400	
RLP1-400-800		0.787 [20.0mm]		LPR1-400-800	RPH1-400	
RLP1-600-500	0.591 [15.0mm]	0.551 [14.0 mm]	0.681 [17.3mm]	LPR1-600-500	RLPH1-600	
RLP1-600-650		0.669 [17.0mm]		LPR1-600-650	RLPH1-600	
RLP1-600-800		0.787 [20.0mm]		LPR1-600-800	RLPH1-600	

STANDARD TOLERANCE (UNLESS OTHERWISE SPECIFIED)		 BIVAR [®] 4 THOMAS, IRVINE, CA. 92618 TEL: (949) 951-8808 FAX: (949) 951-3974	
DECIMALS	ANGULAR		
.X ± .1	X° ± 1°	 TITLE: RIGHT ANGLE LIGHT PIPE, 2.8MM, SINGLE STATION	
.XX ± .01			
.XXX ± .010			
DESIGNED: Raffy Paje	DATE: 11/06/09	PART NO: RLP1-XXX-XXX	REVISION: D
CHECKED: T. Yin	DATE: 11/06/09	CAGE CODE : 32559	SHEET # 2 OF 3
CAD GENERATED DOCUMENT. DO NOT MEASURE DRAWING.			

OTHER AVAILABLE COLORS

* SEE TABLE FOR ORDERING INFORMATION

REV.	DESCRIPTION	DATE	APPROVED
	SEE SHEET #1		

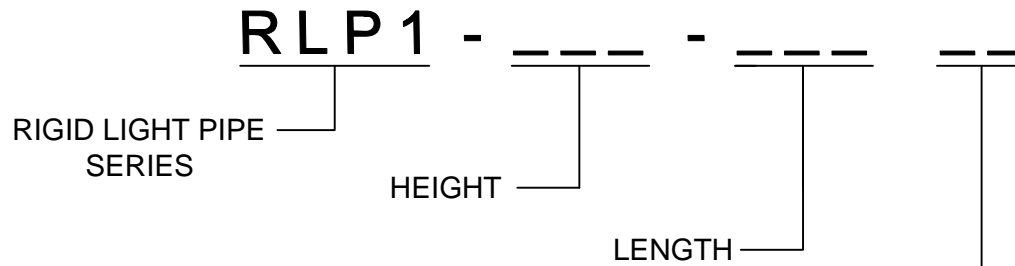

COLOR	Order Code
BLUE	BE
BLACK	BK
GREEN	GN
GRAY	GY
RED	RD
YELLOW	YW

NOTE: LEAVE ORDER CODE BLANK IF NO COLOR IS DESIRED.

- 2. ONLY LIGHT PIPES OF ASSEMBLIES WILL BE DYED.
- 1. PARTS ARE DYED TO COLOR UPON REQUEST.

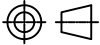
STANDARD TOLERANCE (UNLESS OTHERWISE SPECIFIED) DECIMALS ANGULAR		 4 THOMAS, IRVINE, CA. 92618 TEL: (949) 951-8808 FAX: (949) 951-3974	
			
DESIGNED: K. Aukshunas	DATE: 01/22/16	TITLE: RIGHT ANGLE LIGHT PIPE, 2.8 MM, SINGLE STATION	
CHECKED: J. Chiang	DATE: 01/22/16	PART NO: RLP1-XXX-XXX	REVISION: D
		CAGE CODE : 32559	SHEET # 3 OF 3
CAD GENERATED DOCUMENT. DO NOT MEASURE DRAWING.			