

# D'Sub Metallic Hoods

DTZK & DVZK series



## MAIN CHARACTERISTICS

- **Material and plating:**  
Zinc die-cast, nickel plated
- **Cable strainrelief:**  
Steel fiber reinforced Polycarbonate UL94V-O
- **Temperature range:**  
-40°C to 120°C
- **Cable diameter:**  
3 to 13mm
- **Attenuation factor:**  
> 40 dB between 30 MHz and 1 GHz
- **Approvals:**  
VDE 0871 - FCC 20780 - 89 / 336 / EU

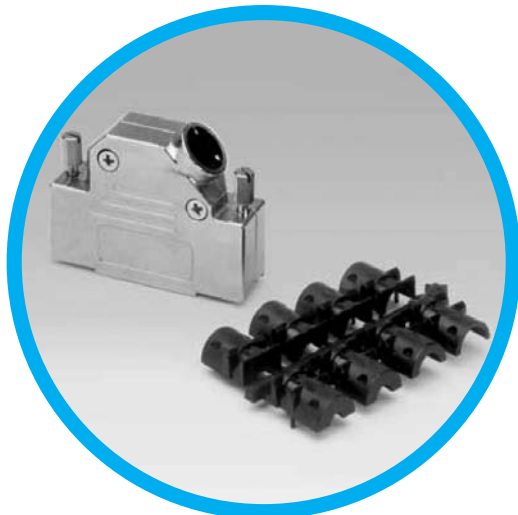

## DESCRIPTION

Amphenol metallic hood series for D'Sub connectors offers protection from magnetic and radio interference to cable assemblies.

Easily assembled these hoods are suitable for all industrial and telecom applications.

*Shield  
Your cable  
assemblies!*

## APPLICATIONS

- Industrial
- Military
- Telecom
- Any application requiring EMI/RFI protection



**Amphenol**

**D'SUB ACCESSORIES / E23**

### DTZK Series



Part number	A	B
<b>L17DTZK9Kxx</b>	21 (.827")	38.3 (1.508")
<b>L17DTZK15Kxx</b>	39.5 (1.555")	40.5 (1.594")
<b>L17DTZK25Kxx</b>	54.4 (2.144")	47.3 (1.862")
<b>L17DTZK37Kxx</b>	70.9 (2.791")	52.2 (2.055")

xx = Blank for plastic knob and FM for metal knob

### DVZK Series

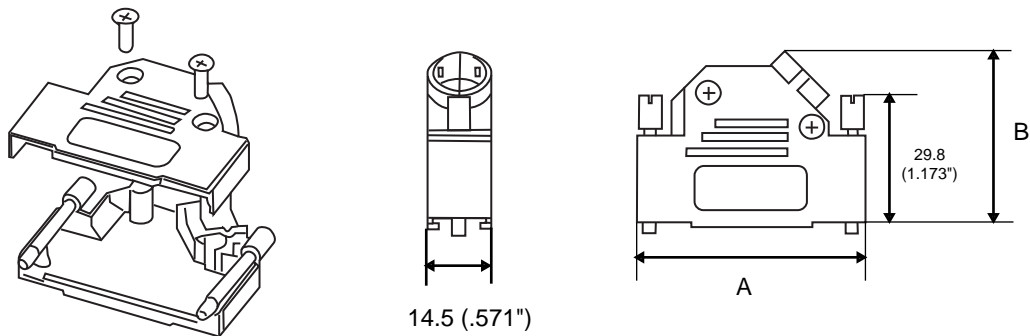

Part number	A	B
<b>L17DVZK9Kxx</b>	31 (1.220")	36,2 (1.425")
<b>L17DVZK15Kxx</b>	39,5 (1.555")	40,2 (1.583")
<b>L17DVZK25Kxx</b>	53,2 (2.094")	40,2 (1.583")
<b>L17DVZK37Kxx</b>	69,7 (2.744")	40,2 (1.583")

xx = Blank for plastic knob and FM for metal knob

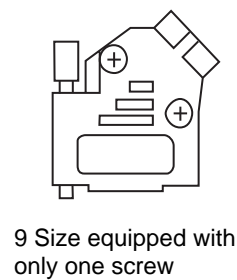

9 Size equipped with only one screw

# Assembly Instructions DTZK Series

Type	A
L17DTZK9Kxx	30
L17DTZK15Kxx	(1.181")
L17DTZK25Kxx	40
L17DTZK37Kxx	(1.575")

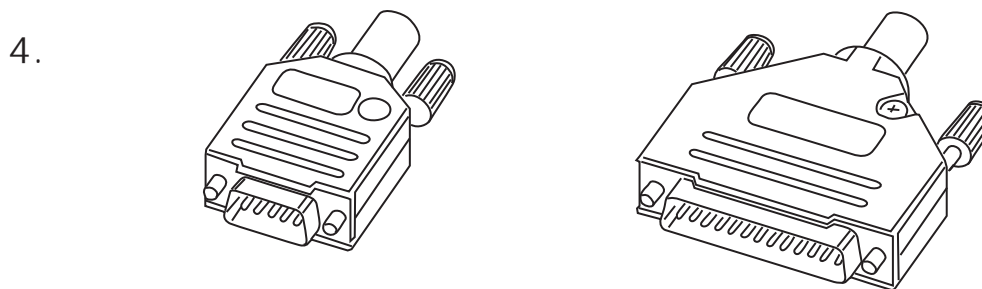
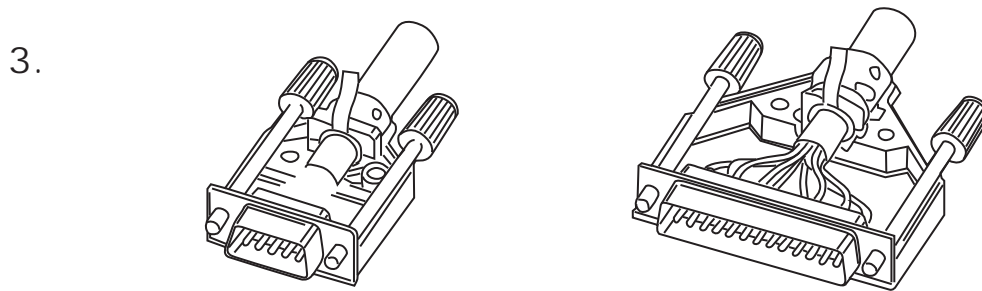
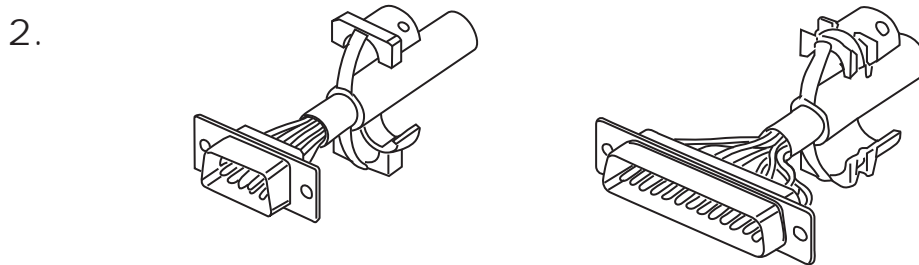
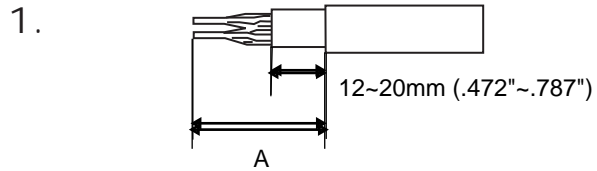

## Assembly Instructions DVZK Series

1.



2.

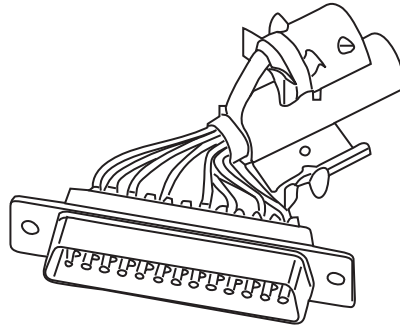

3.

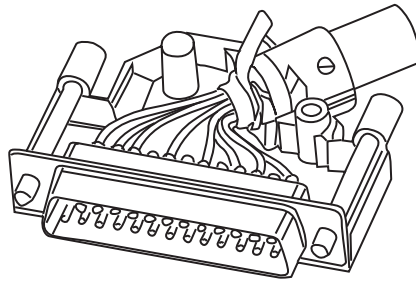

4.

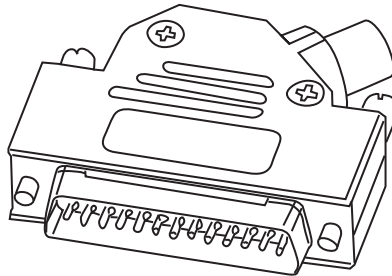

Type	A
L17DVZK9Kxx	30
L17DVZK15Kxx	(1.181")
L17DVZK25Kxx	45
L17DVZK37Kxx	(1.772")

Do not hesitate to contact us for further information



# Amphenol

### Amphenol IT & Communication Products

Block A3/A4, The 4th Industrial District of  
Industrial Headquarters, Dong Keng Road  
Gong Ming Town, Shen Zhen China  
Fax:+86(0)755 2754 9955

#### Technical Support

Tel:+86(0)755 2717 7945  
Info-dsub@amphenol.com.cn  
<http://www.dsubconnector.com>