

D'Sub Metallic Hoods

DTZK & DVZK series



MAIN CHARACTERISTICS

- **Material and plating:**
Zinc die-cast, nickel plated
- **Cable strainrelief:**
Steel fiber reinforced Polycarbonate UL94V-O
- **Temperature range:**
-40°C to 120°C
- **Cable diameter:**
3 to 13mm
- **Attenuation factor:**
> 40 dB between 30 MHz and 1 GHz
- **Approvals:**
VDE 0871 - FCC 20780 - 89 / 336 / EU

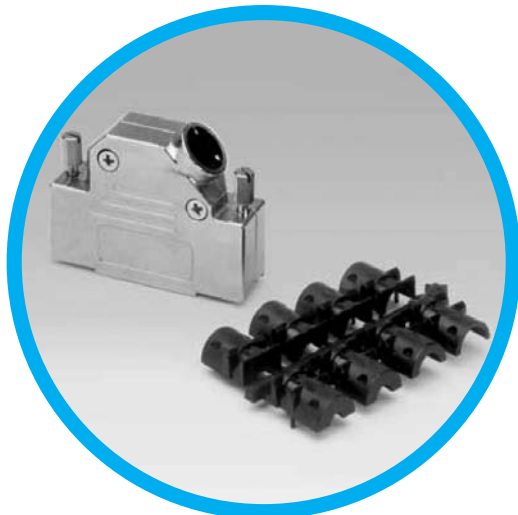

DESCRIPTION

Amphenol metallic hood series for D'Sub connectors offers protection from magnetic and radio interference to cable assemblies.

Easily assembled these hoods are suitable for all industrial and telecom applications.

*Shield
Your cable
assemblies!*

APPLICATIONS

- Industrial
- Military
- Telecom
- Any application requiring EMI/RFI protection



Amphenol

D'SUB ACCESSORIES / E23

DTZK Series



Part number	A	B
L17DTZK9Kxx	21 (.827")	38.3 (1.508")
L17DTZK15Kxx	39.5 (1.555")	40.5 (1.594")
L17DTZK25Kxx	54.4 (2.144")	47.3 (1.862")
L17DTZK37Kxx	70.9 (2.791")	52.2 (2.055")

xx = Blank for plastic knob and FM for metal knob

DVZK Series

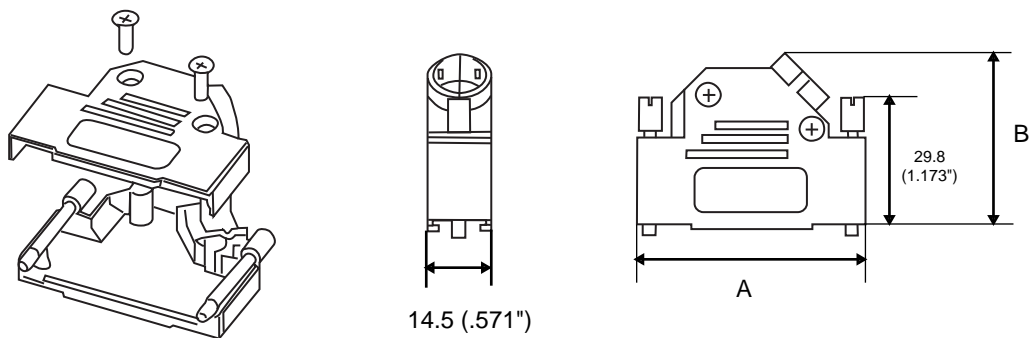

Part number	A	B
L17DVZK9Kxx	31 (1.220")	36,2 (1.425")
L17DVZK15Kxx	39,5 (1.555")	40,2 (1.583")
L17DVZK25Kxx	53,2 (2.094")	40,2 (1.583")
L17DVZK37Kxx	69,7 (2.744")	40,2 (1.583")



9 Size equipped with only one screw

xx = Blank for plastic knob and FM for metal knob

Assembly Instructions DTZK Series

Type	A
L17DTZK9Kxx	30 (1.181")
L17DTZK15Kxx	40 (1.575")
L17DTZK25Kxx	40 (1.575")
L17DTZK37Kxx	40 (1.575")

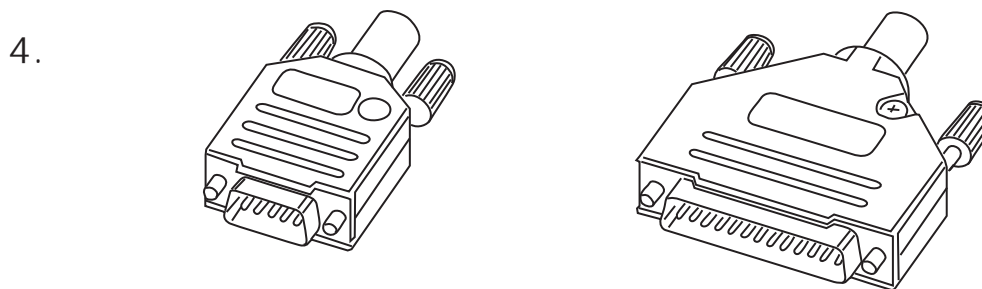
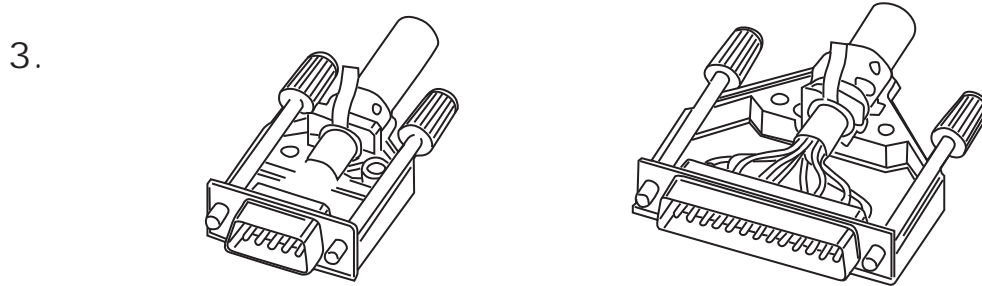
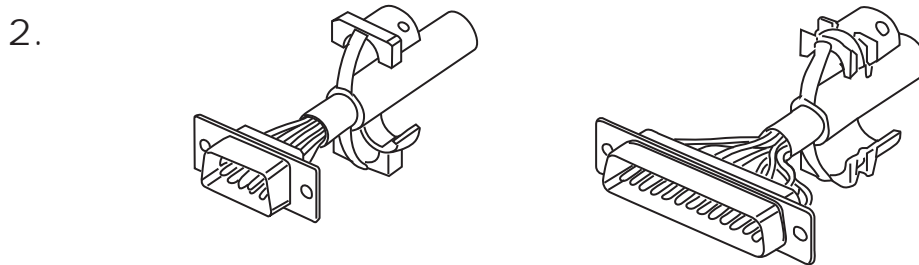
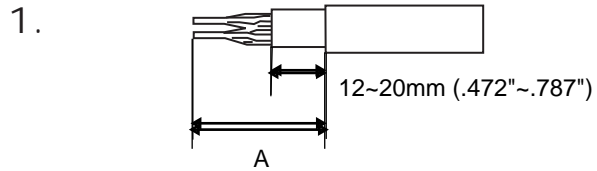

Assembly Instructions DVZK Series

1.



2.

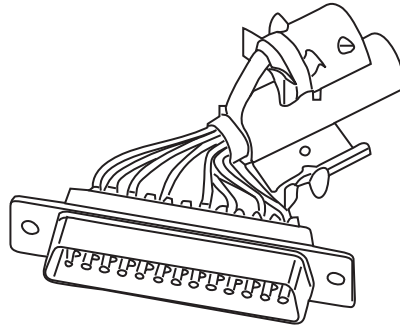

3.

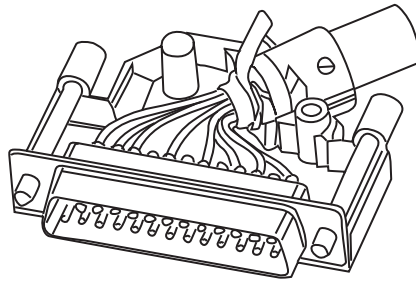

4.

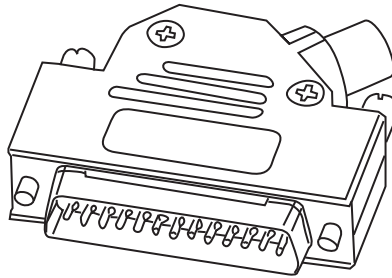

Type	A
L17DVZK9Kxx	30
L17DVZK15Kxx	(1.181")
L17DVZK25Kxx	45
L17DVZK37Kxx	(1.772")

Do not hesitate to contact us for further information



Amphenol

Amphenol IT & Communication Products

Block A3/A4, The 4th Industrial District of
Industrial Headquarters, Dong Keng Road
Gong Ming Town, Shen Zhen China
Fax:+86(0)755 2754 9955

Technical Support

Tel:+86(0)755 2717 7945
Info-dsub@amphenol.com.cn
<http://www.dsubconnector.com>