

Silver Line Series – Single & Multi-Output Linear

The Silver Line series follows the industry accepted footprint for open frame, linear power supplies. Standard screw terminal connections and optional covers are offered for safety considerations.





Applications

- Industrial Control Circuits and Components
- Instrumentation
- Drives
- CNC Machinery
- Equipment for food industry
- Microprocessor Circuits
- Analog Circuits
- Noise sensitive Circuitry and Sensors

Features

- Easy-to-install screw terminal connections
- Cover options
- Industry standard footprint
- Universal input and approvals (115/230 Vac)
- Low noise, extremely quiet DC output. For noise sensitive or analog circuitry.
- Fast transient response. Ideal for test applications.
- Built-in OVP on 5 V models and optional on 12, 15 and 24 V models
- Automatic resetting overload protection
- Short circuit protected
- Two year limited warranty

Certifications and Compliances

-  Recognized Component, ITE
 - UL 60950-1
-  Certified, ITE
 - CSA C22.2 CSA 60950-1
- 
 - IEC60950-1

Specifications

| Parameter | Condition | Limit |
|--|--|---|
| Input | | |
| Input Voltage | | 100/120/220/230/240 Vac Selectable |
| Input Frequency | | 47-63 Hz |
| Output | | |
| Line Regulation | for 10% change | 0.05% |
| Load Regulation | for 50% change | 0.05% |
| Ripple | | 3.0 mV maximum Peak-to-Peak |
| DC Output Adjustment Range | | ±5% Minimum |
| Overvoltage Protection | | All 5-Volt outputs include build-in OVP as standard (setting is 6.2 V ±0.4 V) OVP is optionally available on other types |
| Transient Response Time | at 50% Load Changes | 50 msec. |
| Overload Protection | | Automatic current limit foldback |
| Remote Sensing | Available to compensate for output voltage drop on selected models. | 0.5 Vdc |
| General | | |
| Operating Temperature Range | Derate to 40% at +70°C | 0 to +50°C |
| Storage Temperature Range | | -25°C to +85°C |
| Temperature Coefficient (Typical) | | 0.01% 0°C |
| Stability | After warm-up | ±.5% |
| EMI/RFI | Linear power supplies have inherently low conducted and radiate noise levels | For most system applications they will meet requirements of FCC Class B and VDE 0871 for Class B |
| Cover Option | Derate power by an additional 15% | |
| Cooling | Forced air. 20 CFM required for full rating Derate 30% without cooling | |

Specifications are typical. Load Regulation on outputs without Remote Sense, .1% typical.

SL Series Selection Table

| Catalog Number | Output 1 | Output 2 | Output 3 | Case |
|-------------------------------|--|---|---|------|
| SLS-05-030-1T | 5 V @ 3 A *2 | - | - | A |
| SLS-05-060-1T | 5 V @ 6 A *2 | - | - | B1 |
| SLS-05-090-1T | 5 V @ 9 A *2 | - | - | C |
| SLS-05-120-1T | 5 V @ 12 A *2 | - | - | I2 |
| SLS-12-017T1 | 12 V @ 1.7 A ² or 15 V @ 1.5 A | - | - | A |
| SLS-12-034T | 12 V @ 3.4 A ² | - | - | B1 |
| SLS-12-051T | 12 V @ 5.1 A ² | - | - | C |
| SLS-12-068T | 12 V @ 6.8 A ² | - | - | I2 |
| SLS-15-045T | 15 V @ 4.5 A ² | - | - | C |
| SLS-15-060T | 15 V @ 6 A ² | - | - | I2 |
| SLS-24-012T | 24 V @ 1.2 A v | - | - | A |
| SLS-24-024T | 24 V @ 2.4 A ² | - | - | B2 |
| SLS-24-036T | 24 V @ 3.6 A ² | - | - | C |
| SLS-24-048T | 24 V @ 4.8 A ² | - | - | I2 |
| SLS-24-072T | 24 V @ 7.2 A ² | - | - | K |
| SLS-24-120T | 24 V @ 12.0 A ² | - | - | L |
| SLD-12-1010-12T ¹ | 12 V @ 1 A or 15 V @ .8 A | -12 V @ 1 A or -15 V @ .8 | - | H1 |
| SLD-12-1818-12T ¹ | 12 V @ 1.8 A or 15 V @ 1.5 A | -12 V @ 1.8 A or -15 V @ 1.5 A | - | D |
| SLD-12-3434-12T | 12 V @ 3.4 A ² | -12 V @ 3.4 A ² | - | I3 |
| SLD-15-3030-15T | 15 V @ 3 A ² | -15 V @ 3 A ² | - | I3 |
| SLD-12-6034-05T | 5 V @ 6 A *2 | 12 V @ 3.4 A ² | - | I1 |
| SLD-12-3015-05T | 5 V @ 3 A *2 | 12 V @ 1.5 A | - | C1 |
| SLT 12-20404-12T ¹ | 5 V @ 2 A *2 | 12 V @ .4 A or 15 V @ .4 A | -12 V @ .4 A or -15 V @ .4 A | H2 |
| SLT 12-31010-12T1 | 5 V @ 3 A *2 | 12 V @ 1 A ² or 15 V @ .8 A | -12 V @ 1 A ² or -15 V @ .8 A | F |
| SLT 12-61818-12T1 | 5V @ 6A *2 | 12 V @ 1.8 A or 15 V @ 1.5 A | -12 V @ 1.8 A or -15 V @ 1.5 A | G2 |
| Over Voltage Protector (OVP) | | | | |
| SLO-12-000-1 | 6.2 V to 34 V Adjustable @ 8 A | For Cases B through K | | J1 |
| SLO-12-000-TB | 6.2 V to 34 V Adjustable @ 8 A | For Case A or Cases B through K (when used with a cover) | | J2 |

Notes:

* With Built-In OVP

- 12/15 Volt models are factory set for 12 Volt operation. 15 Volt operation is field adjustable.
2. With Remote Sense (R.S.)

Dimensions - inches (mm)



Case A



Case B

Cover Options

| Catalog Number | Description | Catalog Number | Description |
|----------------|------------------|----------------|------------------------------|
| SLCASA-CVR | Cover for Case A | SLCASI-CVR | Cover for Cases I1, I2, & I3 |
| SLCASB-CVR | Cover for Case B | SLCASK-CVR | Cover for Case K |
| SLCASC-CVR | Cover for Case C | SLCASL-CVR | Cover for Case L |

Note:

Covers are sold separately. When used, derate the power supply by 15% of its rated value.

Silver Line Dimensions (inches/mm)



Cases C and C1



Case D



Case F



Case G2



Cases H1 and H2

AC Input Jumper Connections

| For use at: | 100 Vac | 120 Vac | 220 Vac | 230/240 Vac |
|-------------|----------|----------|---------|-------------|
| Connect: | 1-3, 2-4 | 1-3, 2-4 | 2-3 | 2-3 |
| Apply AC: | 1 & 5 | 1 & 4 | 1 & 5 | 1 & 4 |

Silver Line Dimensions (inches/mm)

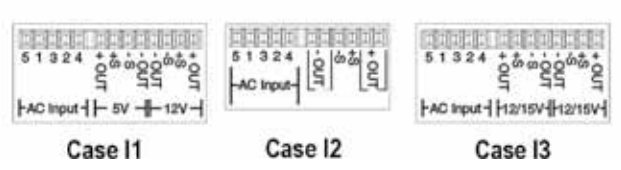
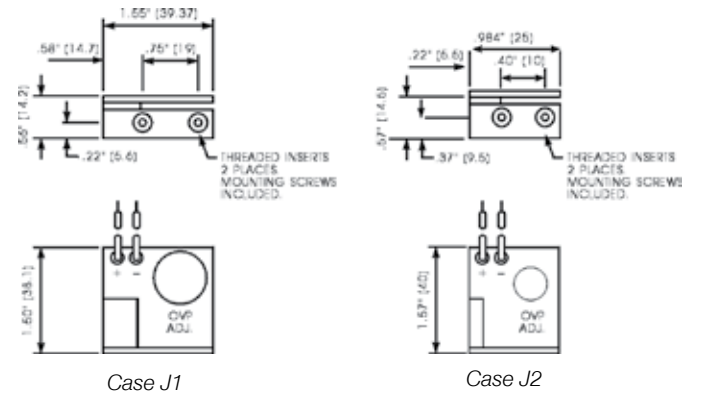

Cases I1, I2 and I3

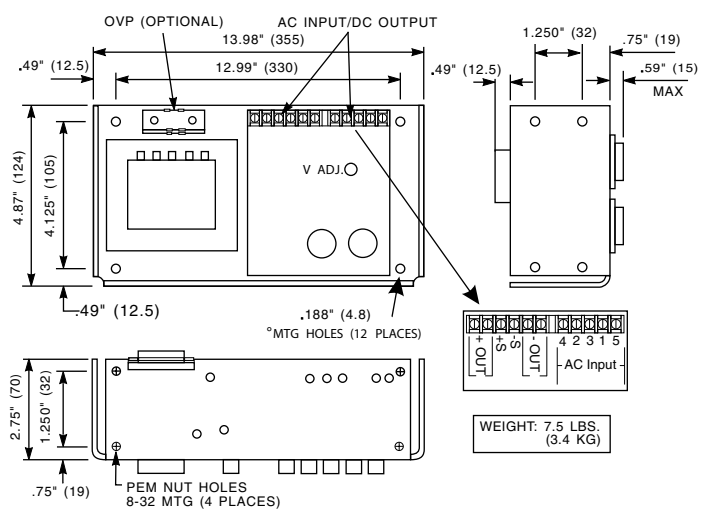

Case K

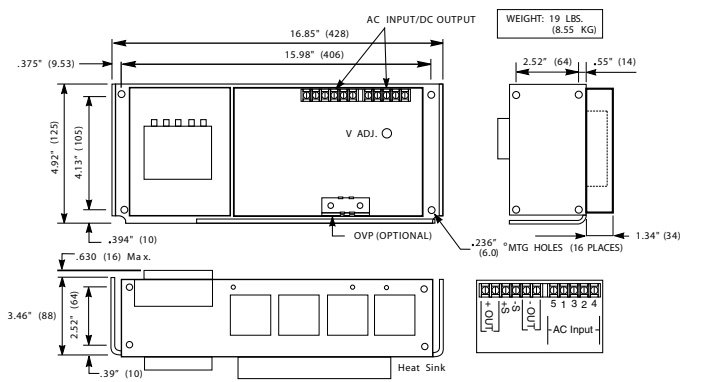

Case L

Notes:
 All dimensions in inches (mm). Dimensions may change and should not be used for construction purposes.
 Be sure to specify the complete part number when ordering. Orders may be placed with your local SolaHD distributor.