

High-side current sense amplifier

Datasheet - production data

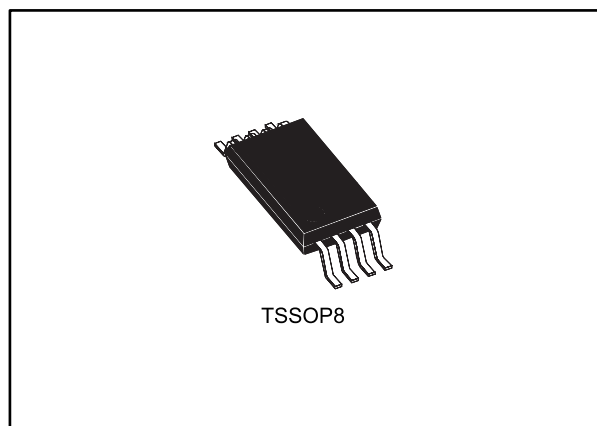

Related products

- See TSC103 for higher common-mode operating range (2.9 V to 70 V)

Applications

- Automotive current monitoring
- Notebook computers
- Server power supplies
- Telecom equipment
- Industrial SMPS
- Current sharing
- LED current measurement

Features

- Wide common-mode operating range independent of supply: 2.8 V to 30 V
- Wide common-mode survival range: -32 V to 60 V (reversed battery and load-dump conditions)
- Maximum input offset voltage:
 - ± 1.5 mV for $T_{amb} = 25$ °C
 - ± 2.3 mV for -40 °C $< T_{amb} < 125$ °C
- Maximum total output voltage error:
 - ± 1.5 % for $T_{amb} = 25$ °C
 - ± 2.5 % for -40 °C $< T_{amb} < 125$ °C
- Maximum variation over temperature:
 - $dV_{os}/dT = 8$ μ V/°C
 - $dV_{out}/dT = 100$ ppm/°C
- Low current consumption: I_{CC} max = 300 μ A
- -40 °C to 125 °C operating temperature range
- Internally fixed gain: 20 V/V, 50 V/V
- EMI filtering

Description

The TSC1021 measures a small differential voltage on a high-side shunt resistor and translates it into a ground-referenced output voltage.

The TSC1021 has been specifically designed for automotive conditions: load-dump protection up to 60 V, reverse-battery protection up to -32 V, ESD protection up to 4 kV and internal filtering for EMI performance.

Input common-mode and power supply voltages are independent: the common-mode voltage can range from 2.8 to 30 V in operating conditions and up to 60 V in absolute maximum ratings while the TSC1021 can be supplied by a 5 V independent supply line.

The TSC1021 is housed in a tiny TSSOP8 package and integrates a buffer that provides low impedance output to ease interfacing and avoid accuracy losses. The overall device current consumption is lower than 300 μ A.

Contents

| | | |
|----------|---|-----------|
| 1 | Application diagram | 3 |
| 2 | Pin configuration | 4 |
| 3 | Absolute maximum ratings and operating conditions | 5 |
| 4 | Electrical characteristics | 6 |
| 5 | Electrical characteristics curves: current sense amplifier | 8 |
| 6 | Parameter definitions | 11 |
| | 6.1 Common mode rejection ratio (CMR)..... | 11 |
| | 6.2 Supply voltage rejection ratio (SVR) | 11 |
| | 6.3 Gain (A_v) and input offset voltage (V_{os}) | 11 |
| | 6.4 Output voltage drift versus temperature | 11 |
| | 6.5 Output voltage accuracy | 12 |
| 7 | Package information | 13 |
| | 7.1 TSSOP8 package information..... | 14 |
| 8 | Ordering information..... | 15 |
| 9 | Revision history | 16 |

1 Application diagram

The TSC1021 high-side current-sense amplifier features a 2.8 V to 30 V input common-mode range that is independent of the supply voltage. The main advantage of this feature is that it allows high-side current sensing at voltages much greater than the supply voltage (V_{CC}).

Figure 1: Application schematic: high-line current sensing

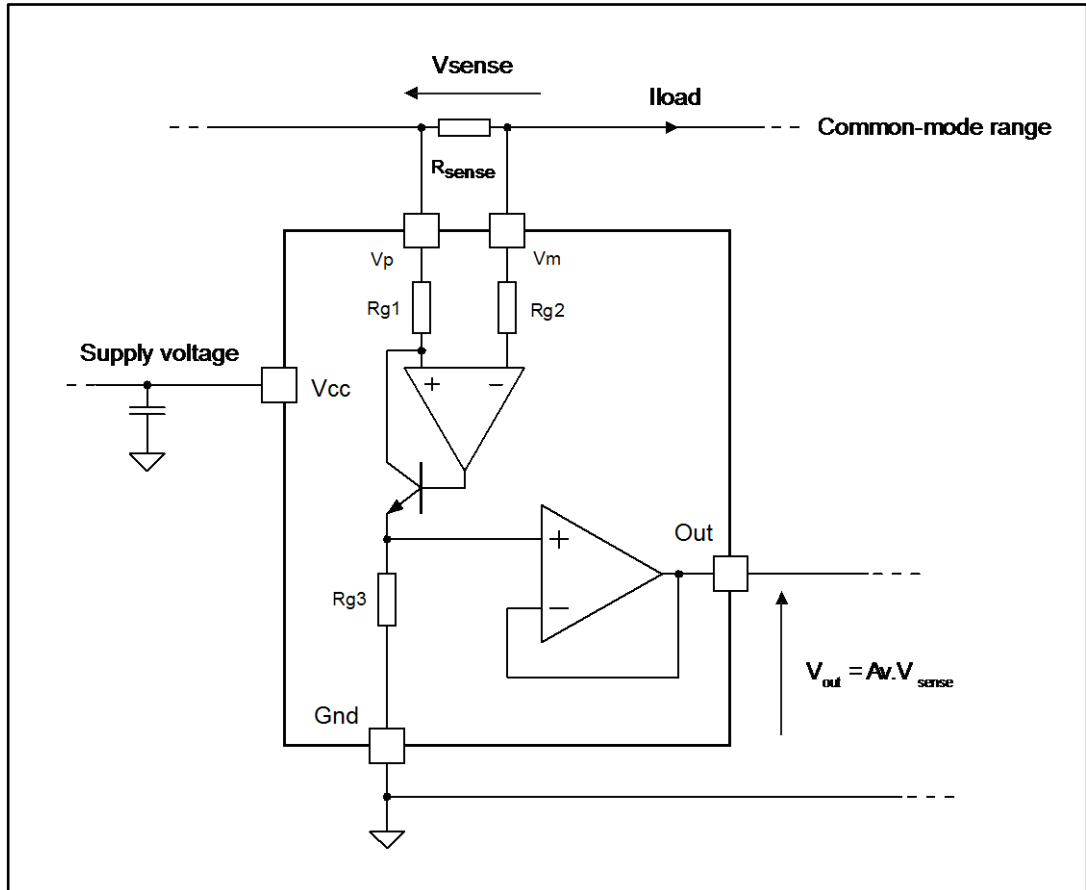

2 Pin configuration

Figure 2: Pin connections (top view)

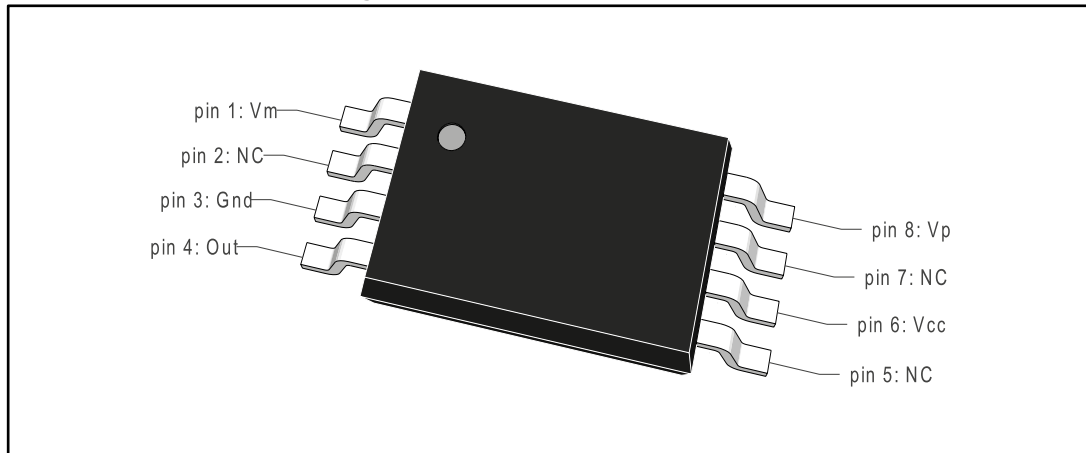

Table 1: "Pin description" describes the function of each pin. Their position is shown in the illustration on the cover page and in *Figure 2: "Pin connections (top view)"* above.

Table 1: Pin description

| Pin number | Symbol | Type | Function |
|------------|----------|---------------|--|
| 1 | V_m | Analog input | Connection for the external sense resistor. The measured current exits the shunt on the \bar{V}_m side. |
| 3 | Gnd | Power supply | Ground line |
| 4 | Out | Analog output | Buffered output of the current sensing amplifier |
| 6 | V_{CC} | Power supply | Positive power supply line |
| 8 | V_p | Analog input | Connection for the external sense resistor. The measured current enters the shunt on the \bar{V}_p side. |

3 Absolute maximum ratings and operating conditions

Table 2: Absolute maximum ratings

| Symbol | Parameter | Value | Unit |
|------------|---|------------|------|
| V_{id} | Input pins differential voltage ($V_p - V_m$) | ± 20 | V |
| V_i | Current sensing input pin voltages (V_p and V_m) ⁽¹⁾ | -32 to 60 | |
| V_1 | Voltage for Vcc, Out pins ⁽¹⁾ | -0.3 to 7 | |
| T_{stg} | Storage temperature | -65 to 150 | °C |
| T_j | Maximum junction temperature | 150 | |
| R_{thja} | TSSOP8 thermal resistance junction to ambient | 120 | °C/Ω |
| ESD | HBM: human body model for V_p and V_m pins ⁽²⁾ | 4 | kV |
| | HBM: human body model for all other pins ⁽²⁾ | 2 | |
| | MM: machine model ⁽³⁾ | 250 | V |
| | CDM: charged device model ⁽⁴⁾ | 1.5 | kV |

Notes:

⁽¹⁾Voltage values are measured with respect to the GND pin.

⁽²⁾Human body model: a 100 pF capacitor is charged to the specified voltage, then discharged through a 1.5 kΩ resistor between two pins of the device. This is done for all couples of connected pin combinations while the other pins are floating.

⁽³⁾Machine model: a 200 pF capacitor is charged to the specified voltage, then discharged directly between two pins of the device with no external series resistor (internal resistor < 5 Ω). This is done for all couples of connected pin combinations while the other pins are floating.

⁽⁴⁾Charged device model: all pins and package are charged together to the specified voltage and then discharged directly to ground.

Table 3: Operating conditions

| Symbol | Parameter | Value | Unit |
|------------|--|------------|------|
| V_{CC} | DC supply voltage from T_{min} to T_{max} | 3.5 to 5.5 | V |
| T_{oper} | Operational temperature range (T_{min} to T_{max}) | -40 to 125 | °C |
| V_{icm} | Common-mode voltage range (V_m and V_p pin voltage) | 2.8 to 30 | V |

4 Electrical characteristics

The electrical characteristics given in the following tables are measured under the following test conditions unless otherwise specified: $T_{amb} = 25\text{ °C}$, $V_{CC} = 5\text{ V}$, $V_{sense} = V_p - V_m = 50\text{ mV}$, $V_m = 12\text{ V}$, no load on Out, all gain configurations.

Table 4: Supply

| Symbol | Parameter | Test conditions | Min. | Typ. | Max. | Unit |
|-----------|----------------------|--|------|------|------|---------------|
| I_{CC} | Total supply current | $V_{sense} = 0\text{ V}$, $-40\text{ °C} < T_{amb} < 125\text{ °C}$ | — | — | 300 | μA |
| I_{CC1} | Total supply current | $V_{sense} = 50\text{ mV}$, $-40\text{ °C} < T_{amb} < 125\text{ °C}$ | | | 450 | |

Table 5: Electrical performances

| Symbol | Parameter | Test conditions | Min. | Typ. | Max. | Unit |
|---------------------------------|--|---|------|-----------|-----------|-------------------------|
| DC CMR | DC common-mode rejection, variation of V_{out} versus V_m referred to input ⁽¹⁾ | $2.8\text{ V} < V_m < 30\text{ V}$, $-40\text{ °C} < T_{amb} < 125\text{ °C}$ | 90 | 105 | | dB |
| AC CMR | AC common mode rejection, variation of V_{out} versus V_m referred to input (peak-to-peak voltage variation) | $2.8\text{ V} < V_m < 30\text{ V}$, DC to 1 kHz sine wave | | 75 | | |
| SVR | Supply voltage rejection, variation of V_{out} versus V_{CC} ⁽¹⁾ | $3.5\text{ V} < V_{CC} < 5.5\text{ V}$, $-40\text{ °C} < T_{amb} < 125\text{ °C}$ | 80 | 95 | | |
| V_{os} | Input offset voltage ⁽¹⁾ | $2.8\text{ V} < V_m < 30\text{ V}$, $T_{amb} = 25\text{ °C}$ | | | ± 1.5 | mV |
| | | $2.8\text{ V} < V_m < 30\text{ V}$, $-40\text{ °C} < T_{amb} < 125\text{ °C}$ | | | ± 2.3 | |
| dV_{os}/dT | Input offset drift vs. T | $-40\text{ °C} < T_{amb} < 125\text{ °C}$ | | | 8 | $\mu\text{V}/\text{°C}$ |
| dV_{out}/dT | Output voltage drift vs. T | $-40\text{ °C} < T_{amb} < 125\text{ °C}$ | | | 100 | ppm/ °C |
| I_{lk} | Input leakage current | $V_{CC} = 0\text{ V}$, $-40\text{ °C} < T_{amb} < 125\text{ °C}$ | | | 1 | μA |
| I_{ib} | Input bias current | $V_{sense} = 0\text{ V}$, $-40\text{ °C} < T_{amb} < 125\text{ °C}$ | | | 7 | |
| A_v | Gain, (variation of V_{out} versus V_{sense}) | TSC1021A | | 20 | | V/V |
| | | TSC1021B | | 50 | | |
| ΔV_{out} | Total output voltage accuracy ⁽²⁾ | $V_{sense} = 50\text{ mV}$, $T_{amb} = 25\text{ °C}$ | | | ± 1.5 | % |
| | | $V_{sense} = 50\text{ mV}$, $T_{min} < T_{amb} < T_{max}$ | | | ± 2.5 | |
| | | $V_{sense} = 100\text{ mV}$, $T_{amb} = 25\text{ °C}$ | | | ± 1.5 | |
| | | $V_{sense} = 100\text{ mV}$, $T_{min} < T_{amb} < T_{max}$ | | | ± 2.5 | |
| | | $V_{sense} = 20\text{ mV}$, $T_{amb} = 25\text{ °C}$ | | | ± 7 | |
| | | $V_{sense} = 20\text{ mV}$, $T_{min} < T_{amb} < T_{max}$ | | | ± 9 | |
| | | $V_{sense} = 10\text{ mV}$, $T_{amb} = 25\text{ °C}$ | | | ± 12 | |
| | | $V_{sense} = 10\text{ mV}$, $T_{min} < T_{amb} < T_{max}$ | | | ± 15 | |
| $\Delta V_{out}/\Delta I_{out}$ | Output stage load regulation | $-5\text{ mA} < I_{out} < 5\text{ mA}$, I_{out} sink or source current | | ± 0.4 | ± 2 | mV/mA |

| Symbol | Parameter | Test conditions | Min. | Typ. | Max. | Unit |
|----------|--|--|------|------|------|------|
| V_{oh} | Out high level saturation voltage, $V_{oh}=V_{cc}-V_{out}$ | $V_{sense} = 1\text{ V}$, $I_{out} = 1\text{ mA}$, $T_{amb} = 25\text{ °C}$ | | 90 | 135 | mV |
| | | $V_{sense} = 1\text{ V}$, $I_{out} = 1\text{ mA}$, $-40\text{ °C} < T_{amb} < 125\text{ °C}$ | | | 185 | |
| V_{ol} | Out low level saturation voltage | $V_{sense} = -1\text{ V}$, $I_{out} = 1\text{ mA}$, $T_{amb} = 25\text{ °C}$ | | 80 | 125 | |
| | | $V_{sense} = -1\text{ V}$, $I_{out} = 1\text{ mA}$, $-40\text{ °C} < T_{amb} < 125\text{ °C}$ | | | 165 | |

Notes:

(1) See [Section 6: "Parameter definitions"](#).

(2) Output voltage accuracy is the difference with the expected theoretical output voltage $V_{out-th} = AV \times V_{sense}$. See [Section 6: "Parameter definitions"](#) for a more detailed definition.

Table 6: Dynamic performances

| Symbol | Parameter | Test conditions | Min. | Typ. | Max. | Unit |
|--------|---------------------------------------|--|------|------|------|------------------------------|
| t_s | V_{out} settling to 1 % final value | $V_{sense} = 10\text{ mV to }100\text{ mV}$, $C_{load} = 47\text{ pF}$ | | 7 | | μs |
| SR | Slew rate | $V_{sense} = 10\text{ mV to }100\text{ mV}$ | 0.3 | 0.45 | | $\text{V}/\mu\text{s}$ |
| BW | 3 dB bandwidth | $C_{load} = 47\text{ pF}$ | | 800 | | kHz |
| e_N | Equivalent input noise voltage | $f = 1\text{ kHz}$ | | 50 | | $\text{nV}/\sqrt{\text{Hz}}$ |

5 Electrical characteristics curves: current sense amplifier

Unless otherwise specified, the test conditions for the following curves are:

- $T_{amb} = 25\text{ }^{\circ}\text{C}$, $V_{CC} = 5\text{ V}$, $V_{sense} = V_p - V_m = 50\text{ mV}$, $V_m = 12\text{ V}$.
- No load on the Out pin.

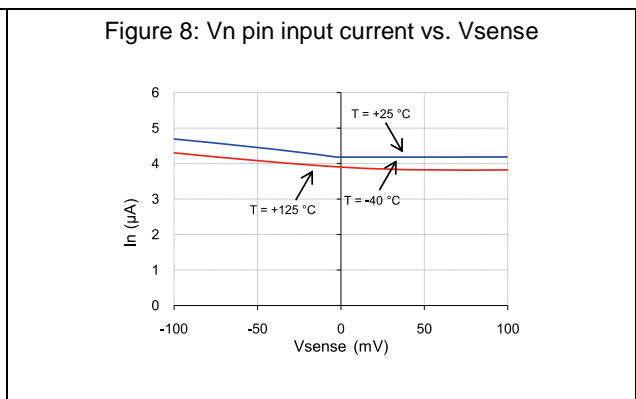
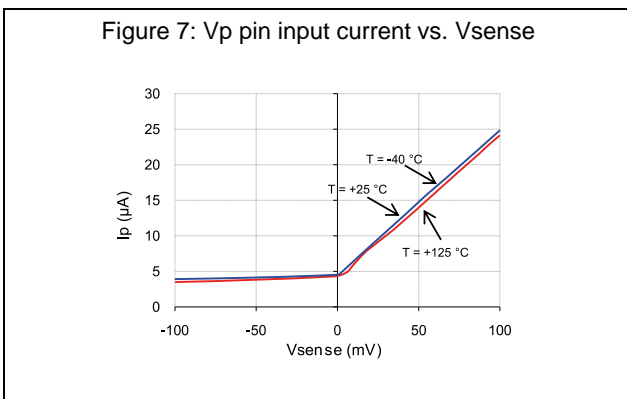
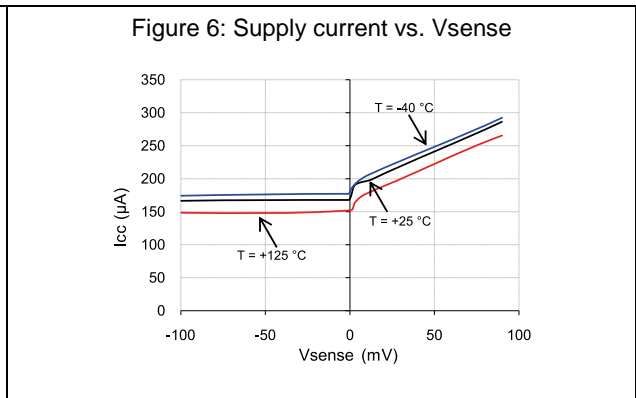
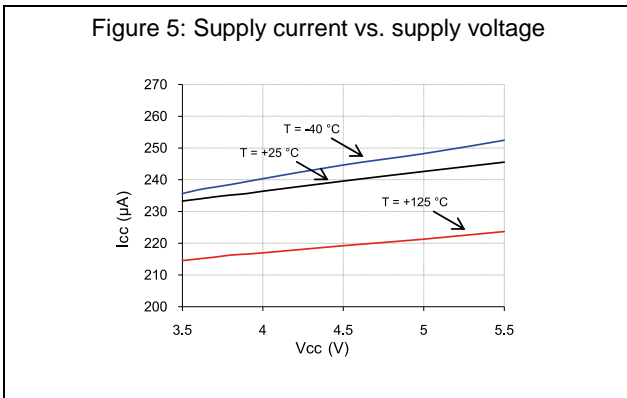
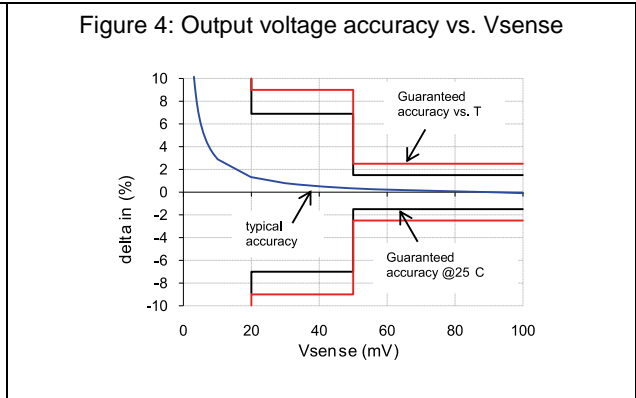
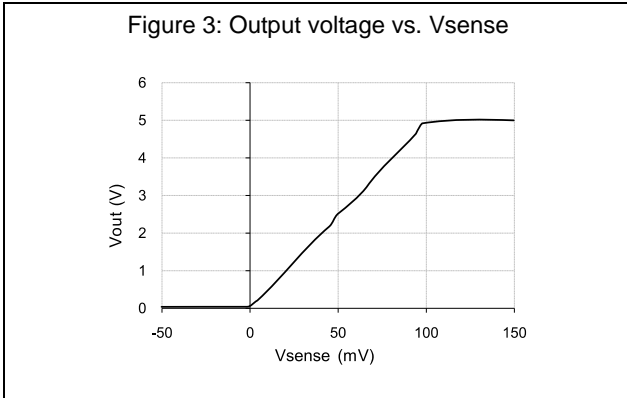

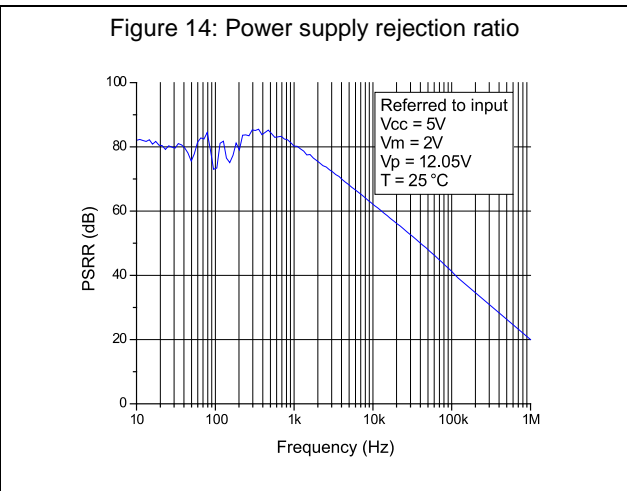
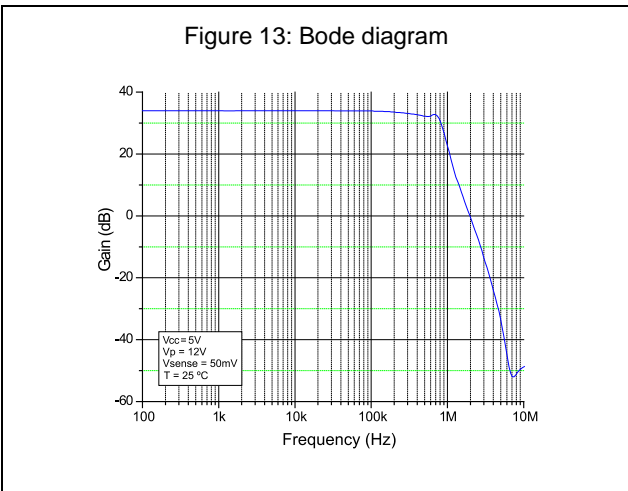
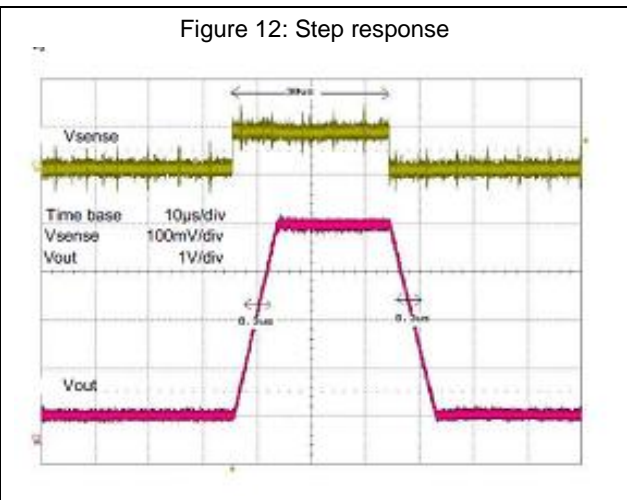
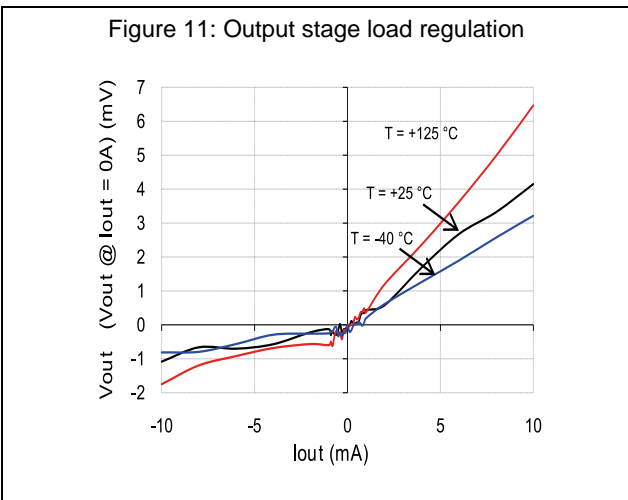
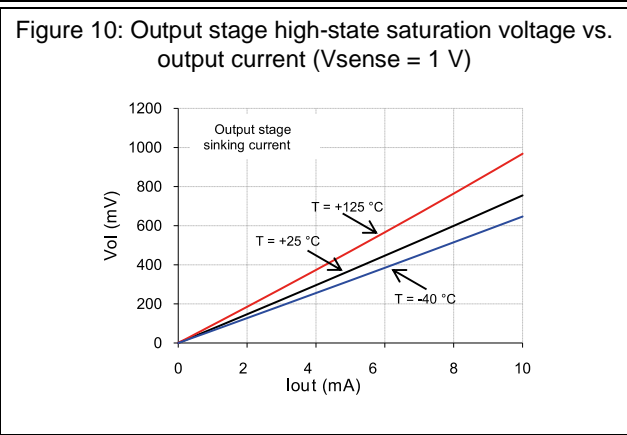
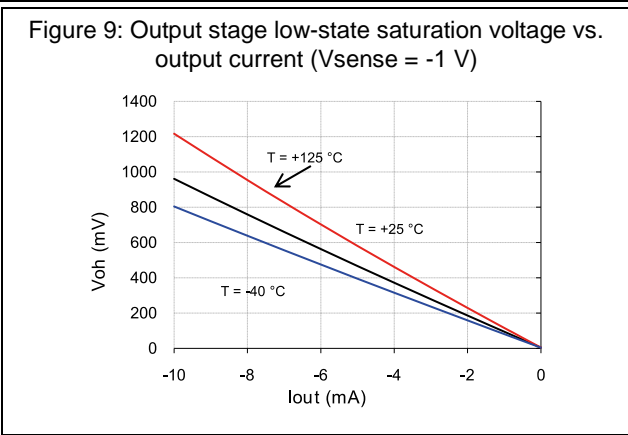
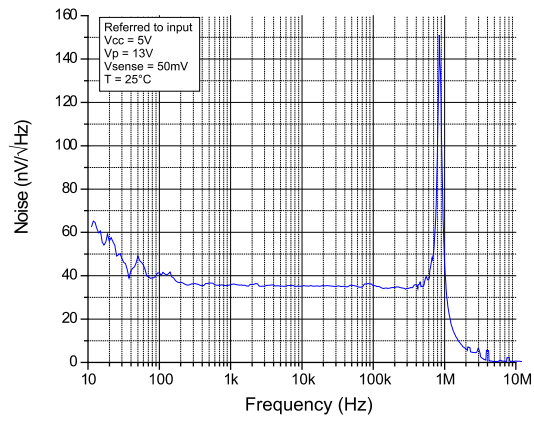

Figure 15: Noise level



6 Parameter definitions

6.1 Common mode rejection ratio (CMR)

The common-mode rejection ratio (CMR) measures the ability of the current-sensing amplifier to reject any DC voltage applied on both inputs V_p and V_m . The CMR is referred back to the input so that its effect can be compared with the applied differential signal. The CMR is defined by the formula:

$$\text{CMR} = -20 \cdot \log \frac{\Delta V_{\text{out}}}{\Delta V_{\text{icm}} \cdot A_v}$$

6.2 Supply voltage rejection ratio (SVR)

The supply-voltage rejection ratio (SVR) measures the ability of the current-sensing amplifier to reject any variation of the supply voltage V_{CC} . The SVR is referred back to the input so that its effect can be compared with the applied differential signal. The SVR is defined by the formula:

$$\text{SVR} = -20 \cdot \log \frac{\Delta V_{\text{out}}}{\Delta V_{\text{cc}} \cdot A_v}$$

6.3 Gain (A_v) and input offset voltage (V_{os})

The input offset voltage is defined as the intersection between the linear regression of the V_{out} vs. the V_{sense} curve with the X-axis. If $V_{\text{out}1}$ is the output voltage with $V_{\text{sense}} = V_{\text{sense}1} = 50$ mV, and $V_{\text{out}2}$ is the output voltage with $V_{\text{sense}} = V_{\text{sense}2} = 5$ mV, then V_{os} can be calculated with the following formula.

$$V_{os} = V_{\text{sense}1} - \frac{V_{\text{sense}1} - V_{\text{sense}2}}{V_{\text{out}1} - V_{\text{out}2}} \cdot V_{\text{out}1}$$

6.4 Output voltage drift versus temperature

The output voltage drift versus temperature is defined as the maximum variation of V_{out} with respect to its value at 25 °C, over the temperature range. It is calculated as follows:

$$\frac{\Delta V_{\text{out}}}{\Delta T} = \max \left| \frac{V_{\text{out}}(T_{\text{amb}}) - V_{\text{out}}(25^\circ \text{C})}{T_{\text{amb}} - 25^\circ \text{C}} \right|$$

with $T_{\text{min}} < T_{\text{amb}} < T_{\text{max}}$.

6.5 Output voltage accuracy

The output voltage accuracy is the difference between the actual output voltage and the theoretical output voltage. Ideally, the current sensing output voltage should be equal to the input differential voltage multiplied by the theoretical gain, as in the following formula.

$$V_{\text{out-th}} = A_v \cdot V_{\text{sense}}$$

The actual value is very slightly different, mainly due to the effects of:

- the input offset voltage V_{os}
- the non-linearity
- the voltage saturation of V_{OL} and V_{OH}

The output voltage accuracy, expressed as a percentage, can be calculated with the following formula.

$$\Delta V_{\text{out}} = \frac{\text{abs}(V_{\text{out}} - (A_v \cdot V_{\text{sense}}))}{A_v \cdot V_{\text{sense}}}$$

With $A_v = 20 \text{ V/V}$ for TSC1021A and $A_v = 50 \text{ V/V}$ for TSC1021B.

7 Package information

In order to meet environmental requirements, ST offers these devices in different grades of ECOPACK[®] packages, depending on their level of environmental compliance. ECOPACK[®] specifications, grade definitions and product status are available at: www.st.com. ECOPACK[®] is an ST trademark.

7.1 TSSOP8 package information

Figure 16: TSSOP8 package outline

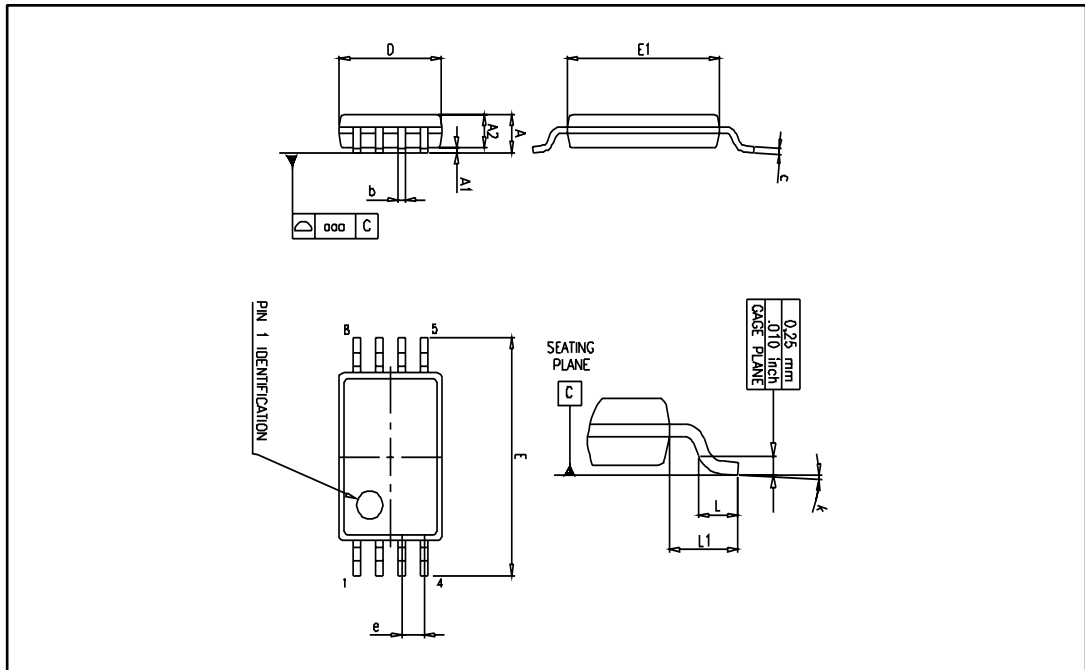

Table 7: TSSOP8 mechanical data

| Ref. | Dimensions | | | | | |
|------|-------------|------|------|--------|--------|-------|
| | Millimeters | | | Inches | | |
| | Min. | Typ. | Max. | Min. | Typ. | Max. |
| A | | | 1.2 | | | 0.047 |
| A1 | 0.05 | | 0.15 | 0.002 | | 0.006 |
| A2 | 0.80 | 1.00 | 1.05 | 0.031 | 0.039 | 0.041 |
| b | 0.19 | | 0.30 | 0.007 | | 0.012 |
| c | 0.09 | | 0.20 | 0.004 | | 0.008 |
| D | 2.90 | 3.00 | 3.10 | 0.114 | 0.118 | 0.122 |
| E | 6.20 | 6.40 | 6.60 | 0.244 | 0.252 | 0.260 |
| E1 | 4.30 | 4.40 | 4.50 | 0.169 | 0.173 | 0.177 |
| e | | 0.65 | | | 0.0256 | |
| k | 0° | | 8° | 0° | | 8° |
| L | 0.45 | 0.60 | 0.75 | 0.018 | 0.024 | 0.030 |
| L1 | | 1 | | | 0.039 | |
| aaa | | 0.1 | | | 0.004 | |

8 Ordering information

Table 8: Order codes

| Part number | Temperature range | Package | Packaging | Marking | Gain |
|--------------|---|---------|---------------|---------|------|
| TSC1021AIPT | -40 °C to 125 °C | TSSOP8 | Tape and reel | O21AI | 20 |
| TSC1021BIPT | | | | O21BI | 50 |
| TSC1021AIYPT | -40 °C to 125 °C automotive grade ⁽¹⁾ | | | O21AY | 20 |
| TSC1021BIYPT | | | | O21BY | 50 |

Notes:

⁽¹⁾Qualified and characterized according to AEC Q100 and Q003 or equivalent, advanced screening according to AEC Q001 & Q002 or equivalent.

9 Revision history

Table 9: Document revision history

| Date | Revision | Changes |
|-------------|----------|---|
| 23-Sep-2010 | 1 | Initial release |
| 26-Feb-2014 | 2 | Added Section 5: "Electrical characteristics curves: current sense amplifier". Updated footnote 1 of Table 8: "Order codes" |
| 18-Aug-2014 | 3 | Added Related products Replaced Figure 2: Pin connections (top view) Table 5: Electrical performances: corrected several erroneous symbols. Table 8: Order codes: updated "Marking", updated footnote 1 |
| 06-Nov-2015 | 4 | Table 2: "Absolute maximum ratings" : updated second "HBM" parameter. Table 5: "Electrical performances" : updated unit of V_{os} parameter from μV to mV. Table 7: "TSSOP8 mechanical data" : updated parameter "aaa" |

IMPORTANT NOTICE – PLEASE READ CAREFULLY

STMicroelectronics NV and its subsidiaries ("ST") reserve the right to make changes, corrections, enhancements, modifications, and improvements to ST products and/or to this document at any time without notice. Purchasers should obtain the latest relevant information on ST products before placing orders. ST products are sold pursuant to ST's terms and conditions of sale in place at the time of order acknowledgement.

Purchasers are solely responsible for the choice, selection, and use of ST products and ST assumes no liability for application assistance or the design of Purchasers' products.

No license, express or implied, to any intellectual property right is granted by ST herein.

Resale of ST products with provisions different from the information set forth herein shall void any warranty granted by ST for such product.

ST and the ST logo are trademarks of ST. All other product or service names are the property of their respective owners.

Information in this document supersedes and replaces information previously supplied in any prior versions of this document.

© 2015 STMicroelectronics – All rights reserved