

3D MOTION click

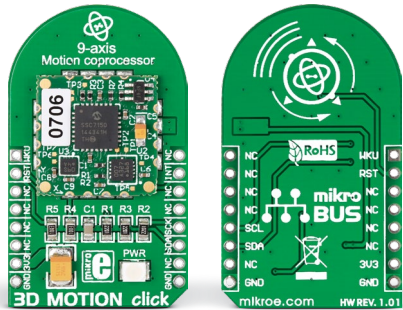

1. Introduction

3D Motion click carries Microchip's **MM7150** 9-axis sensor fusion motion module. It's a complete self contained solution comprising a 3-axis accelerometer, a gyroscope, a magnetometer, and a **SSC7150** motion coprocessor. The board communicates with the target MCU through the mikroBUS™ I²C interface [SCL, SDA — with support to speeds up to 400kHz]; WAKE and RESET pins are also used [in place of default mikroBUS™ AN and RST respectively], as well as an interrupt pin (INT). It's designed to use a 3.3V power supply.

2. Soldering the headers

Before using your click board™, make sure to solder 1x8 male headers to both left and right side of the board. Two 1x8 male headers are included with the board in the package.

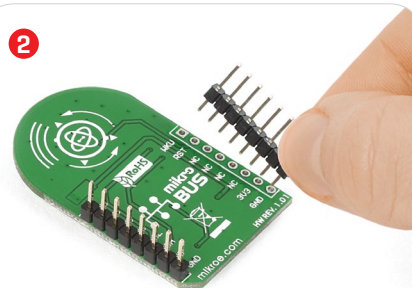
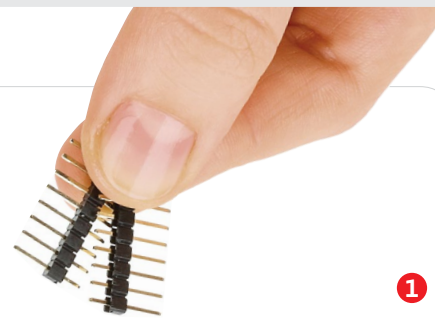

Turn the board upside down so that the bottom side is facing you upwards. Place shorter pins of the header into the appropriate soldering pads.

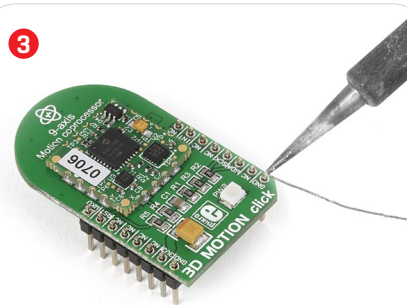

Turn the board upward again. Make sure to align the headers so that they are perpendicular to the board, then solder the pins carefully.

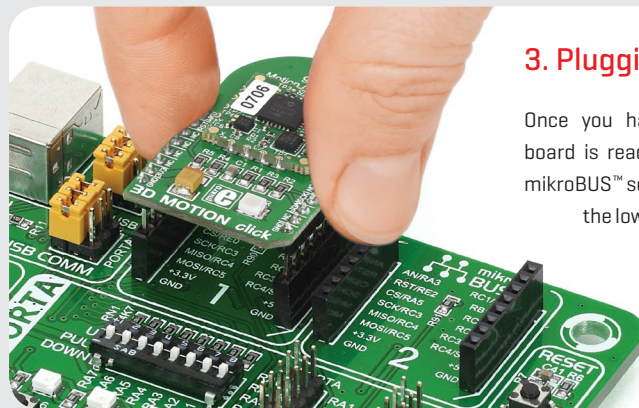

3. Plugging the board in

Once you have soldered the headers your board is ready to be placed into the desired mikroBUS™ socket. Make sure to align the cut in the lower-right part of the board with the markings on the silkscreen at the mikroBUS™ socket. If all the pins are aligned correctly, push the board all the way into the socket.

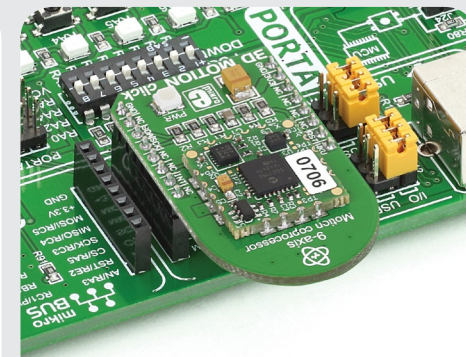

4. Essential features

The biggest asset of 3D Motion click and the MM7150 module is the integrated motion coprocessor. This chip takes raw data from individual sensors [accelerometer, magnetometer, and gyroscope] and then uses preprogrammed sensor fusion algorithms to filter, compensate and combine the data. The fusion firmware suppress magnetic distortion, cancels gyroscope drift, and performs in-use background calibrations of all sensors. In the end you get easy access to reliable and accurate positioning and orientation information.

click
BOARD™
www.mikroe.com



3D MOTION click manual
ver 1.01



5. Schematic

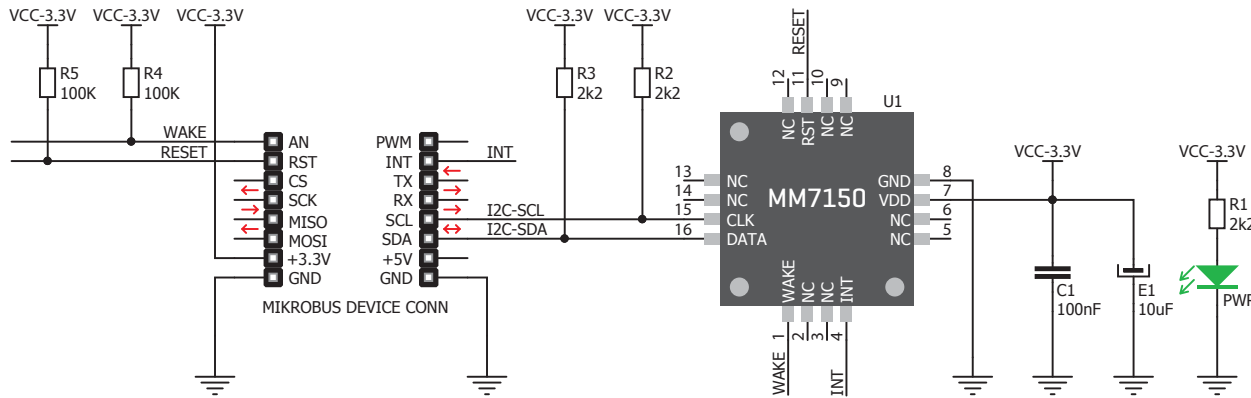

6. Dimensions

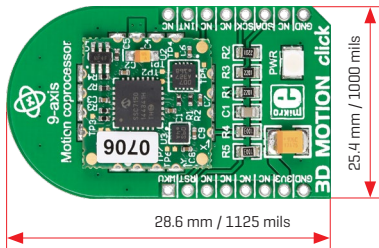

	mm	mils
LENGTH	42.9	1690
WIDTH	25.4	1000
HEIGHT*	4.65	183

* without headers

7. Sensors onboard



The MM7150 motion module consists of three chips: Bosch BMC150 accelerometer,

Bosch BMG160 Gyroscope, and Microchip's SSC7150 motion coprocessor.

8. Code examples

Once you have done all the necessary preparations, it's time to get your click board™ up and running. We have provided examples for mikroC™, mikroBasic™ and mikroPascal™ compilers on our **Libstock** website. Just download them and you are ready to start.



9. Support

MikroElektronika offers **free tech support** [www.mikroe.com/support] until the end of the product's lifetime, so if something goes wrong, we're ready and willing to help!



10. Disclaimer

MikroElektronika assumes no responsibility or liability for any errors or inaccuracies that may appear in the present document. Specification and information contained in the present schematic are subject to change at any time without notice.

Copyright © 2015 MikroElektronika.
All rights reserved.