

## DIO236XL

### Ultra Low Vos, Low Power Amplifier

#### Features

- Ultra low  $V_{OS}$ : DIO2361LA/2LA:  $10\mu V$ (Max)  
DIO2361LB/2LB:  $20\mu V$ (Max)  
DIO2361L/2L:  $40\mu V$ (Max)  
DIO2361LM/2LM:  $65\mu V$ (Max)
- Low Power:  $7.0\mu A$ (typ.)
- Unity Gain Stable
- Gain Bandwidth Product:  $110kHz$ (typ.)
- Wide supply range:  $1.8V$  to  $5.5V$
- Available in SOT23-5, SC70-5, SOIC-8, MSOP-8, DFN2\*2-8 and DFN3\*3-8 packages
- Temperature Range:
  - Industrial:  $-40^{\circ}C$  to  $85^{\circ}C$
  - Extended:  $-40^{\circ}C$  to  $125^{\circ}C$

#### Descriptions

DIO236xL is a family of ultra low  $V_{OS}$  operational amplifier, with rail-to-rail CMOS input/output and single/dual channels selectable. DIO236xL family has a gain-bandwidth product of  $110kHz$ (typ.), wide operating supply voltage from  $1.8V$  to  $5.5V$  and broad output voltage swing.

DIO236xL consumes ultra low power, with each channel  $7.0\mu A$ (typ.) of bias current, which makes DIO236xL be ideal for battery powered device, temperature-sense device, etc.

#### Typical Applications

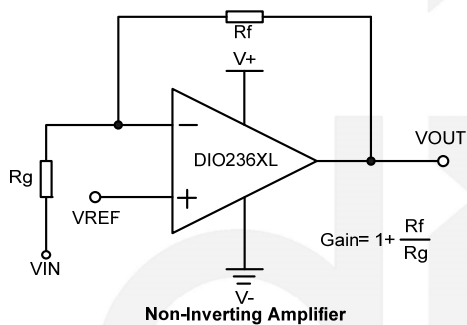

#### Applications

- Portable Equipment
- Active Filters
- Data Acquisition
- Test Equipment
- Broadband Communication
- Process Control
- Audio and Video Processing



# DIO236XL

Ultra Low Vos, Low Power Amplifier

## Ordering Information

Order Part Number	Top Marking		T <sub>A</sub>	Package	
DIO2361LASC5	W36L	Green or RoHS	-40 to 125°C	SC70-5	Tape & Reel, 3000
DIO2361LAST5	W36L	Green or RoHS	-40 to 125°C	SOT23-5	Tape & Reel, 3000
DIO2361LASO8	D2361L	Green or RoHS	-40 to 125°C	SOIC-8	Tape & Reel, 2500
DIO2361LAMP8	D2361L	Green or RoHS	-40 to 125°C	MSOP-8	Tape & Reel, 3000
DIO2361LBSC5	W36L	Green or RoHS	-40 to 125°C	SC70-5	Tape & Reel, 3000
DIO2361LBST5	W36L	Green or RoHS	-40 to 125°C	SOT23-5	Tape & Reel, 3000
DIO2361LBSO8	D2361L	Green or RoHS	-40 to 125°C	SOIC-8	Tape & Reel, 2500
DIO2361LBMP8	D2361L	Green or RoHS	-40 to 125°C	MSOP-8	Tape & Reel, 3000
DIO2361LSC5	W36L	Green or RoHS	-40 to 125°C	SC70-5	Tape & Reel, 3000
DIO2361LST5	W36L	Green or RoHS	-40 to 125°C	SOT23-5	Tape & Reel, 3000
DIO2361LSO8	D2361L	Green or RoHS	-40 to 125°C	SOIC-8	Tape & Reel, 2500
DIO2361LMP8	D2361L	Green or RoHS	-40 to 125°C	MSOP-8	Tape & Reel, 3000
DIO2361LMSC5	W36L	Green or RoHS	-40 to 125°C	SC70-5	Tape & Reel, 3000
DIO2361LMST5	W36L	Green or RoHS	-40 to 125°C	SOT23-5	Tape & Reel, 3000
DIO2361LMSO8	D2361L	Green or RoHS	-40 to 125°C	SOIC-8	Tape & Reel, 2500
DIO2361LMMP8	D2361L	Green or RoHS	-40 to 125°C	MSOP-8	Tape & Reel, 3000
DIO2362LACN8	236L	Green or RoHS	-40 to 125°C	DFN2*2-8	Tape & Reel, 3000
DIO2362LACD8	2362L	Green or RoHS	-40 to 125°C	DFN3*3-8	Tape & Reel, 5000
DIO2362LASO8	D2362L	Green or RoHS	-40 to 125°C	SOIC-8	Tape & Reel, 2500
DIO2362LAMP8	D2362L	Green or RoHS	-40 to 125°C	MSOP-8	Tape & Reel, 3000
DIO2362LBCN8	236L	Green or RoHS	-40 to 125°C	DFN2*2-8	Tape & Reel, 3000
DIO2362LBCD8	2362L	Green or RoHS	-40 to 125°C	DFN3*3-8	Tape & Reel, 5000
DIO2362LBSO8	D2362L	Green or RoHS	-40 to 125°C	SOIC-8	Tape & Reel, 2500
DIO2362LBMP8	D2362L	Green or RoHS	-40 to 125°C	MSOP-8	Tape & Reel, 3000
DIO2362LCN8	236L	Green or RoHS	-40 to 125°C	DFN2*2-8	Tape & Reel, 3000
DIO2362LCD8	2362L	Green or RoHS	-40 to 125°C	DFN3*3-8	Tape & Reel, 5000
DIO2362LSO8	D2362L	Green or RoHS	-40 to 125°C	SOIC-8	Tape & Reel, 2500
DIO2362LMP8	D2362L	Green or RoHS	-40 to 125°C	MSOP-8	Tape & Reel, 3000
DIO2362LMCN8	236L	Green or RoHS	-40 to 125°C	DFN2*2-8	Tape & Reel, 3000
DIO2362LMCD8	2362L	Green or RoHS	-40 to 125°C	DFN3*3-8	Tape & Reel, 5000
DIO2362LMSO8	D2362L	Green or RoHS	-40 to 125°C	SOIC-8	Tape & Reel, 2500
DIO2362LMMP8	D2362L	Green or RoHS	-40 to 125°C	MSOP-8	Tape & Reel, 3000

## Ordering Information Complimentary Note

Ordering Code = Part No. + Package Code

DIO2361LA/2LA  
DIO2361LB/2LB  
DIO2361L/2L  
DIO2361LM/2LM

SC5: stands for SC70-5  
ST5: stands for SOT23-5  
SO8: stands for SOIC-8  
MP8: stands for MSOP-8  
CN8: stands for DFN2\*2-8  
CD8: stands for DFN3\*3-8

## Pin Assignments

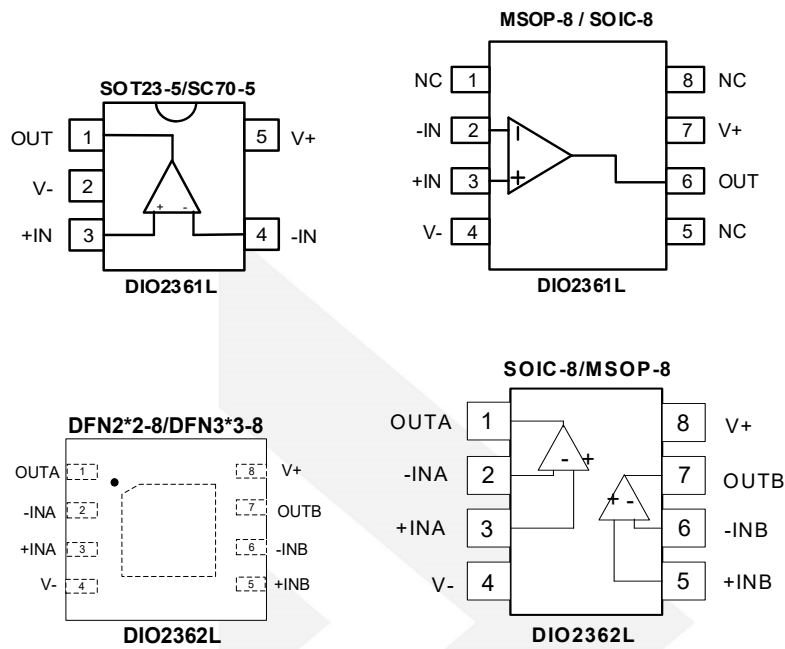

Figure 1 Top View

## Pin Description

Pin name	Description
V+	Positive supply
V-	Negative supply
+INX	Positive Input
-INX	Negative Input
OUTX	Output
NC	No connect

## Absolute Maximum Ratings

Stresses beyond those listed under "Absolute Maximum Rating" may cause permanent damage to the device. These are stress ratings only and functional operation of the device at these or any other condition beyond those indicated in the operational sections of the specifications is not implied. Exposure to absolute maximum rating conditions for extended periods may affect device reliability.

Parameter		Rating	Unit
Supply Voltage ( V+ – V-)		7	V
Input Voltage		(V-)-0.3V to (V+)+0.3V	V
Difference Input Voltage		V+ – V-	V
Storage Temperature Range		-65 to 150	°C
Junction Temperature		150	°C
Lead Temperature Range		260	°C
ESD	HBM, JEDEC: JESD22-A114	8	kV

## Recommended Operating Conditions

The Recommended Operating Conditions table defines the conditions for actual device operation to ensure optimal performance to the datasheet specifications. DIOO does not recommend exceeding them or designing to Absolute Maximum Ratings.

Parameter		Rating	Unit
Supply Voltage		1.8 to 5.5	V
Input Voltage		0 to 5	V
Operating Temperature Range		-40 to 125	°C



## Electrical Characteristics

Typical value:  $V_+ = 5V$ ,  $R_L = 1M\Omega$  to  $V_+/2$ ,  $V_{CM} = 1/2V_+$ ,  $T_A = 25^\circ C$ , unless otherwise specified.

Symbol	Parameter	Conditions	Min.	Typ.	Max.	Unit	
<b>INPUT CHARACTERISTICS</b>							
$V_{OS}$	Input Offset Voltage	$V_+ = 1.8V$ to $5.5V$	DIO2361LA/2LA	-10		10	$\mu V$
			DIO2361LB/2LB	-20		20	
			DIO2361L/2L	-40		40	
			DIO2361LM/2LM	-65		65	
$I_B$	Input Bias Current	$V_+ = 1.8V$ to $5.5V$		1		pA	
$I_{OS}$	Input Offset Current	$V_+ = 1.8V$ to $5.5V$		1		pA	
$V_{CM}$	Common Mode Voltage Range		-0.1		( $V_+$ ) +0.1	V	
CMRR	Common Mode Rejection Ratio	$-40^\circ C \leq T_A \leq 125^\circ C$		130		dB	
$A_{OL}$	Open Loop Voltage Gain	$R_L = 50k\Omega$ , $V_O = 0.1$ to $(V_+) - 0.1$	80	110		dB	
$\Delta V_{OS}/\Delta T$	Input Offset Voltage Drift	$-40^\circ C \leq T_A \leq 125^\circ C$		0.02		$\mu V/^\circ C$	
<b>OUTPUT CHARACTERISTICS</b>							
$V_{OH}$	Output Voltage High	$R_L = 50k\Omega$ , $-40^\circ C \leq T_A \leq 125^\circ C$		4.992		V	
$V_{OL}$	Output Voltage Low	$R_L = 50k\Omega$ , $-40^\circ C \leq T_A \leq 125^\circ C$		8		mV	
$I_{SC}$	Output Short Circuit Current	Source $I_{SC}$ , $V_+ = 5V$		34		mA	
		Sink $I_{SC}$ , $V_+ = 5V$		34			
<b>POWER SUPPLY</b>							
PSRR	Power Supply Rejection Ration		100			dB	
$I_S$	Supply Current per Channel/Amp	$-40^\circ C \leq T_A \leq 125^\circ C$		7	11	$\mu A$	
<b>DYNAMIC PERFORMANCE</b>							
GBP	Gain Bandwidth Product	$C_L = 100pF$ , $R_L = 1M\Omega$		110		kHz	
SR	Slew Rate	$G = 1$ , 2V Output Step		80		V/ms	
$t_s$	Setting Time	$G = 1$ , 2V Output Step		2		ms	
$\Theta_m$	Phase Margin			70		Deg	
$t_r$	Overload Recovery Time			3.9		ms	

## NOISE PERFORMANCE

THD	Total Harmonic Distortion	f=1kHz, 4V <sub>PP</sub> , R <sub>L</sub> =5kΩ	0.33	%
e <sub>n</sub>	Voltage Noise Density	f=1kHz	100	nV/√Hz

Specifications subject to change without notice.

## Typical Performance Characteristics

### I<sub>s</sub> vs. V<sub>CC</sub>

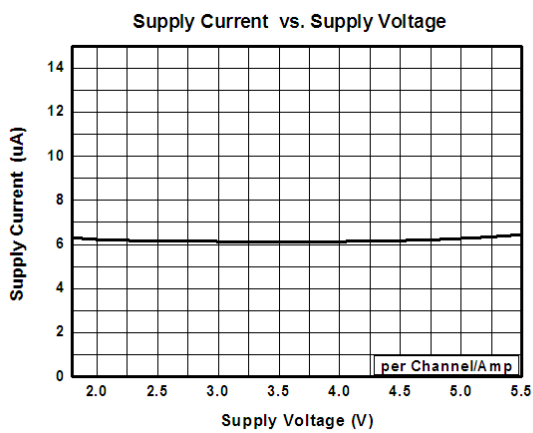

### I<sub>s</sub> vs. Temperature

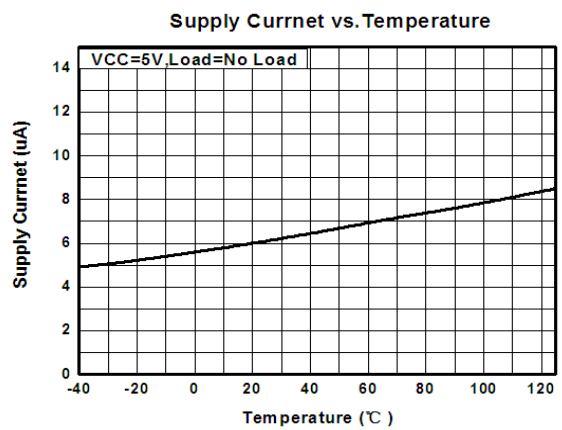

### V<sub>os</sub> vs. V<sub>CC</sub>

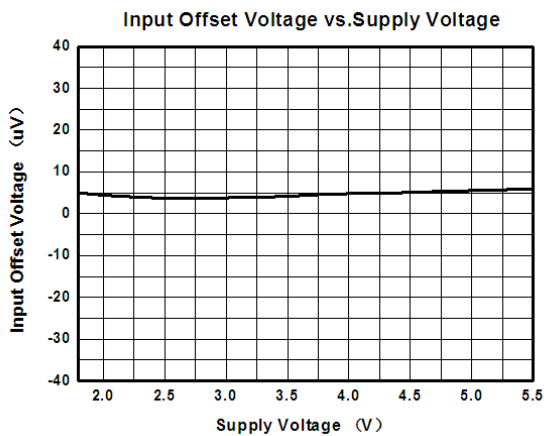

### V<sub>os</sub> vs. Temperature

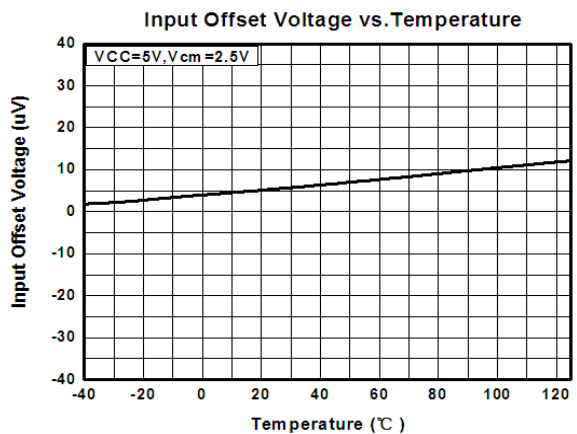

## Typical Performance Characteristics (Continue)

Small-signal Response  
( $V_{CC}=5V, C_L=200pF$ )

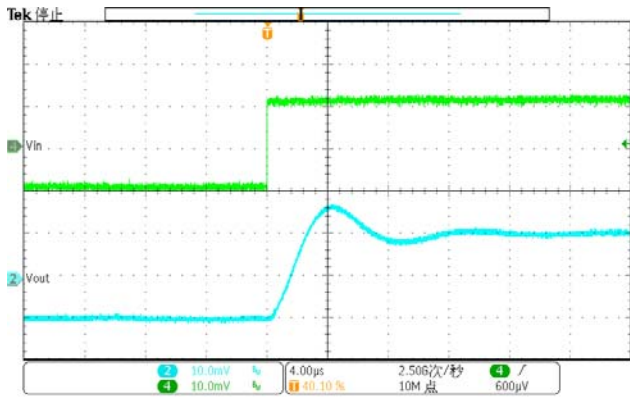

Small-signal Response  
( $V_{CC}=5V, C_L=200pF$ )

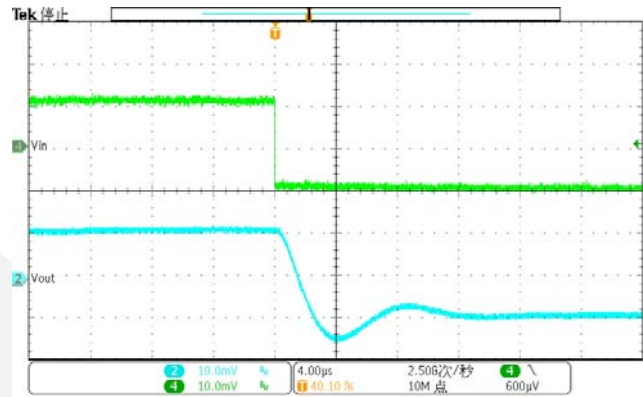

Large-signal Response  
( $V_{CC}=5V, R_L=5.1k\Omega$ )

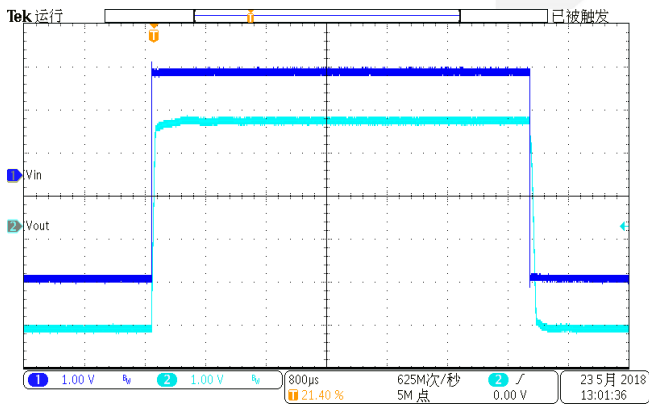

## Physical Dimensions: SC70-5

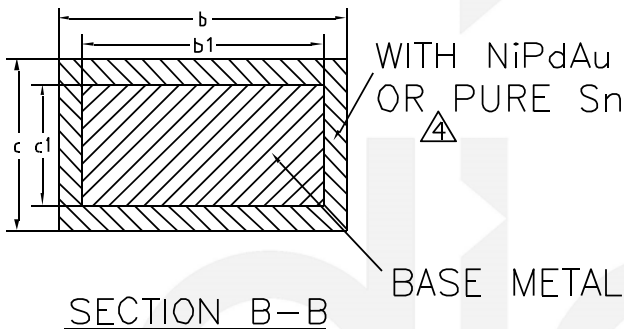
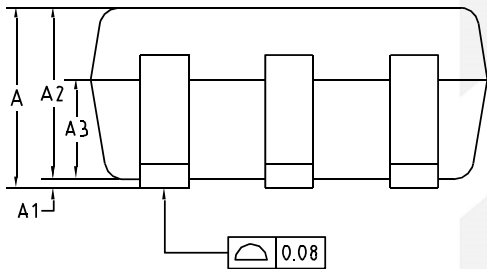
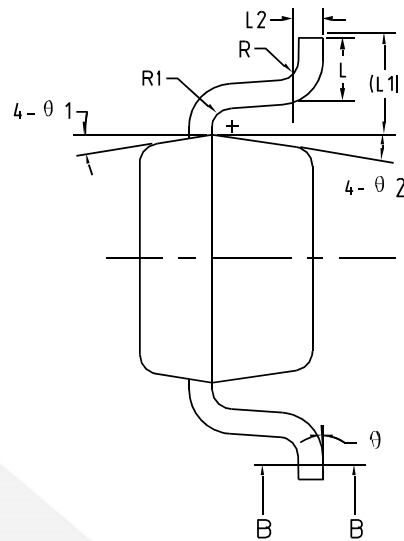
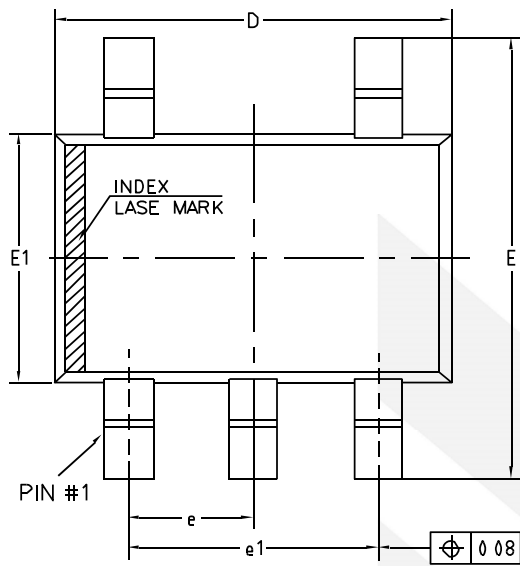

COMMON DIMENSIONS (UNITS OF MEASURE=MILLIMETER)			
Symbol	MIN	NOM	MAX
A	0.85	-	1.05
A1	0	-	0.10
A2	0.80	0.90	1.00
A3	0.47	0.52	0.57
b	0.23	-	0.33
b1	0.22	0.25	0.28
c	0.12	-	0.18
c1	0.115	0.13	0.14
D	2.02	2.07	2.12
E	2.20	2.30	2.40
E1	1.25	1.30	1.35
e	0.65BSC		
e1	1.30BSC		
L	0.28	0.33	0.38
L1	0.50REF		
L2	0.15BSC		
R	0.10	-	-
R1	0.10	-	0.25
θ	0°	-	8°
θ1	6°	9°	12°
θ2	6°	9°	12°



## Physical Dimensions: SOT23-5

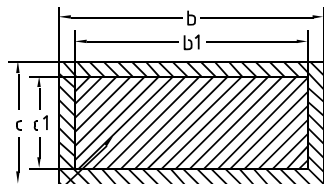
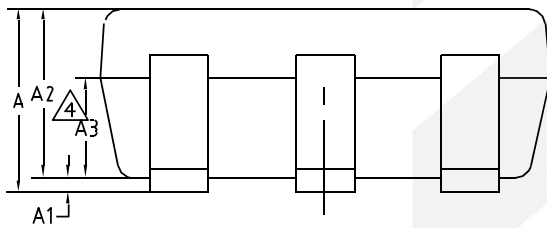
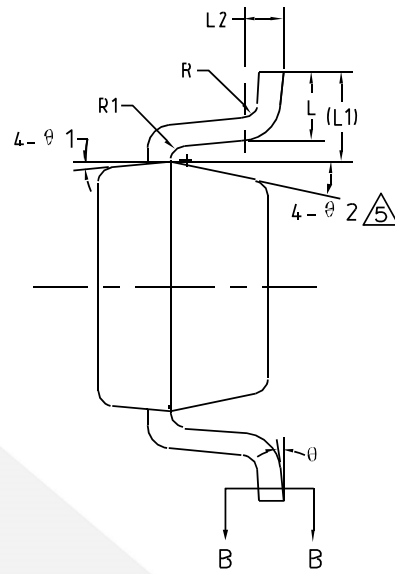
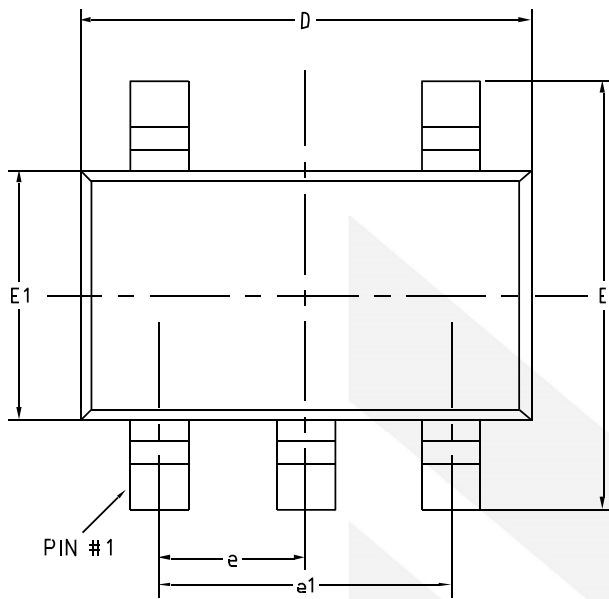

BASE METAL  
SECTION B-B

COMMON DIMENSIONS (UNITS OF MEASURE=MILLIMETER)			
Symbol	MIN	NOM	MAX
A	-	-	1.25
A1	0	-	0.15
A2	1.00	1.10	1.20
A3	0.60	0.65	0.70
b	0.36	-	0.50
b1	0.36	0.38	0.45
c	0.14	-	0.20
c1	0.14	0.15	0.16
D	2.826	2.926	3.026
E	2.60	2.80	3.00
E1	1.526	1.626	1.726
e	0.90	0.95	1.00
e1	1.80	1.90	2.00
L	0.35	0.45	0.60
L1	0.59REF		
L2	0.25BSC		
R	0.10	-	-
R1	0.10	-	0.25
θ	0°	-	8°
θ1	3°	5°	7°
θ2	6°	-	14°

## Physical Dimensions: DFN2\*2-8

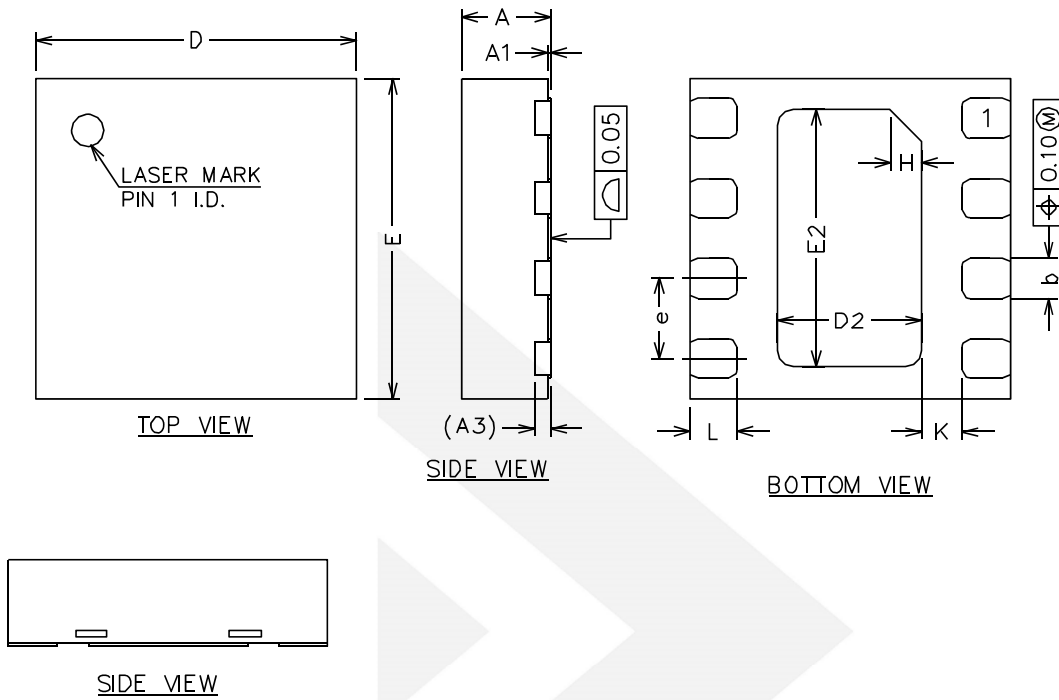

COMMON DIMENSIONS (UNITS OF MEASURE=MILLIMETER)			
Symbol	MIN	NOM	MAX
A	0.50	0.55	0.65
A1	0.00	0.02	0.05
A3	0.10REF		
b	0.20	0.25	0.30
D	1.90	2.00	2.10
E	1.90	2.00	2.10
D2	0.80	0.90	1.00
E2	1.50	1.60	1.70
e	0.40	0.50	0.60
H	0.20REF		
K	0.15	0.25	0.35
L	0.25	0.30	0.35

## Physical Dimensions: DFN3\*3-8

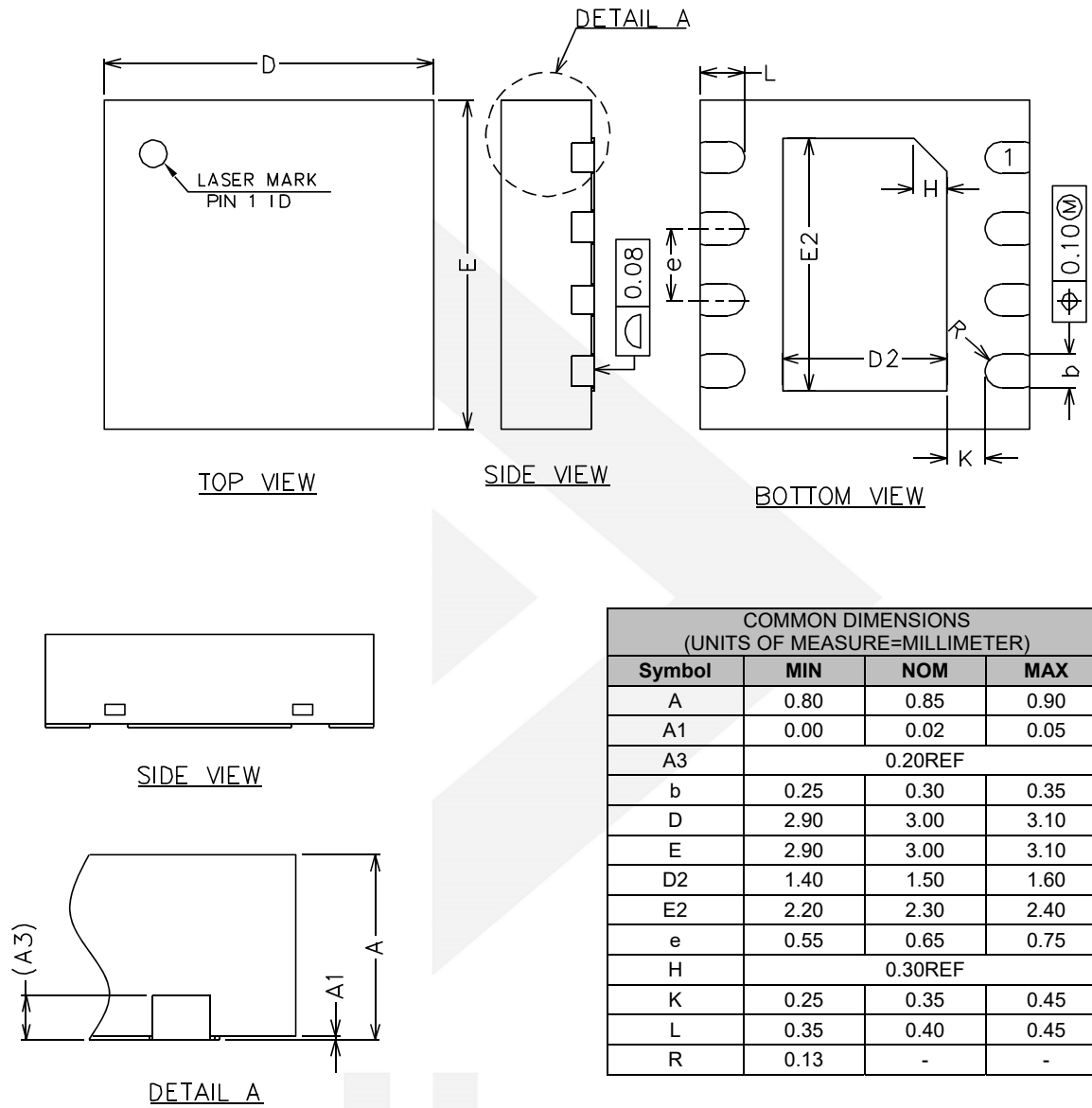

## Physical Dimensions: SOIC-8

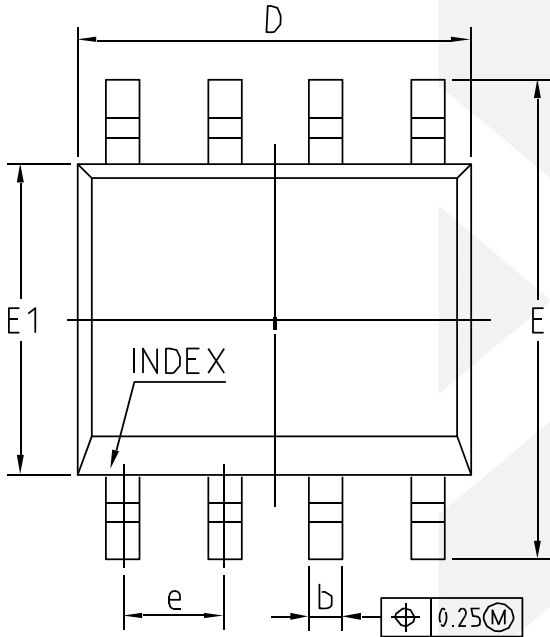
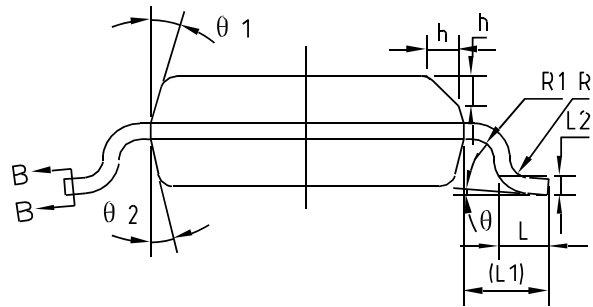
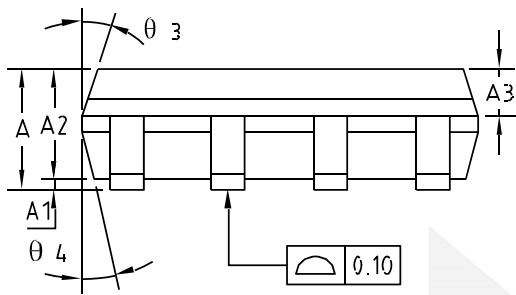

COMMON DIMENSIONS (UNITS OF MEASURE=MILLIMETER)			
Symbol	MIN	NOM	MAX
A	1.35	1.55	1.75
A1	0.10	0.15	0.25
A2	1.25	1.40	1.65
A3	0.50	0.60	0.70
b	0.38	-	0.51
b1	0.37	0.42	0.47
c	0.17	-	0.25
c1	0.17	0.20	0.23
D	4.80	4.90	5.00
E	5.80	6.00	6.20
E1	3.80	3.90	4.00
e	1.27BSC		
L	0.45	0.60	0.80
L1	1.04REF		
L2	0.25BSC		
R	0.07	-	-
R1	0.07	-	-
h	0.30	0.40	0.50
theta	0°	-	8°
theta 1	15°	17°	19°
theta 2	11°	13°	15°
theta 3	15°	17°	19°
theta 4	11°	13°	15°

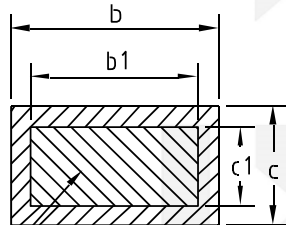

BASE METAL

SECTION B-B

## Physical Dimensions: MSOP-8

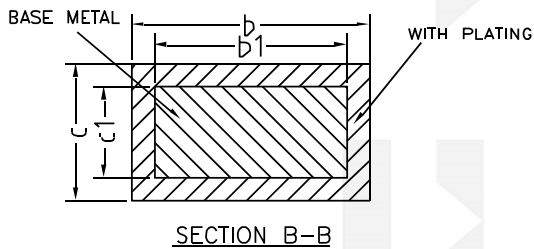
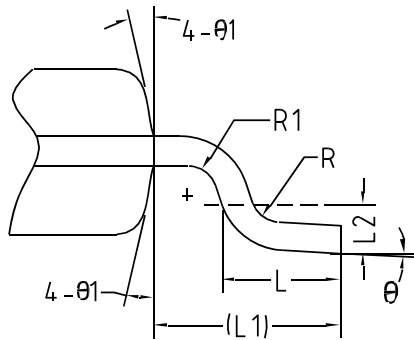
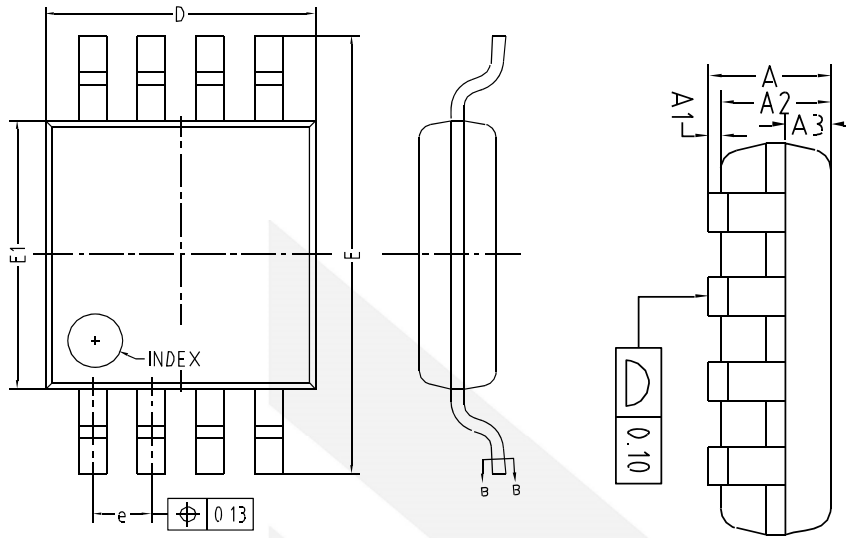

COMMON DIMENSIONS (UNITS OF MEASURE=MILLIMETER)			
Symbol	MIN	NOM	MAX
A	-	-	1.10
A1	0	-	0.15
A2	0.75	0.85	0.95
A3	0.25	0.35	0.39
b	0.28	-	0.37
b1	0.27	0.30	0.33
c	0.15	-	0.20
c1	0.14	0.15	0.16
D	2.90	3.00	3.10
E	4.70	4.90	5.10
E1	2.90	3.00	3.10
e	0.55	0.65	0.75
L	0.40	0.60	0.80
L1	0.95REF		
L2	0.25BSC		
R	0.07	-	-
R1	0.07	-	-
θ	0°	-	8°
θ1	9°	12°	15°

## CONTACT US

**Dioo** is a professional design and sales corporation for high-quality and performance analog semiconductors. The company focuses on industry markets, such as, cell phone, handheld products, laptop, and medical equipment and so on. Dioo's product families include analog signal processing and amplifying, LED drivers and charger IC. Go to <http://www.dioo.com> for a complete list of Dioo product families.

For additional product information, or full datasheet, please contact with our Sales Department or Representatives.

A large, light gray watermark of the Dioo logo is centered on the page. It consists of a stylized arrow pointing right above the word "dioo" in a lowercase, sans-serif font.