

SURFACE MOUNT LED AMBER, 0603 PACKAGE

BIVAR

SM0603AC

- ◆ Industry Standard 0603 Package
- ◆ RoHS Compliant
- ◆ Small Package and Footprint
- ◆ Water Clear Lens
- ◆ Wide Viewing Angle
- ◆ Ideal for Status Indication, Display, and Backlighting

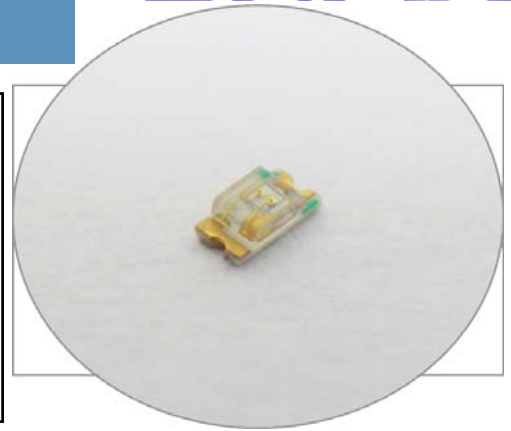

Bivar Surface Mount 0603 package LED may be used in nearly any lighting or indication application. The miniature package is ideal for small scale applications such as general indication and backlighting. Low power consumption and excellent long life reliability are suitable for battery powered equipment. Bivar offers water clear LED lens for maximum luminous intensity. Wide variety of wavelength and intensity combinations are available to meet any illumination need. The SM0603 LED is packaged in standard tape and reels for pick and place assemblies.

| Part Number | Material | Emitted Color | Peak Wavelength λ_p (nm) TYP. | Lens Appearance | Luminous Intensity (mcd) TYP. | Viewing Angle |
|-------------|----------|---------------|---------------------------------------|-----------------|-------------------------------|---------------|
| SM0603AC | GaAsP | AMBER | 610 | Water Clear | 6 | 130° |

Outline Dimensions

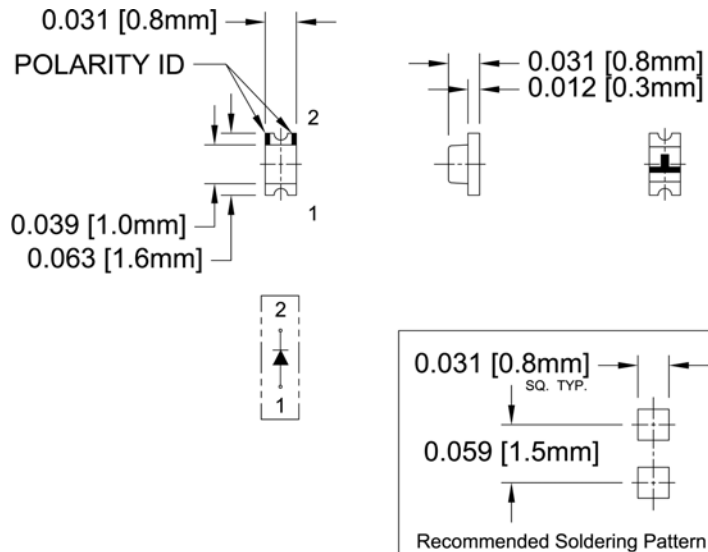

Outline Drawings Notes:

1. All dimensions are in inches [millimeters].
2. Standard tolerance: $\pm 0.010''$ unless otherwise noted.



Bivar reserves the right to make changes at any time without notice.

Absolute Maximum Ratings

$T_A = 25^\circ\text{C}$ unless otherwise noted

| | |
|--|-------------|
| Power Dissipation | 78 mW |
| Forward Current (DC) | 30 mA |
| Peak Forward Current ¹ | 100 mA |
| Reverse Voltage | 5 V |
| Operating Temperature Range | -30 ~ +80°C |
| Storage Temperature Range | -40 ~ +85°C |
| Lead Soldering Temperature (3 mm from the base of the epoxy bulb) ² | 260°C |

Notes: 1. 10% Duty Cycle, Pulse Width \leq 0.1 msec. 2. Solder time less than 5 seconds at temperature extreme.

Electrical / Optical Characteristics

$T_A = 25^\circ\text{C}$ & $I_F = 20$ mA unless otherwise noted

| Part Number | Forward Voltage (V) ¹ | | | Recommend Forward Current (mA) | | | Reverse Current (μA) | Dominant Wavelength (nm) ² | | | Luminous Intensity I_v (mcd) | | | Viewing Angle $2\theta_{1/2}$ (deg) |
|-------------|----------------------------------|-----|-----|--------------------------------|-----|-----|-----------------------------------|---------------------------------------|-----|-----|--------------------------------|-----|-----|-------------------------------------|
| | MIN | TYP | MAX | MIN | TYP | MAX | MAX | MIN | TYP | MAX | MIN | TYP | MAX | TYP |
| SM0603AC | / | 2.0 | 2.6 | / | 20 | / | 10 | / | 607 | / | 1 | 6 | / | 130 |

Notes: 1. Tolerance of forward voltage : $\pm 0.05\text{V}$. 2. Tolerance of dominant wavelength : $\pm 1.0\text{nm}$.

Typical Electrical / Optical Characteristics

$T_A = 25^\circ\text{C}$ unless otherwise noted

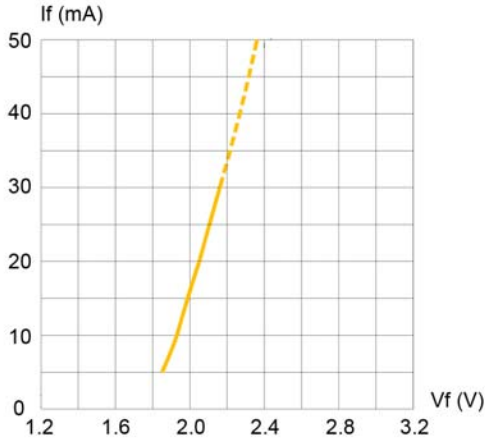

Fig. 1 Forward Current vs. Forward Voltage

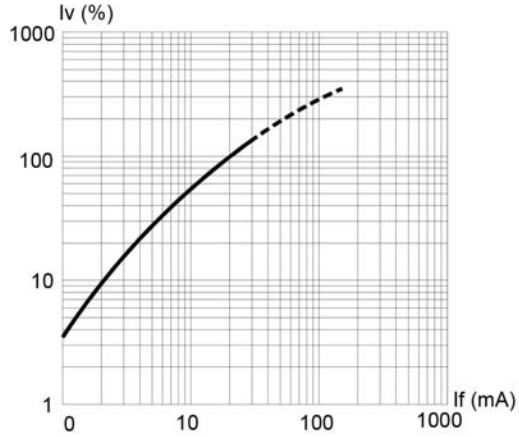

Fig. 2 Relative Luminous Intensity vs. Forward Current

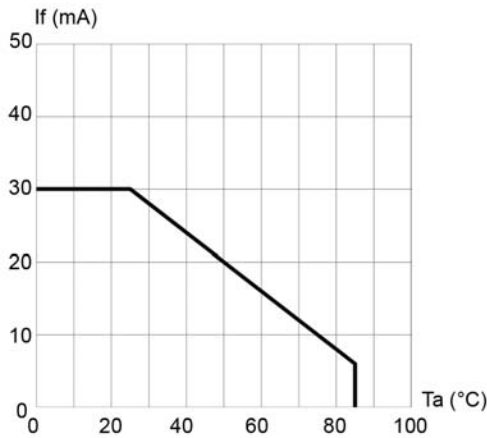

Fig. 3 Forward Current vs. Temperature

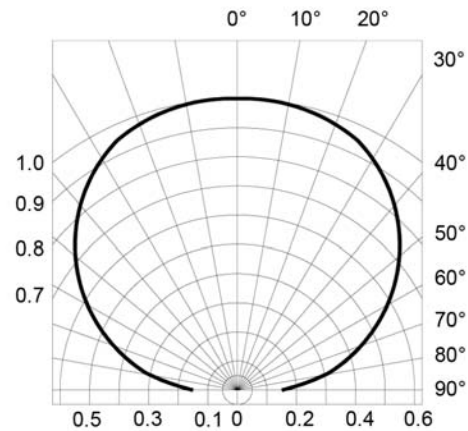

Fig. 4 Directivity Radiation Diagram

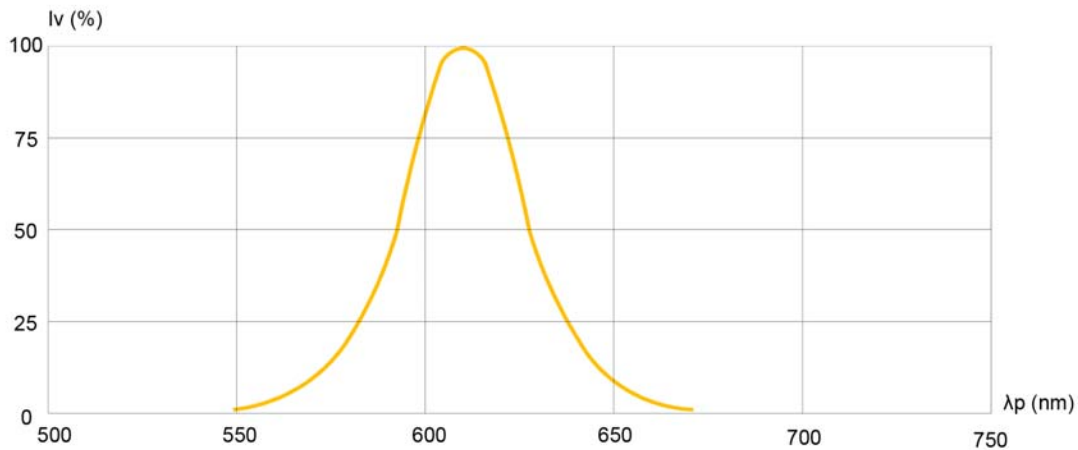

Fig. 5 Relative Luminous Intensity vs. Peak Wavelength

Bivar reserves the right to make changes at any time without notice.

SURFACE MOUNT LED AMBER, 0603 PACKAGE



Recommended Soldering Conditions

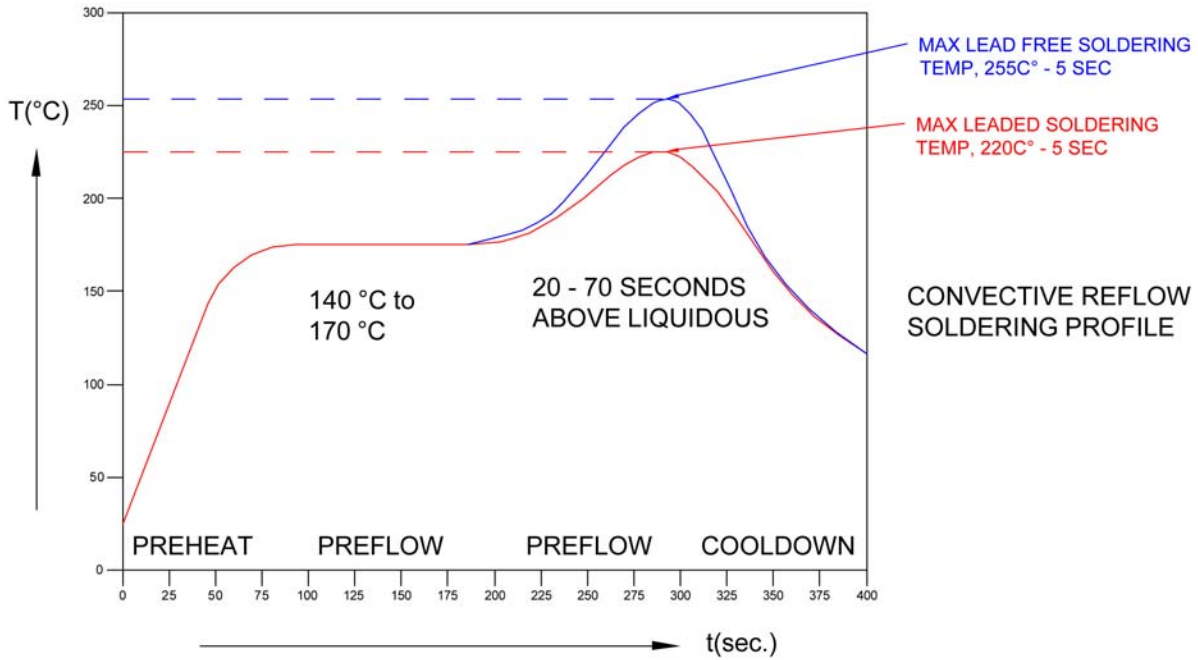

Tape and Reel Dimensions

Note: 4000 pcs/Reel

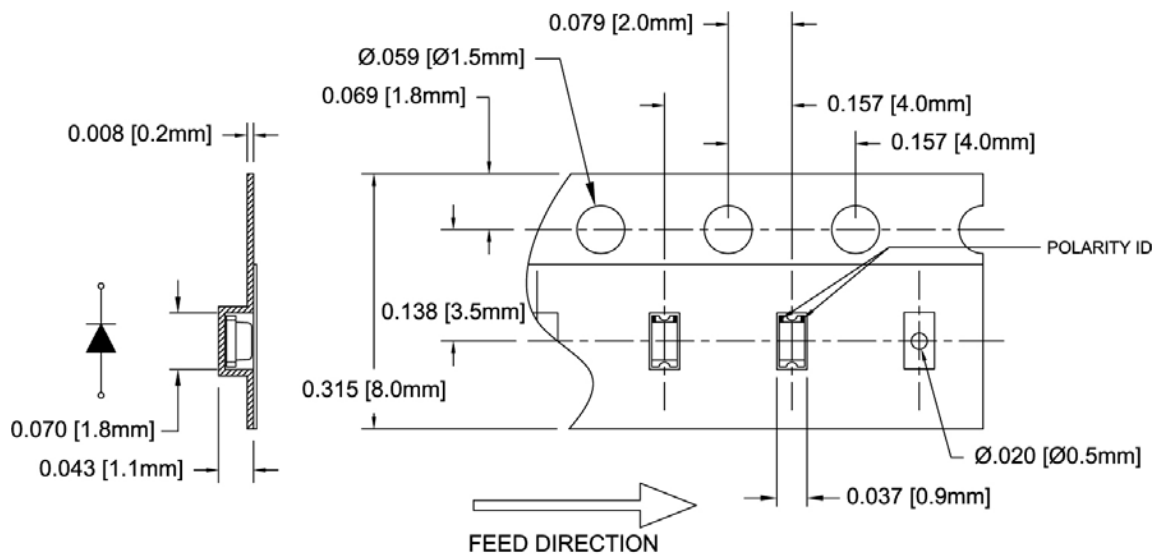

Outline Drawings Notes:

1. All dimensions are in inches [millimeters].
2. Standard tolerance: $\pm 0.010''$ unless otherwise noted.

Bivar reserves the right to make changes at any time without notice.

SURFACE MOUNT LED AMBER, 0603 PACKAGE



Outline Drawings Notes:

1. All dimensions are in inches [millimeters].
2. Standard tolerance unless otherwise noted: X.XXX \pm 0.010"
X.X \pm 0.1"

Packaging and Labeling Plan

Note: 1 Reel / Bag

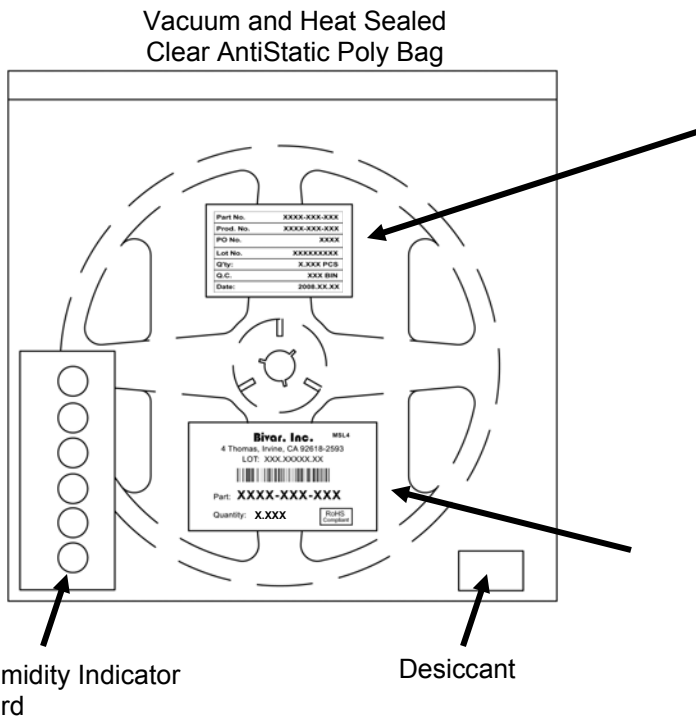

| | |
|-----------|--------------|
| Part No. | XXXX-XXX-XXX |
| Prod. No. | XXXX-XXX-XXX |
| PO No. | XXXX |
| Lot No. | XXXXXXXXXX |
| Q'ty: | X.XXX PCS |
| Q.C. | XXX BIN |
| Date: | 2008.XX.XX |

Internal Quality Control

Bivar, Inc. MSL4

4 Thomas, Irvine, CA 92618-2593
LOT: XXX.XXXXX.XX



Part: **XXXX-XXX-XXX**

Quantity: **X.XXX**

RoHS
Compliant

Bivar Standard Packaging Label

Bivar reserves the right to make changes at any time without notice.