

# PVT4 SERIES ANTI-VANDAL SWITCH

ANTI-VANDAL SWITCHES  
DETECTOR SWITCHES  
DIP SWITCHES  
KEYLOCK SWITCHES  
NAVIGATION SWITCHES  
PUSHBUTTON SWITCHES  
ROCKER SWITCHES  
ROTARY SWITCHES  
SLIDE SWITCHES  
SNAP ACTION SWITCHES  
TACTILE SWITCHES  
TOGGLE SWITCHES  
CAP OPTIONS

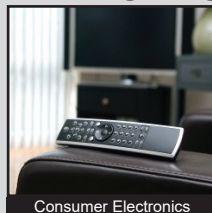

## APPLICATIONS / MARKETS



**RoHS**

## SPECIFICATIONS

**Electrical Rating:** 50mA, 24VDC  
**Electrical Life:** 500,000 Cycles  
**Contact Resistance:** 50mΩ Max.  
**Insulation Resistance:** 1000 MΩ Min.  
**Dielectric Strength:** 250VAC  
**Operating/Storage Temperature:** -25°C to 55°C  
**Travel:** 0.5mm  
**Moisture Protection:** IP65  
**Contact Arrangement:** SPST Off-(On)  
**Actuation Force:** 490 grams  
**Panel Thickness:** 1-6mm  
**Mounting Nut Torque:** 0.8Nm

## FEATURES & BENEFITS

- 19mm panel cutout
- Solder or wire lead termination options
- Ring illumination
- LED color options
- Crisp tactile response
- IP65 rated

## PART NUMBER CONFIGURATOR

Series	Actuator Options	Terminal Options	Function Options	Housing Options	Button Finish	Lens Style	LED Color	LED Voltage Options
<input type="text" value="PVT4"/>	<input type="text" value="F - Flat"/>	<input type="text" value="S - Solder Lug&lt;br/&gt;W - Wire leads&lt;br/&gt;300mm"/>	<input type="text" value="4 - Off - (On)*"/>	<input type="text" value="S - Stainless&lt;br/&gt;Stainless"/>	<input type="text" value="S - Stainless&lt;br/&gt;Stainless"/>	<input type="text" value="3 - Ring&lt;br/&gt;Illumination"/>	<input type="text" value="0 - White&lt;br/&gt;1 - Red&lt;br/&gt;2 - Orange&lt;br/&gt;3 - Green&lt;br/&gt;4 - Blue&lt;br/&gt;5 - Yellow"/>	<input type="text" value="1 - Base Voltage&lt;br/&gt;3 - 6V&lt;br/&gt;4 - 12V&lt;br/&gt;5 - 24V"/>

NOTES:  
\*(ON) Denotes function is momentary

Specifications subject to change without notice 6.5.2018



**E-SWITCH®**

www.e-switch.com

800.867.2717

1

# PVT4 SERIES ANTI-VANDAL SWITCH

## SOLDERLUG TERMINATION

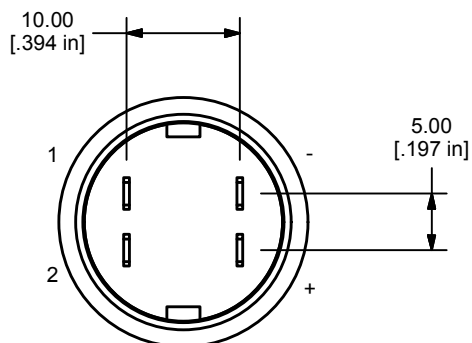
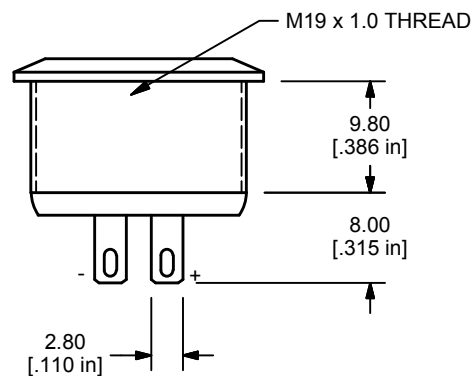
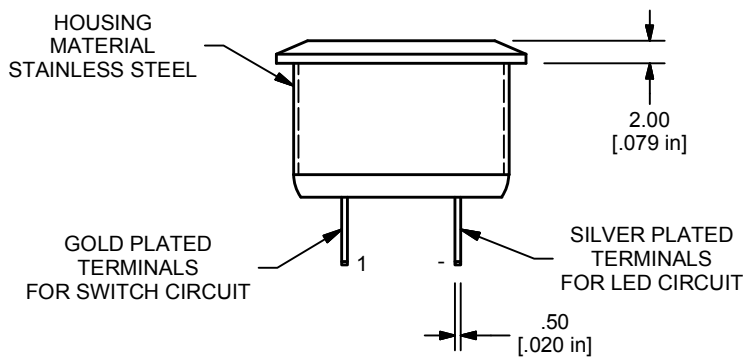
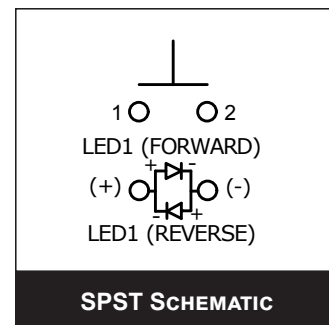
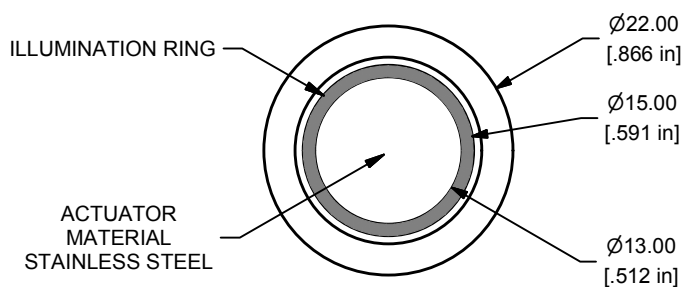
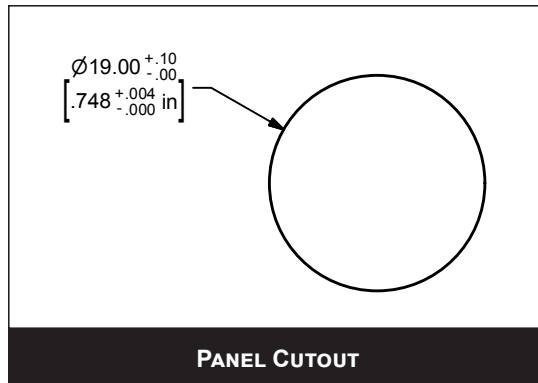

# PVT4 SERIES ANTI-VANDAL SWITCH

## WIRE LEAD TERMINATION

ANTI-VANDAL SWITCHES  
DETECTOR SWITCHES  
DIP SWITCHES  
KEYLOCK SWITCHES  
NAVIGATION SWITCHES  
PUSHBUTTON SWITCHES  
ROCKER SWITCHES  
ROTARY SWITCHES  
SLIDE SWITCHES  
SNAP ACTION SWITCHES  
TACTILE SWITCHES  
TOGGLE SWITCHES  
CAP OPTIONS

