

CoreSync PoE Gateway



The CoreSync PoE Gateway is a low voltage power distribution and network connected module that utilizes PoE (Power Over Ethernet) technology.



Features and Advantages

Cisco UPOE Compliant Device	Optimized to deliver low voltage power and reliable communication with lights, sensors and other devices
Input power up to 60W	Capable of powering a single LED fixture or multiple lower-wattage fixtures
CoAP Network Communication	Easy and secure convergence of IP infrastructure
Rugged and robust interfaces: Category5/6, Molex Micro-Fit	Familiar and easy to connect and disconnect; allow daisy-chain capability
Fully integrated to Molex CoreSync Lighting Control System	Distribute power and data to lights, sensors and other CoreSync devices locally
UL2108	Safe operation and industry-standard compliance

PoE Gateway on the CoreSync Architecture

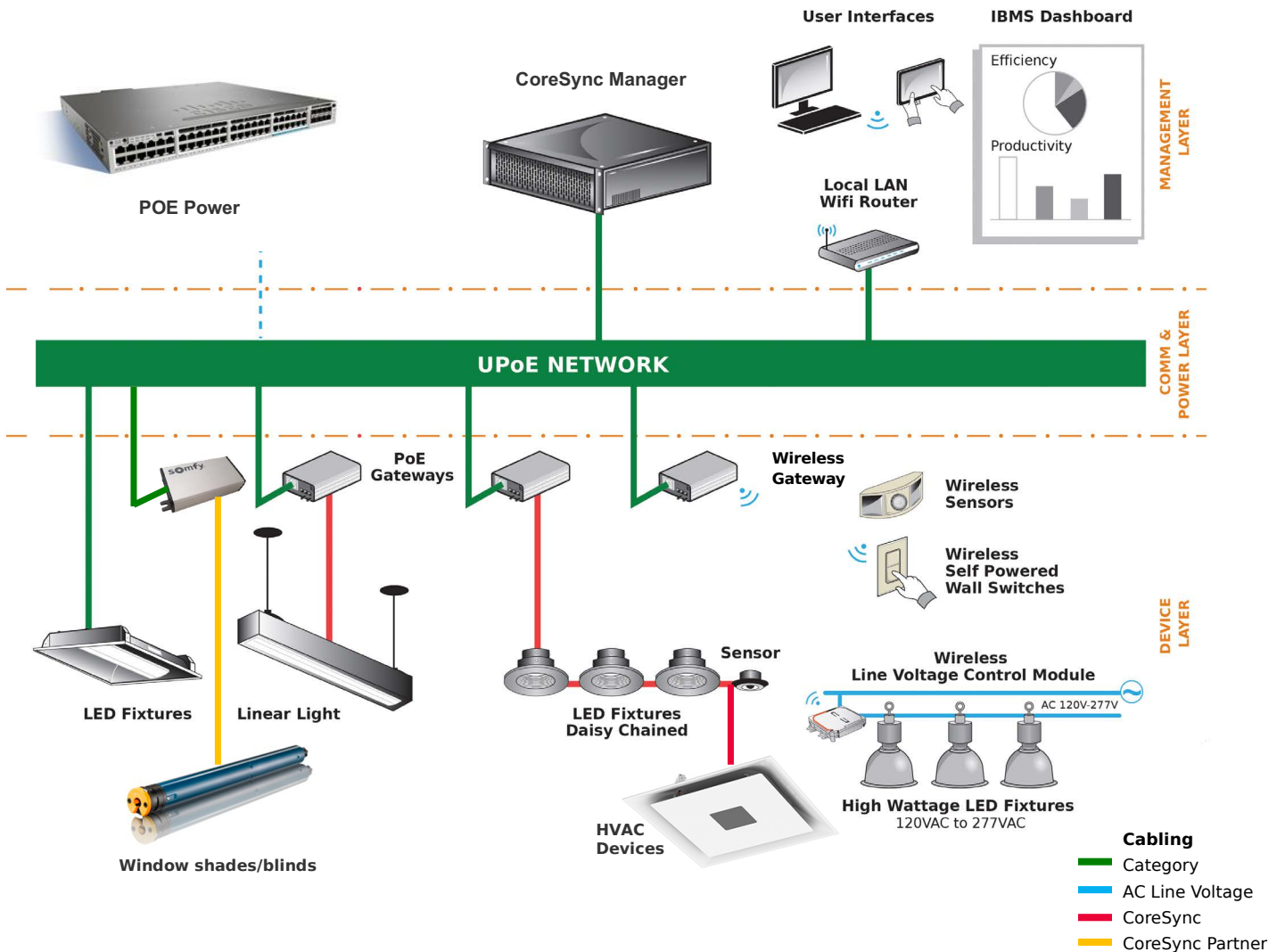





CoreSync PoE Gateway

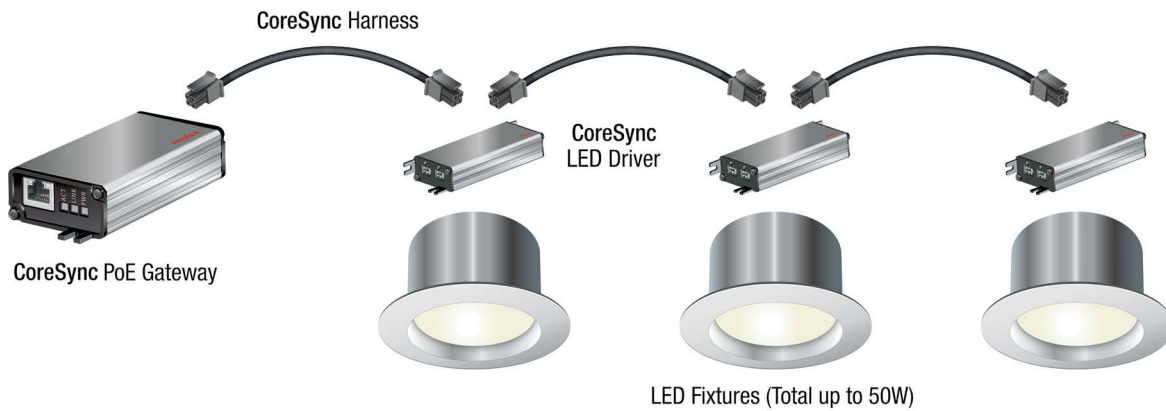

Daisy Chain Arrangement



Gateway Family and Applications

<i>Voltage Output Unregulated</i>	<i>Voltage Output Unregulated - Plastic Body</i>	<i>Constant Current Output</i>	<i>Data Wireless Gateway (enOcean®)</i>
			
<i>Connect</i>			
LED Drivers, Actuators, Sensors Nodes, Low Voltage Loads	LED Drivers, Actuators, Sensors Nodes, Low Voltage Loads	LED Engines, Sensors	Self-Powered Wall Switches, Sensors, Dimmers, Relays
<i>Best Application</i>			
LED Fixtures With DC/DC Driver. Dispensers, Motorized Shades, Daisy Chain	Directly Mounted Inside Direct/Indirect LED Fixtures, Task Lights, Linear Fixtures, LED Modules	LED Fixtures Without Cc Regulation	Self-Powered Local Controls, Wireless Sensors, Relays, AC/DC Fixtures
<i>Enclosure</i>			
Aluminum Anodized Silver With Black End Caps	Black Molded Plastic	Aluminum Anodized Silver With Black End Caps	Powder Coat White With Grey End Caps

Specifications

ELECTRIC

Nominal Power Input 60W
 UPOE IEEE802.3bt (compatible with POE/POE+)
 Standby Power Consumption 0.5W
 Nominal Power Output 50W
 Light Interface: CV or CC depending on model
 Class-II electrical device
 UL2108

ENVIRONMENTAL

Ambient Temp Range: 0 to 40°C (32 to 104°F)
 Max. Operating Temp: 40°C (104°F)
 Relative Humidity: 10-80% Non-Condensing
 Environmental Rating: Indoor

CONNECTION INTERFACES

Catalyst Switch End: RJ45
 Device End: Micro-Fit connector 10-pin
 Sensor Interface: CoreSync Bus
 Actuator Interface: CoreSync Bus

MECHANICAL

Housing Material: Extruded Aluminum
 Length: 119.65 mm
 Width: 53.33 mm
 Depth: 25.51 mm
 Weight: 100g

Dimensions

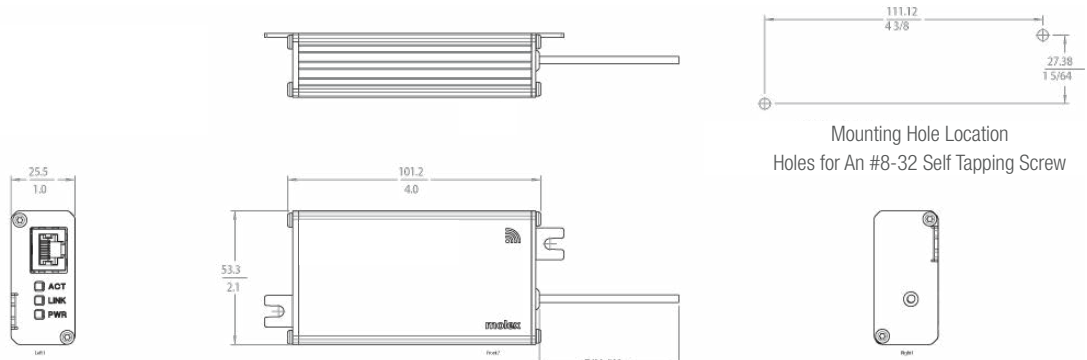

Wireless Gateway (North American/EU)

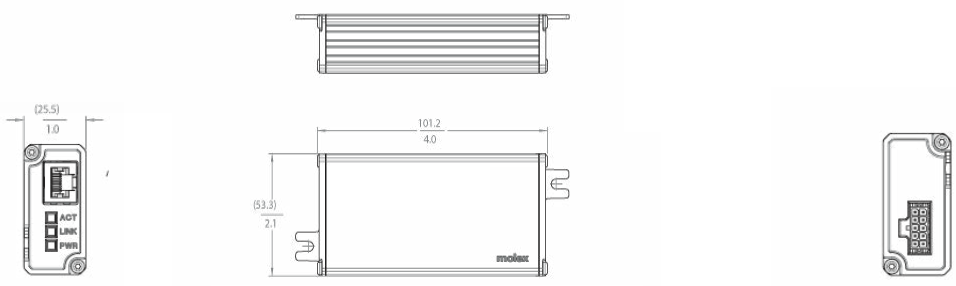

Standalone Unregulated Gateway

Ordering Information

Order No.	Description
180993-0001	Gateway Voltage Output Unregulated, Input RJ45 UPOE 802.3xx, Output 25/50W, 42-56V Unregulated, Aux Output 5V, CoreSync 10-Pin Micro-fit Connector, 0-10V Dimming interface, UL CE
180993-3001	Wireless Gateway, Input RJ45 UPOE 802.3xx, Wireless Dimming interface, Wireless sensor interface, UL North America
180993-3002	Wireless Gateway, Input RJ45 UPOE 802.3xx, Wireless Dimming interface, Wireless sensor interface, CE