

## Features

- Monolithic Construction
- Low Insertion Loss ( < 0.5 dB )
- Good Port to Port Isolation ( > 20 dB )
- Low Amplitude ( 0.2 dB ) and Phase Imbalance ( 1° ).
- Output Port Isolation ~30 dB
- SOT-26 Low Cost Miniature Plastic Package
- RoHS Compliant

## Description and Applications

M/A-COM's MAPD-000900-12920T is a 50 Ω Characteristic Impedance, Monolithic Passive Integrated Circuit designed to provide a 0 degree phase shift during an RF power split. The die uses M/A-COM's unique glass process to realize low loss and high Q passive elements while retaining the advantages of overall size and exceptional reproducibility.

These power splitters/combiners are well suited for use in 50 Ω Rx/Tx system applications particularly where small size and parametric repeatability are essential. Typical applications include usage within RF systems where synthesizer sources are used to drive separate receiver and transmitter sections.

## Absolute Maximum Ratings<sup>1</sup>

Parameter	Maximum Ratings
Operating Temperature	-40 °C to +85 °C
Storage Temperature	-65 °C to +150 °C
RF C.W. Incident Power	+30 dBm C.W.

1. Exceeding these limits may cause permanent damage.

## SOT-26 Package Outline (Topview)

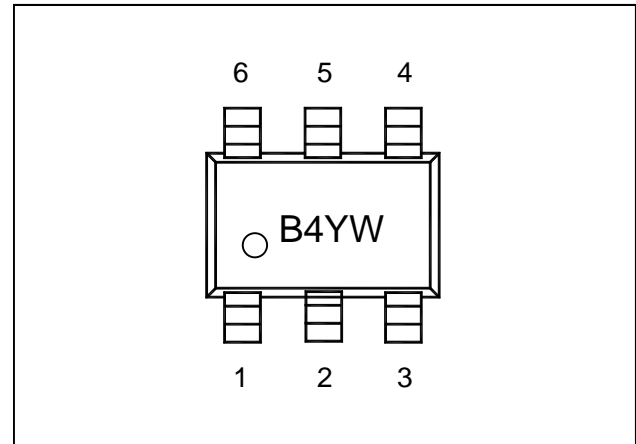

## Pin Configuration

PIN	Function	PIN	Function
1	RF Output	4	N/C
2	GND	5	RF Input
3	RF Output	6	N/C

## Schematic

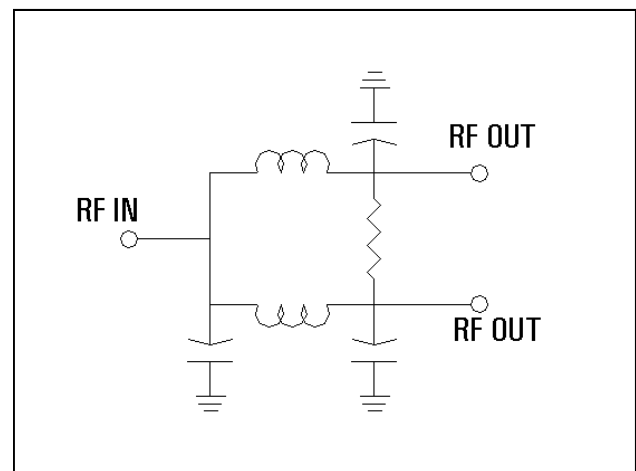

## Electrical Specifications @ +25 °C

Parameter	Frequency Range	Units	Min.	Typ.	Max.
Insertion Loss	900 MHz 800-980 MHz	dB		0.3 0.3	0.5 0.6
Isolation	900 MHz 800-980 MHz	dB	28 20	30.0 27.0	
Input Return Loss	900 MHz 800-980 MHz	dB	19 16	21.0 21.0	
Output Return Loss	900 MHz 800-980 MHz	dB	26 21	28.0 28.0	
Amplitude Balance	900 MHz 800-980 MHz	dB		0.05 0.05	0.2 0.2
Phase Balance	900 MHz 800-980 MHz	deg		0.1 0.3	0.5 1.0

## Typical Performance Curves

Temperature Legend: ( - - - - -40°C, — 25°C, - - - - 85°C)

**RF Input to RF Output Insertion Loss**

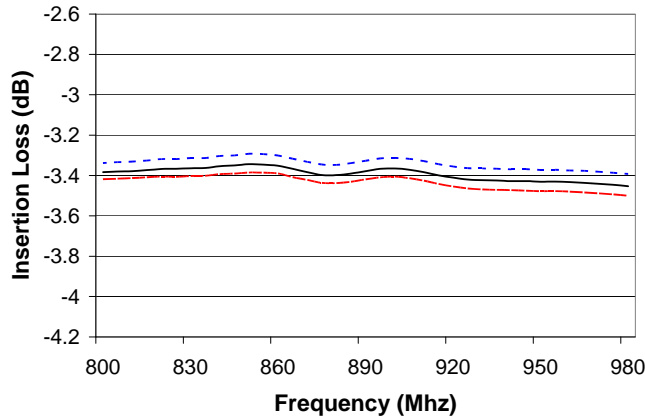

**Output Port to Port Isolation**

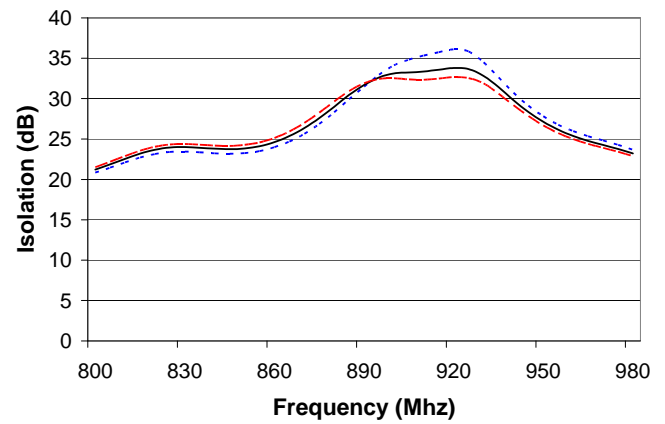

**Input Return Loss**

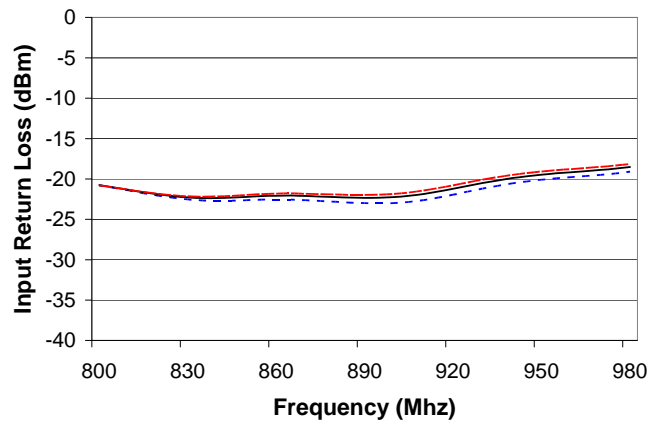

**Output Return Loss**

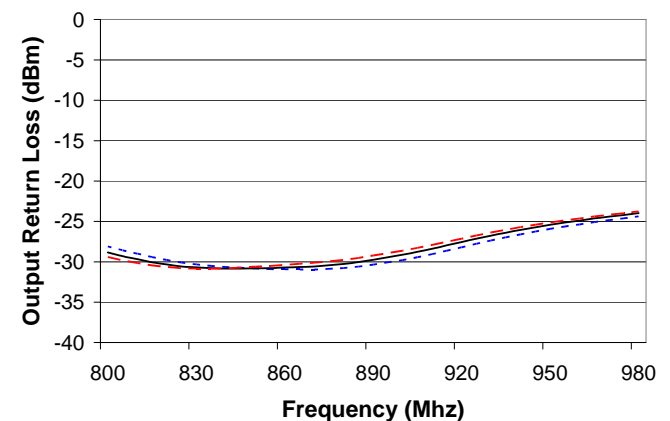

**Delta Magnitude**

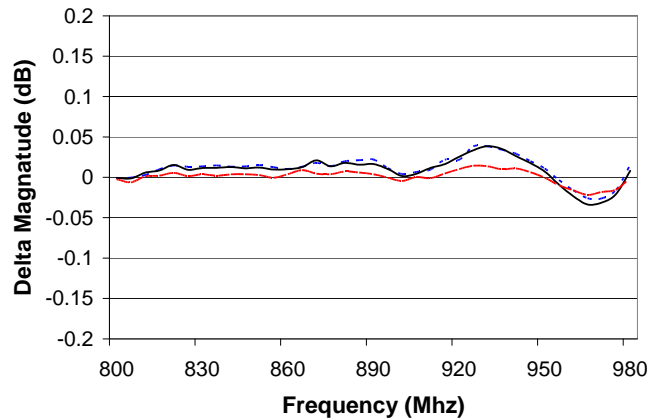

**Delta Phase**

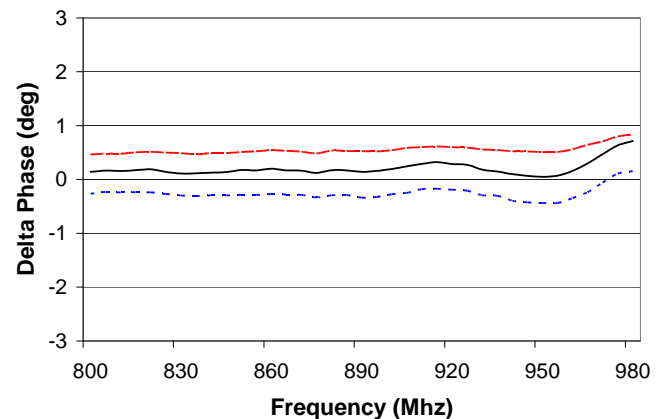

## Case Style - SOT-26

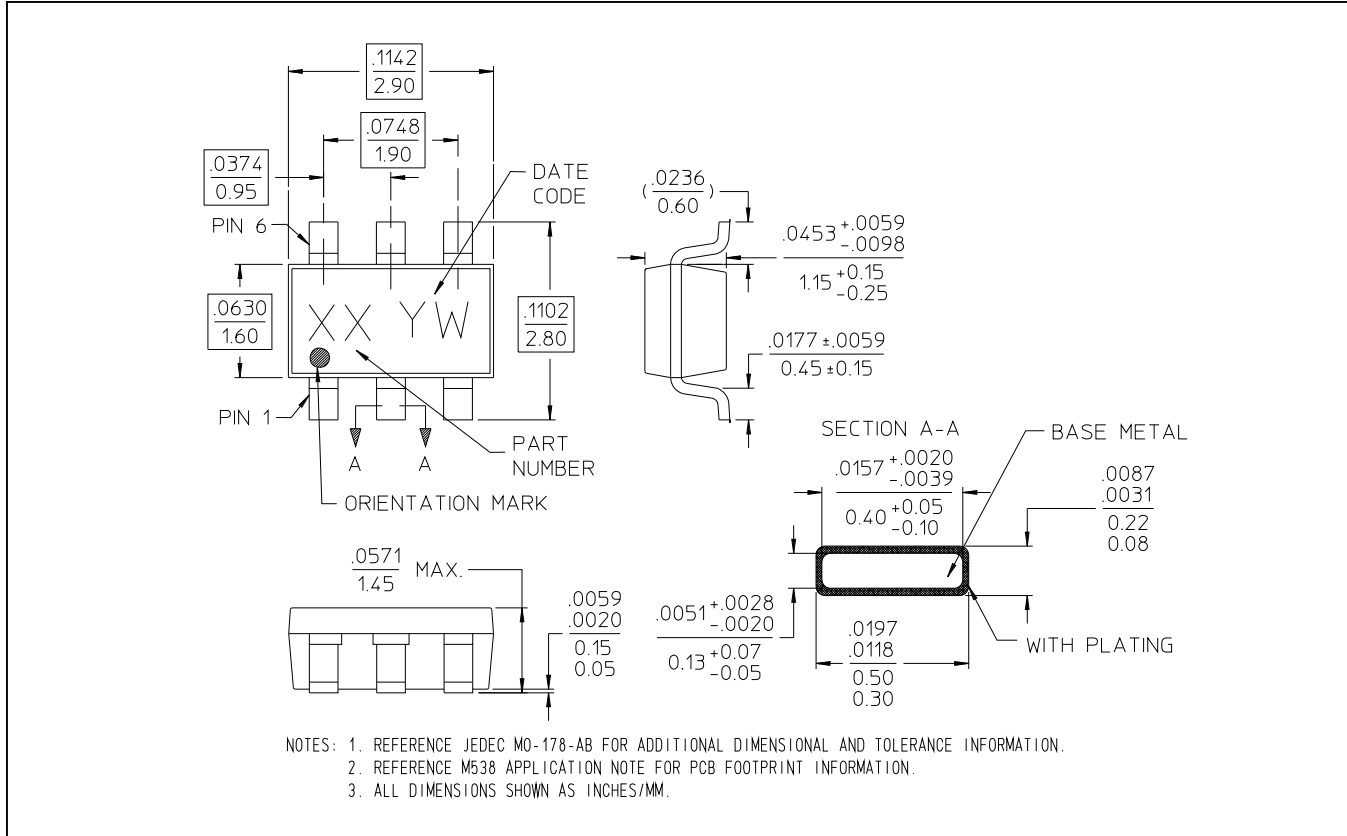

## Ordering Information

Part Number	Package
MAPD-000900-12920T	Tape and Reel