

**RFI Power Line Filters for DC Applications**

# DC Series



UL Recognized  
CSA Certified  
TUV Certified



60DCF6B



15DCF10

## DC Series

- General purpose line filters for DC applications up to 125VDC
- Available with or without a circuit breaker
- Available with feedthrough capacitors for added high frequency performance
- Available in both flange mount (DCF) and bulkhead mount (DCB) configuration

## Ordering Information

60 DC B 6 B

### Options

- B - Circuit breaker
  - F - Feedthrough capacitors
  - BF - Circuit breaker and feedthrough
- F and BF available only in bulkhead (B) mounting style*
- Omit for none

### Input / Output Styles

- 6 - Redundant stud
- 10 - Phoenix terminal

### Mounting Style

- F = Flange
  - B = Bulkhead and rack
- Required for F or BF options*

### DC Series

- Current Rating
- 15, 30, 60, 100 or 125A

## Specifications

### Hipot rating (one minute):

Line to Ground:	2250 VDC
Line to Line:	1450 VDC

### Rated Voltage (max):

80 VDC

### Rated Current:

15 to 125A

### Operating Ambient Temperature Range

(at rated current  $I_r$ ): -10°C to +55°C

In an ambient temperature ( $T_a$ ) higher than +55°C the maximum operating current ( $I_o$ ) is calculated as follows:  $I_o = I_r \sqrt{(85-T_a)/30}$

## Electrical Schematics

### Standard Performance

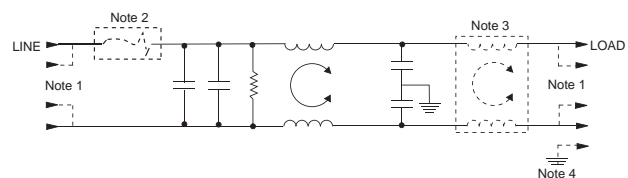

### High Frequency Performance (F & BF Styles)

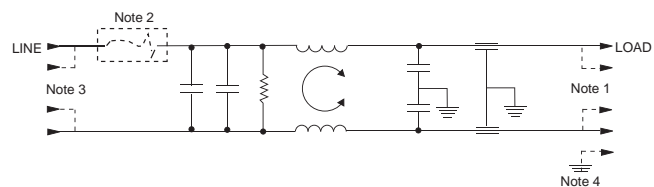

- Note 1: Depicts redundant style 6 terminals.
- Note 2: Depicts optional circuit breaker.
- Note 3: For 100 & 125A versions delete second coil.
- Note 4: Depicts style 10 terminal versions which have separate ground stud.

**RFI Power Line Filters for DC Applications** *(continued)*

# DC Series

## Available Part Numbers

Standard Performance		High Performance	
15DCF6	15DCF10	15DCB10F	15DCB6F
30DCF6	30DCF10	30DCB10F	30DCB6F
60DCF6	60DCF10	60DCB10F	60DCB6F
100DCF6	100DCF10	100DCB10F	100DCB6F
125DCF6	125DCF10	125DCB10F	125DCB6F
15DCF6B	15DCF10B	15DCB6BF	
30DCF6B	30DCF10B	30DCB6BF	
60DCF6B	60DCF10B	60DCB6BF	
100DCF6B	100DCF10B	100DCB6BF	
125DCF6B	125DCF10B	125DCB6BF	
15DCB6	15DCB10	15DCB10BF	
30DCB6	30DCB10	30DCB10BF	
60DCB6	60DCB10	60DCB10BF	
100DCB6	100DCB10	100DCB10BF	
125DCB6	125DCB10	125DCB10BF	
15DCB6B	15DCB10B		
30DCB6B	30DCB10B		
60DCB6B	60DCB10B		
100DCB6B	100DCB10B		
125DCB6B	125DCB10B		

## Termination Options

### Style 6 (15, 30 & 60A)

- Supplied with #10-32 redundant studs
- 0.625 [*15.88*] spacing like polarity
- 0.750 [*19.05*] spacing opposing polarity
- Torque specification: 27 ±3 in-lb.

### Style 10 (15 & 30A)

- PHOENIX CONTACT\* part number: VDFK4
- Accepts 12 AWG stranded wire
- Wire strip length: 0.315 [*8.0*]
- Torque specification: 5.5 – 7.0 in-lb.
- Ground stud: 8-32

### Style 10 (100A)

- PHOENIX CONTACT\* part number: HDFK 25-VP
- Accepts 4 AWG stranded wire
- Wire strip length: 0.748 [*19.0*]
- Torque specification: 35.4 – 39.9 in-lb.
- Ground stud: 1/4-20

### Style 6 (100 & 125A)

- Supplied with 1/4-20 redundant studs
- 0.750 [*19.05*] spacing like polarity
- 1.00 [*25.4*] spacing opposing polarity
- Torque specification: 45 ±2 in-lb

### Style 10 (60A)

- PHOENIX CONTACT\* part number: HDFK 16-VP
- Accepts 6 AWG stranded wire
- Wire strip length: 0.630 [*16.0*]
- Torque specification: 17.7 – 21.2 in-lb.
- Ground stud: 10-32

### Style 10 (125A)

- PHOENIX CONTACT\* part number: HDFK 50-VP
- Accepts 1 AWG stranded wire
- Wire strip length: 0.945 [*24.0*]
- Torque specification: 35.4 – 39.9 in-lb.
- Ground stud: 1/4-20

\*PHOENIX CONTACT is a trademark of Phoenix Contact GmbH & Co. KG.

**RFI Power Line Filters for DC Applications** *(continued)*

# DC Series

## Recommended Panel Cutouts

### DCB6(F) & DCB10(F)



### DCB6B(F) & DCB10B(F) 15 to 60A



### DCB6B(F) & DCB10B(F) 100 to 125A

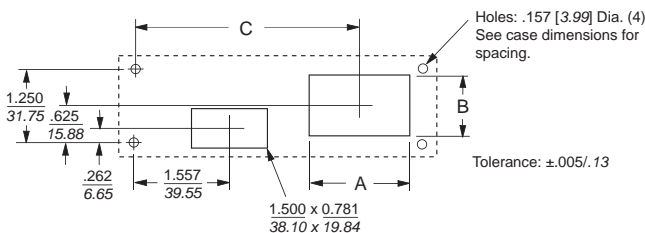

## Cutout Dimensions

### DCB6(F) & DCB10(F)

Part No.	A	B	C
15DCB6(F)	<b>1.375</b>	<b>1.249</b>	<b>3.472</b>
30DCB6(F)	34.93	31.72	88.19
15DCB10(F)	<b>1.250</b>	<b>1.000</b>	<b>3.472</b>
30DCB10(F)	31.75	25.40	88.19
60DCB6(F)	<b>1.375</b>	<b>1.249</b>	<b>3.472</b>
	34.93	31.72	88.19
60DCB10(F)	<b>1.674</b>	<b>1.010</b>	<b>3.443</b>
	42.52	25.65	87.45
100DCB6(F)	<b>1.700</b>	<b>1.549</b>	<b>3.472</b>
125DCB6(F)	43.18	39.34	88.19
100DCB10(F)	<b>1.954</b>	<b>1.500</b>	<b>2.830</b>
	49.63	38.10	71.20
125DCB10(F)	<b>2.250</b>	<b>1.590</b>	<b>2.725</b>
	57.15	40.39	69.22

### DCB6B(F) & DCB10B(F) 15 to 60A

Part No.	A	B	C	D	E	F
15DCB6B(F)	<b>1.50</b>	<b>0.781</b>	<b>1.308</b>	<b>3.472</b>	<b>1.375</b>	<b>1.249</b>
15DCF6B	38.10	19.84	33.22	88.19	34.93	31.72
15DCB10B(F)	<b>1.50</b>	<b>0.781</b>	<b>1.308</b>	<b>3.472</b>	<b>1.250</b>	<b>1.00</b>
15DCF10B	38.10	19.84	33.22	88.19	31.75	25.40
30DCB6B(F)	<b>1.50</b>	<b>0.781</b>	<b>1.308</b>	<b>3.472</b>	<b>1.375</b>	<b>1.249</b>
30DCF6B	38.10	19.84	33.22	88.19	34.93	31.72
30DCB10B(F)	<b>1.50</b>	<b>0.781</b>	<b>1.308</b>	<b>3.472</b>	<b>1.250</b>	<b>1.00</b>
30DCF10B	38.10	19.84	33.22	88.19	31.75	25.40
60DCB10B(F)	<b>1.50</b>	<b>0.781</b>	<b>1.308</b>	<b>3.443</b>	<b>1.674</b>	<b>1.010</b>
60DCF10B	38.10	19.84	33.22	87.45	42.52	25.65
60DCF6B(F)	<b>1.50</b>	<b>0.781</b>	<b>1.308</b>	<b>3.472</b>	<b>1.375</b>	<b>1.249</b>
60DCF6B	38.10	19.84	33.22	88.19	34.93	31.72

### DCB6B(F) & DCB10B(F) 100 to 125A

Part No.	A	B	C
100DCB6B(F)	<b>1.70</b>	<b>1.549</b>	<b>4.222</b>
100DCF6B			
125DCB6B(F)	43.18	39.34	107.23
125DCF6B			
100DCB10B(F)	<b>1.954</b>	<b>1.50</b>	<b>4.295</b>
100DCF10B	49.63	38.10	109.09
125DCB10B(F)	<b>2.25</b>	<b>1.59</b>	<b>4.147</b>
	57.15	40.39	105.33
125DCF10B	<b>2.25</b>	<b>1.59</b>	<b>2.725</b>
	57.15	40.39	105.33

RFI Power Line Filters for DC Applications *(continued)*

# DC Series

## Case Styles

### DCB6 & DCB6B



### DCB10 & DCB10B (60 to 125A)



### DCF6

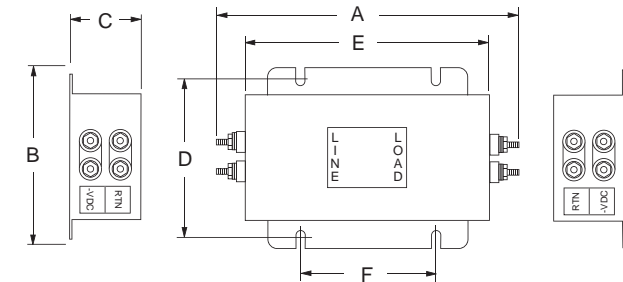

Typical Dimensions:  
Mounting Slots (4): .260 x .39 [6.6 x 9.9] 60 to 125A versions  
Mounting Holes (4): .203 x .156 [5.2 x 4.0] 15 & 30A versions

### DCF10 (15 & 30A)

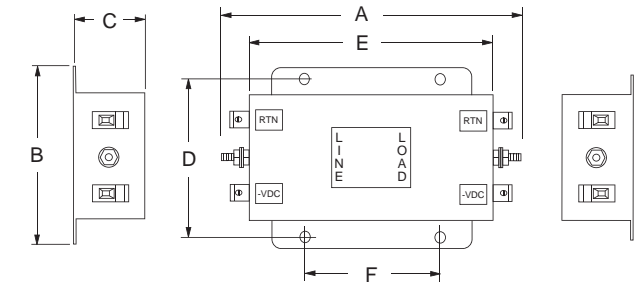

Typical Dimensions:  
Mounting Holes (4): .203 x .156 [5.2 x 4.0]

### DCF6B

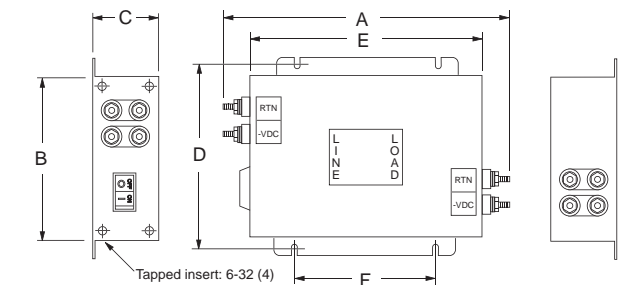

Typical Dimensions:  
Mounting Slots (4): .260 x .39 [6.6 x 9.9]

### DCF10 (60 to 125A)

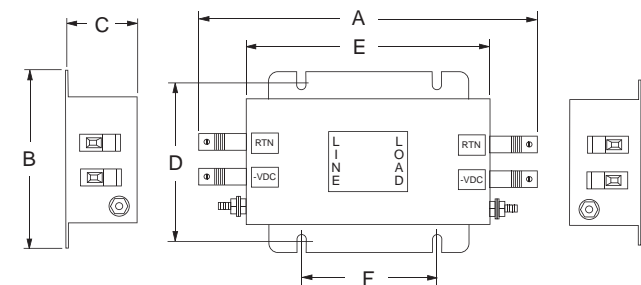

Typical Dimensions:  
Mounting Slots (4): .260 x .39 [6.6 x 9.9]

### DCB10 & DCB10B (15 to 30A)

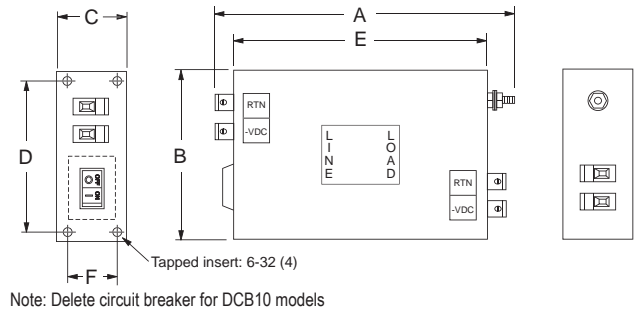

### DCF10B (15 & 30A)

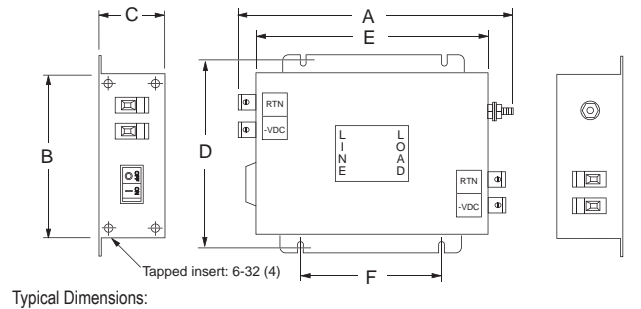

Typical Dimensions:  
Mounting Slots (4): .260 x .39 [6.6 x 9.9]

**RFI Power Line Filters for DC Applications** *(continued)*

# DC Series

**Case Styles** *(continued)*

**DCF10B (60 TO 125A)**



Typical Dimensions:  
Mounting Slots (4): .260 x .39 [6.6 x 9.9]

**Case Dimensions**

Part No.	A (max)	B (max)	C (max)	D $\pm 0.20$ $\pm .51$	E (max)	F $\pm 0.20$ $\pm .51$
15DCB6(F)	<b>5.69</b> 144.5	<b>5.06</b> 128.5	<b>1.48</b> 37.6	<b>4.50</b> 114.3	<b>4.06</b> 103.1	<b>0.950</b> 24.13
15DCB6B(F)	<b>7.69</b> 195.3	<b>5.06</b> 128.5	<b>1.48</b> 37.6	<b>4.50</b> 114.3	<b>6.06</b> 153.9	<b>0.950</b> 24.13
15DCB10(F)	<b>5.06</b> 128.5	<b>5.06</b> 128.5	<b>1.48</b> 37.6	<b>4.50</b> 114.3	<b>4.06</b> 103.1	<b>0.950</b> 24.13
15DCB10B(F)	<b>7.06</b> 179.3	<b>5.06</b> 128.5	<b>1.48</b> 37.6	<b>4.50</b> 114.3	<b>6.06</b> 153.9	<b>0.950</b> 24.13
15DCF6	<b>5.33</b> 135.4	<b>3.10</b> 78.7	<b>1.78</b> 45.2	<b>2.677</b> 68.0	<b>3.70</b> 94.0	<b>2.00</b> 50.80
15DCF6B(F)	<b>7.69</b> 195.3	<b>5.06</b> 128.5	<b>1.48</b> 37.6	<b>5.740</b> 145.8	<b>6.06</b> 153.9	<b>3.52</b> 89.41
15DCF10	<b>4.75</b> 120.7	<b>3.10</b> 78.7	<b>1.78</b> 45.2	<b>2.677</b> 68.0	<b>3.70</b> 94.0	<b>2.0</b> 50.8
15DCF10B(F)	<b>7.06</b> 179.3	<b>5.06</b> 128.5	<b>1.48</b> 37.6	<b>5.740</b> 145.80	<b>6.06</b> 153.9	<b>3.520</b> 89.41
30DCB6(F)	<b>7.69</b> 195.3	<b>5.06</b> 128.5	<b>1.48</b> 37.6	<b>4.50</b> 114.3	<b>6.06</b> 153.9	<b>0.95</b> 24.13
30DCB6B(F)	<b>8.69</b> 220.7	<b>5.06</b> 128.5	<b>1.48</b> 37.6	<b>4.50</b> 114.3	<b>7.06</b> 179.3	<b>0.95</b> 24.13
30DCB10(F)	<b>7.06</b> 179.3	<b>5.06</b> 128.5	<b>1.48</b> 37.6	<b>4.50</b> 114.3	<b>6.06</b> 153.9	<b>0.95</b> 24.13
30DCB10B(F)	<b>8.06</b> 204.7	<b>5.06</b> 128.5	<b>1.48</b> 37.6	<b>4.50</b> 114.3	<b>7.06</b> 179.3	<b>0.95</b> 24.13
30DCF6	<b>6.19</b> 157.2	<b>3.96</b> 100.6	<b>2.18</b> 55.4	<b>3.50</b> 88.9	<b>4.56</b> 115.8	<b>2.00</b> 50.8
30DCF6B	<b>8.69</b> 220.73	<b>5.0</b> 127.0	<b>1.48</b> 37.6	<b>5.74</b> 145.8	<b>7.06</b> 179.3	<b>4.52</b> 114.81
30DCF10	<b>5.56</b> 141.2	<b>3.96</b> 100.58	<b>2.18</b> 55.4	<b>3.5</b> 88.9	<b>4.56</b> 115.8	<b>2.0</b> 50.8
30DCF10B	<b>8.06</b> 204.7	<b>5.06</b> 128.52	<b>1.48</b> 37.6	<b>5.74</b> 145.8	<b>7.06</b> 179.3	<b>4.52</b> 114.81

**Case Dimensions** *(continued)*

Part No.	A (max)	B (max)	C (max)	D $\pm 0.20$ $\pm .51$	E (max)	F $\pm 0.20$ $\pm .51$
60DCB6(F)	<b>8.69</b> 220.73	<b>5.06</b> 128.52	<b>1.48</b> 37.6	<b>4.50</b> 114.3	<b>7.06</b> 179.3	<b>0.95</b> 24.13
60DCB6B(F)	<b>10.69</b> 271.5	<b>5.06</b> 128.52	<b>1.48</b> 37.6	<b>4.50</b> 114.3	<b>9.06</b> 230.1	<b>0.95</b> 24.13
60DCF6	<b>7.56</b> 192.0	<b>5.48</b> 139.2	<b>2.55</b> 64.8	<b>4.92</b> 124.97	<b>5.94</b> 150.9	<b>2.756</b> 70.0
60DCF6B	<b>10.69</b> 271.5	<b>5.06</b> 128.52	<b>1.48</b> 37.6	<b>5.74</b> 145.8	<b>9.06</b> 230.1	<b>6.52</b> 165.61
60DCF10	<b>8.56</b> 217.4	<b>5.48</b> 139.2	<b>2.55</b> 64.8	<b>4.92</b> 124.97	<b>5.94</b> 150.9	<b>2.576</b> 65.43
60DCF10B	<b>11.75</b> 298.5	<b>5.06</b> 128.5	<b>1.48</b> 37.6	<b>5.74</b> 145.8	<b>9.06</b> 230.1	<b>6.52</b> 165.61
100DCB6(F)	<b>10.31</b> 261.9	<b>5.06</b> 128.5	<b>1.78</b> 45.2	<b>4.50</b> 114.3	<b>8.06</b> 204.7	<b>1.25</b> 31.75
100DCB6B(F)	<b>12.31</b> 312.7	<b>6.06</b> 153.9	<b>1.78</b> 45.2	<b>5.50</b> 139.7	<b>10.06</b> 255.5	<b>1.25</b> 31.75
100DCB10(F)	<b>11.13</b> 282.6	<b>5.06</b> 128.5	<b>1.78</b> 45.2	<b>4.50</b> 114.3	<b>8.06</b> 204.7	<b>1.25</b> 31.75
100DCB10B(F)	<b>13.13</b> 333.5	<b>6.06</b> 153.9	<b>1.78</b> 45.2	<b>5.50</b> 139.7	<b>10.06</b> 255.5	<b>1.25</b> 31.75
100DCF6	<b>10.60</b> 269.2	<b>6.30</b> 160.0	<b>2.52</b> 64.0	<b>5.70</b> 144.78	<b>8.46</b> 214.9	<b>4.52</b> 114.81
100DCF6B	<b>12.31</b> 312.7	<b>6.06</b> 153.9	<b>1.78</b> 45.2	<b>6.74</b> 171.2	<b>10.06</b> 255.5	<b>7.52</b> 191.01
100DCF10	<b>11.50</b> 292.1	<b>6.30</b> 160.0	<b>2.52</b> 64.0	<b>5.70</b> 144.78	<b>8.46</b> 214.9	<b>4.52</b> 114.81
100DCF10B	<b>13.13</b> 333.5	<b>6.06</b> 153.9	<b>1.78</b> 45.2	<b>6.74</b> 171.2	<b>10.06</b> 255.5	<b>7.52</b> 191.01
125DCB6(F)	<b>10.31</b> 261.9	<b>5.06</b> 128.5	<b>1.78</b> 45.2	<b>4.50</b> 114.3	<b>8.06</b> 204.7	<b>1.25</b> 31.75
125DCB6B(F)	<b>12.31</b> 312.7	<b>6.06</b> 153.9	<b>1.78</b> 45.2	<b>5.50</b> 139.7	<b>10.06</b> 255.5	<b>1.25</b> 31.75
125DCB10(F)	<b>11.50</b> 292.1	<b>5.06</b> 128.5	<b>1.78</b> 45.2	<b>4.50</b> 114.30	<b>8.06</b> 204.7	<b>1.25</b> 31.75
125DCB10B(F)	<b>13.50</b> 342.9	<b>6.06</b> 153.9	<b>1.78</b> 45.2	<b>5.50</b> 139.7	<b>10.06</b> 255.5	<b>1.25</b> 31.75
125DCF6	<b>10.60</b> 269.2	<b>6.30</b> 160.0	<b>2.52</b> 64.0	<b>5.70</b> 144.78	<b>8.46</b> 214.9	<b>4.52</b> 114.81
125DCF6B	<b>12.31</b> 312.7	<b>6.06</b> 153.9	<b>1.78</b> 45.2	<b>6.74</b> 171.2	<b>10.06</b> 255.5	<b>7.52</b> 191.01
125DCF10	<b>11.86</b> 301.2	<b>6.30</b> 160.0	<b>2.52</b> 64.0	<b>5.70</b> 144.78	<b>8.46</b> 214.9	<b>4.52</b> 114.81
125DCF10B	<b>13.50</b> 342.9	<b>6.06</b> 153.9	<b>1.78</b> 45.2	<b>6.74</b> 171.2	<b>10.06</b> 255.5	<b>7.52</b> 191.01

4  
DC Filters

Dimensions are in inches and millimeters unless otherwise specified. Values in italics are metric equivalents. Dimensions are shown for reference purposes only. Specifications subject to change.

For email, phone or live chat, please go to [te.com/help](http://te.com/help)  
[corcom.com](http://corcom.com)

**RFI Power Line Filters for DC Applications** *(continued)*

# DC Series

## Performance Data *(continued)*

### Minimum Insertion Loss

Measured in closed 50 Ohm system

### Standard Performance

Common Mode / Asymmetrical (Line to Ground)

Current Rating	Frequency – MHz									
	.01	.05	.1	.15	.5	1	3	5	10	30
15A	-	1	12	20	41	45	61	63	47	39
30A	-	4	15	23	47	59	64	56	44	36
60A	-	-	9	17	38	40	59	50	39	34
100A	-	-	10	18	38	39	53	50	35	21
125A	-	-	12	18	30	32	44	49	29	18

Differential Mode / Symmetrical (Line to Line)

Current Rating	Frequency – MHz									
	.01	.05	.1	.15	.5	1	3	5	10	30
15A	7	22	27	30	30	36	56	49	38	31
30A	7	22	28	31	32	59	56	51	41	28
60A	15	30	36	40	40	35	60	51	39	32
100A	14	29	35	39	33	30	53	53	41	30
125A	14	24	35	39	40	28	53	60	42	33

### High Frequency Performance (F & BF Styles)

Common Mode / Asymmetrical (Line to Ground)

Current Rating	Frequency – MHz											
	.01	.05	.1	.15	.5	1	3	5	10	20	300	3000
15A	-	1	12	20	41	45	55	50	45	25	50	30
30A	-	4	15	20	46	58	60	60	48	35	50	30
60A	-	-	9	16	38	42	52	60	48	26	40	30
100A	-	-	9	16	38	42	52	60	42	26	40	30
125A	-	-	9	16	28	34	46	54	34	34	40	30

Differential Mode / Symmetrical (Line to Line)

Current Rating	Frequency – MHz									
	.01	.05	.1	.15	.5	1	3	5	10	20
15A	7	22	27	30	30	50	60	60	60	36
30A	7	22	27	30	33	56	60	60	60	40
60A	15	30	36	40	37	26	46	54	48	30
100A	14	29	35	39	33	30	56	53	41	30
125A	14	29	35	39	40	28	53	60	42	33