

IRG4PC40FDPbF

INSULATED GATE BIPOLAR TRANSISTOR WITH
ULTRAFAST SOFT RECOVERY DIODE

Fast CoPack IGBT

Features

- Fast: Optimized for medium operating frequencies (1-5 kHz in hard switching, >20 kHz in resonant mode).
- Generation 4 IGBT design provides tighter parameter distribution and higher efficiency than Generation 3
- IGBT co-packaged with HEXFRED™ ultrafast, ultra-soft-recovery anti-parallel diodes for use in bridge configurations
- Industry standard TO-247AC package
- Lead-Free

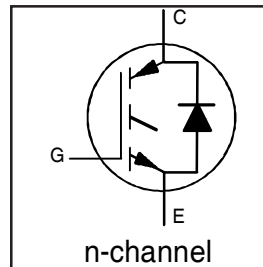

| |
|-----------------------------|
| $V_{CES} = 600V$ |
| $V_{CE(on) typ.} = 1.50V$ |
| @ $V_{GE} = 15V, I_C = 27A$ |

Benefits

- Generation -4 IGBT's offer highest efficiencies available
- IGBT's optimized for specific application conditions
- HEXFRED diodes optimized for performance with IGBT's . Minimized recovery characteristics require less/no snubbing
- Designed to be a "drop-in" replacement for equivalent industry-standard Generation 3 IR IGBT's

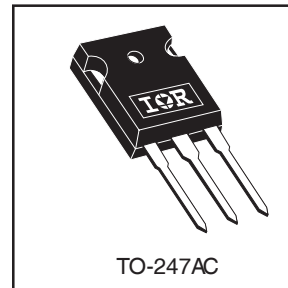

Absolute Maximum Ratings

| | Parameter | Max. | Units |
|---------------------------|--|---------------------|------------|
| V_{CES} | Collector-to-Emitter Voltage | 600 | V |
| $I_C @ T_C = 25^\circ C$ | Continuous Collector Current | 49 | A |
| $I_C @ T_C = 100^\circ C$ | Continuous Collector Current | 27 | |
| I_{CM} | Pulsed Collector Current ① | 196 | |
| I_{LM} | Clamped Inductive Load Current ② | 196 | |
| $I_F @ T_C = 100^\circ C$ | Diode Continuous Forward Current | 15 | |
| I_{FM} | Diode Maximum Forward Current | 200 | |
| V_{GE} | Gate-to-Emitter Voltage | ± 20 | V |
| $P_D @ T_C = 25^\circ C$ | Maximum Power Dissipation | 160 | W |
| $P_D @ T_C = 100^\circ C$ | Maximum Power Dissipation | 65 | |
| T_J | Operating Junction and Storage Temperature Range | -55 to +150 | $^\circ C$ |
| T_{STG} | | | |
| | | | |
| | Mounting Torque, 6-32 or M3 Screw. | 10 lbf•in (1.1 N•m) | |

Thermal Resistance

| | Parameter | Min. | Typ. | Max. | Units |
|-----------------|---|-------|----------|-------|--------------|
| $R_{\theta JC}$ | Junction-to-Case - IGBT | ----- | ----- | 0.77 | $^\circ C/W$ |
| $R_{\theta JC}$ | Junction-to-Case - Diode | ----- | ----- | 1.7 | |
| $R_{\theta CS}$ | Case-to-Sink, flat, greased surface | ----- | 0.24 | ----- | |
| $R_{\theta JA}$ | Junction-to-Ambient, typical socket mount | ----- | ----- | 40 | |
| Wt | Weight | ----- | 6 (0.21) | ----- | g (oz) |

Electrical Characteristics @ T_J = 25°C (unless otherwise specified)

| | Parameter | Min. | Typ. | Max. | Units | Conditions |
|--|---|------|------|------|-------|--|
| V _{(BR)CES} | Collector-to-Emitter Breakdown Voltage ^③ | 600 | ---- | ---- | V | V _{GE} = 0V, I _C = 250μA |
| ΔV _{(BR)CES} /ΔT _J | Temperature Coeff. of Breakdown Voltage | ---- | 0.70 | ---- | V/°C | V _{GE} = 0V, I _C = 1.0mA |
| V _{CE(on)} | Collector-to-Emitter Saturation Voltage | ---- | 1.50 | 1.7 | V | I _C = 27A V _{GE} = 15V |
| | | ---- | 1.85 | ---- | | I _C = 49A See Fig. 2, 5 |
| | | ---- | 1.56 | ---- | | I _C = 27A, T _J = 150°C |
| V _{GE(th)} | Gate Threshold Voltage | 3.0 | ---- | 6.0 | | V _{CE} = V _{GE} , I _C = 250μA |
| ΔV _{GE(th)} /ΔT _J | Temperature Coeff. of Threshold Voltage | ---- | -12 | ---- | mV/°C | V _{CE} = V _{GE} , I _C = 250μA |
| g _{fe} | Forward Transconductance ^④ | 9.2 | 12 | ---- | S | V _{CE} = 100V, I _C = 27A |
| I _{CES} | Zero Gate Voltage Collector Current | ---- | ---- | 250 | μA | V _{GE} = 0V, V _{CE} = 600V |
| | | ---- | ---- | 3500 | | V _{GE} = 0V, V _{CE} = 600V, T _J = 150°C |
| V _{FM} | Diode Forward Voltage Drop | ---- | 1.3 | 1.7 | V | I _C = 15A See Fig. 13 |
| | | ---- | 1.2 | 1.6 | | I _C = 15A, T _J = 150°C |
| I _{GES} | Gate-to-Emitter Leakage Current | ---- | ---- | ±100 | nA | V _{GE} = ±20V |

Switching Characteristics @ T_J = 25°C (unless otherwise specified)

| | Parameter | Min. | Typ. | Max. | Units | Conditions |
|--------------------------|---|------|------|------|-------|--|
| Q _g | Total Gate Charge (turn-on) | ---- | 100 | 150 | nC | I _C = 27A |
| Q _{ge} | Gate - Emitter Charge (turn-on) | ---- | 15 | 23 | | V _{CC} = 400V See Fig. 8 |
| Q _{gc} | Gate - Collector Charge (turn-on) | ---- | 35 | 53 | | V _{GE} = 15V |
| t _{d(on)} | Turn-On Delay Time | ---- | 63 | ---- | ns | T _J = 25°C |
| t _r | Rise Time | ---- | 32 | ---- | | I _C = 27A, V _{CC} = 480V |
| t _{d(off)} | Turn-Off Delay Time | ---- | 230 | 350 | mJ | V _{GE} = 15V, R _G = 10Ω |
| t _f | Fall Time | ---- | 170 | 250 | | Energy losses include "tail" and diode reverse recovery. |
| E _{on} | Turn-On Switching Loss | ---- | 0.95 | ---- | mJ | See Fig. 9, 10, 11, 18 |
| E _{off} | Turn-Off Switching Loss | ---- | 2.01 | ---- | | |
| E _{ts} | Total Switching Loss | ---- | 2.96 | 4.0 | | |
| t _{d(on)} | Turn-On Delay Time | ---- | 63 | ---- | ns | T _J = 150°C, See Fig. 9, 10, 11, 18 |
| t _r | Rise Time | ---- | 33 | ---- | | I _C = 27A, V _{CC} = 480V |
| t _{d(off)} | Turn-Off Delay Time | ---- | 350 | ---- | | V _{GE} = 15V, R _G = 10Ω |
| t _f | Fall Time | ---- | 310 | ---- | | Energy losses include "tail" and diode reverse recovery. |
| E _{ts} | Total Switching Loss | ---- | 4.7 | ---- | mJ | |
| L _E | Internal Emitter Inductance | ---- | 13 | ---- | nH | Measured 5mm from package |
| C _{ies} | Input Capacitance | ---- | 2200 | ---- | pF | V _{GE} = 0V |
| C _{oes} | Output Capacitance | ---- | 140 | ---- | | V _{CC} = 30V See Fig. 7 |
| C _{res} | Reverse Transfer Capacitance | ---- | 29 | ---- | | f = 1.0MHz |
| t _{rr} | Diode Reverse Recovery Time | ---- | 42 | 60 | ns | T _J = 25°C See Fig. 14 |
| | | ---- | 74 | 120 | | T _J = 125°C |
| I _{rr} | Diode Peak Reverse Recovery Current | ---- | 4.0 | 6.0 | A | T _J = 25°C See Fig. 15 |
| | | ---- | 6.5 | 10 | | T _J = 125°C |
| Q _{rr} | Diode Reverse Recovery Charge | ---- | 80 | 180 | nC | T _J = 25°C See Fig. 16 |
| | | ---- | 220 | 600 | | T _J = 125°C |
| di _(rec) M/dt | Diode Peak Rate of Fall of Recovery During t _b | ---- | 188 | ---- | A/μs | T _J = 25°C See Fig. 17 |
| | | ---- | 160 | ---- | | T _J = 125°C |

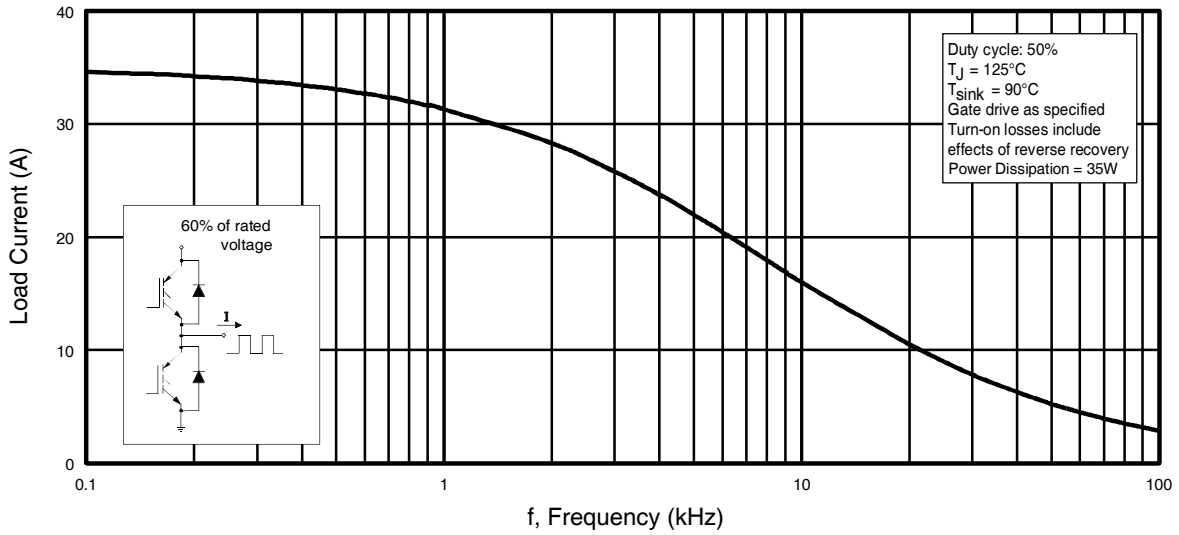

Fig. 1 - Typical Load Current vs. Frequency
(Load Current = I_{RMS} of fundamental)

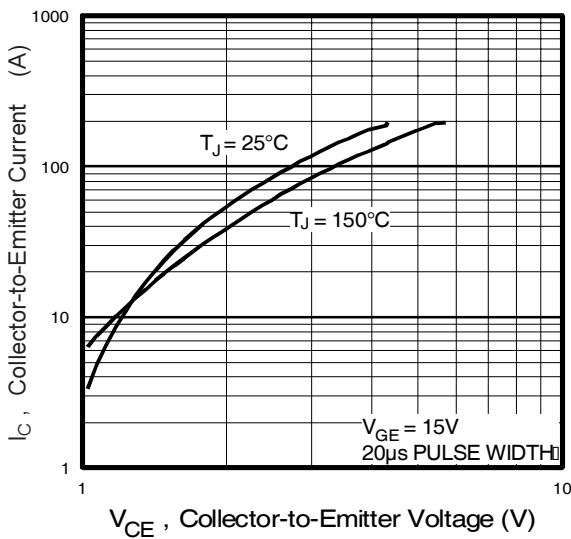

Fig. 2 - Typical Output Characteristics

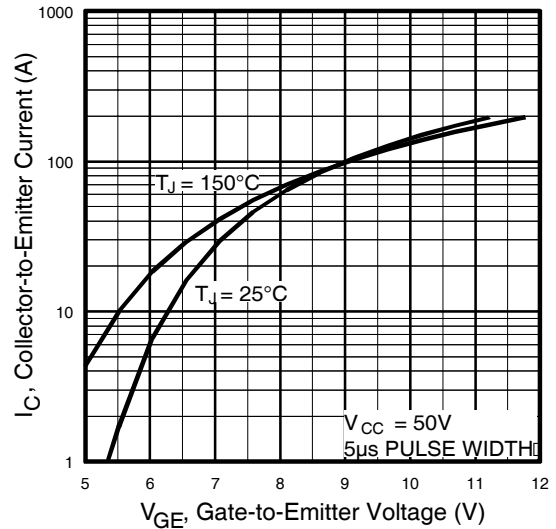

Fig. 3 - Typical Transfer Characteristics

IRG4PC40FDPbF

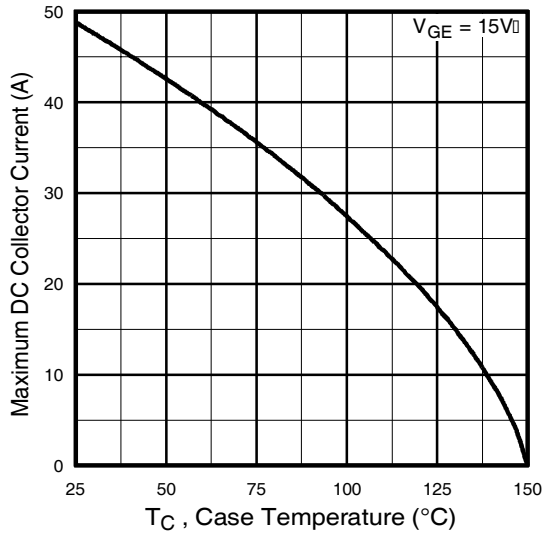

Fig. 4 - Maximum Collector Current vs. Case Temperature

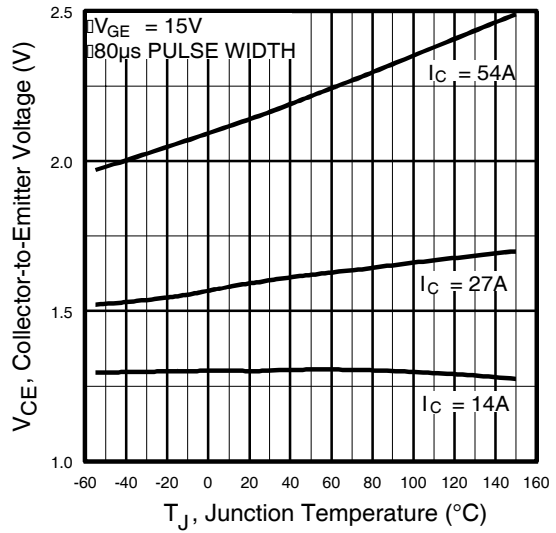

Fig. 5 - Typical Collector-to-Emitter Voltage vs. Junction Temperature

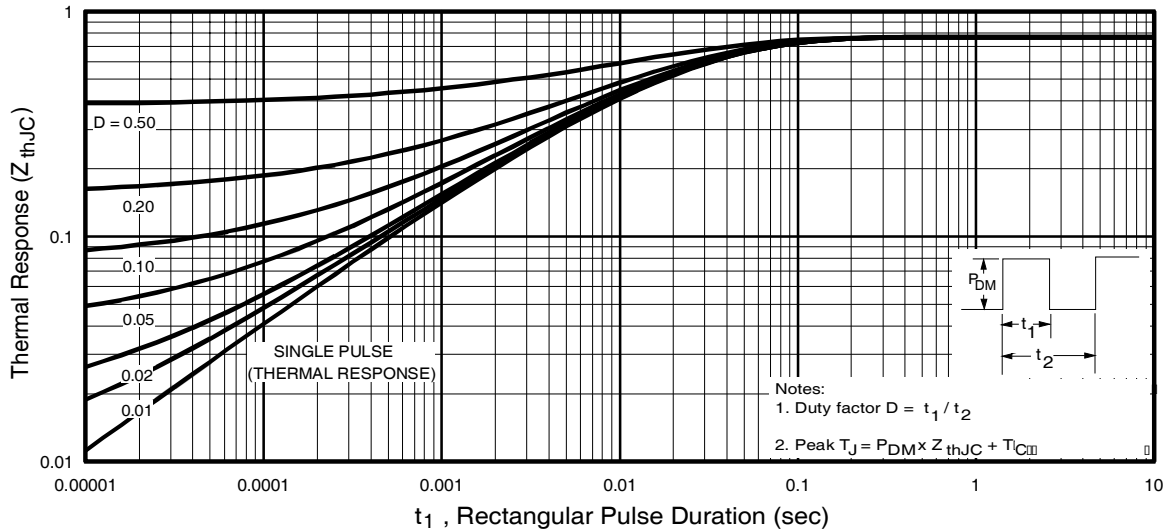

Fig. 6 - Maximum Effective Transient Thermal Impedance, Junction-to-Case

IRG4PC40FDPbF

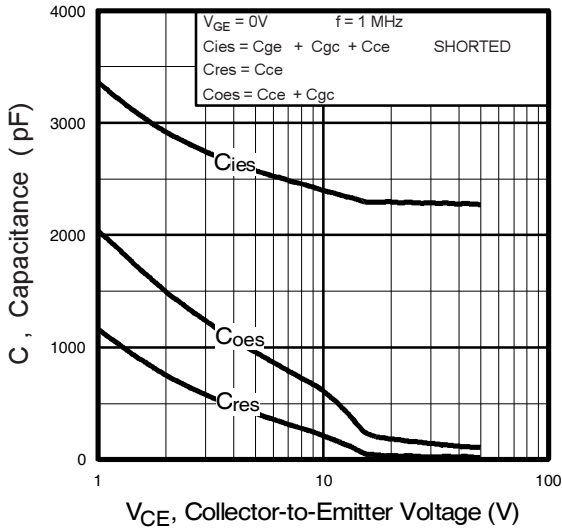

Fig. 7 - Typical Capacitance vs. Collector-to-Emitter Voltage

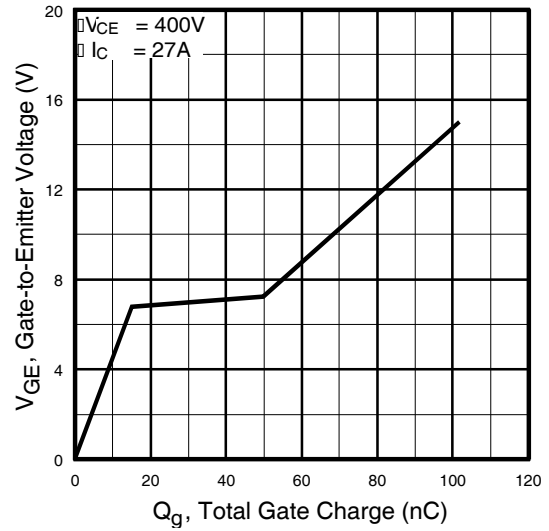

Fig. 8 - Typical Gate Charge vs. Gate-to-Emitter Voltage

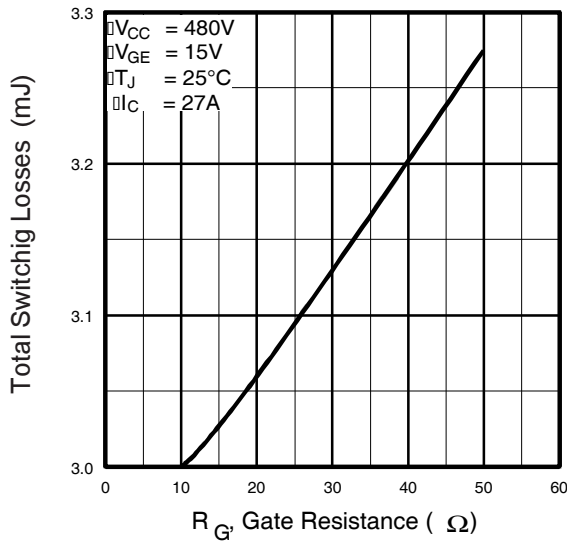

Fig. 9 - Typical Switching Losses vs. Gate Resistance

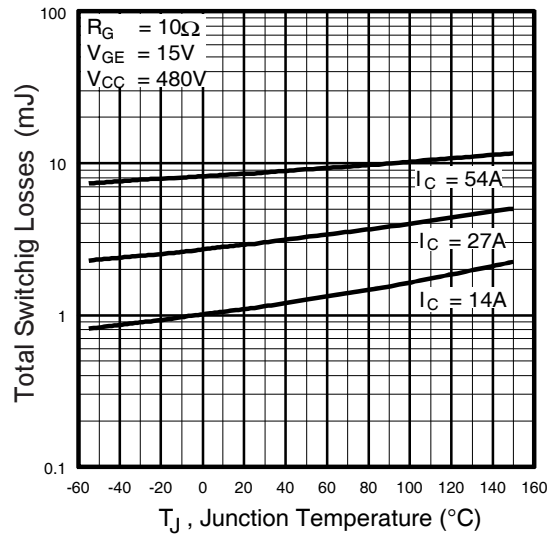

Fig. 10 - Typical Switching Losses vs. Junction Temperature

IRG4PC40FDPbF

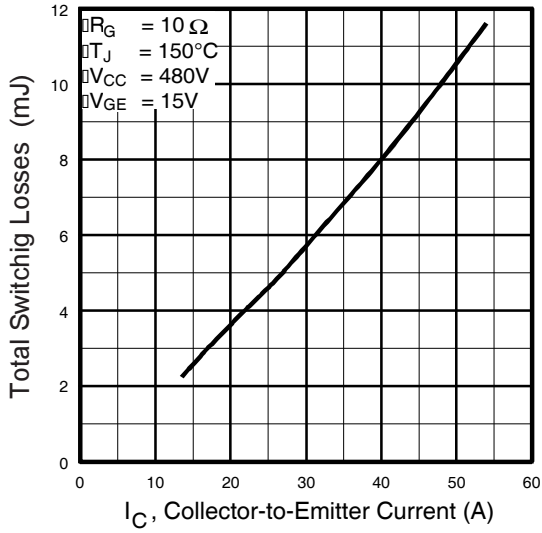

Fig. 11 - Typical Switching Losses vs. Collector-to-Emitter Current

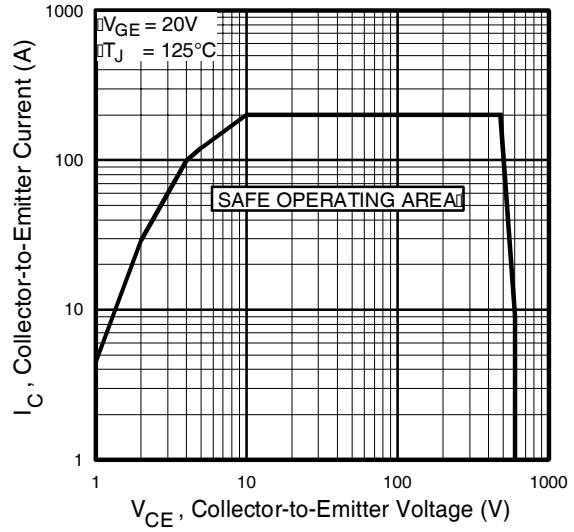

Fig. 12 - Turn-Off SOA

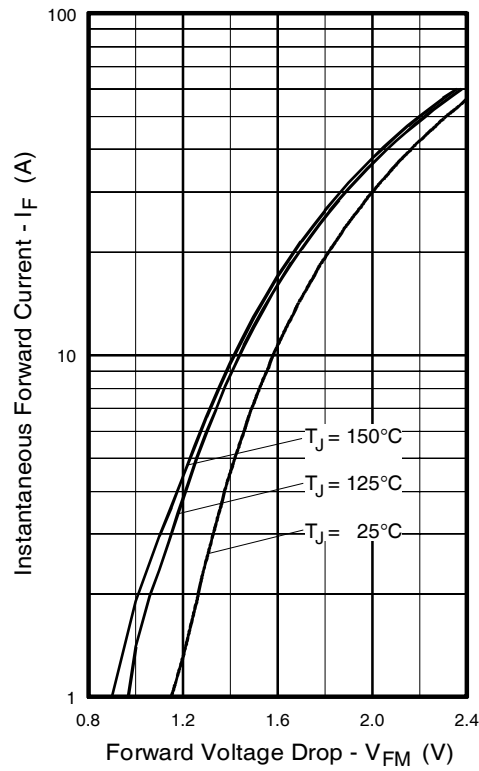

Fig. 13 - Maximum Forward Voltage Drop vs. Instantaneous Forward Current

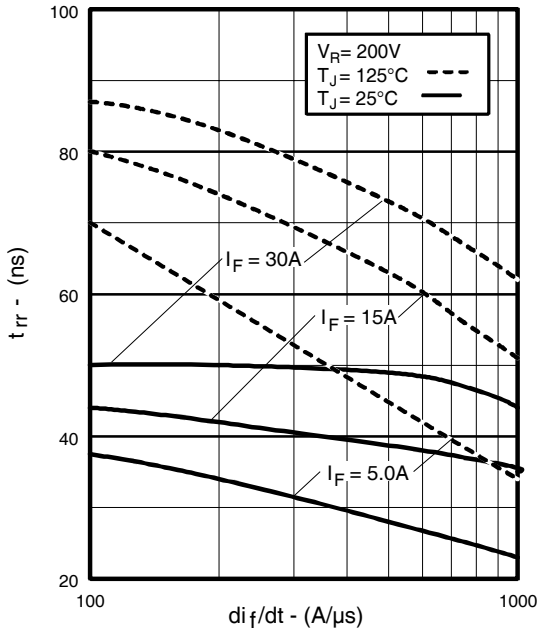

Fig. 14 - Typical Reverse Recovery vs. di_f/dt

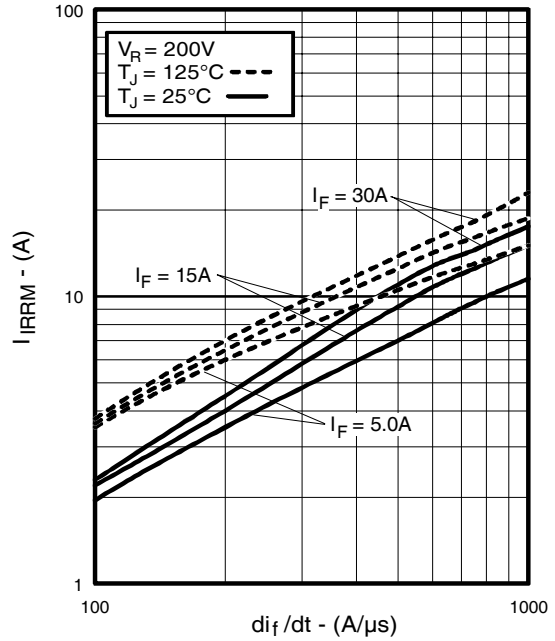

Fig. 15 - Typical Recovery Current vs. di_f/dt

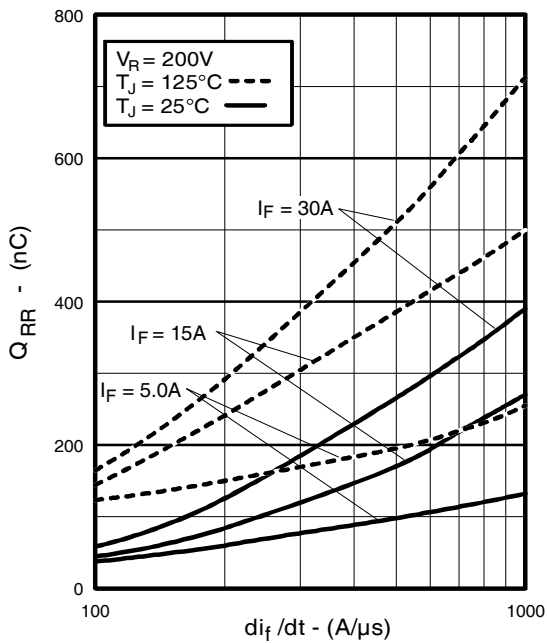

Fig. 16 - Typical Stored Charge vs. di_f/dt

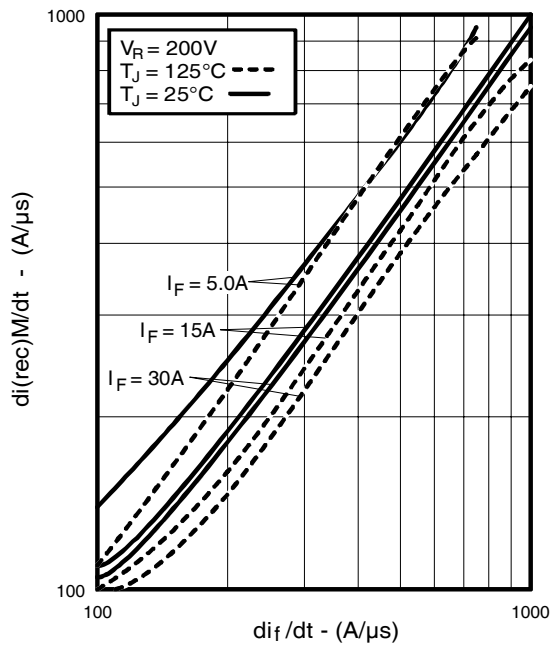

Fig. 17 - Typical $di_{(rec)M}/dt$ vs. di_f/dt

IRG4PC40FDPbF

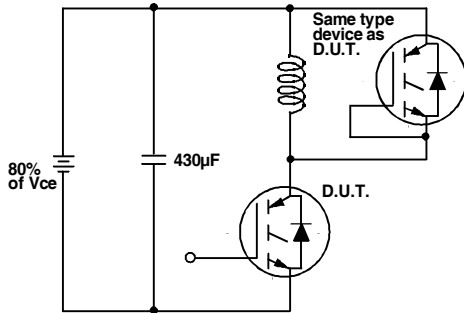

Fig. 18a - Test Circuit for Measurement of I_{LM} , E_{on} , $E_{off}(\text{diode})$, t_{rr} , Q_{rr} , I_{rr} , $t_{d(on)}$, t_r , $t_{d(off)}$, t_f

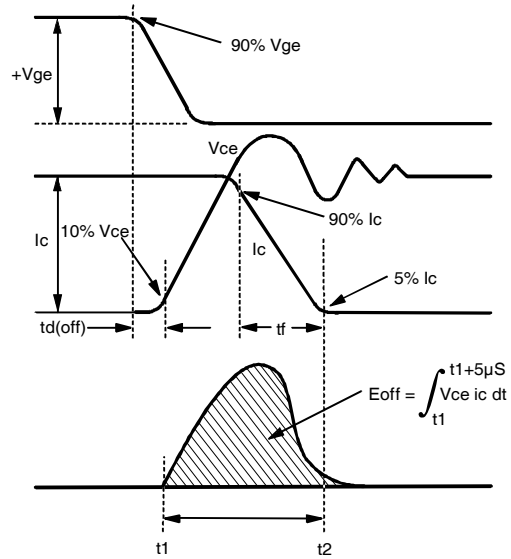

Fig. 18b - Test Waveforms for Circuit of Fig. 18a, Defining E_{off} , $t_{d(off)}$, t_f

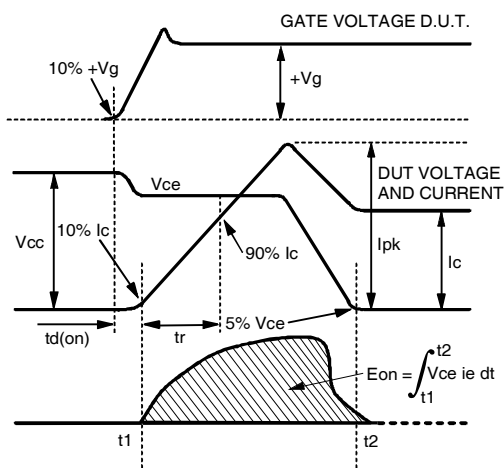

Fig. 18c - Test Waveforms for Circuit of Fig. 18a, Defining E_{on} , $t_{d(on)}$, t_r

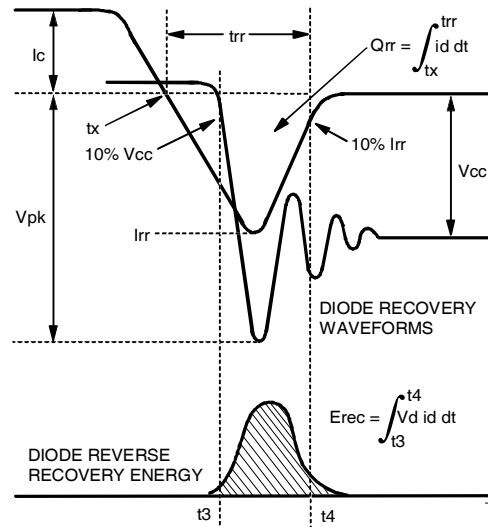

Fig. 18d - Test Waveforms for Circuit of Fig. 18a, Defining E_{rec} , t_{rr} , Q_{rr} , I_{rr}

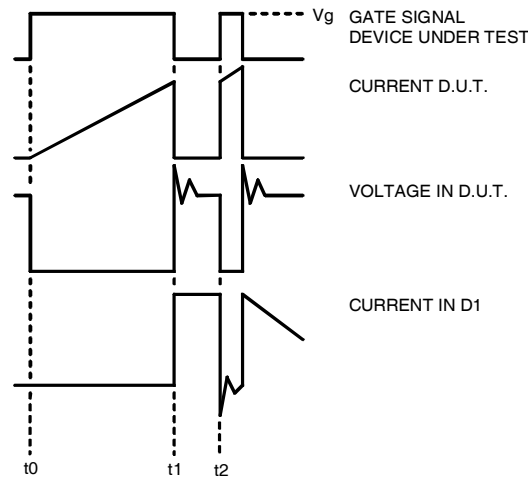

Figure 18e. Macro Waveforms for Figure 18a's Test Circuit

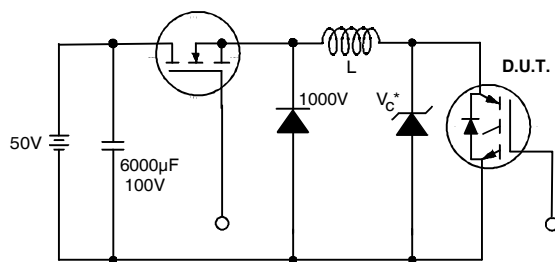

Figure 19. Clamped Inductive Load Test Circuit

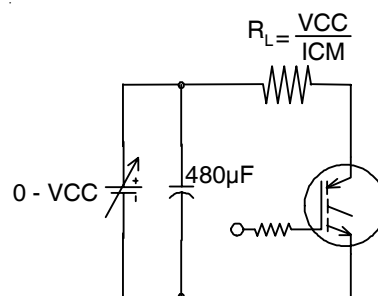

Figure 20. Pulsed Collector Current Test Circuit

IRG4PC40FDPbF



TO-247AC Package Outline

Dimensions are shown in millimeters (inches)

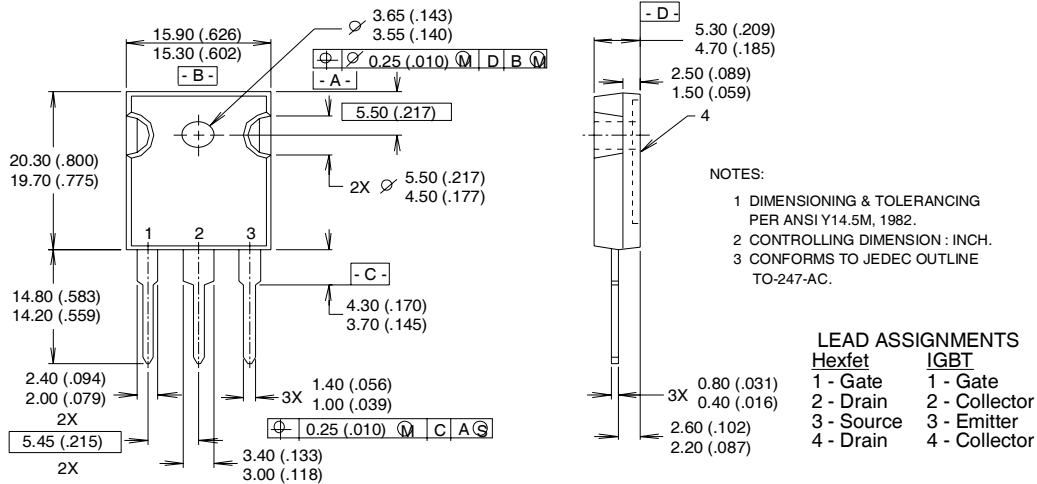

TO-247AC Part Marking Information

EXAMPLE: THIS IS AN IRFPE30 WITH ASSEMBLY LOT CODE 5657 ASSEMBLED ON WW 35, 2000 IN THE ASSEMBLY LINE 'H'
Note: "P" in assembly line position indicates "Lead-Free"

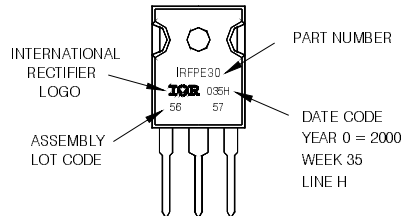

Note: For the most current drawing please refer to IR website at <http://www.irf.com/package/>

Notes:

- ① Repetitive rating: $V_{GE}=20V$; pulse width limited by maximum junction temperature (figure 20)
- ② $V_{CC}=80\%(V_{CES})$, $V_{GE}=20V$, $L=10\mu H$, $R_G = 10\Omega$ (figure 19)
- ③ Pulse width $\leq 80\mu s$; duty factor $\leq 0.1\%$.
- ④ Pulse width $5.0\mu s$, single shot.

Data and specifications subject to change without notice.



IR WORLD HEADQUARTERS: 233 Kansas St., El Segundo, California 90245, USA Tel: (310) 252-7105
 TAC Fax: (310) 252-7903

Visit us at www.irf.com for sales contact information.06/2010