

High sound quality, good response and high grade for high end audio devices



### Typical Specifications



Items		Specifications
Total resistance tolerance		±20%
Maximum operating voltage		150V AC
Total rotational angle		300° ±3°
Rotational torque	Dual-unit	28 ± 15mN·m
	Quad-unit	32 ± 15mN·m
Operating life		15,000 cycles
Operating temperature range		-10°C to +70°C

### Product Line

Number of resistor elements	Mounting direction	Shaft type	Length of the shaft L <sub>1</sub> (mm)	Center detent	Total resistance (kΩ)	Resistance taper	Minimum order unit (pcs.)		Products No.	Drawing No.
							Japan	Export		
Dual-unit	Horizontal type	Slotted	25	Without	100	15A	1	1	<b>RK50112A0004</b>	1
Quad-unit			30		50				<b>RK50114A0001</b>	2

### Note

Other varieties are also available. Refer to "Other Specifications" (P.338).

### Dimensions

No.	Photo	Style	Unit:mm
1	<p><b>Single-shaft, dual-unit RK50112</b></p>	<p>Not specified slotting angle</p> <p>Circuit diagram</p> <p>Mounting surface</p> <p>Mounting hole detail view from mounting side</p>	
2	<p><b>Single-shaft, quad.-unit RK50114</b></p>	<p>Not specified slotting angle</p> <p>Circuit diagram</p> <p>Mounting surface</p> <p>Mounting hole detail view from mounting side</p>	

Refer to P.338 for other specifications.  
 Refer to P.338 for attached parts.  
 Refer to P.343 for soldering conditions.

Rotary Potentiometers  
 Slide Potentiometers  
 Metal Shaft  
 Insulated Shaft  
 Knob Operating  
 Through Shaft Type  
 Ring Type

# 50mm Size Metal Shaft High-quality-audio Type / Other Specifications

In addition to the products listed, we can accommodate the follow specifications.

## Total Resistance Variety

Total resistance (kΩ)	10	20	50	100
-----------------------	----	----	----	-----

## Resistance Taper

Resistance taper	15A	3B
------------------	-----	----

## Dimensions of Shaft

Slotted type

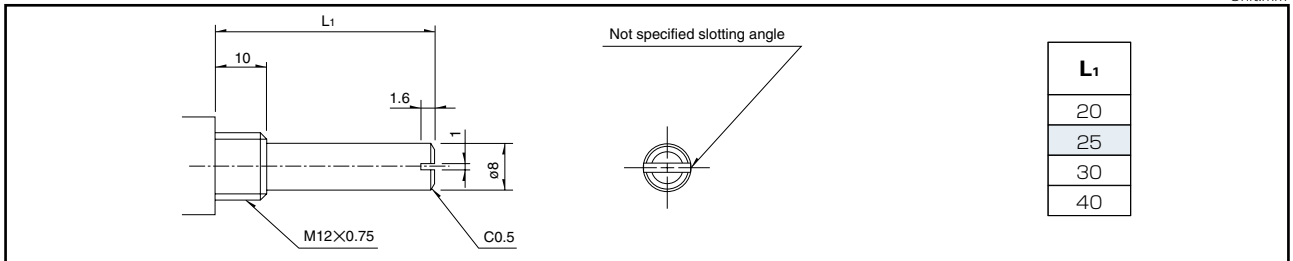









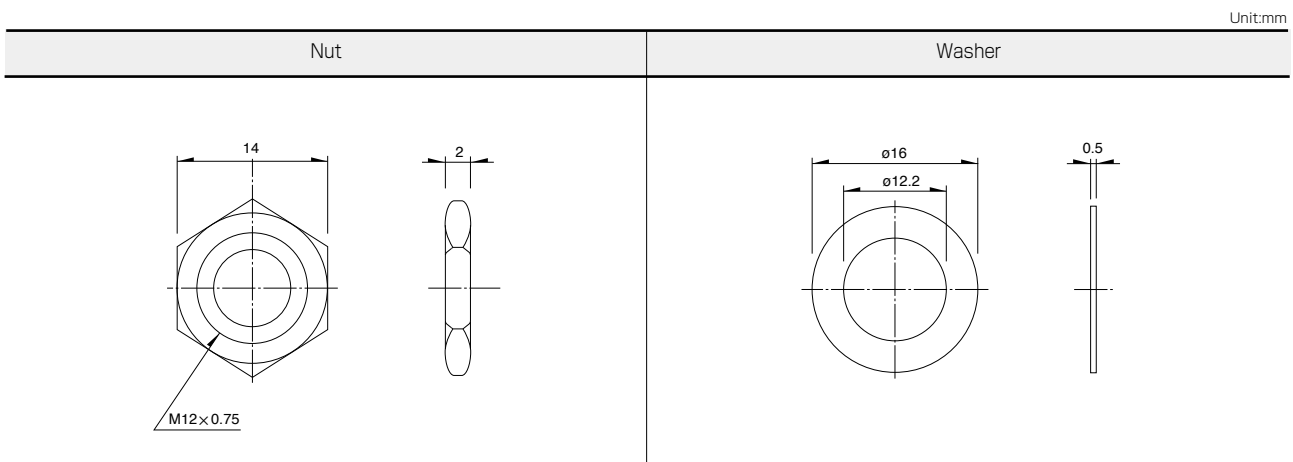

### Note

Marked are specifications recommended by Alps Alpine.

# 50mm Size Metal Shaft High-quality-audio Type / Attached Parts

The following parts are included with the product.



Type	16mm size	20mm size	27mm size	50mm size	Rotary motor-driven	
Series	<b>RK163</b>	<b>RK203</b>	<b>RK271</b>	<b>RK501</b>	<b>RK168</b>	
	Single-shaft					
Number of resistor elements	Single/dual	Single	Single/dual/quad	Dual/quad	Dual/quad/5-ganged/6-ganged	
Photo						
Terminal mounting	Horizontal	Vertical	Horizontal			
Fixing method of bushing	Bushing screw clamp					
Operating temperature range	-10°C to +70°C	-40°C to +85°C	-10°C to +70°C			
Operating life	15,000 cycles	30,000 cycles	15,000 cycles			
Available for automotive use	—	○	—	—	—	
Life cycle (availability)						
Electrical performance	Total resistance (kΩ)	5, 10, 20, 50, 100, 200	10	5, 10, 20, 50, 100, 250	10, 20, 50, 100	
	Resistance taper	15A, 1B, 3B, 15C	B	15A, 3B		
	Rated Power	0.1W 0.05W (15A)	0.05W		0.1W	0.05W
	Residual resistance	R≤10kΩ 20Ω max. 10kΩ<R≤50kΩ 30Ω max. 50kΩ<R<3MΩ Nominal total resistance of 0.1% or less%	—	R≤10kΩ 20Ω max. 10kΩ<R<50kΩ 30Ω max. 50kΩ≤R Nominal total resistance of 0.1% or less%	—	—
	Maximum attenuation (Volume control)	5kΩ≤R<10kΩ 70dB min. 10kΩ≤R<50kΩ 80dB min. 50kΩ≤R<100kΩ 90dB min. 100kΩ≤R 100dB min.	—	5kΩ≤R<10kΩ 70dB min. 10kΩ≤R<50kΩ 80dB min. 50kΩ≤R<100kΩ 90dB min. 100kΩ≤R 100dB min.	120dB min.	5kΩ≤R<10kΩ 70dB min. 10kΩ≤R<50kΩ 80dB min. 50kΩ≤R<100kΩ 90dB min. 100kΩ≤R 100dB min.
	Gang error applicable to Dual-unit parts for audio volume control purposes	-40dB to 0dB 3dB max.	—	-70dB to -60dB 3dB max. -60dB to 0dB 2dB max.	-100dB to 0dB 2dB max.	-60dB to -40dB 5dB max. -40dB to 0dB 3dB max.
	Insulation resistance	100MΩ min. 500V DC	10MΩ min. 250V DC	100MΩ min. 500V DC		100MΩ min. 250V DC
	Voltage proof	500V AC for 1minute	300V AC for 1minute	500V AC for 1minute		300V AC for 1minute
	Center-taps	Without				
Mechanical performance	Detent	Without, Cente	17	Without, Center, 21, 31, 41	Without	
	Stopper strength	0.9 N·m	0.5 N·m	0.9 N·m	1.5 N·m	0.9 N·m
	Push-pull strength	100N max.			150N max.	100N max.
	Vibration	10 to 55 to 10Hz/min., the amplitude is 1.5mm for all the frequencies, in the 3 direction of X, Y and Z for 2 hours respectively				
Shaft style	Serrated type, Flat type, Slotted type	Flat type	Slotted type, Flat type	Slotted type	Flat type	
Terminal style	Insertion, Lead	Insertion				
Attached switch	—	—	—	—	—	
Page	325	330	333	337	339	

Metal Shaft Potentiometers Soldering Conditions	343
Potentiometers Cautions	418
Potentiometers Measurement and Test Methods	420
Potentiometers Resistance Taper	422

**Note**

○ Indicates applicability to some products in the series.

## Reference for Manual Soldering

Series	Tip temperature	Soldering time	No. of solders
<b>RK09L, RK097</b>	350°C max.	3s max.	1 time
<b>RK203</b>	300°C max.	3s max.	1 time
<b>RK119</b>	350±10°C	3 <sup>+1</sup> <sub>0</sub> s	1 time
<b>RK271</b>	350°C max.	5s max.	1 time
<b>RK501</b>	350±10°C	5 <sup>+1</sup> <sub>0</sub> s	1 time
<b>RK163</b>	350°C max.	5s max.	1 time
<b>RK168</b>	<b>Potentiometer terminal</b>	300°C max.	3s max.
	<b>Motor terminal</b>	350°C max.	2s max.

## Reference for Dip Soldering

Series	Preheating		Dip soldering		No. of solders
	Soldering surface temperature	Heating time	Soldering temperature	Soldering time	
<b>RK09L, RK097, RK203</b>	100°C max.	2 min. max.	260±5°C	5±1s	2 time max.
<b>RK501</b>	120±10°C	2 min. max.	260±5°C	5±1s	2 time

## Example of Reflow Soldering Condition

Temperature profile

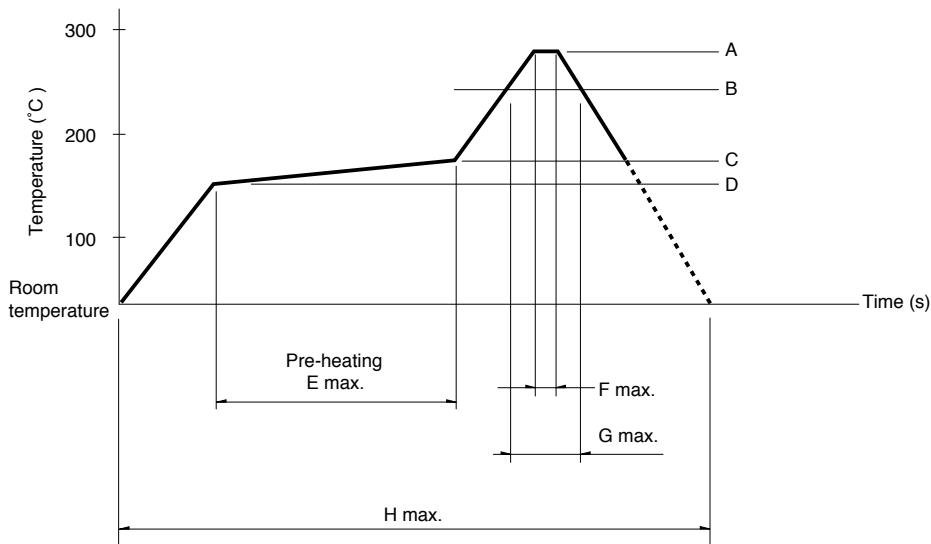

Series	A	B	C	D	E	F	G	H	No. of reflows
<b>RK119</b>	260°C	230°C	180°C	150°C	2 min.	3s	40s	4 min.	2 time max.

### Notes

- When using an infrared reflow oven, solder may sometimes not be applied. Be sure to use a hot air reflow oven or at type that uses infrared rays in combination with hot air.
- The temperatures given above are the maximum temperatures at the terminals of the potentiometer when employing a hot air reflow method. The temperature of the PC board and the surface temperature of the potentiometer may vary greatly depending on the PC board material, its size and thickness. Ensure that the surface temperature of the potentiometer does not rise to 250°C or greater.
- Conditions vary to some extent depending on the type of reflow bath used. Be sure to give due consideration to this prior to use.