

# FP0708

## High frequency, high current power inductors



### Product description

- High current carrying capacity
- Low core loss
- Frequency range up to 2 MHz
- Inductance Range from 72 nH to 200 nH
- Current range from 36 A to 90 A
- 7.0 mm x 8.5 mm footprint surface mount package in a 7.2 mm height
- Ferrite core material
- Halogen free, lead free, RoHS compliant

### Applications

- Multi-phase and Vcore regulators
- Voltage Regulator Modules (VRMs)
  - Server and desktop
  - Central processing unit (CPU)
  - Graphics processing unit (GPU)
  - Application specific integrated circuit (ASIC)
  - High power density
- Data networking and storage systems
- Graphics cards and battery power systems
- Portable electronics
- Point-of-Load modules

### Environmental data

- Storage temperature range (Component): -40 °C to +125 °C
- Operating temperature range: -40 °C to +125 °C (ambient plus self-temperature rise)
- Solder reflow temperature: J-STD-020D compliant



**Product specifications**

Part Number <sup>7</sup>	OCL <sup>1</sup> (nH) ±10%	FLL <sup>2</sup> (nH) minimum	I <sub>rms</sub> <sup>3</sup> (A)	I <sub>sat</sub> 1 <sup>4</sup> (A)	I <sub>sat</sub> 2 <sup>5</sup> (A)	DCR (mΩ) ± 8.6% @ 20°C	K-factor <sup>6</sup>
FP0708R1-R07-R	72	52	44	90	72	0.35	557
FP0708R1-R09-R	90	64	44	75	60	0.35	557
FP0708R1-R10-R	105	75	44	68	54	0.35	557
FP0708R1-R12-R	120	86	44	59	47	0.35	557
FP0708R1-R15-R	150	108	44	47	37	0.35	557
FP0708R1-R19-R	190	135	44	37	29	0.35	557
FP0708R1-R20-R	200	144	44	36	27	0.35	557

- Open Circuit Inductance (OCL) Test Parameters: 100 kHz, 0.1Vrms, 0.0 Adc, +25 °C
- Full Load Inductance (FLL) Test Parameters: 100 kHz, 0.1 Vrms, I<sub>sat</sub>1, +25 °C
- I<sub>rms</sub>: DC current for an approximate temperature rise of 40 °C without core loss. Derating is necessary for AC currents. PCB layout, trace thickness and width, air-flow, and proximity of other heat generating components will affect the temperature rise. It is recommended that the temperature of the part not exceed 125 °C under worst case operating conditions verified in the end application.
- I<sub>sat</sub>1: Peak current for approximately 20% rolloff @ +25 °C
- I<sub>sat</sub>2: Peak current for approximately 20% rolloff @ +125 °C

- K-factor: Used to determine B<sub>pp</sub> for core loss (see graph).  
B<sub>pp</sub> = K \* L \* ΔI \* 10<sup>-3</sup>. B<sub>pp</sub> (Gauss), K: (K-factor from table),  
L: (Inductance in nH), ΔI (Peak to peak ripple current in Amps).
- Part Number Definition: FP0708Rx-Rxx-R  
FP0708= Product code and size  
Rx= Version indicator  
-Rxx= Inductance value in μH, R= decimal point  
-R suffix = RoHS compliant

**Dimensions (mm)**

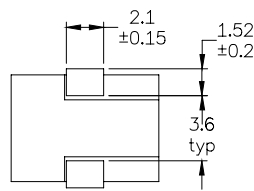
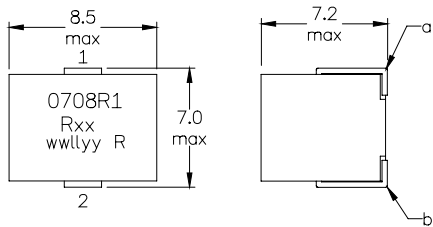

Recommended Pad Layout

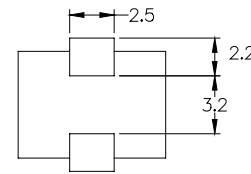

Schematic

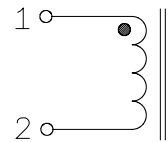

Part marking: 0708Rx (Rx = version indicator), Rxx = Inductance value in uH, R = decimal point, wwllly = date code, R = revision level  
Tolerances are ±0.15 millimeters unless stated otherwise  
PCB tolerances are ±0.1 millimeters unless stated otherwise  
All soldering surface to be coplanar within 0.1016 millimeters  
DCR measured between point "a" and point "b"  
Do not route traces or vias underneath the inductor

**Packaging information (mm)**

Supplied in tape and reel packaging , 640 parts per 13" diameter reel

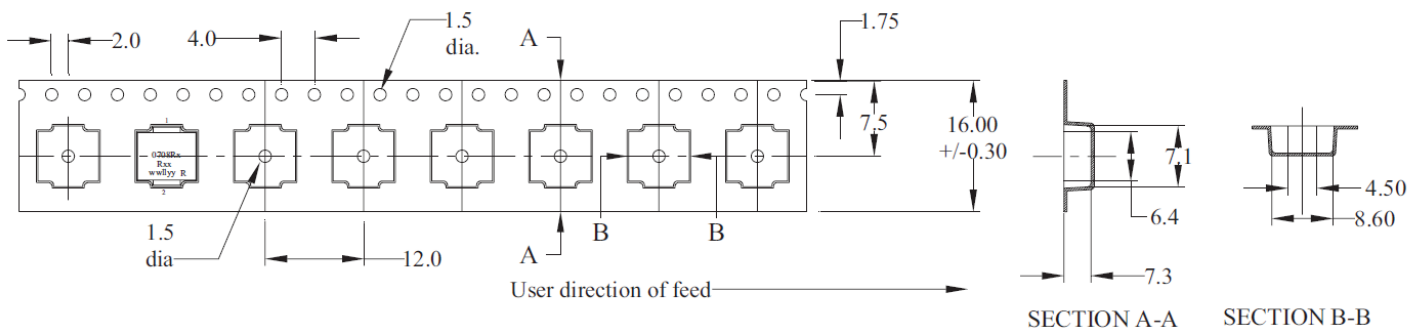

Temperature rise vs. total loss

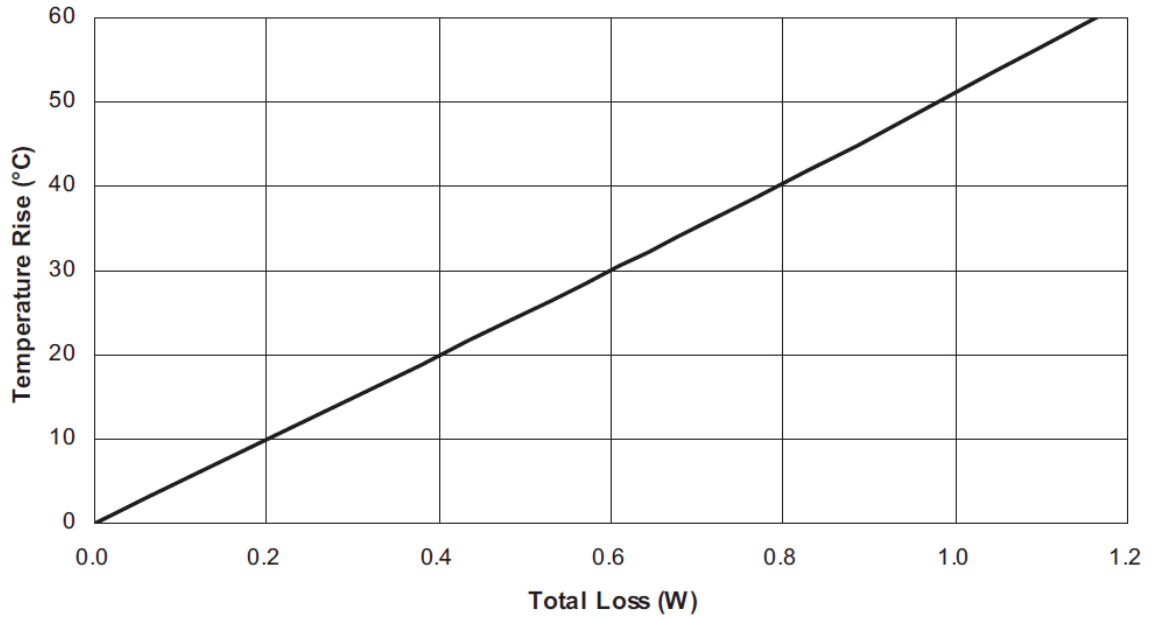

Core loss vs.  $B_{p-p}$

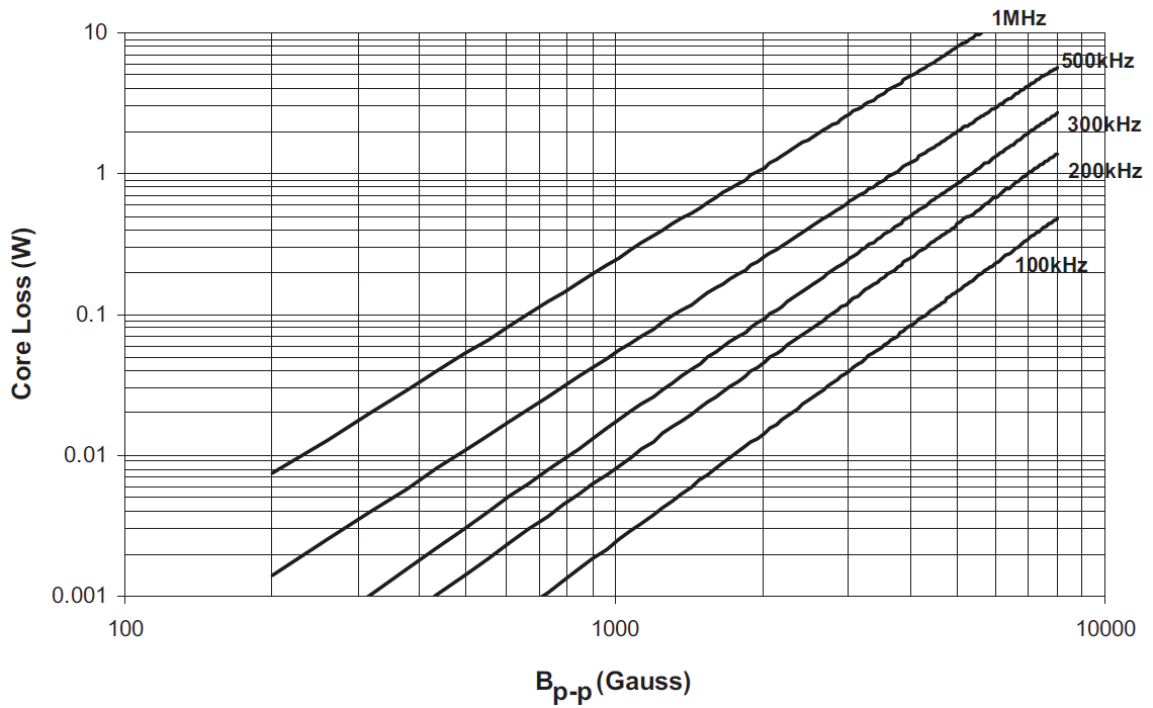

Inductance characteristics

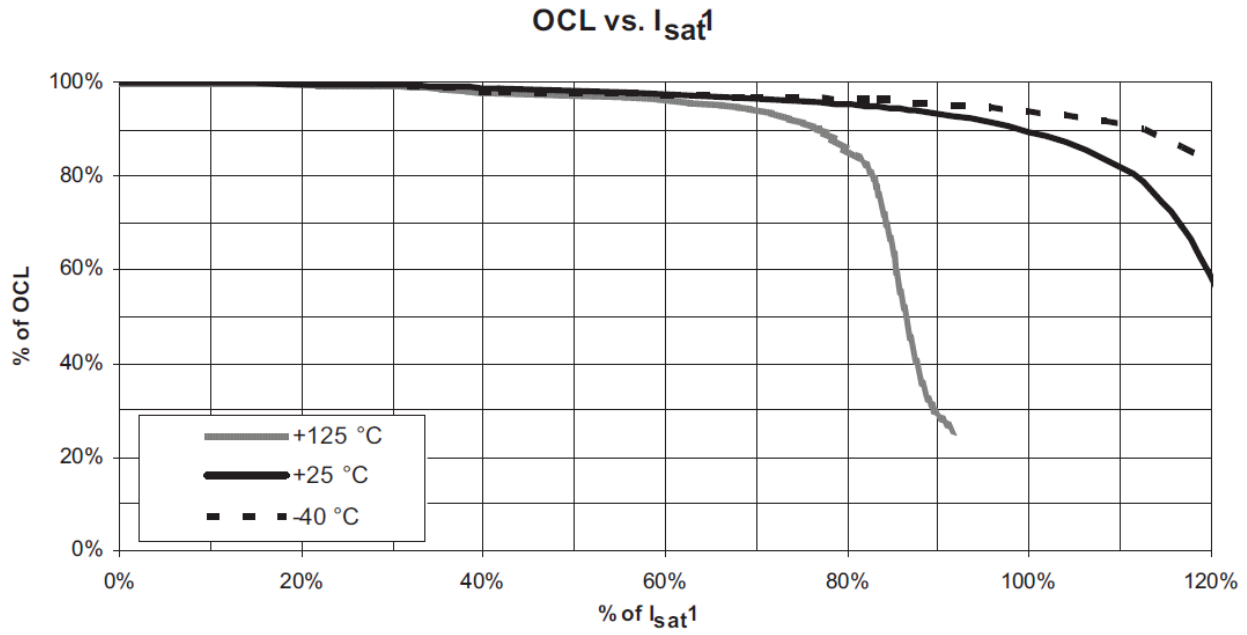

**Solder reflow profile**



**Table 1 - Standard SnPb Solder ( $T_c$ )**

Package Thickness	Volume mm <sup>3</sup> <350	Volume mm <sup>3</sup> ≥350
<2.5mm)	235°C	220°C
≥2.5mm	220°C	220°C

**Table 2 - Lead (Pb) Free Solder ( $T_c$ )**

Package Thickness	Volume mm <sup>3</sup> <350	Volume mm <sup>3</sup> 350 - 2000	Volume mm <sup>3</sup> >2000
<1.6mm	260°C	260°C	260°C
1.6 – 2.5mm	260°C	250°C	245°C
>2.5mm	250°C	245°C	245°C

**Reference JDEC J-STD-020D**

Profile Feature	Standard SnPb Solder	Lead (Pb) Free Solder
Preheat and Soak		
• Temperature min. ( $T_{smin}$ )	100°C	150°C
• Temperature max. ( $T_{smax}$ )	150°C	200°C
• Time ( $T_{smin}$ to $T_{smax}$ ) ( $t_s$ )	60-120 Seconds	60-120 Seconds
Average ramp up rate $T_{smax}$ to $T_p$	3°C/ Second Max.	3°C/ Second Max.
Liquidous temperature ( $T_L$ )	183°C	217°C
Time at liquidous ( $t_L$ )	60-150 Seconds	60-150 Seconds
Peak package body temperature ( $T_p$ )*	Table 1	Table 2
Time ( $t_p$ )** within 5 °C of the specified classification temperature ( $T_c$ )	20 Seconds**	30 Seconds**
Average ramp-down rate ( $T_p$ to $T_{smax}$ )	6°C/ Second Max.	6°C/ Second Max.
Time 25°C to Peak Temperature	6 Minutes Max.	8 Minutes Max.

\* Tolerance for peak profile temperature ( $T_p$ ) is defined as a supplier minimum and a user maximum.  
 \*\* Tolerance for time at peak profile temperature ( $t_p$ ) is defined as a supplier minimum and a user maximum.

Life Support Policy: Eaton does not authorize the use of any of its products for use in life support devices or systems without the express written approval of an officer of the Company. Life support systems are devices which support or sustain life, and whose failure to perform, when properly used in accordance with instructions for use provided in the labeling, can be reasonably expected to result in significant injury to the user.

Eaton reserves the right, without notice, to change design or construction of any products and to discontinue or limit distribution of any products. Eaton also reserves the right to change or update, without notice, any technical information contained in this bulletin.

**Eaton**  
**Electronics Division**  
 1000 Eaton Boulevard  
 Cleveland, OH 44122  
 United States  
 www.eaton.com/elx

© 2016 Eaton  
 All Rights Reserved  
 Printed in USA  
 Publication No. 4334 BU-SB10004  
 January 2016

Eaton is a registered trademark.  
 All other trademarks are property of their respective owners.