

POSISTOR® for Circuit Protection



EU RoHS Compliant

- All the products in this catalog comply with EU RoHS.
- EU RoHS is "the European Directive 2011/65/EU on the Restriction of the Use of Certain Hazardous Substances in Electrical and Electronic Equipment."
- For more details, please refer to our website 'Murata's Approach for EU RoHS' (<http://www.murata.com/info/rohs.html>).

CONTENTS

POSISTOR® and "POSISTOR" in this catalog are the trademarks of Murata Manufacturing Co., Ltd.

Part Numbering	2
Basic Characteristics of POSISTOR®	5
Selection Guide	7
Application Matrix	8
Application Notes	9
1 Overcurrent Protection Chip Type	13
● Chip Type Specifications and Test Methods	20
2 Overcurrent Protection Narrow Current Band 30V Series	22
3 Overcurrent Protection Narrow Current Band 51/60V Series	25
4 Overcurrent Protection Narrow Current Band 140V Series	30
5 Overcurrent Protection 16V Series	33
6 Overcurrent Protection 24/30/32V Series	36
7 Overcurrent Protection 56/80V Series	43
8 Overcurrent Protection 125/140V Series	49
9 Overcurrent Protection 250/265V Series	56
PTGL Series Narrow Current Band Specifications and Test Methods	64
PTGL Series Specifications and Test Methods	66
10 Inrush Current Suppression (Less than 100μF)	67
11 Inrush Current Suppression for High Capacitance (100μF or more)	68
Inrush Current Suppression Specifications and Test Methods	69
12 Overheat Sensing Chip Tight Tolerance Type	70
13 Overheat Sensing Chip Type	71
Overheat Sensing Chip Type (Related Data)	72
Overheat Sensing Chip Tight Tolerance Type (Reference Data)	73
Overheat Sensing Chip Type (Reference Data)	76
Overheat Sensing Chip Tight Tolerance Type Specifications and Test Methods	78
Overheat Sensing Chip Type Specifications and Test Methods	81
14 Overheat Sensing Lead Type	82
● Temperature Sensor Lead Type Specifications and Test Methods	86
⚠Caution/Notice	87
Chip Type PRG/PRF Series Package	97
Lead Type PTGL/PTF Series Package	98



● Part Numbering

PTC Thermistors (POSISTOR®) for Overcurrent Protection Chip Type



① Product ID

Product ID	
PR	PTC Thermistors Chip Type

② Series

Code	Series
G	for Overcurrent Protection

③ Dimensions (L×W)

Code	Dimensions (L×W)	EIA
18	1.60×0.80mm	0603
21	2.00×1.25mm	0805

④ Temperature Characteristics

Code	Temperature Characteristics
BB	Curie Point 100°C
BC	Curie Point 90°C

⑤ Resistance

Expressed by three-digit alphanumerics. The unit is ohm (Ω). The first and second figures are significant digits, and the third figure expresses the number of zeros which follow the two figures. If there is a decimal point, it is expressed by the capital letter "R." In this case, all figures are significant digits.

Ex.

Code	Resistance
470	47Ω
471	470Ω

⑥ Resistance Tolerance

Code	Resistance Tolerance
M	±20%

⑦ Individual Specifications

Ex.

Code	Individual Specifications
B1	Structure, others

⑧ Packaging

Code	Packaging
RA	Embossed Taping (4mm Pitch) (4000 pcs.)
RB	Paper Taping (4mm Pitch) (4000 pcs.)
RK	Embossed Taping (4mm Pitch) (3000 pcs.)

PTC Thermistors (POSISTOR®) for Overheat Sensing Chip Type

(Part Number)

PR	F	18	BB	471	Q	B5	RB
①	②	③	④	⑤	⑥	⑦	⑧

① Product ID

Product ID	
PR	PTC Thermistors Chip Type

② Series

Code	Series
F	for Overheat Sensing

③ Dimensions (L×W)

Code	Dimensions (L×W)	EIA
15	1.00×0.50mm	0402
18	1.60×0.80mm	0603
21	2.00×1.25mm	0805

④ Temperature Characteristics

Code	Temperature Characteristics
AR	Curie Point 120°C
AS	Curie Point 130°C
BA	Curie Point 110°C
BB	Curie Point 100°C
BC	Curie Point 90°C
BD	Curie Point 80°C
BE	Curie Point 70°C
BF	Curie Point 60°C
BG	Curie Point 50°C

⑤ Resistance

Expressed by three figures. The unit is ohm (Ω). The first and second figures are significant digits, and the third figure expresses the number of zeros which follow the two figures.

Ex.

Code	Resistance
471	470Ω

⑥ Resistance Tolerance

Code	Resistance Tolerance	Sensing Temp. Tolerance
Q	Special Tolerance	±5°C
R	Special Tolerance	±3°C

⑦ Individual Specifications

Ex.

Code	Individual Specifications
B5	Structure, others

⑧ Packaging

Code	Packaging
RA	Embossed Taping (4mm Pitch) (4000 pcs.)
RB	Paper Taping (4mm Pitch) (4000 pcs.)
RC	Paper Taping (2mm Pitch) (10000 pcs.)

PTC Thermistors (POSISTOR®)

for Overcurrent Protection / for Inrush Current Suppression / for Overheat Sensing Lead Type

(Part Number)

PT	GL	07	AR	220	M	3P51	A0
①	②	③	④	⑤	⑥	⑦	⑧

① Product ID

Product ID	
PT	PTC Thermistors

② Series

Code	Series
FL	for Overheat Sensing Lead Type
FM	for Overheat Sensing with Lug-terminal
GL	for Current Control (Over Current Protection · Inrush Current Suppression) Lead Type

③ Dimensions

Code	Dimensions
04	Nominal Body Diameter 4mm Series
05	Nominal Body Diameter 5mm Series
07	Nominal Body Diameter 7mm Series
09	Nominal Body Diameter 9mm Series
10	Nominal Body Diameter 10mm Series
12	Nominal Body Diameter 12mm Series
13	Nominal Body Diameter 13mm Series
14	Nominal Body Diameter 14mm Series
16	Nominal Body Diameter 16mm Series
18	Nominal Body Diameter 18mm Series
20	Nominal Body Diameter 20mm Series

④ Temperature Characteristics

Code	Temperature Characteristics
AR	Curie Point 120°C
AS	Curie Point 130°C
BA	Curie Point 110°C
BB	Curie Point 100°C
BC	Curie Point 90°C
BD	Curie Point 80°C
BE	Curie Point 70°C
BF	Curie Point 60°C
BG	Curie Point 50°C
BH	Curie Point 40°C

⑤ Resistance

Expressed by three-digit alphanumerics. The unit is ohm (Ω). The first and second figures are significant digits, and the third figure expresses the number of zeros which follow the two figures. If there is a decimal point, it is expressed by the capital letter "R." In this case, all figures are significant digits.

Ex.

Code	Resistance
R22	0.22 Ω
2R2	2.2 Ω
220	22 Ω

⑥ Resistance Tolerance

Code	Resistance Tolerance
H	±25%
K	±10%
M	±20%
N	±30%
Q	Special Tolerance

⑦ Individual Specifications

Ex.

Code	Individual Specifications
3P51	Lead Type, others

⑧ Packaging

Code	Packaging
A*	Ammo Pack
B*	Bulk

Basic Characteristics of POSISTOR®

■ Basic Characteristics

POSISTOR® has three main characteristics.

1. Resistance - Temperature Characteristics

Although there is a negligible difference between the normal and "Curie Point" temperature, POSISTOR® shows almost constant resistance-temperature characteristics. Yet they have resistance-temperature characteristics that cause resistance to sharply increase when the temperature exceeds the Curie Point. The Curie Point (C.P.) is defined as the temperature at which the resistance value is twice the one at 25°C.

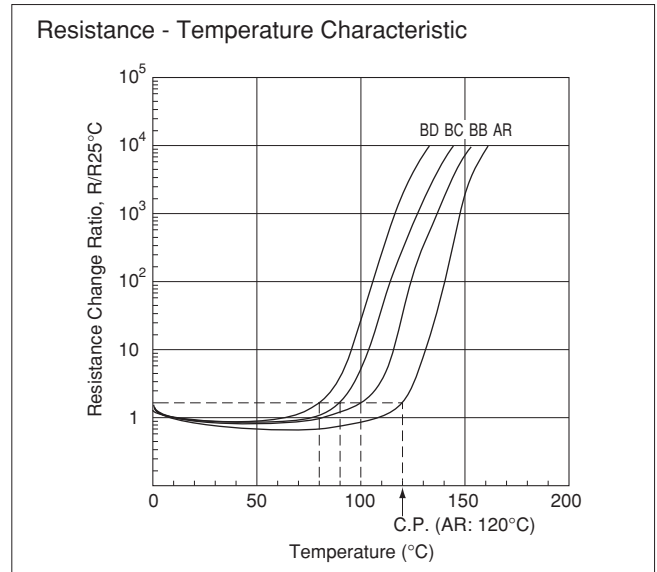

2. Current - Voltage Characteristics (Static Characteristic)

This shows the relation between applied voltage when voltage applied to POSISTOR® causes balancing of inner heating and outer thermal dissipation and stabilized current. This has both a maximum point of current and constant output power.

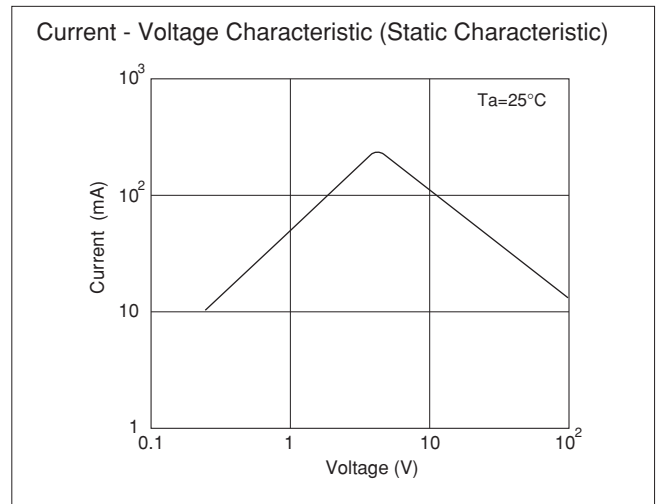

3. Current - Time Characteristics (Dynamic Characteristic)

This shows the relation between current and time before inner heating and outer thermal dissipation arrive at equilibrium state. This features having large initial current and abruptly continuous attenuating portion.

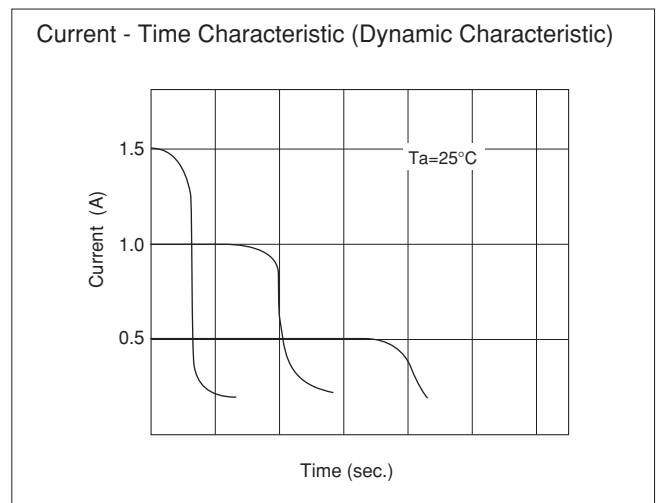

Basic Characteristics of POSISTOR®

Technical Terms

1. Protective Threshold Current

The maximum current value is called the "Protective Threshold Current" for Voltage vs. Current characteristics (static).

When smaller than the protective threshold current flows in POSISTOR®, it reaches its stability (as shown in figure on right) at the intersection (A) of the load curve (a) and voltage-current characteristics of POSISTOR®(c). And POSISTOR® works as a normal fixed resistor.

However, when larger than protective threshold current flows, it stabilizes at the intersection (B) with the load curve (b).

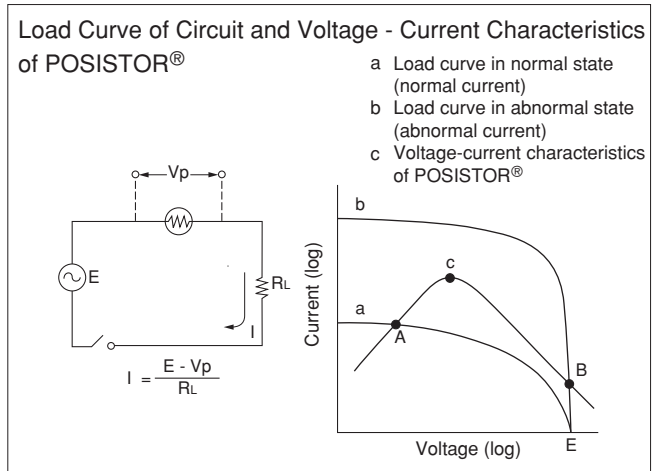

2. Protective Threshold Current Range

Protective threshold current varies depending on the ambient temperature, resistance value, temperature characteristics and shape. (see Figure on right) The maximum value of trip current and the minimum value of the hold current are in the range of ambient temperature -10 to +60°C.

That is, when a current is smaller than the hold current, POSISTOR® works only as a fixed resistor. When larger than the trip current flows, however, POSISTOR® protects the circuit from overload.

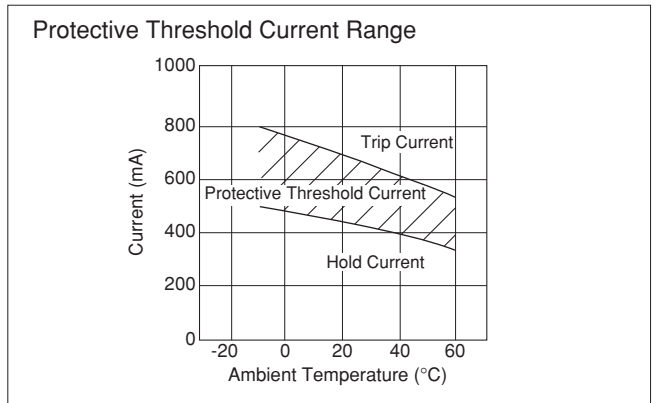

3. Operating Time

A period starting from the voltage input to the moment current itself sharply attenuates is called "Operating Time." Conventionally, operation time (t_o) is determined to be the period until inrush current (I_o) decreases to a level one half the original inrush current ($I_o/2$).

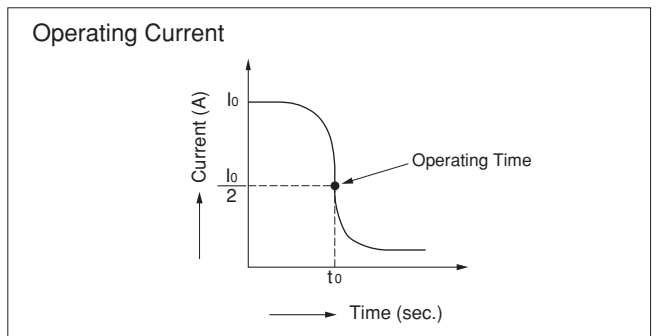

Selection Guide

Please confirm the parameters according to the following questions.
 The best selection is the product that matches three parameters.

● Confirmation Items



● Example



● Selection Standards



Part Number	Max. Voltage (V)	Hold Current at +60°C (mA)	Trip Current at -10°C (mA)	Max. Current (A)	Resistance (at 25°C) (ohm)	Body Diameter (D) (mm)	Thick. (T) (mm)
PTGL18AR4R7M6B72B0	125	360	900	1.7	4.7 ±20%	18.5	5.5
PTGL18AR3R3M6B72B0	125	420	1050	2.0	3.3 ±20%	18.5	5.5
PTGL07AR330M6A51B0	140	100	230	0.5	33 ±20%	7.4	6.0
PTGL09AR220M6C61B0	140	140	330	1.0	22 ±20%	9.6	6
PTGL10AR150M6C61B0	140	170	400	1.0	15 ±20%	11.6	
→ PTGL12AR100M6C01B0	140	220	510	1.0	10 ±20%	13.0	
PTGL13AR6R8M6C01B0	140	290	670	1.0	6.8 ±20%	14.0	
PTGL16AR5R6M6C01B0	140	340	780	2.0	5.6 ±20%	17.0	

PTGL12AR100M6C01B0 is the best selection in this case.

Application Matrix

Application		Series	Overcurrent Protection		Overheat Sensing		
			Chip type PRG	Lead type PTGL	Chip type PRF	Lead type PTFL, PTFM	
AV equipment	Plasma TV		●	●	●	●	
	LCD TV		●	●	●	●	
	Projection TV		●	●	●	●	
	CATV		●	●	●		
	STB		●	●	●		
	Video camera		●		●		
	Digital camera		●		●		
	DVD recorder		●	●	●		
	Audio		●	●	●	●	
	Electric keyboard, Electronic music instrument		●	●	●	●	
	Digital mobile audio		●		●		
	MD/CD player		●		●		
	TV game		●	●	●		
	Portable game		●		●		
Information equipment	Laptop		●		●		
	Desktop computer		●		●		
	Server		●	●	●	●	
	Printer		●	●	●	●	
	Scanner		●		●		
	LCD display		●	●	●	●	
	USB access device		●				
	HDD				●		
	CD/DVD-ROM/RAM				●		
	Copy machine		●	●	●	●	
	Electronic dictionary/databook		●		●		
	Electronic blackboard		●	●	●	●	
	Communications equipment	Electronic automatic exchange		●	●		
Transmission equipment			●	●			
PBX			●	●			
Cordless telephone				●			
Fax machine			●	●	●	●	
Modem			●	●	●		
Cellular phone			●		●		
Headset					●		
Cellular phone base station			●	●	●	●	
Intercom			●	●			
Car electronics		Engine control ECU		●		●	
	Drive control ECU		●		●		
	Air bag		●		●		
	Anticollision radar				●		
	ABS/ESC		●		●		
	Instrument/display panel, Meter		●		●		
	Rechargeable battery for EV/HEV		●	●	●		
	Car air conditioner				●		
	HID/LED headlight, AFS		●	●	●		
	LED tail light		●	●	●		
	LED interior light		●		●		
	Retractable electric mirror		●	●			
	Door lock, trunk opener			●			
	Power seat			●			
	Shock absorber			●			
	VICS, ETC				●		
	Burglar alarm		●	●			
	Car navigation		●	●	●		
	Car audio		●	●	●	●	
	Home electronics Household equipment	Refrigerator		●	●	●	
Microwave, Oven			●	●	●		
Electric rice-cooker				●	●		
IH cooking device				●	●		
Air conditioner			●	●	●		
Fan heater					●	●	
Cleaner				●	●		
Clothes washer, cloth dryer				●			
Ventilator				●	●		
Hot-water pot				●	●	●	
Illumination device			●	●	●	●	
Massage chair, healthcare equipment			●	●	●	●	
Hot water spray toilet seat					●	●	
Electric power tool			●	●	●	●	
Power supply		Switching supply		●	●	●	●
		Inverter power		●	●	●	●
	AC adapter, battery charger		●	●	●		

Application Notes

■ Inrush Current Limit for Power Supply

POSISTOR® Lead type: PTGL series

1. Applications

POSISTOR® is an integrated solution to work as both current limit resistor and overcurrent fuse. It works as a stable resistor in normal operation and protects itself against overcurrent situations.

- (1) High wattage power supply (flat display panels etc.)
- (2) Power supply for fluorescent lights
- (3) Other switching power supplies

Replacement idea for a resistor and fuse solution



2. Benefits

- (1) Protection against overcurrent situations
- (2) Automatic reset from protective trip mode
- (3) Space-saving
- (4) Various characteristics to meet a suitable resistance value

3. Recommended part numbers

Choose an appropriate part number based on the resistance value required to the inrush current limit.
 Review the maximum voltage.

Application	Part Number	Max. Voltage (V)	Resistance (at 25 °C) (ohm)	Body Diameter (mm)	Thickness (mm)	Lead Space (mm)	Lead Diameter (mm)	More Details
For high wattage power supply	PTGL13AR100H8B72B0	265	10 ±25%	14.0	6.0	7.5	0.60	page 57
	PTGL12AR150H8B72B0		15 ±25%	12.5	6.0	7.5	0.60	page 57
	PTGL14AR180M9C01B0		18 ±20%	15.7	6.5	10.0	0.65	page 57
	PTGL09AR250H8B52B0		25 ±25%	10.0	6.0	5.0	0.60	page 57
	PTGL09AR390M9C61B0		39 ±20%	10.0	6.5	6.5	0.65	page 57
For power supply of electronic fluorescent ballasts	PTGL07AR560M9B51A0	280	56 ±20%	8.2	6.5	5.0	0.60	-
	PTGL07AR820M9B51A0		82 ±20%	8.2	6.5	5.0	0.60	-
	PTGL07AS121M0N51A0	280	120 ±20%	7.8	6.0	5.0	0.50	page 67
	PTGL07AS181M0N51A0		180 ±20%	7.8	6.0	5.0	0.50	page 67

Please ask for details.

Application Notes

■ Overcurrent Protection for Communication Facility

POSISTOR® Lead type: PTGL series

1. Applications

POSISTOR® is an efficient device to protect a telephone line interface (SLIC: Subscriber-Loop-Interface-Circuit) against AC line contact.

- (1) Landline telephones or FAX machines
- (2) Telephone interface of STB, VoIP equipment
- (3) Any other equipment of communication facility having a phone line interface

Replacement idea for a current fuse.



2. Benefits

- (1) Automatic reset from protective trip up to 265V AC line contact
- (2) Compatible with the 600V over voltage test by UL60950
- (3) High resistance to the lightning surge (*A surge absorber is still required to protect SLIC)

3. Recommended part numbers

Choose an appropriate part number based on the hold current and on the resistance value required to the operation current of SLIC.

Part Number	Max. Voltage (V)	Max. Current (A)	Hold Current (at +60 °C) (mA)	Trip Current (at -10 °C) (mA)	Resistance (at +25 °C) (ohm)	Body Diameter (mm)	Thickness (mm)	Lead Space (mm)	Lead Diameter (mm)	More Details
PTGL07BB220N0B52A0	250	0.5	90	300	22 ±30%	8.0	6.0	5.0	0.6	page 56
PTGL09AR390N0B52A0	250	0.6	100	280	39 ±30%	10.0	6.0	5.0	0.6	page 56
PTGL09AR250H8B52B0	265	1.0	118	330	25 ±25%	10.0	6.0	5.0	0.6	page 57

Please ask for details.

Application Notes

■ Current Limiter for LED

Chip POSISTOR®: PRG series

1. Applications

POSISTOR® is an effective current limit solution based on LED's allowable current and temperature characteristics.

- (1) LED lighting instruments
- (2) LED backlight of flat displays

See below figures.

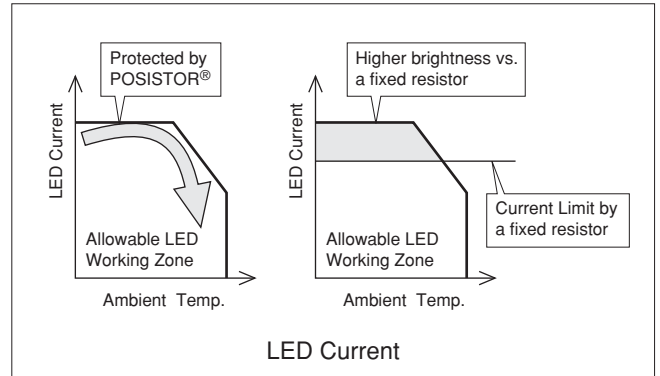

2. Benefits

- (1) Higher LED brightness versus a fixed resistor. LED can work in the smaller series resistance with POSISTOR® at normal operation temperature. The number of LEDs is possibly reduced.
- (2) LED lifetime may be extended due to the current limiting function of the POSISTOR® in cases of overheat or overcurrent situation.
- (3) Small 0805 package allows the POSISTOR® to be placed close to the LED. It offers accurate detection of ambient temperature near LED and increases flexibility of packaging.

3. Recommended part numbers

Choose an appropriate part number having max. voltage and resistance value. Review the protective threshold current range based on the operating current and temperature of the LED.

Part Number	Max. Voltage (V)	Max. Current (A)	Hold Current (at +60 °C) (mA)	Trip Current (at -10 °C) (mA)	Resistance (at +25 °C) (ohm)	Curie Point (°C) *	More Details
PRG21BC0R6MM1RA	6	10	285	1100	0.6 ±20%	90	page 14
PRG21BC0R2MM1RA	6	10	500	2000	0.2 ±20%	90	page 14
PRG21BC1R0MM1RA	12	10	220	850	1.0 ±20%	90	page 14
PRG21BC2R2MM1RA	16	6.5	150	600	2.2 ±20%	90	page 14
PRG21BC3R3MM1RA	20	6.0	120	480	3.3 ±20%	90	page 14
PRG21BC6R8MM1RA	30	3.5	80	320	6.8 ±20%	90	page 14
PRG21BC4R7MM1RA	30	5.0	100	400	4.7 ±20%	90	page 14

*Curie Point means the temperature at which the resistance value reaches twice the resistance at 25°C.
 Please ask for details.

Application Notes

Overheat/Overcurrent Protection for High Brightness LED

Leaded POSISTOR®: PTGL series & Chip POSISTOR®: PRG series

1. Applications

POSISTOR® is an effective solution to protect the LED against overheat and overcurrent situation.

(1) LED lighting instruments (Appliances, Automotive etc.)



2. Benefits

- (1) Posistor installed in series with LED provides both overheat and overcurrent protection
- (2) No additional driver IC or software required

- (3) Automatic reset from protective trip mode
- (4) 0603 and 0805 SMD type available (smaller than 1/2W or 1W chip resistor)

3. Recommended part numbers

Choose an appropriate part number having max. voltage and resistance value. Review the protective threshold

current range based on the operating current and temperature of the LED.

Type	Part Number	Max. Voltage (V)	Max. Current (A)	Hold Current (at +60 °C) (mA)	Trip Current (at -10 °C) (mA)	Resistance (at +25 °C) (ohm)	Curie Point (°C) *	More Details
SMD type	PRG21BC0R6MM1RA	6	10	285	1100	0.6 ±20%	90	page 14
	PRG21BC0R2MM1RA	6	10	500	2000	0.2 ±20%	90	page 14
	PRG21BC1R0MM1RA	12	10	220	850	1.0 ±20%	90	page 14
	PRG21BC2R2MM1RA	16	6.5	150	600	2.2 ±20%	90	page 14
	PRG21BC3R3MM1RA	20	6.0	120	480	3.3 ±20%	90	page 14
	PRG21BC6R8MM1RA	30	3.5	80	320	6.8 ±20%	90	page 14
	PRG21BC4R7MM1RA	30	5.0	100	400	4.7 ±20%	90	page 14
Lead type	PTGL04AS100K2N51B0	30	1.5	122	240	10 ±10%	130	page 22
	PTGL04AS100K2B51B0	30	2.0	167	330	10 ±10%	130	page 22
	PTGL05AS3R9K2B51B0	30	3.5	269	530	3.9 ±10%	130	page 22
	PTGL07AS2R7K2B51B0	30	4.5	336	663	2.7 ±10%	130	page 22
	PTGL07AS1R8K2B51B0	30	5.0	420	829	1.8 ±10%	130	page 22
	PTGL09AS1R2K2B51B0	30	6.0	556	1097	1.2 ±10%	130	page 22
	PTGL12AS0R8K2B51B0	30	7.0	685	1352	0.8 ±10%	130	page 22
	PTGL04AS100K3B51B0	51	1.0	168	332	10 ±10%	130	page 25
	PTGL05AS6R8K3B51B0	51	1.5	197	388	6.8 ±10%	130	page 25
	PTGL07AS3R3K3B51B0	51	3.0	307	606	3.3 ±10%	130	page 25
	PTGL09AS2R2K3B51B0	51	4.0	412	814	2.2 ±10%	130	page 25
	PTGL12AS1R2K3B51B0	51	5.0	592	1168	1.2 ±10%	130	page 25
	PTGL07AR220M3P51B0	56	1.0	90	240	22 ±20%	120	page 43
	PTGL07AR8R2M3P51B0	56	1.0	130	350	8.2 ±20%	120	page 43
	PTGL09AR150M3B51B0	56	1.2	150	400	15 ±20%	120	page 43
	PTGL10AR3R9M3P51B0	56	2.0	210	550	3.9 ±20%	120	page 43
	PTGL09AR4R7M3B51B0	56	2.0	270	700	4.7 ±20%	120	page 43
PTGL10AR3R9M3B51B0	56	2.0	300	800	3.9 ±20%	120	page 43	
PTGL14AR3R3M3B71B0	56	2.5	380	980	3.3 ±20%	120	page 43	

* Curie Point means the temperature at which the resistance value reaches twice the resistance at 25°C.

Please ask for details.

POSISTOR[®] for Circuit Protection



Overcurrent Protection Chip Type

Overcurrent Protection device with resettable function suitable for current limiting resistor.

This product is a chip type PTC thermistor for overcurrent protection that is suitable for the following.

- Countermeasure for short circuit testing
- Current limiting resistor

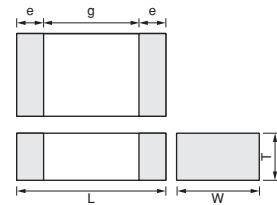

■ Features

1. Rapid operation to protect the circuit in an overcurrent condition abnormality such as a short circuit.
 By removing the overcurrent condition, these products automatically return to the initial condition and can be used repeatedly.
2. Suitable for countermeasure to short circuit test in safety standard.
3. Stable resistance after operation due to ceramic PTC.
4. Similar size (0603 size) is possible due to the large capacity for electric power.
5. Possible to use these products as current limiting resistors with overcurrent protection functions
6. The SMD type's small size and light weight are helpful in miniaturizing the circuit.

Part Number	Dimensions (mm)				
	L	W	T	e	g
PRG18_RB	1.6±0.15	0.8±0.15	0.8±0.15	0.1 to 0.6	-
PRG21_RA	2.0±0.2	1.25±0.2	0.9±0.2	0.2 min.	0.5 min.
PRG21_RK	2.0±0.2	1.25±0.2	1.25±0.2	0.2 min.	0.5 min.

Chip Type 0603(1608) Size

Part Number	Max. Voltage (V)	Hold Current (at +60°C) (mA)	Hold Current (at +25°C) (mA)	Trip Current (at +25°C) (mA)	Trip Current (at -10°C) (mA)	Max. Current (mA)	Resistance (at +25°C) (ohm)
PRG18BB471MB1RB	24	7	10	21	25	60	470 ±20%
PRG18BB221MB1RB	24	10	14	29	35	130	220 ±20%
PRG18BB101MB1RB	24	15	21	45	55	300	100 ±20%
PRG18BB470MB1RB	24	20	29	61	75	630	47 ±20%
PRG18BB330MB1RB	24	25	36	71	85	900	33 ±20%
PRG18BC6R8MM1RB	20	80	120	260	320	3500	6.8 ±20%
PRG18BC4R7MM1RB	20	100	155	330	400	5000	4.7 ±20%
PRG18BC3R3MM1RB	16	120	180	400	480	6000	3.3 ±20%
PRG18BC2R2MM1RB	12	150	220	500	600	6500	2.2 ±20%
PRG18BC1R0MM1RB	6	220	330	740	850	7500	1.0 ±20%

Maximum Current shows typical capacities of the transformer which can be used.
 This series is applied to reflow soldering.
 This series is recognized by UL.

Chip Type 0805(2012) Size

Part Number	Max. Voltage (V)	Hold Current (at +60°C) (mA)	Hold Current (at +25°C) (mA)	Trip Current (at +25°C) (mA)	Trip Current (at -10°C) (mA)	Max. Current (mA)	Resistance (at +25°C) (ohm)
PRG21BB220MB1RK	20	30	44	91	110	1100	22 ±20%
PRG21BB150MB1RK	20	40	59	116	140	1600	15 ±20%
PRG21BC6R8MM1RA	30	80	120	260	320	5500	6.8 ±20%
PRG21BC4R7MM1RA	30	100	155	330	400	8000	4.7 ±20%
PRG21BC3R3MM1RA	20	120	180	400	480	6000	3.3 ±20%
PRG21BC2R2MM1RA	16	150	220	500	600	6500	2.2 ±20%
PRG21BC1R0MM1RA	12	220	330	740	850	10000	1.0 ±20%
PRG21BC0R6MM1RA	6	285	420	920	1100	10000	0.6 ±20%
PRG21BC0R2MM1RA	6	500	750	1620	2000	10000	0.2 ±20%

Maximum Current shows typical capacities of the transformer which can be used.

This series is applied to reflow soldering.

This series is recognized by UL.

Standard Land Pattern Dimensions

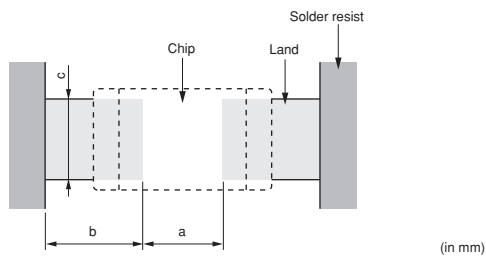

Part Number	Soldering Methods	Dimensions (mm)			
		Chip (L×W)	a	b	c
PRG18	Reflow Soldering	1.6×0.8	0.6-0.8	0.6-0.7	0.6-0.8
PRG21	Reflow Soldering	2.0×1.25	1.0-1.2	0.5-0.7	1.0-1.2

Protective Threshold Current Range

PRG18BB471MB1RB



PRG18BB221MB1RB

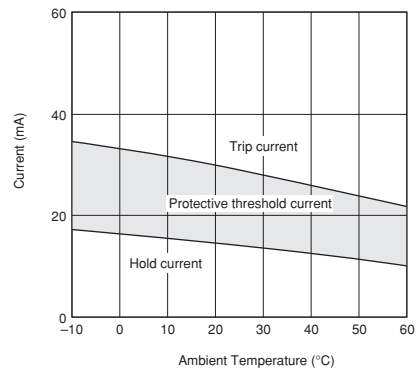

Continued on the following page.

Continued from the preceding page.

Protective Threshold Current Range

PRG18BB101MB1RB

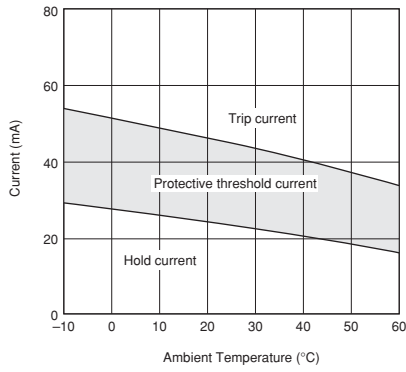

PRG18BB470MB1RB



PRG18BB330MB1RB



PRG18/21BC6R8M Type



PRG18/21BC4R7M Type



PRG18/21BC3R3M Type



PRG18/21BC2R2M Type



PRG18/21BC1R0M Type



Continued on the following page. ↗

Continued from the preceding page.

Protective Threshold Current Range

PRG21BB220MB1RK



PRG21BB150MB1RK



PRG21BC0R6MM1RA

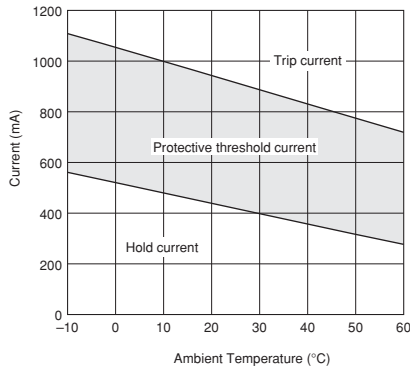

PRG21BC0R2MM1RA



Operating Time (Typical Curve)

PRG18BB471MB1RB

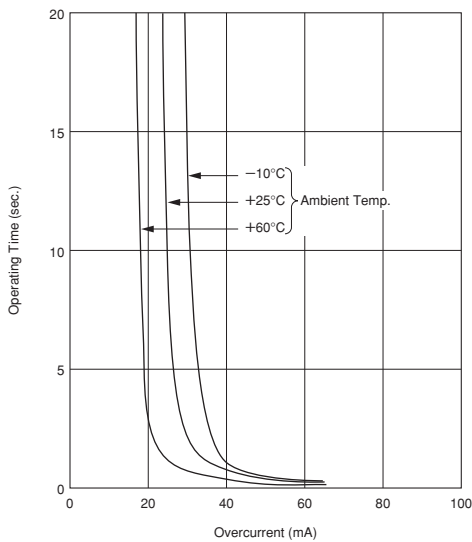

PRG18BB221MB1RB

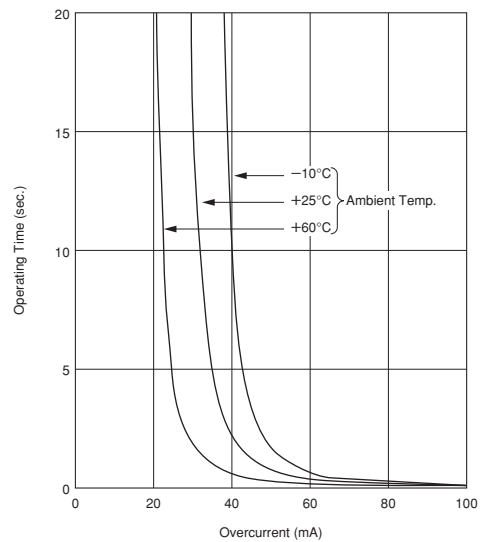

Continued on the following page. ↗

Continued from the preceding page.

Operating Time (Typical Curve)

PRG18BB101MB1RB



PRG18BB470MB1RB



PRG18BB330MB1RB



PRG18BC6R8MM1RB



PRG18BC4R7MM1RB



PRG18BC3R3MM1RB



Continued on the following page. ↗

Continued from the preceding page.

Operating Time (Typical Curve)

PRG18BC2R2MM1RB

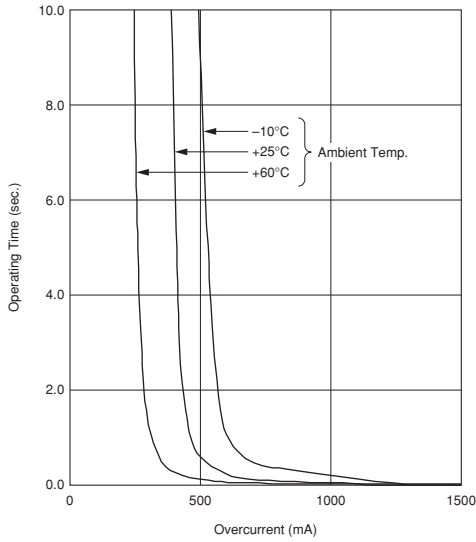

PRG18BC1R0MM1RB

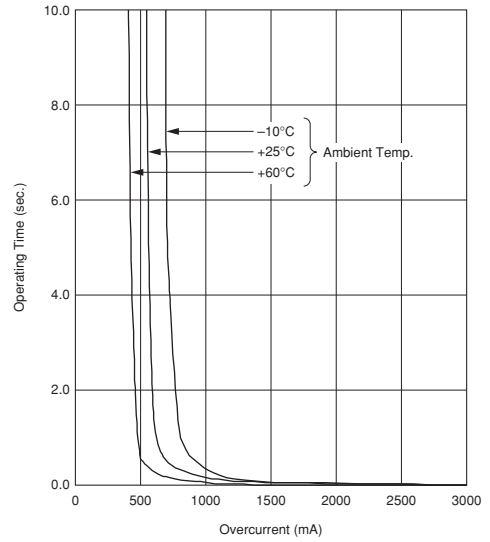

PRG21BB220MB1RK



PRG21BB150MB1RK



PRG21BC6R8MM1RA

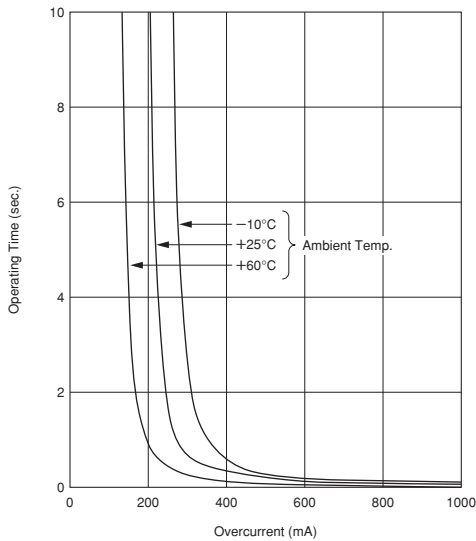

PRG21BC4R7MM1RA



Continued on the following page. ↗

Continued from the preceding page.

Operating Time (Typical Curve)

PRG21BC3R3MM1RA



PRG21BC2R2MM1RA



PRG21BC1R0MM1RA

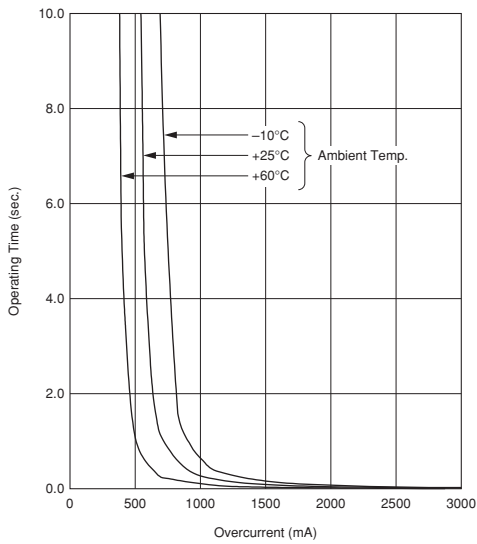

PRG21BC0R6MM1RA

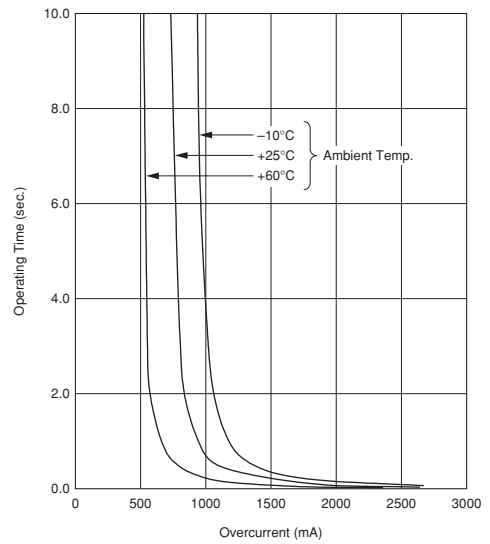

PRG21BC0R2MM1RA



Chip Type Specifications and Test Methods

■ PRG18/21BB Series

No.	Item	Rating Value	Method of Examination															
1	Operating Temp.	-10 to 60°C	Temperature range with maximum voltage applied to PTC.															
2	Resistance Value (at 25°C)	The resistance value should be within the specified tolerance.	After applying maximum operating voltage for 3 mins. and leaving for 2 hrs. in 25°C, measured by applying voltage of less than 1.5Vdc (by a direct current of less than 10mA).															
3	Withstanding Voltage	Without damage	We apply 120% of the maximum operating voltage to PTC by raising gradually for 180±5 secs. at 25°C. (A protective resistor is to be connected in series, and the inrush current through PTC must be limited below maximum rated value.)															
4	Adhesive Strength	There is no sign of exfoliation on electrode.	EIAJ ET-7403 term 9 Soldered PTC to PCB and add a force of 5.0N in the direction as shown below. 															
5	Vibration	Normal appearance Resistance change: not to exceed ±20% (*)	JIS C 5102 term 8.2 Soldered PTC to PCB Vibration: A 10-55-10Hz (1 min.) Width: 1.5mm Vibrate for 2 hrs. in each of 3 mutually perpendicular planes for a total of 6 hrs.															
6	Solderability	Min. 75% electrode is covered with new solder. Resistance change: not to exceed ±20% (*)	JIS C 5102 term 8.4 Solder: Sn 63%/Pb 37% (or 60/40%) Solder temp: 230±5°C Soaking time: 3±0.5 secs. Soaking position: Until a whole electrode is soaked															
7	Soldering Heat Resistance	Normal appearance Resistance change: not to exceed ±20% (*)	Solder: Sn 63%/Pb 37% (or 60/40%) Flux: Solder paste containing less than 0.2wt% of chlorine. Preheating: 150±5°C 3 mins. Peak temp.: 260±5°C 10±5 secs. (reflow) PCB: Glass Epoxy PCB (JIS C 6484)															
8	Temperature Cycling	Normal appearance Resistance change: not to exceed ±20% (*)	JIS C 5102 term 9.3 Times: 5 cycles <table border="1" data-bbox="938 1332 1321 1460"> <thead> <tr> <th>Step</th> <th>Temp. (°C)</th> <th>Time (min.)</th> </tr> </thead> <tbody> <tr> <td>1</td> <td>-20 +0, -3</td> <td>30</td> </tr> <tr> <td>2</td> <td>Room temp.</td> <td>10-15</td> </tr> <tr> <td>3</td> <td>+85 +3, -0</td> <td>30</td> </tr> <tr> <td>4</td> <td>Room temp.</td> <td>10-15</td> </tr> </tbody> </table>	Step	Temp. (°C)	Time (min.)	1	-20 +0, -3	30	2	Room temp.	10-15	3	+85 +3, -0	30	4	Room temp.	10-15
Step	Temp. (°C)	Time (min.)																
1	-20 +0, -3	30																
2	Room temp.	10-15																
3	+85 +3, -0	30																
4	Room temp.	10-15																
9	Damp Heat	Normal appearance Resistance change: not to exceed ±20% (*)	JIS C 5102 term 9.5 40±2°C, 90-95%RH leave for 500±4 hrs.															
10	High Temperature Load	Normal appearance Resistance change: not to exceed ±20% (*)	JIS C 5102 term 9.10 60±3°C (in air), PTC is applied maximum operating voltage for 1.5 hrs. on and 0.5 hrs. off. This cycle is repeated for 1000±10 hrs.															

(*) Measure resistance after the test by applying voltage of less than 1.5Vdc by a direct current of less than 10mA after product is left at 25±2°C for 2 hours.

Above mentioned soldering in "4. Adhesive Strength" and "5. Vibration" is done under the following conditions at our site.

- Glass-Epoxy PC board
- Standard land dimension
- Standard solder paste
- Standard solder profile

Above conditions are mentioned in Notice.

Chip Type Specifications and Test Methods

■ PRG18/21BC Series

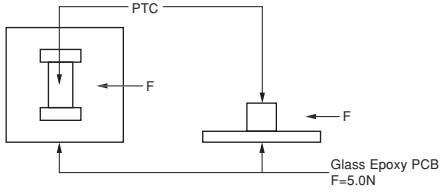
No.	Item	Rating Value	Method of Examination														
1	Operating Temp.	-10 to 60°C	Temperature range with maximum voltage applied to PTC.														
2	Resistance Value (at 25°C)	The resistance value should be within the specified tolerance.	After leaving for 24 hrs. or more in 25°C, it measures by 4 wire measuring methods using the direct-current terminal current of 10mA or less (0.1 or less Vdcs).														
3	Withstanding Voltage	Without damage	We apply 120% of the maximum operating voltage to PTC by raising gradually for 180±5 secs. at 25°C. (A protective resistor is to be connected in series, and the inrush current through PTC must be limited below maximum rated value.)														
4	Adhesive Strength	There is no sign of exfoliation on electrode.	EIAJ ET-7403 term 9 Soldered PTC to PCB and add a force of 5.0N in the direction as shown below. 														
5	Vibration	Normal appearance Resistance change: not to exceed ±20% (*)	JIS C 5102 term 8.2 Soldered PTC to PCB Vibration: A 10-55-10Hz (1 min.) Width: 1.5mm Vibrate for 2 hrs. in each of 3 mutually perpendicular planes for a total of 6 hrs.														
6	Solderability	Min. 75% electrode is covered with new solder. Resistance change: not to exceed ±20% (*)	JIS C 5102 term 8.4 Solder: Sn-3Ag-0.5Cu Solder temp: 245±5°C Soaking time: 3±0.5 secs. Soaking position: Until a whole electrode is soaked.														
7	Soldering Heat Resistance	Normal appearance Resistance change: not to exceed ±20% (*)	Solder: Sn-3Ag-0.5Cu Flux: Solder paste containing less than 0.2wt% of chlorine. Preheating: 150±5°C 3 mins. Peak temp.: 260±5°C 10±5 secs. (reflow) PCB: Glass Epoxy PCB (JIS C 6484)														
8	Dry Heat	Normal appearance Resistance change: not to exceed ±20% (*)	60±3°C leave for 1000±12 hrs.														
9	Cold		-10±3°C leave for 1000±12 hrs.														
10	Damp Heat		60±2°C, 90-95%RH leave for 500±4 hrs.														
11	Temperature Cycling		JIS C 5102 term 9.3 Times: 5 cycles <table border="1" style="margin-left: auto; margin-right: auto;"> <thead> <tr> <th>Step</th> <th>Temp. (°C)</th> <th>Time (min.)</th> </tr> </thead> <tbody> <tr> <td>1</td> <td>-20 +0, -3</td> <td>30</td> </tr> <tr> <td>2</td> <td>Room temp.</td> <td>10-15</td> </tr> <tr> <td>3</td> <td>+85 +3, -0</td> <td>30</td> </tr> <tr> <td>4</td> <td>Room temp.</td> <td>10-15</td> </tr> </tbody> </table>	Step	Temp. (°C)	Time (min.)	1	-20 +0, -3	30	2	Room temp.	10-15	3	+85 +3, -0	30	4	Room temp.
Step	Temp. (°C)	Time (min.)															
1	-20 +0, -3	30															
2	Room temp.	10-15															
3	+85 +3, -0	30															
4	Room temp.	10-15															
12	High Temperature Load		60±3°C (in air), PTC is applied maximum operating voltage for 1.5 hrs. on and 0.5 hrs. off. This cycle is repeated for 500±10 hrs.														

(*) The resistance measurement after the test.

After leaving for 24 hours or more in 25±2°C, it measures by 4 wire measuring methods using the direct-current terminal current of 10mA or less (0.1 or less Vdcs).

Above mentioned soldering in "4. Adhesive Strength" and "5. Vibration" is done under the following conditions at our site.

- Glass-Epoxy PC board
- Standard land dimension
- Standard solder paste
- Standard solder profile

Above conditions are mentioned in Notice.

POSISTOR[®] for Circuit Protection



Overcurrent Protection Narrow Current Band 30V Series

2

This product is a leaded type PTC thermistor for overcurrent protection which is suitable for a current limiting resistor.

■ Features

1. Small fluctuation in the circuit due to resistance tolerance +/-10%
2. Narrow current range (less than twice) between operating and non-operating current at -10 to 60 degrees C.
3. Quick operating time due to small size compared with conventional products.
4. Best suited to meet the requirements for power supplies and motor protection. Error-free operations are assured by rush current.
5. Circuit is protected until current is turned off.
6. Restores the original low resistance value automatically once the overload is removed.
7. Non-contact design leads to long life and no noise.
 Durable and strong against mechanical vibration and shock because it is a solid element.

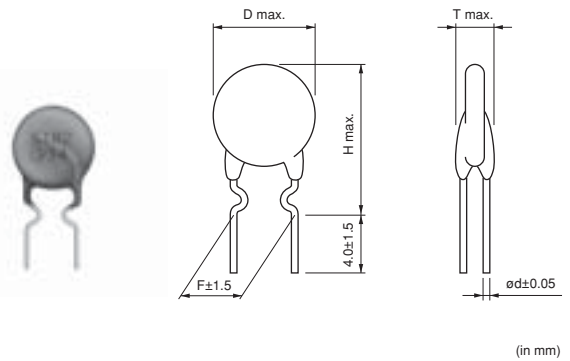

Part Number	Max. Voltage (V)	Hold Current (at +60°C) (mA)	Hold Current (at +25°C) (mA)	Trip Current (at +25°C) (mA)	Trip Current (at -10°C) (mA)	Max. Current (A)	Resistance (at +25°C) (ohm)	Body Diameter (D) (mm)	Thickness (T) (mm)	Height (H) (mm)	Lead Space (F) (mm)	Lead Diameter (phi d) (mm)
PTGL04AS100K2N51B0	30	122	154	205	240	1.5	10 ±10%	4.5	3.5	9.5	5.0	0.5
PTGL04AS100K2B51B0	30	167	212	282	330	2.0	10 ±10%	4.5	3.5	9.5	5.0	0.6
PTGL05AS3R9K2B51B0	30	269	340	452	530	3.5	3.9 ±10%	5.5	3.5	10.5	5.0	0.6
PTGL07AS2R7K2B51B0	30	336	425	565	663	4.5	2.7 ±10%	7.3	3.5	12.3	5.0	0.6
PTGL07AS1R8K2B51B0	30	420	532	708	829	5.0	1.8 ±10%	7.3	3.5	12.3	5.0	0.6
PTGL09AS1R2K2B51B0	30	556	704	936	1097	6.0	1.2 ±10%	9.3	3.5	14.3	5.0	0.6
PTGL12AS0R8K2B51B0	30	685	867	1153	1352	7.0	0.8 ±10%	11.5	3.5	16.5	5.0	0.6

Maximum Current shows typical capacities of the transformer which can be used.
 30V Series is recognized by UL.
 Taping type is also available. Please refer to the page of "Package" information for details.

■ Protective Threshold Current Range

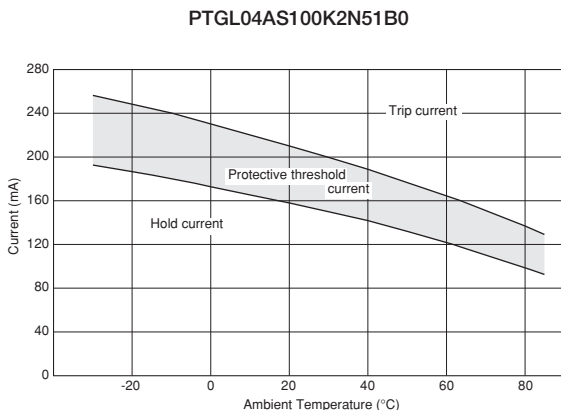

Continued on the following page. ↗

☐ Continued from the preceding page.

■ Protective Threshold Current Range

PTGL05AS3R9K2B51B0



PTGL07AS2R7K2B51B0



PTGL07AS1R8K2B51B0



PTGL09AS1R2K2B51B0



PTGL12AS0R8K2B51B0



■ Operating Time (Typical Curve)

PTGL04AS100K2N51B0



PTGL04AS100K2B51B0



Continued on the following page. ☐

Continued from the preceding page.

Operating Time (Typical Curve)

2

PTGL05AS3R9K2B51B0



PTGL07AS2R7K2B51B0



PTGL07AS1R8K2B51B0

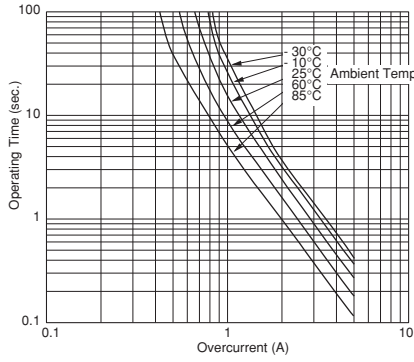

PTGL09AS1R2K2B51B0

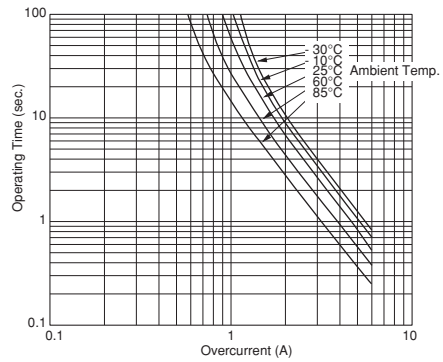

PTGL12AS0R8K2B51B0

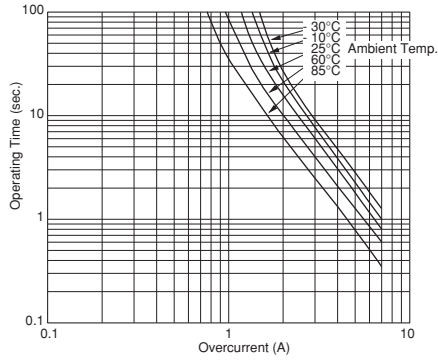

POSISTOR® for Circuit Protection



Overcurrent Protection Narrow Current Band 51/60V Series

This product is a leaded type PTC thermistor for overcurrent protection which is suitable for a current limiting resistor.

■ Features

1. Small fluctuation in the circuit due to resistance tolerance +/-10%
2. Narrow current range (less than twice) between operating and non-operating current at -10 to 60 degrees C.
3. Quick operating time due to small size compared with conventional products.
4. Best suited to meet the requirements for power supplies and motor protection. Error-free operations are assured by rush current.
5. Circuit is protected until current is turned off.
6. Restores the original low resistance value automatically once the overload is removed.
7. Non-contact design leads to long life and no noise.
 Durable and strong against mechanical vibration and shock because it is a solid element.

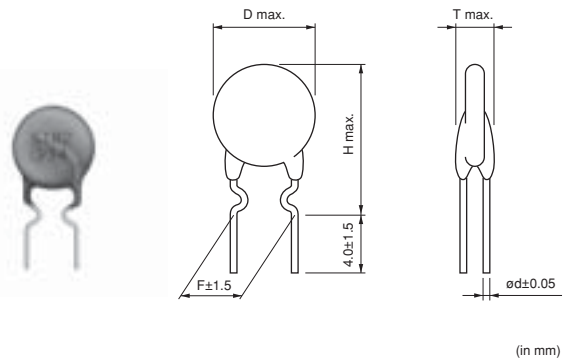

3

Part Number	Max. Voltage (V)	Hold Current (at +60°C) (mA)	Hold Current (at +25°C) (mA)	Trip Current (at +25°C) (mA)	Trip Current (at -10°C) (mA)	Max. Current (A)	Resistance (at +25°C) (ohm)	Body Diameter (D) (mm)	Thickness (T) (mm)	Height (H) (mm)	Lead Space (F) (mm)	Lead Diameter (phi d) (mm)
PTGL04AS100K3B51B0	51	168	213	283	332	1.0	10 ±10%	4.5	3.5	9.5	5.0	0.6
PTGL05AS6R8K3B51B0	51	197	249	331	388	1.5	6.8 ±10%	5.5	3.5	10.5	5.0	0.6
PTGL07AS3R3K3B51B0	51	307	389	517	606	3.0	3.3 ±10%	7.3	3.5	12.3	5.0	0.6
PTGL09AS2R2K3B51B0	51	412	522	694	814	4.0	2.2 ±10%	9.3	3.5	14.3	5.0	0.6
PTGL12AS1R2K3B51B0	51	592	749	996	1168	5.0	1.2 ±10%	11.5	3.5	16.5	5.0	0.6
PTGL04AS220K4N51B0	60	88	112	149	175	1.0	22 ±10%	4.5	3.5	9.5	5.0	0.5
PTGL04AS220K4B51B0	60	115	145	193	226	1.0	22 ±10%	4.5	3.5	9.5	5.0	0.6
PTGL05AS100K4B51B0	60	170	215	286	335	1.5	10 ±10%	5.5	3.5	10.5	5.0	0.6
PTGL07AS5R6K4N51B0	60	186	236	314	368	2.2	5.6 ±10%	7.3	3.5	12.3	5.0	0.5
PTGL07AS5R6K4B51B0	60	229	290	386	452	3.0	5.6 ±10%	7.3	3.5	12.3	5.0	0.6
PTGL09AS3R3K4B51B0	60	333	421	560	656	4.0	3.3 ±10%	9.3	3.5	14.3	5.0	0.6
PTGL12AS2R2K4B51B0	60	439	556	739	867	5.0	2.2 ±10%	11.5	3.5	16.5	5.0	0.6

Maximum Current shows typical capacities of the transformer which can be used.
 51/60V Series are recognized by UL.
 Taping type is also available. Please refer to the page of "Package" information for details.

3

■ Protective Threshold Current Range (51V Series)

PTGL04AS100K3B51B0



PTGL05AS6R8K3B51B0



PTGL07AS3R3K3B51B0



PTGL09AS2R2K3B51B0



PTGL12AS1R2K3B51B0



■ Protective Threshold Current Range (60V Series)

PTGL04AS220K4N51B0



PTGL04AS220K4B51B0



Continued on the following page. ↗

☐ Continued from the preceding page.

■ Protective Threshold Current Range (60V Series)

PTGL05AS100K4B51B0



PTGL07AS5R6K4N51B0



3

PTGL07AS5R6K4B51B0

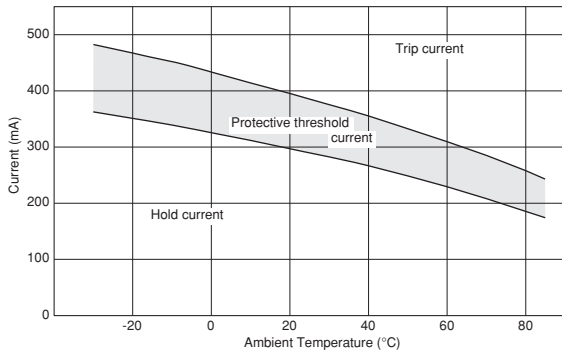

PTGL09AS3R3K4B51B0



PTGL12AS2R2K4B51B0



■ Operating Time 51V Series (Typical Curve)

PTGL04AS100K3B51B0



PTGL05AS6R8K3B51B0



Continued on the following page. ☐

Continued from the preceding page.

Operating Time 51V Series (Typical Curve)

PTGL07AS3R3K3B51B0



PTGL09AS2R2K3B51B0



PTGL12AS1R2K3B51B0



Operating Time 60V Series (Typical Curve)

PTGL04AS220K4N51B0



PTGL04AS220K4B51B0



PTGL05AS100K4B51B0



PTGL07AS5R6K4N51B0



Continued on the following page. ↗

☐ Continued from the preceding page.

■ Operating Time 60V Series (Typical Curve)

PTGL07AS5R6K4B51B0



PTGL09AS3R3K4B51B0



PTGL12AS2R2K4B51B0



3

POSISTOR® for Circuit Protection



Overcurrent Protection Narrow Current Band 140V Series

This product is a leaded type PTC thermistor for overcurrent protection which is suitable for a current limiting resistor.

4

■ Features

1. Small fluctuation in the circuit due to resistance tolerance +/-10%
2. Narrow current range (less than twice) between operating and non-operating current at -10 to 60 degrees C.
3. Quick operating time due to small size compared with conventional products.
4. Best suited to meet the requirements for power supplies and motor protection. Error-free operations are assured by rush current.
5. Circuit is protected until current is turned off.
6. Restores the original low resistance value automatically once the overload is removed.
7. Non-contact design leads to long life and no noise.
 Durable and strong against mechanical vibration and shock because it is a solid element.



Part Number	Max. Voltage (V)	Hold Current (at +60°C) (mA)	Hold Current (at +25°C) (mA)	Trip Current (at +25°C) (mA)	Trip Current (at -10°C) (mA)	Max. Current (A)	Resistance (at +25°C) (ohm)	Body Diameter (D) (mm)	Thickness (T) (mm)	Height (H) (mm)	Lead Space (F) (mm)	Lead Diameter (phi d) (mm)
PTGL04AS560K6B51B0	140	74	94	125	147	0.5	56 ±10%	4.5	4.5	9.5	5.0	0.6
PTGL05AS270K6B51B0	140	106	134	178	209	1.0	27 ±10%	5.5	4.5	10.5	5.0	0.6
PTGL07AS150K6B51B0	140	148	187	249	292	1.5	15 ±10%	7.3	4.5	12.3	5.0	0.6
PTGL09AS120K6B51B0	140	192	244	324	380	2.0	12 ±10%	9.3	4.5	14.3	5.0	0.6
PTGL09AS7R6K6B51B0	140	227	287	382	447	2.2	7.6 ±10%	9.3	4.5	14.3	5.0	0.6
PTGL12AS4R7K6B51B0	140	310	393	523	613	3.5	4.7 ±10%	11.5	4.5	16.5	5.0	0.6

Maximum Current shows typical capacities of the transformer which can be used.
 140V Series is recognized by UL.
 Taping type is also available. Please refer to the page of "Package" information for details.

■ Protective Threshold Current Range

PTGL04AS560K6B51B0



PTGL05AS270K6B51B0



Continued on the following page. ↗

Continued from the preceding page.

Protective Threshold Current Range

PTGL07AS150K6B51B0

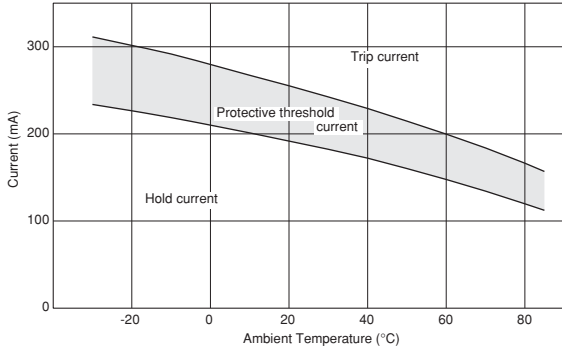

PTGL09AS120K6B51B0

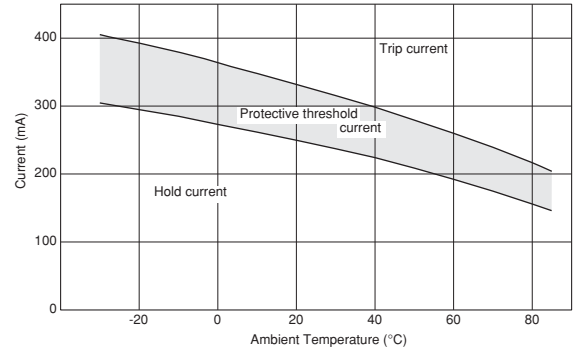

PTGL09AS7R6K6B51B0

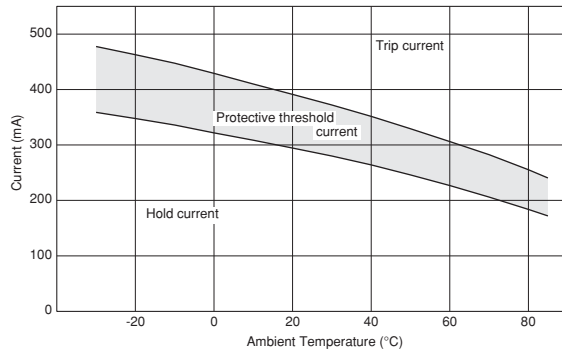

PTGL12AS4R7K6B51B0

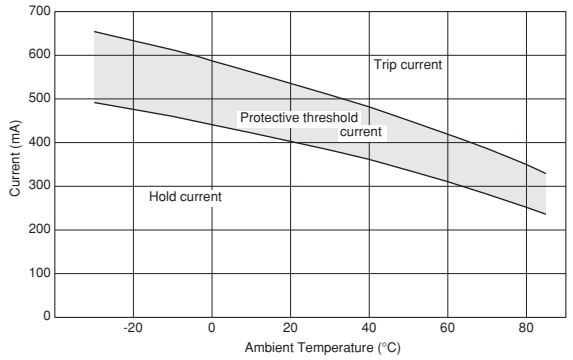

Operating Time (Typical Curve)

PTGL04AS560K6B51B0



PTGL05AS270K6B51B0



PTGL07AS150K6B51B0

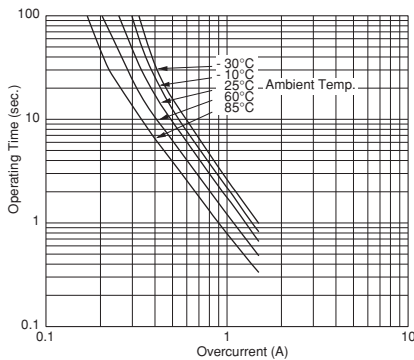

PTGL09AS120K6B51B0



Continued on the following page.

☐ Continued from the preceding page.

■ Operating Time (Typical Curve)

PTGL09AS7R6K6B51B0



PTGL12AS4R7K6B51B0

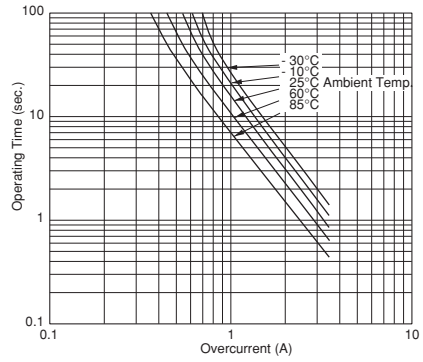

POSISTOR® for Circuit Protection



Overcurrent Protection 16V Series

This low-voltage, low-resistance type "POSISTOR" is a circuit protector whose resistance value in normal operation is very low and in abnormal situations like motor lock or short circuit, will be increased to restrain overcurrent. This "POSISTOR" is most suitable for low-voltage circuits.

■ Features

1. Best suited to meet the requirements for power supplies and motor protection. Error-free operation is assured by rush current.
2. Circuit is protected until current is turned off.
3. Restores the original low resistance value automatically once the overload is removed.
4. Non-contact design leads to long life and no noise. Durable and strong against mechanical vibration and shock because it is a solid element.



Part Number	Max. Voltage (V)	Hold Current (at +60°C) (mA)	Hold Current (at +25°C) (mA)	Trip Current (at +25°C) (mA)	Trip Current (at -10°C) (mA)	Max. Current (A)	Resistance (at +25°C) (ohm)	Body Diameter (D) (mm)	Thickness (T) (mm)	Height (H) (mm)	Lead Space (F) (mm)	Lead Diameter (phi d) (mm)
PTGL05AR1R0M1B51B0	16	370	470	880	1040	2.0	1.0 ±20%	6.0	3.5	9.5	5.0	0.6
PTGL06AR0R8M1B51B0	16	400	505	955	1120	3.0	0.8 ±20%	6.5	3.5	10.0	5.0	0.6
PTGL07ARR47M1B51B0	16	560	705	1310	1570	5.0	0.47 ±20%	7.5	3.5	12.0	5.0	0.6
PTGL09ARR33M1B51B0	16	680	875	1625	1900	7.0	0.33 ±20%	9.0	3.5	14.0	5.0	0.6
PTGL10ARR27M1B51B0	16	800	1025	1900	2250	8.0	0.27 ±20%	10.1	3.5	15.0	5.0	0.6
PTGL12AR0R2M1B51B0	16	1000	1300	2410	2800	9.0	0.2 ±20%	11.3	3.5	16.0	5.0	0.6
PTGL14ARR15M1B51B0	16	1200	1545	2855	3360	10	0.15 ±20%	13.5	3.5	18.5	5.0	0.6

Maximum Current shows typical capacities of the transformer which can be used.
 Taping type is also available(except PTGL14ARR15M1B51B0). Please refer to the page of "Package" information for details.

■ Protective Threshold Current Range (16V Series)

PTGL05AR1R0M1B51B0

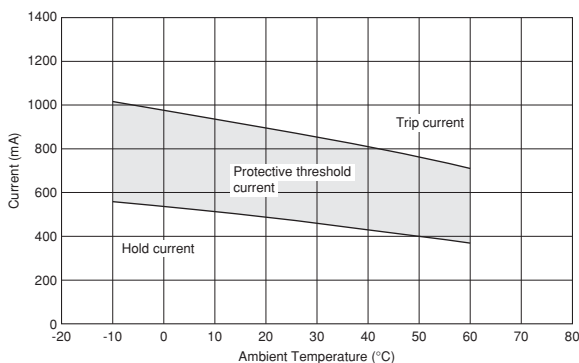

PTGL06AR0R8M1B51B0

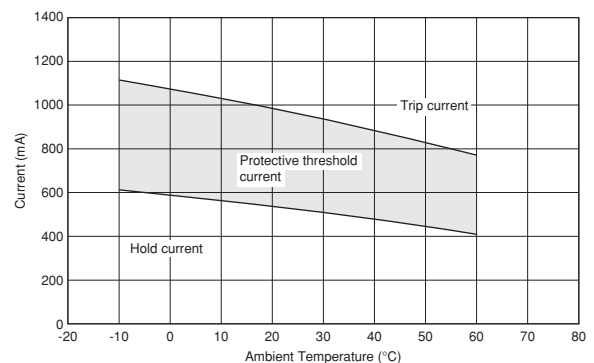

Continued on the following page.

☐ Continued from the preceding page.

■ Protective Threshold Current Range (16V Series)

PTGL07ARR47M1B51B0



PTGL09ARR33M1B51B0

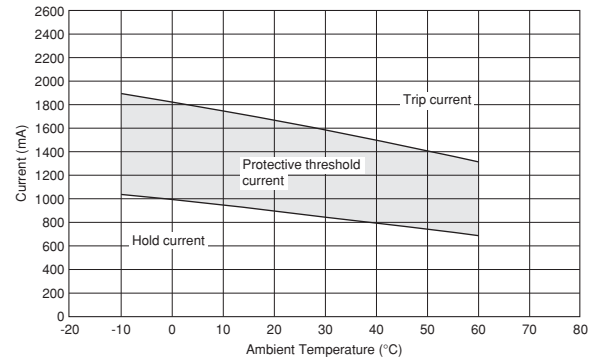

PTGL10ARR27M1B51B0



PTGL12AR0R2M1B51B0

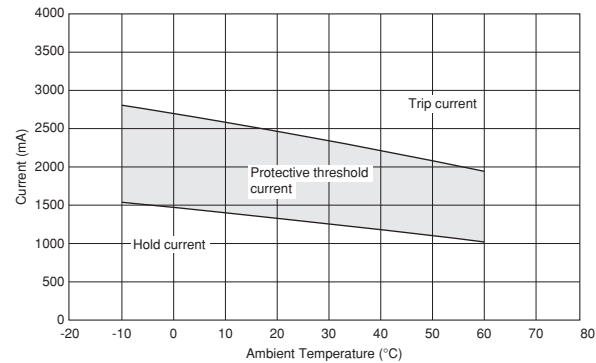

PTGL14ARR15M1B51B0



■ Operating Time 16V Series (Typical Curve)

PTGL05AR1R0M1B51B0



PTGL06AR0R8M1B51B0



Continued on the following page. ☐

5

Continued from the preceding page.

■ Operating Time 16V Series (Typical Curve)

PTGL07ARR47M1B51B0

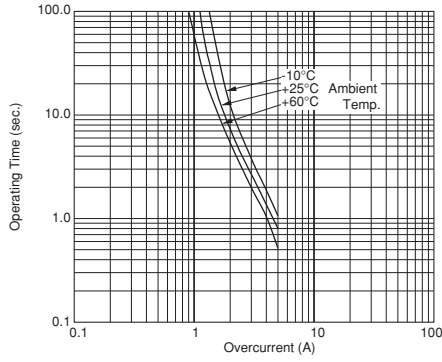

PTGL09ARR33M1B51B0



PTGL10ARR27M1B51B0

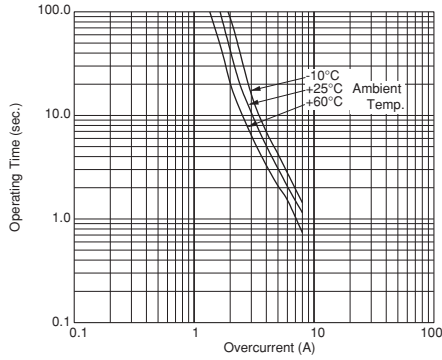

PTGL12AR0R2M1B51B0

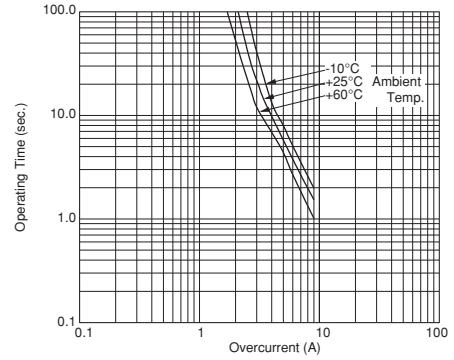

PTGL14ARR15M1B51B0

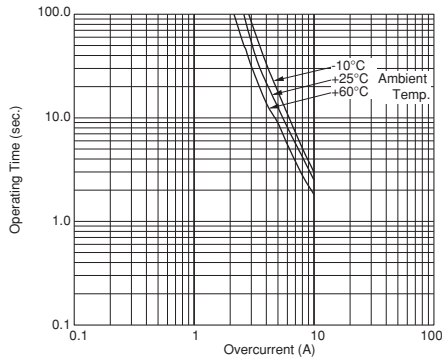

5

POSISTOR[®] for Circuit Protection



Overcurrent Protection 24/30/32V Series

The safety resistor "POSISTOR" is most suited to meet the requirements of the safety standard short-circuit tests such as IEC, VDE, BS, UL, CSA, etc., worldwide.

■ Features

1. Best suited to meet the requirements of the short-circuit test. Quick response compared with current fuse and resistor and error-free operation are assured.
2. Small size save board space. Capable of being mounted anywhere because replacement is not required.
3. Actuates by excessive current during the short-circuit test to restrain abnormal heat generation in other circuit components and printed boards. This state will be maintained until the abnormal state is removed or power is turned off to reset the "POSISTOR" to the original state. Surface temperature of "POSISTOR" is kept low, below a certain value, during the actuation.
4. Non-contact design leads to long life and no noise. Durable and strong against mechanical vibration and shock because it is a solid element.

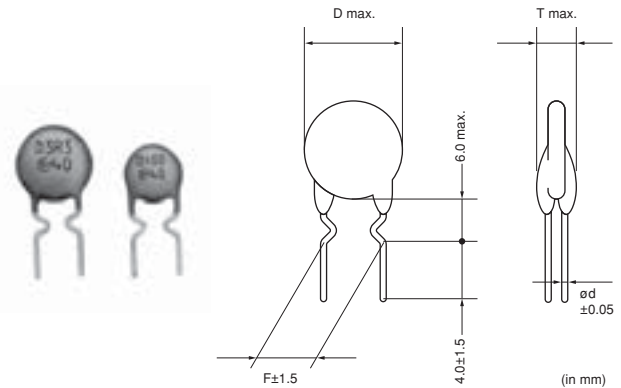

6

Part Number	Max. Voltage (V)	Hold Current (at +60°C) (mA)	Hold Current (at +25°C) (mA)	Trip Current (at +25°C) (mA)	Trip Current (at -10°C) (mA)	Max. Current (A)	Resistance (at +25°C) (ohm)	Body Diameter (D) (mm)	Thickness (T) (mm)	Lead Space (F) (mm)	Lead Diameter (phi d) (mm)
PTGL07BD100N2B51B0	24	80	124	251	320	2.0	10 ±30%	7.4	4.0	5.0	0.6
PTGL07BD6R8N2B51B0	24	90	139	296	370	2.0	6.8 ±30%	7.4	4.0	5.0	0.6
PTGL09BD4R7N2B51B0	24	120	216	398	500	2.0	4.7 ±30%	9.5	4.0	5.0	0.6
PTGL09BD3R3N2B51B0	24	140	248	461	580	2.0	3.3 ±30%	9.5	4.0	5.0	0.6
PTGL09BD2R2N2B51B0	24	180	326	431	710	2.0	2.2 ±30%	9.5	4.0	5.0	0.6
PTGL04AR130H2B51B0	30	145	180	350	400	0.7	13 ±25%	5.5	4.0	5.0	0.6
PTGL07AR4R6H2B51B0	30	250	340	610	700	2.0	4.6 ±25%	7.4	4.0	5.0	0.6
PTGL09AR1R8H2B51B0	30	410	510	970	1120	3.0	1.8 ±25%	9.5	4.0	5.0	0.6
PTGL12AR1R2H2B51B0	30	520	645	1225	1420	4.3	1.2 ±25%	12.0	4.0	5.0	0.6
PTGL13AR0R8H2B71B0	30	680	870	1600	1900	5.5	0.8 ±25%	13.5	4.0	7.5	0.6
PTGL07BD470N3B51B0	32	30	55	115	140	1.5	47 ±30%	7.4	4.0	5.0	0.6
PTGL07BD330N3B51B0	32	40	60	135	170	1.5	33 ±30%	7.4	4.0	5.0	0.6
PTGL07BD220N3B51B0	32	45	75	160	200	1.5	22 ±30%	7.4	4.0	5.0	0.6
PTGL07BD150N3B51B0	32	60	100	195	240	1.5	15 ±30%	7.4	4.0	5.0	0.6

Maximum Current shows typical capacities of the transformer which can be used.

24/30/32V Series are recognized by UL (except PTGL13AR0R8H2B71B0).

Only PTGL_51B0 series are available in taping type (except PTGL12AR1R2H2B51B0). Please refer to the page of "Package" information for details.

■ Protective Threshold Current Range (24V Series)

PTGL07BD100N2B51B0



PTGL07BD6R8N2B51B0



PTGL09BD4R7N2B51B0



PTGL09BD3R3N2B51B0



PTGL09BD2R2N2B51B0



6

■ Protective Threshold Current Range (30V Series)

PTGL04AR130H2B51B0

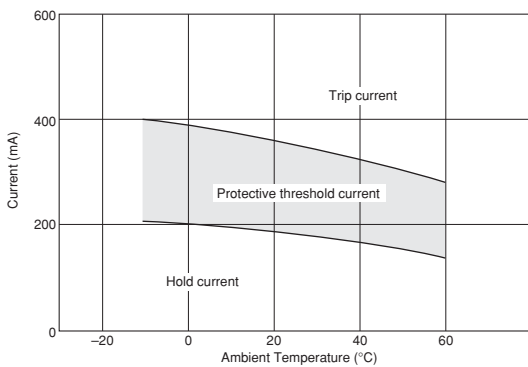

PTGL07AR4R6H2B51B0

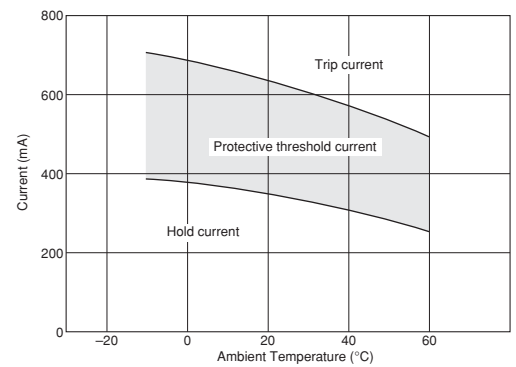

Continued on the following page. ↗

Continued from the preceding page.

Protective Threshold Current Range (30V Series)

PTGL09AR1R8H2B51B0



PTGL12AR1R2H2B51B0

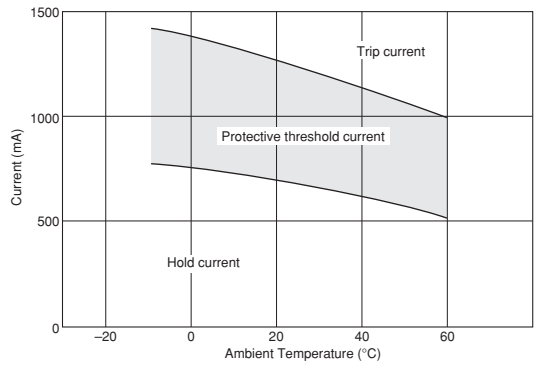

PTGL13AR0R8H2B71B0



6

Protective Threshold Current Range (32V Series)

PTGL07BD470N3B51B0



PTGL07BD330N3B51B0

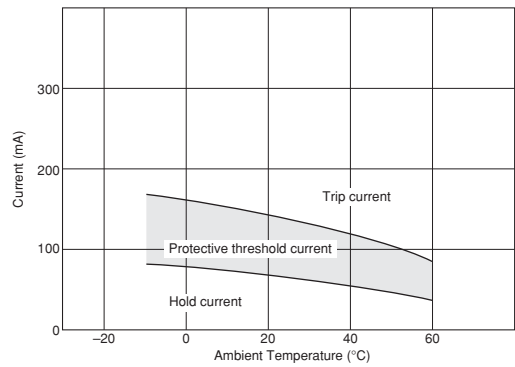

PTGL07BD220N3B51B0

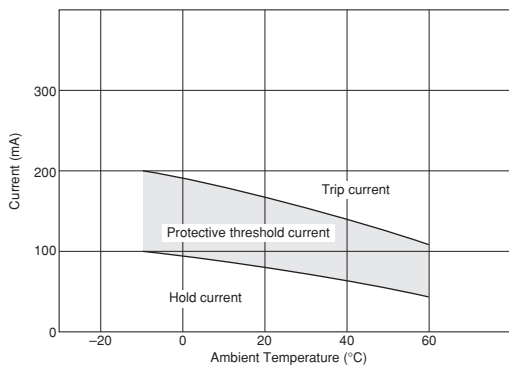

PTGL07BD150N3B51B0

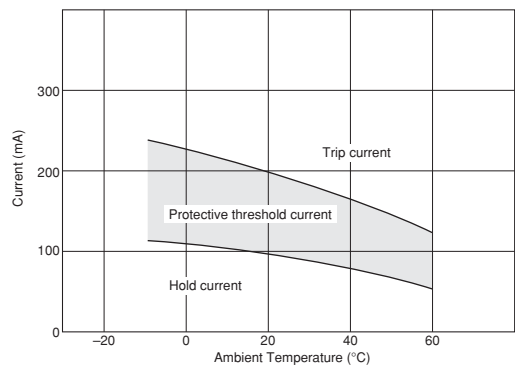

■ Operating Time 24V Series (Typical Curve)

PTGL07BD100N2B51B0

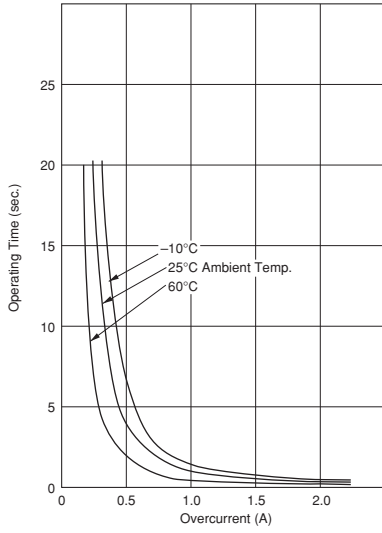

PTGL07BD6R8N2B51B0

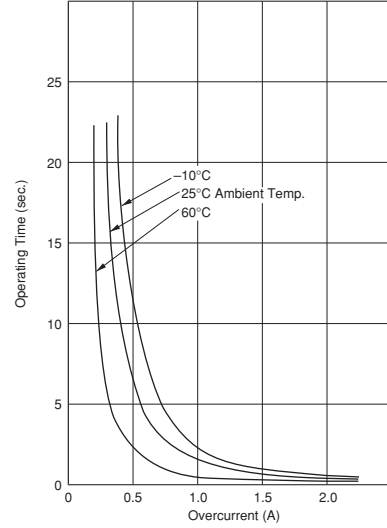

PTGL09BD4R7N2B51B0

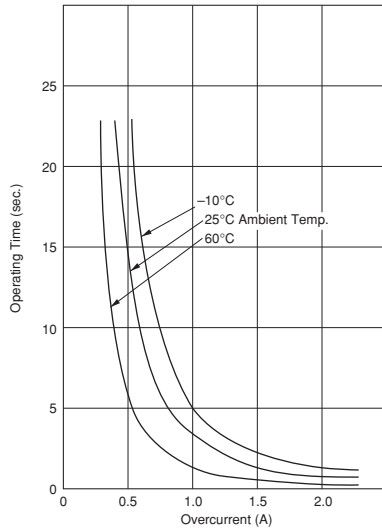

PTGL09BD3R3N2B51B0

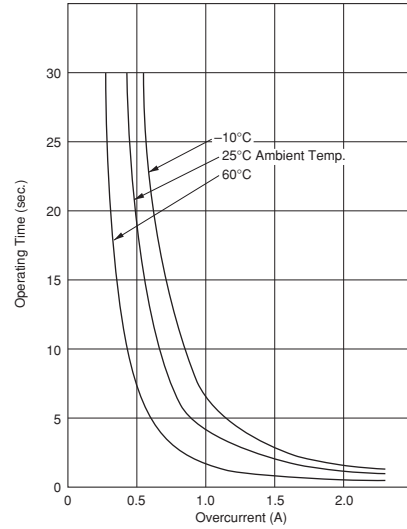

PTGL09BD2R2N2B51B0

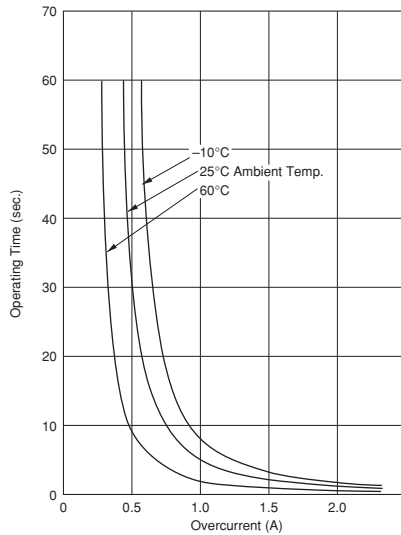

6

■ Operating Time 30V Series (Typical Curve)

PTGL04AR130H2B51B0



PTGL07AR4R6H2B51B0



PTGL09AR1R8H2B51B0

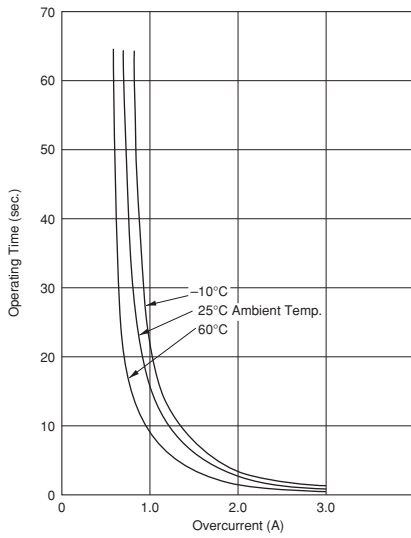

PTGL12AR1R2H2B51B0

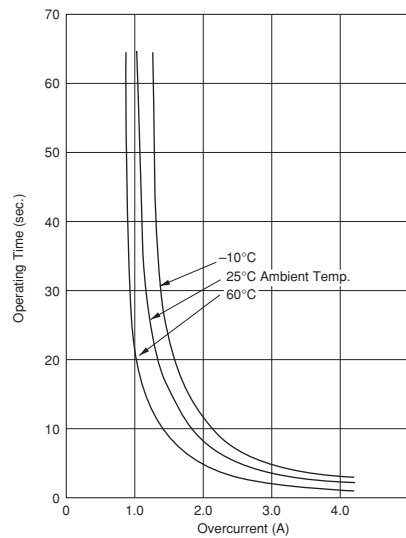

PTGL13AR0R8H2B71B0

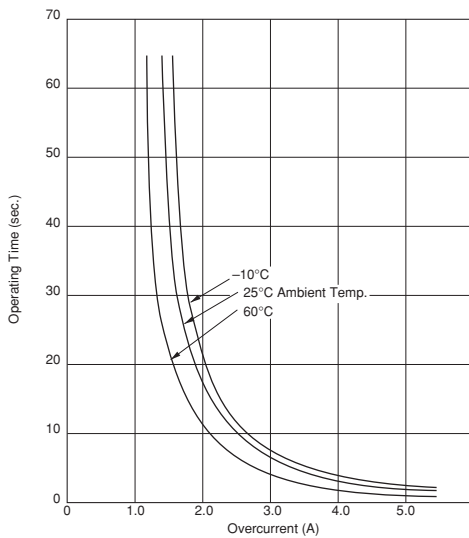

■ Operating Time 32V Series (Typical Curve)

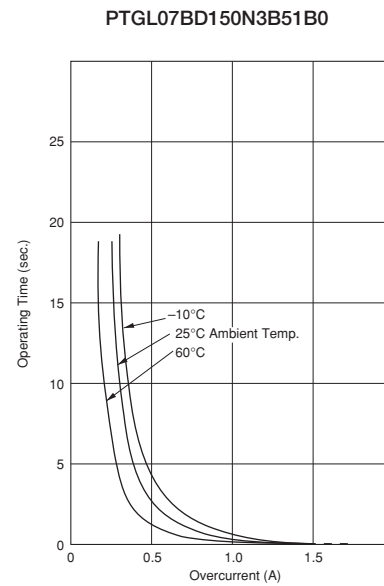
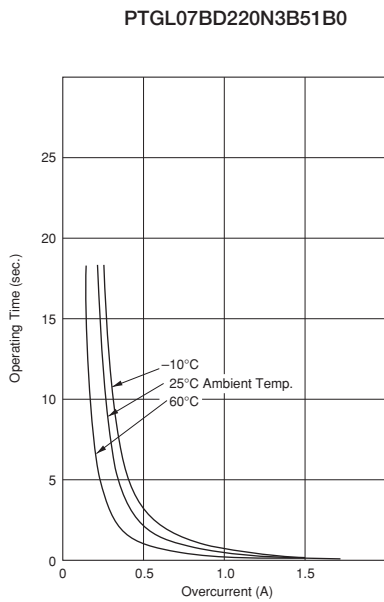
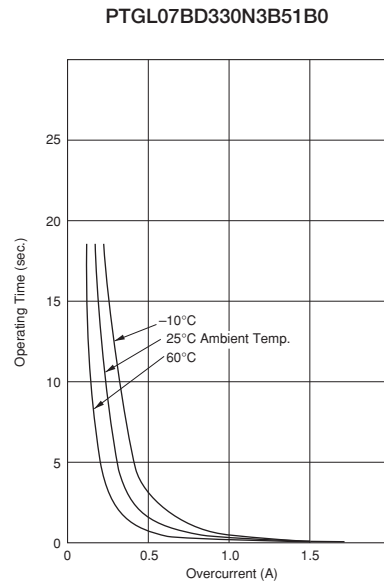
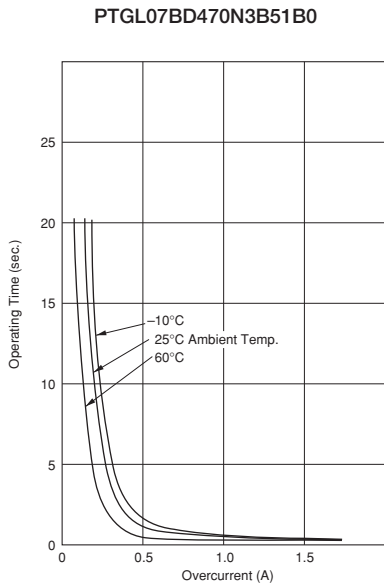

6

■ Application Circuit

(1) Short - Circuit Test of Transistor



(2) Short - Circuit Test of Diode



Continued on the following page. ↗

☞ Continued from the preceding page.

■ Application Circuit

(3) Short - Circuit Test of IC



(4) Short - Circuit Test of Electrolytic Capacitor

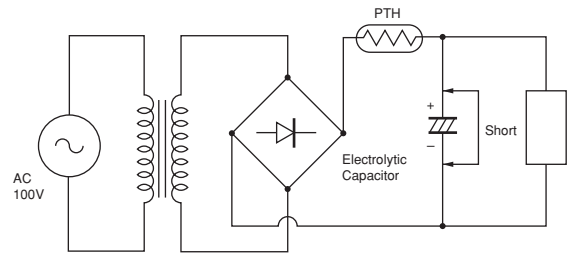

(5) Lock Test of Motor



(6) Transistor Protection Circuit



(7) Transformer Protection Circuit



6

POSISTOR[®] for Circuit Protection



Overcurrent Protection 56/80V Series

"POSISTOR" is a circuit protector whose resistance value in normal operation is very low and in abnormal situations like overcurrent or overheating, will be increased to restrain overcurrent. "POSISTOR" can be used for overcurrent protection against current fuse or temperature fuse, due to its ability to return to its initial condition when overcurrent is removed.

■ Features

1. Best suited to meet the requirements for power supplies and motor protection. Error-free operations are assured by rush current.
2. Circuit is protected until current is turned off.
3. Restores the original low resistance value automatically once the overload is removed.
4. Non-contact design leads to long life and no noise. Durable and strong against mechanical vibration and shock because it is a solid element.

■ Applications

1. DC cooling fan motors in office equipment, e.g., computers, facsimiles, floppy disk drives and power units.
2. DC drive motors in VTRs and cassette tape recorders. Power transformers (at secondary winding)



(in mm)

7

Part Number	Max. Voltage (V)	Hold Current (at +60°C) (mA)	Hold Current (at +25°C) (mA)	Trip Current (at +25°C) (mA)	Trip Current (at -10°C) (mA)	Max. Current (A)	Resistance (at +25°C) (ohm)	Body Diameter (D) (mm)	Thickness (T) (mm)	Lead Space (F) (mm)	Lead Diameter (phi d) (mm)
PTGL07AR220M3P51B0	56	90	115	205	240	1.0	22 ±20%	7.4	4.0	5.0	0.6
PTGL07AR8R2M3P51B0	56	130	165	300	350	1.0	8.2 ±20%	7.4	4.0	5.0	0.6
PTGL09AR150M3B51B0	56	150	190	340	400	1.2	15 ±20%	9.5	4.0	5.0	0.6
PTGL10AR3R9M3P51B0	56	210	260	470	550	2.0	3.9 ±20%	10.5	4.0	5.0	0.6
PTGL09AR4R7M3B51B0	56	270	350	600	700	2.0	4.7 ±20%	9.5	4.0	5.0	0.6
PTGL10AR3R9M3B51B0	56	300	390	680	800	2.0	3.9 ±20%	10.5	4.0	5.0	0.6
PTGL14AR3R3M3B71B0	56	380	490	830	980	2.5	3.3 ±20%	14.5	4.0	7.5	0.6
PTGL05AR550H4P51B0	80	50	62	115	135	0.7	55 ±25%	5.5	4.5	5.0	0.6
PTGL07AR250H4B51B0	80	110	140	260	300	1.0	25 ±25%	7.4	4.5	5.0	0.6
PTGL09AR9R4H4B51B0	80	190	240	450	530	3.0	9.4 ±25%	9.5	4.5	5.0	0.6
PTGL12AR5R6H4B71B0	80	270	350	650	760	4.3	5.6 ±25%	12.0	4.5	7.5	0.6
PTGL13AR3R7H4B71B0	80	310	405	750	860	5.5	3.7 ±25%	13.5	4.5	7.5	0.6

Maximum Current shows typical capacities of the transformer which can be used.

Please contact us for UL recognized products.

Only PTGL_51B0 type is available in taping type. Please refer to the page of "Package" information for details.

■ Protective Threshold Current Range (56V Series)

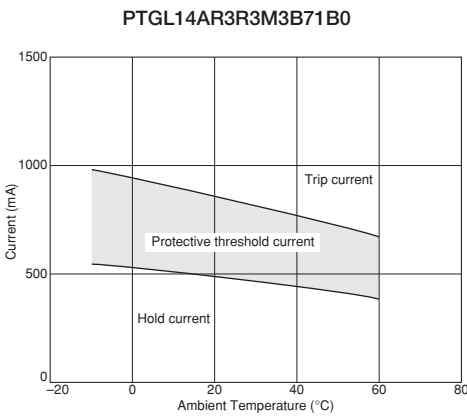
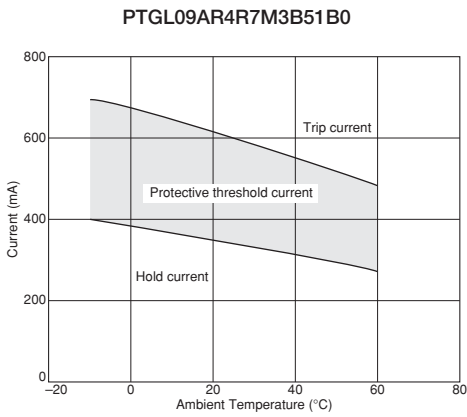
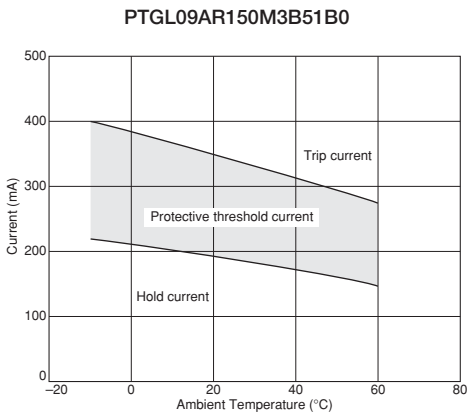
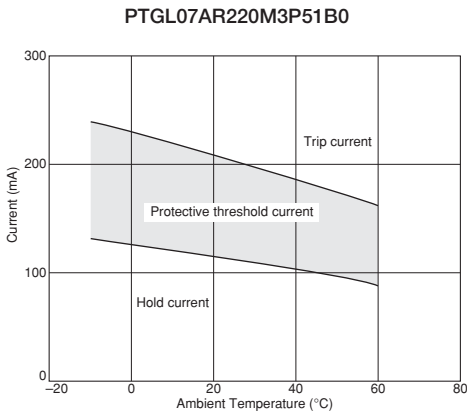

7

■ Protective Threshold Current Range (80V Series)

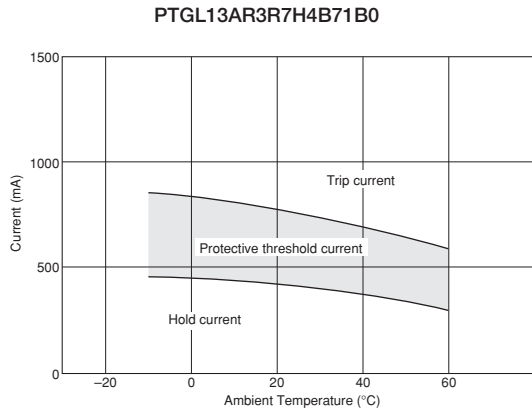
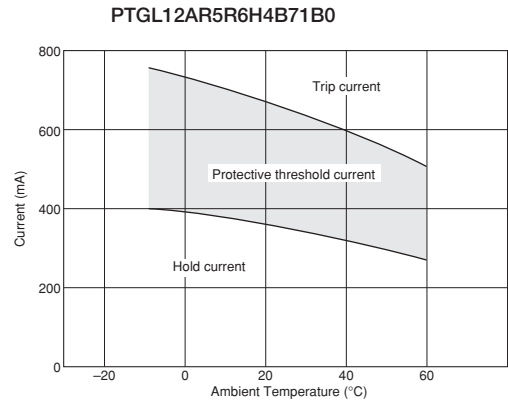
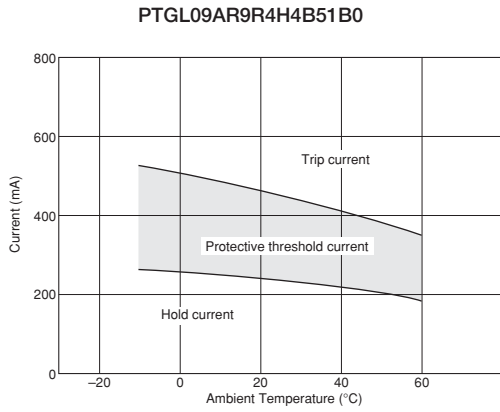
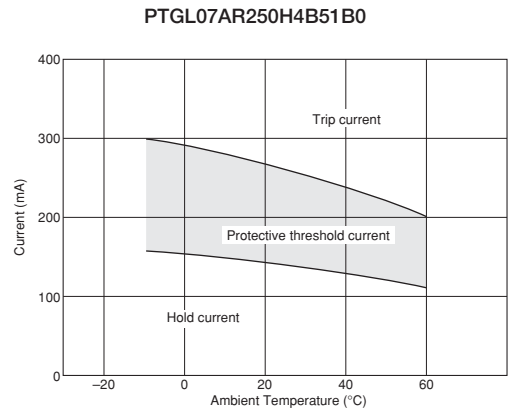

7

■ Operating Time 56V Series (Typical Curve)

PTGL07AR220M3P51B0

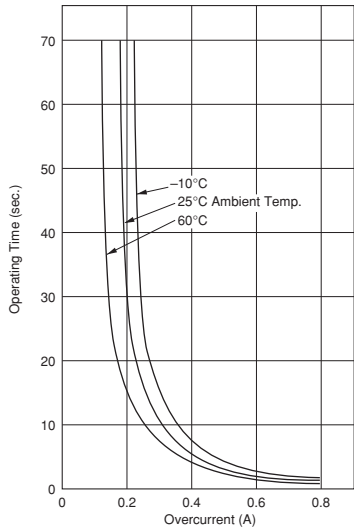

PTGL07AR8R2M3P51B0

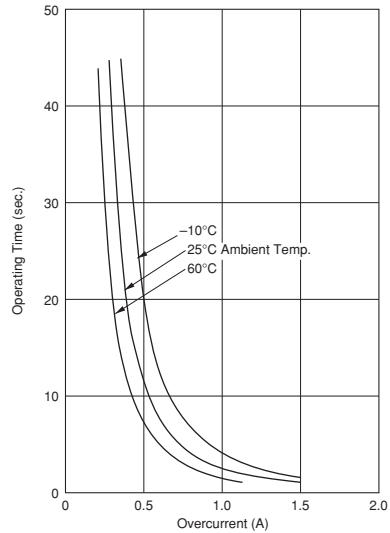

PTGL09AR150M3B51B0

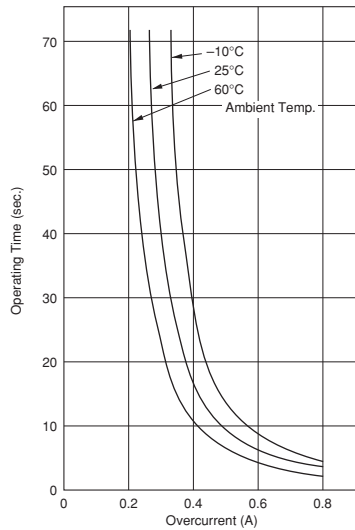

PTGL10AR3R9M3P51B0

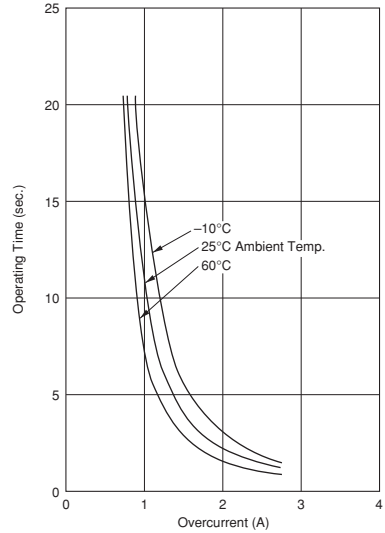

PTGL09AR4R7M3B51B0

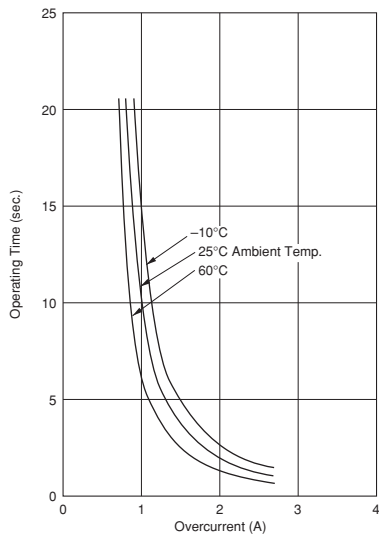

PTGL10AR3R9M3B51B0

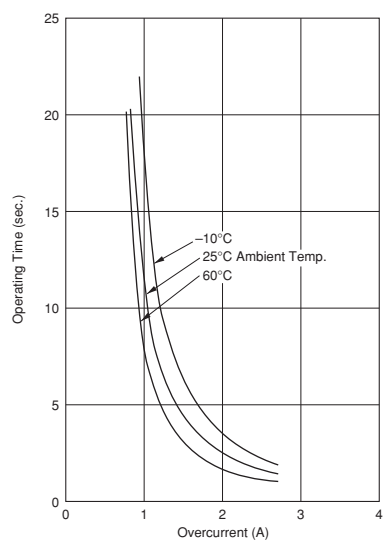

Continued on the following page. ↗

Continued from the preceding page.

■ Operating Time 56V Series (Typical Curve)

PTGL14AR3R3M3B71B0



■ Operating Time 80V Series (Typical Curve)

PTGL05AR550H4P51B0



PTGL07AR250H4B51B0

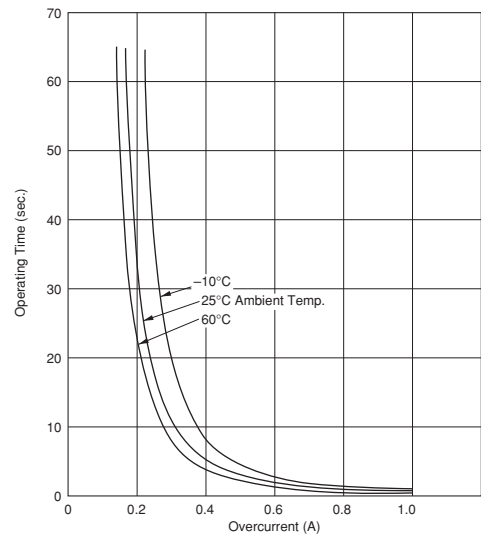

PTGL09AR9R4H4B51B0

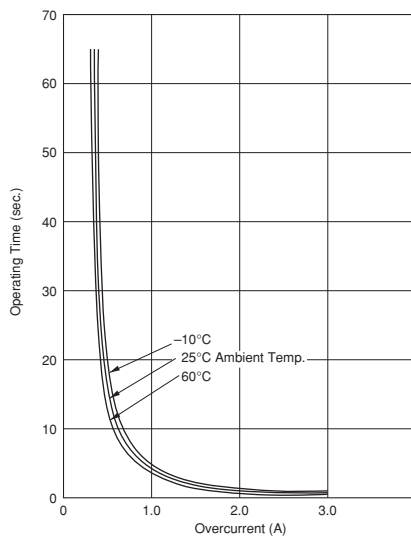

PTGL12AR5R6H4B71B0

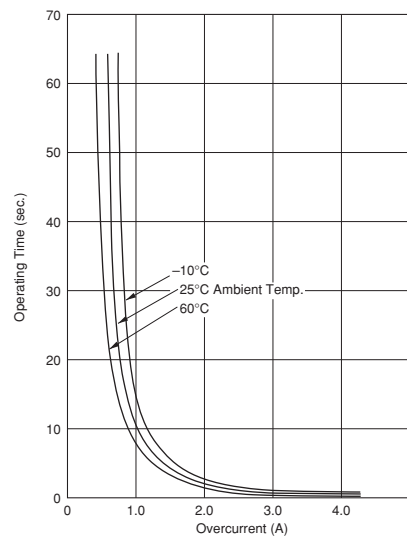

Continued on the following page. ↗

Continued from the preceding page.

Operating Time 80V Series (Typical Curve) PTGL13AR3R7H4B71B0



Application Circuit

(1) DC Motor Protection Circuit



(2) Transistor Protection Circuit

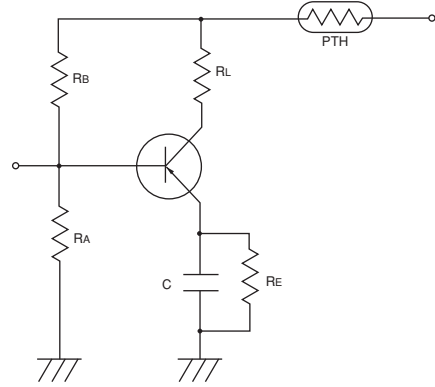

(3) Transformer Protection Circuit



7

POSISTOR[®] for Circuit Protection



Overcurrent Protection 125/140V Series

"POSISTOR" is a circuit protector whose resistance value in normal operation is very low and in abnormal situations like overcurrent or overheating, will be increased to restrain overcurrent. "POSISTOR" can be used for overcurrent protection against current fuse or temperature fuse, due to its ability to return to its initial condition when overcurrent is removed.

■ Features

1. Best suited to meet the requirements for power supplies and motor protection. Error-free operations are assured by rush current.
2. Circuit is protected until current is turned off.
3. Restores the original low resistance value automatically once the overload is removed.
4. Non-contact design leads to long life and no noise. Durable and strong against mechanical vibration and shock because it is a solid element.

■ Applications

Circuit Protection :

1. Transformers
2. Transistors
3. Fluorescent Lamps



Part Number	Max. Voltage (V)	Hold Current (at +60°C) (mA)	Hold Current (at +25°C) (mA)	Trip Current (at +25°C) (mA)	Trip Current (at -10°C) (mA)	Max. Current (A)	Resistance (at +25°C) (ohm)	Body Diameter (D) (mm)	Thickness (T) (mm)	Lead Space (F) (mm)	Lead Diameter (phi d) (mm)
PTGL05AR181M7P52B0	125	30	38	64	75	0.3	180 ±20%	6.0	5.0	5.0	0.6
PTGL07AR750M7B52B0	125	65	82	142	165	0.3	75 ±20%	8.0	6.0	5.0	0.6
PTGL09AR470M6B52B0	125	90	120	200	230	0.5	47 ±20%	10.0	5.5	5.0	0.6
PTGL09AR220M6B52B0	125	135	175	290	340	0.8	22 ±20%	10.0	5.5	5.0	0.6
PTGL12AR150M6B72B0	125	175	220	380	440	1.0	15 ±20%	12.5	5.5	7.5	0.6
PTGL14AR100M6B72B0	125	220	280	475	550	1.2	10 ±20%	15.0	5.5	7.5	0.6
PTGL18AR6R8M6B72B0	125	300	380	640	750	1.4	6.8 ±20%	18.5	5.5	7.5	0.6
PTGL18AR4R7M6B72B0	125	360	450	775	900	1.7	4.7 ±20%	18.5	5.5	7.5	0.6
PTGL18AR3R3M6B72B0	125	420	540	900	1050	2.0	3.3 ±20%	18.5	5.5	7.5	0.6
PTGL07AR330M6A51B0	140	100	130	200	230	0.5	33 ±20%	7.4	6.0	5.0	0.5
PTGL09AR220M6C61B0	140	140	180	280	330	1.0	22 ±20%	9.6	6.0	6.5	0.65
PTGL10AR150M6C61B0	140	170	220	345	400	1.0	15 ±20%	11.6	6.0	6.5	0.65
PTGL12AR100M6C01B0	140	220	290	440	510	1.0	10 ±20%	13.0	6.0	10.0	0.65
PTGL13AR6R8M6C01B0	140	290	370	575	670	1.0	6.8 ±20%	14.0	6.0	10.0	0.65
PTGL16AR5R6M6C01B0	140	340	440	670	780	2.0	5.6 ±20%	17.0	6.0	10.0	0.65

Maximum Current shows typical capacities of the transformer which can be used.
 Please contact us for UL recognized products.
 Only PTGL_52B0 type is available in taping type. Please refer to the page of "Package" information for details.

■ Protective Threshold Current Range (125V Series)

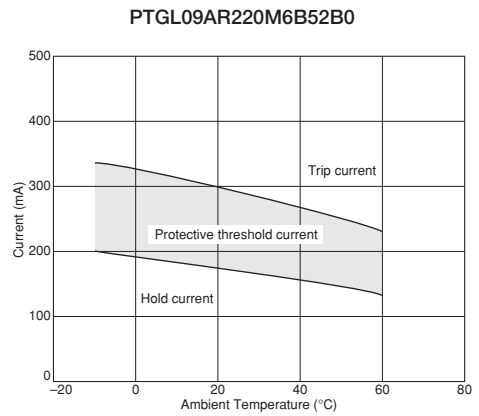
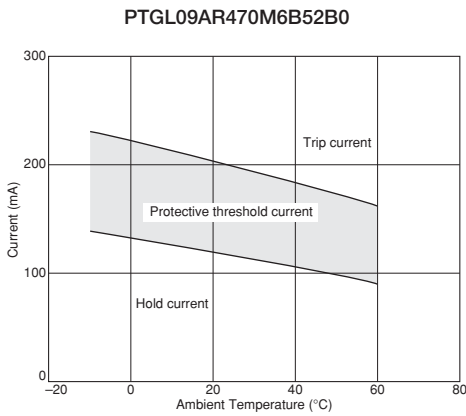
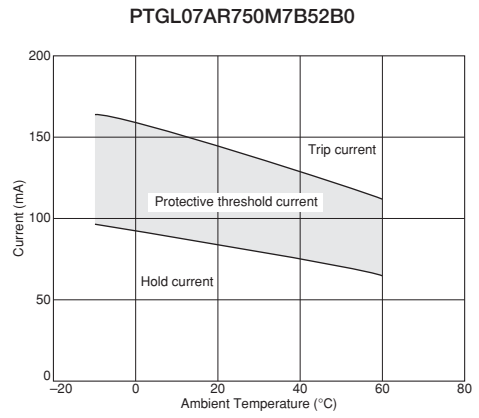
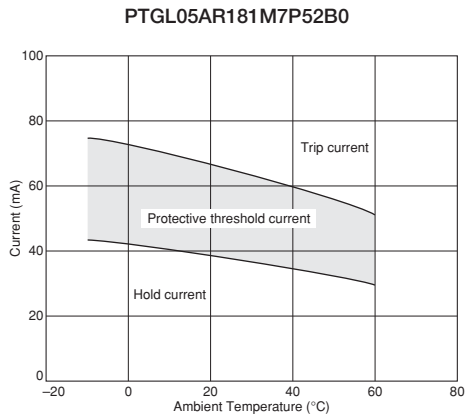

Continued on the following page. ↗

Continued from the preceding page.

■ Protective Threshold Current Range (125V Series)

PTGL18AR3R3M6B72B0



■ Protective Threshold Current Range (140V Series)

PTGL07AR330M6A51B0



PTGL09AR220M6C61B0



PTGL10AR150M6C61B0



PTGL12AR100M6C01B0



PTGL13AR6R8M6C01B0



PTGL16AR5R6M6C01B0



■ Operating Time 125V Series (Typical Curve)

PTGL05AR181M7P52B0



PTGL07AR750M7B52B0

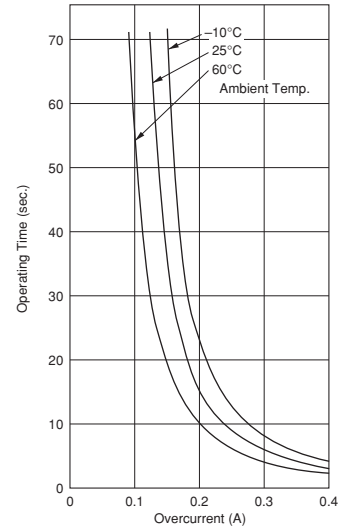

PTGL09AR470M6B52B0

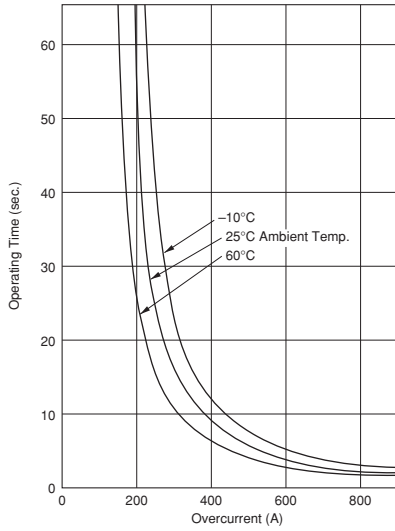

PTGL09AR220M6B52B0

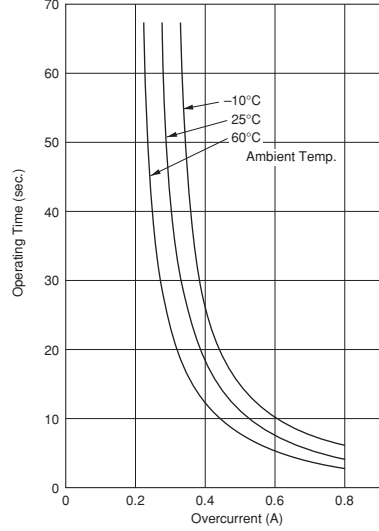

PTGL12AR150M6B72B0



PTGL14AR100M6B72B0

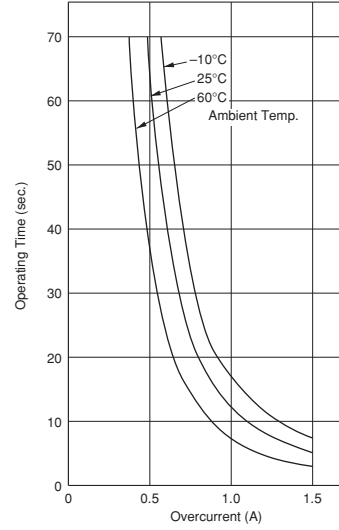

Continued on the following page. ↗

Continued from the preceding page.

■ Operating Time 125V Series (Typical Curve)

PTGL18AR6R8M6B72B0



PTGL18AR4R7M6B72B0

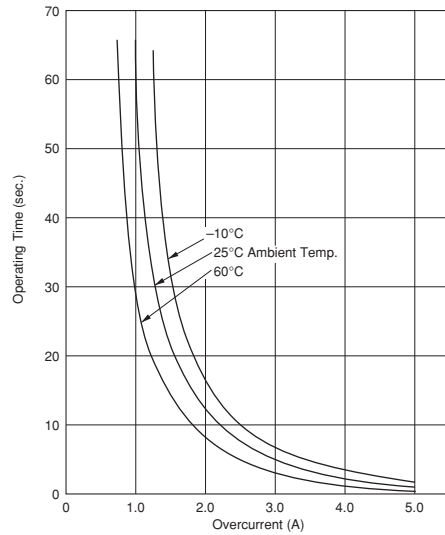

PTGL18AR3R3M6B72B0

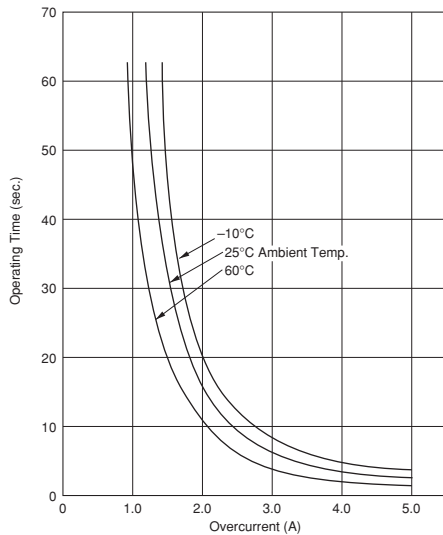

■ Operating Time 140V Series (Typical Curve)

PTGL07AR330M6A51B0

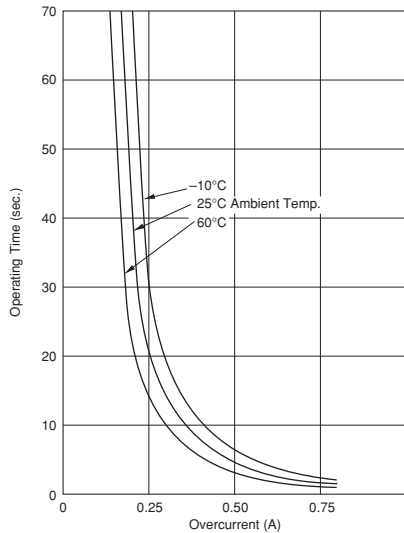

PTGL09AR220M6C61B0

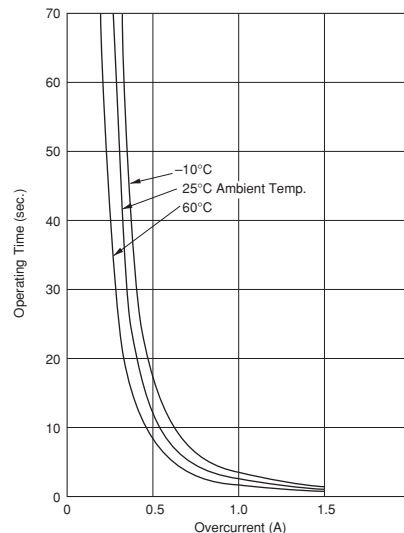

Continued on the following page. ↗

Continued from the preceding page.

Operating Time 140V Series (Typical Curve)

PTGL10AR150M6C61B0



PTGL12AR100M6C01B0



PTGL13AR6R8M6C01B0



PTGL16AR5R6M6C01B0



■ Application Circuit

(1) Transformer Protection Circuit 1



(2) Transformer Protection Circuit 2



(3) Transistor Protection Circuit



(4) Fluorescent Lamp Protection Circuit

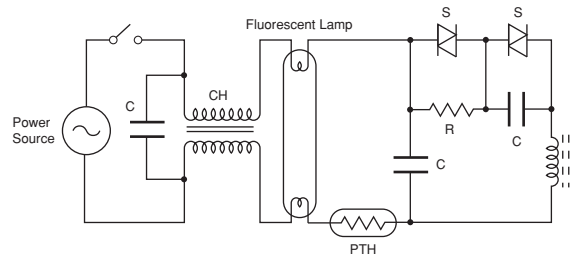

POSISTOR[®] for Circuit Protection



Overcurrent Protection 250/265V Series

"POSISTOR" is a circuit protector whose resistance value in normal operation is very low and in abnormal situations like overcurrent or overheating, will be increased to restrain overcurrent. "POSISTOR" can be used for overcurrent protection against current fuse or temperature fuse, due to its ability to return to its initial condition when overcurrent is removed.

■ Features

1. Best suited to meet the requirements for power supplies and motor protection. Error-free operations are assured by rush current.
2. Circuit is protected until current is turned off.
3. Restores the original low resistance value automatically once the overload is removed.
4. Non-contact design leads to long life and no noise. Durable and strong against mechanical vibration and shock because it is a solid element.

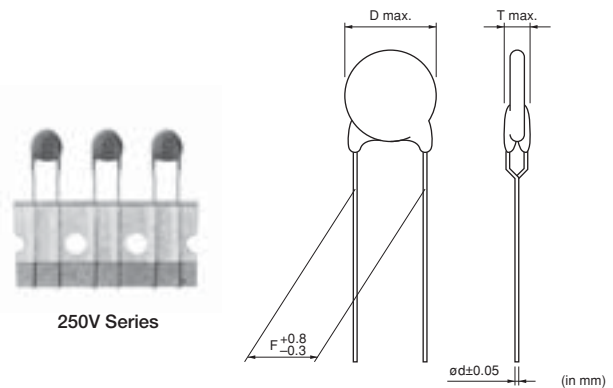

250V Series



265V Series (PTGL_1B0)

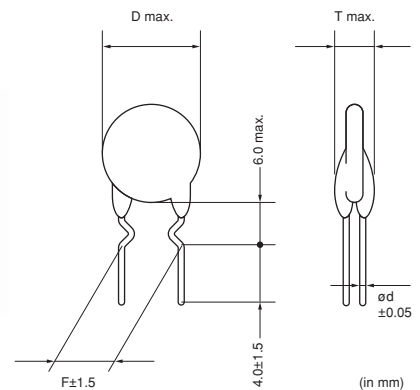

265V Series (PTGL_2B0)

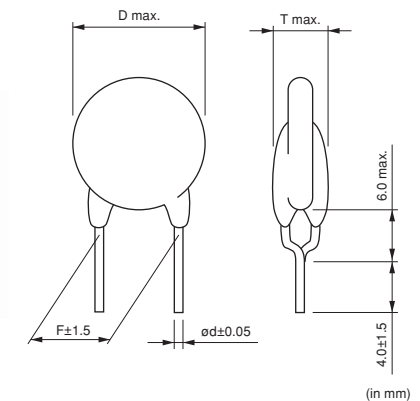

Part Number	Max. Voltage (V)	Hold Current (at +60°C) (mA)	Hold Current (at +25°C) (mA)	Trip Current (at +25°C) (mA)	Trip Current (at -10°C) (mA)	Max. Current (A)	Resistance (at +25°C) (ohm)	Body Diameter (D) (mm)	Thickness (T) (mm)	Lead Space (F) (mm)	Lead Diameter (phi d) (mm)
PTGL07BB220N0B52A0	250	90	130	250	300	0.5	22 ±30%	8.0	6.0	5.0	0.6
PTGL10BB120N0P52A0	250	90	130	250	300	0.6	12 ±30%	11.0	6.0	5.0	0.6
PTGL09AR390N0B52A0	250	100	115	245	280	0.6	39 ±30%	10.0	6.0	5.0	0.6
PTGL05AR151H8P52B0	265	28	35	65	78	0.2	150 ±25%	6.0	6.0	5.0	0.6
PTGL05AR181M9N51B0	265	29	37	60	70	0.3	180 ±20%	6.5	6.5	5.0	0.5
PTGL05AR121M9N51B0	265	35	47	75	85	0.3	120 ±20%	6.5	6.5	5.0	0.5
PTGL07AR820M9A51B0	265	60	75	125	150	0.5	82 ±20%	8.2	6.5	5.0	0.5
PTGL07AR700H8B52B0	265	66	85	160	185	0.4	70 ±25%	8.0	6.0	5.0	0.6
PTGL07AR650H8B52B0	265	68	84	162	190	1.0	65 ±25%	8.0	6.0	5.0	0.6
PTGL07AR450H8B52B0	265	80	105	200	220	1.0	45 ±25%	8.0	6.0	5.0	0.6
PTGL07AR560M9A51B0	265	80	95	165	190	0.8	56 ±20%	8.2	6.5	5.0	0.5

Continued on the following page. ↗

Continued from the preceding page.

Part Number	Max. Voltage (V)	Hold Current (at +60°C) (mA)	Hold Current (at +25°C) (mA)	Trip Current (at +25°C) (mA)	Trip Current (at -10°C) (mA)	Max. Current (A)	Resistance (at +25°C) (ohm)	Body Diameter (D) (mm)	Thickness (T) (mm)	Lead Space (F) (mm)	Lead Diameter (phi d) (mm)
PTGL09AR390M9C61B0	265	100	130	210	240	1.2	39 ±20%	10.0	6.5	6.5	0.65
PTGL09AR250H8B52B0	265	118	150	290	330	1.0	25 ±25%	10.0	6.0	5.0	0.6
PTGL12AR270M9C01B0	265	150	200	310	360	1.5	27 ±20%	14.0	6.5	10.0	0.65
PTGL12AR150H8B72B0	265	165	210	400	460	1.5	15 ±25%	12.5	6.0	7.5	0.6
PTGL14AR180M9C01B0	265	180	230	380	440	1.8	18 ±20%	15.7	6.5	10.0	0.65
PTGL13AR100H8B72B0	265	200	260	480	560	2.2	10 ±25%	14.0	6.0	7.5	0.6
PTGL18AR6R0H8B72B0	265	300	380	715	830	4.1	6.0 ±25%	18.5	6.0	7.5	0.6

Maximum Current shows typical capacities of the transformer which can be used.

250/265V Series are recognized by UL.

Only PTGL_52B0 type is available in taping type. Please refer to the page of "Package" information for details.

Protective Threshold Current Range (250V Series)

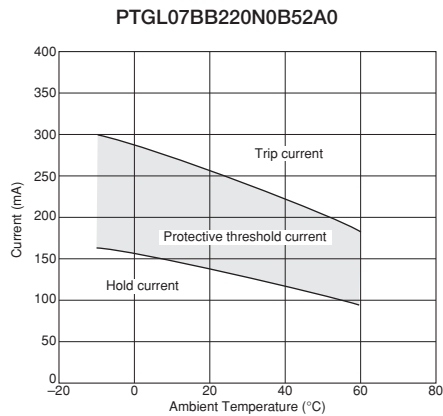

Protective Threshold Current Range (265V Series)



Continued on the following page. ↗

Continued from the preceding page.

■ Protective Threshold Current Range (265V Series)

PTGL05AR121M9N51B0



PTGL07AR820M9A51B0



PTGL07AR700H8B52B0



PTGL07AR650H8B52B0



PTGL07AR450H8B52B0



PTGL07AR560M9A51B0



PTGL09AR390M9C61B0



PTGL09AR250H8B52B0

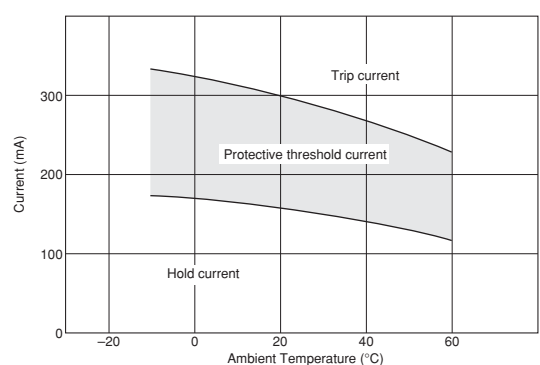

Continued on the following page. ↗

9

Continued from the preceding page.

■ Protective Threshold Current Range (265V Series)

PTGL12AR270M9C01B0



PTGL12AR150H8B72B0

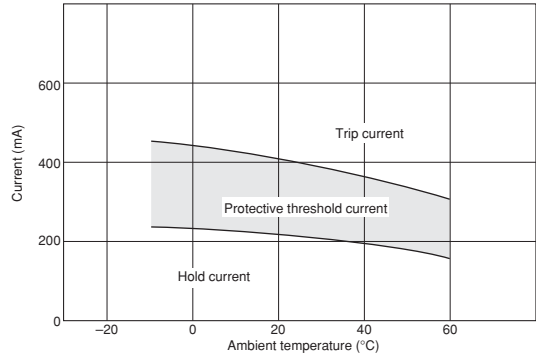

PTGL14AR180M9C01B0



PTGL13AR100H8B72B0



PTGL18AR6R0H8B72B0



■ Operating Time 250V Series (Typical Curve)

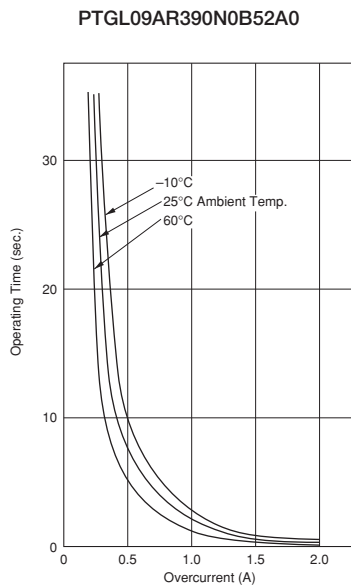
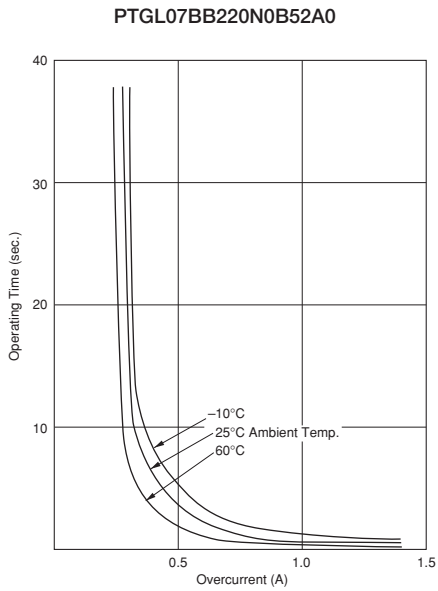

■ Operating Time 265V Series (Typical Curve)



Continued on the following page. ↗

☐ Continued from the preceding page.

■ Operating Time 265V Series (Typical Curve)

PTGL05AR121M9N51B0



PTGL07AR820M9A51B0



PTGL07AR700H8B52B0

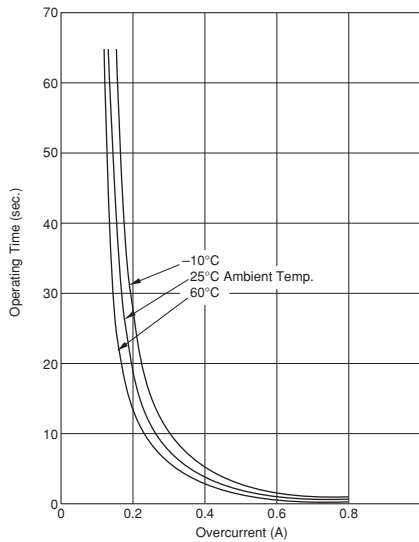

PTGL07AR650H8B52B0



PTGL07AR450H8B52B0

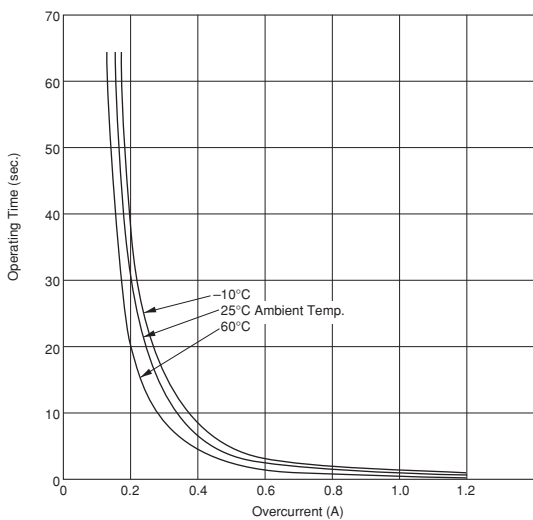

PTGL07AR560M9A51B0

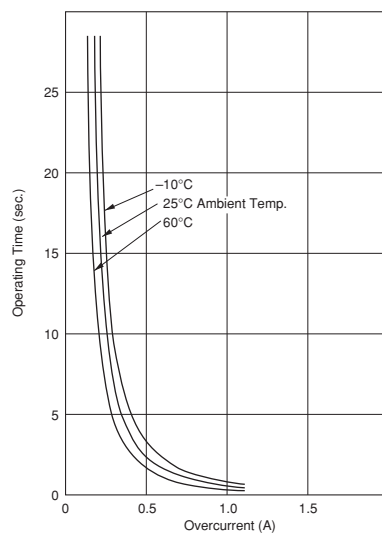

Continued on the following page. ☐

Continued from the preceding page.

Operating Time 265V Series (Typical Curve)

PTGL09AR390M9C61B0



PTGL09AR250H8B52B0



PTGL12AR270M9C01B0



PTGL12AR150H8B72B0



PTGL14AR180M9C01B0



PTGL13AR100H8B72B0



Continued on the following page. ↗

9

☐ Continued from the preceding page.

■ Operating Time 265V Series (Typical Curve)

PTGL18AR6R0H8B72B0



■ Application Circuit

(1) Transistor Protection Circuit



(2) Transformer Protection Circuit 1

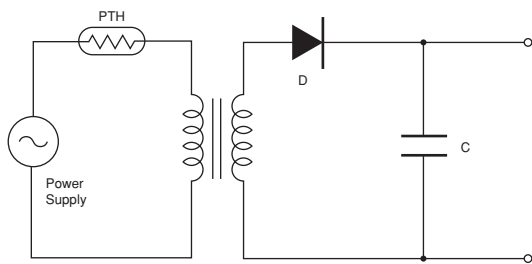

(3) Transformer Protection Circuit 2

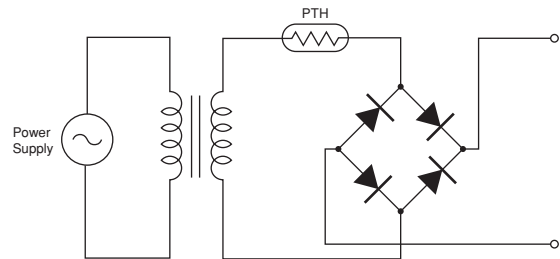

(4) Fluorescent Lamp Protection Circuit



(5) Telecommunication Circuit



PTGL Series Narrow Current Band Specifications and Test Methods

No.	Item	Rating Value	Method of Examination						
1	Operating Temperature	-30 to +85°C	The temperature range with maximum voltage applied to the POSISTOR®.						
2	Storage Temperature	-40 to +125°C	The temperature range with zero voltage.						
3	Resistance Value (at 25°C)	Satisfies ratings	Resistance value is measured by applying voltage under 1.0Vdc (by a direct current of less than 10mA) at 25°C. But it must be measured after maximum voltage is applied for 180 seconds and then is left for 2 hours at 25°C.						
4	Withstanding Voltage	No problem	We apply AC voltage 120% that of the maximum voltage to POSISTOR® by raising voltage gradually for 180±5 seconds at 25°C. (A protective resistor is to be connected in series, and the inrush current through POSISTOR® must be limited below maximum rated value.)						
5	Protective Threshold Current	Satisfies ratings (Trip Current, Hold Current)	Maximum current is measured in this examination. Voltage is applied to POSISTOR® for 3 minutes step by step on still air based on "Protective Threshold Current Test Conditions" shown in next page. Stable current is measured at each step.						
6	Tensile Strength of Lead Wire Terminal	No damage	The load is gradually applied to each terminal of POSISTOR® until the force of the following table in the axial direction with fixing POSISTOR®'s body itself and this load is kept for 10 seconds. <table border="1" style="margin: 10px auto; border-collapse: collapse;"> <thead> <tr> <th style="width: 50%;">Lead Diameter</th> <th style="width: 50%;">Force</th> </tr> </thead> <tbody> <tr> <td>ø0.60mm max.</td> <td>4.90N</td> </tr> <tr> <td>ø0.65mm min.</td> <td>9.80N</td> </tr> </tbody> </table>	Lead Diameter	Force	ø0.60mm max.	4.90N	ø0.65mm min.	9.80N
Lead Diameter	Force								
ø0.60mm max.	4.90N								
ø0.65mm min.	9.80N								
7	Bending Strength of Lead Wire Terminal	Lead wire does not come off	POSISTOR® is held so that it is perpendicular to the lead wire with the following lead hanging in the axial direction of the lead wire. The lead wire is slowly bent to 90° and returned. Then it is slowly bent in the opposite direction and returned to original state. <table border="1" style="margin: 10px auto; border-collapse: collapse;"> <thead> <tr> <th style="width: 50%;">Lead Diameter</th> <th style="width: 50%;">Force</th> </tr> </thead> <tbody> <tr> <td>ø0.60mm max.</td> <td>2.45N</td> </tr> <tr> <td>ø0.65mm min.</td> <td>4.90N</td> </tr> </tbody> </table>	Lead Diameter	Force	ø0.60mm max.	2.45N	ø0.65mm min.	4.90N
Lead Diameter	Force								
ø0.60mm max.	2.45N								
ø0.65mm min.	4.90N								
8	Solderability	Solder is applied around the lead wire covering 3/4 or more of the circumference without gap in the axial direction.	The Lead wire of POSISTOR® is soaked in an Isopropyl Alcohol (JIS K 8839) solution (about 25wt%) of colophony (JIS K 5902) for 5-10 sec. Each lead wire is soaked in molten solder (JIS Z 3282 H60A) at 235±5°C from the bottom to a point of 2.0-2.5mm for 2±0.5 seconds.						
9	Terminal Durability of Soldering	$\Delta R/R25 \leq \pm 15\%$	The lead wire of POSISTOR® is soaked in molten solder (JIS Z 3282 H60A) at 350±10°C from the bottom to a point of 2.0-2.5mm for 3.5±0.5 seconds. After the device is left at room temperature (25°C) for 24±4 hours, the resistance is then measured.						
10	Humidity Test	$\Delta R/R25 \leq \pm 20\%$	POSISTOR® is set in an environmental chamber at 60±2°C and 90-95% humidity for 500±4 hours. After the device is left at room temperature (25°C) for one hour, the resistance measurement is then performed.						
11	Load Test at High Temperature	$\Delta R/R25 \leq \pm 20\%$	POSISTOR® is set in an environmental chamber at 85±3°C with maximum voltage applied for 500±4 hours. After the device is left at room temperature (25°C) for one hour, the resistance measurement is performed. (A protective resistor is to be connected in series and the inrush current through POSISTOR® must be limited below maximum rated value.)						
12	Load Cycle Test at Room Temperature	$\Delta R/R25 \leq \pm 20\%$	POSISTOR® is set at room temperature (25±2°C) with maximum voltage applied for 1 minute and then is left without voltage applied for 5 minutes. This cycle is repeated for 100 cycles, and after the device is left at room temperature (25°C) for one hour, the resistance measurement is performed. (A protective resistor is to be connected in series and the inrush current through POSISTOR® must be limited below maximum rated value.)						

Continued on the following page.

PTGL Series Narrow Current Band Specifications and Test Methods

☐ Continued from the preceding page.

■ Protective Threshold Current Test Conditions

1. Substrate

Materials: Phenol

Size: 50x50x1.6mm

Land Pattern: Cu land without through hole



2. Measurement condition

Solder POSISTOR[®] on the substrate, then put a 150mm³ cover surrounding POSISTOR[®] to prevent airflow.

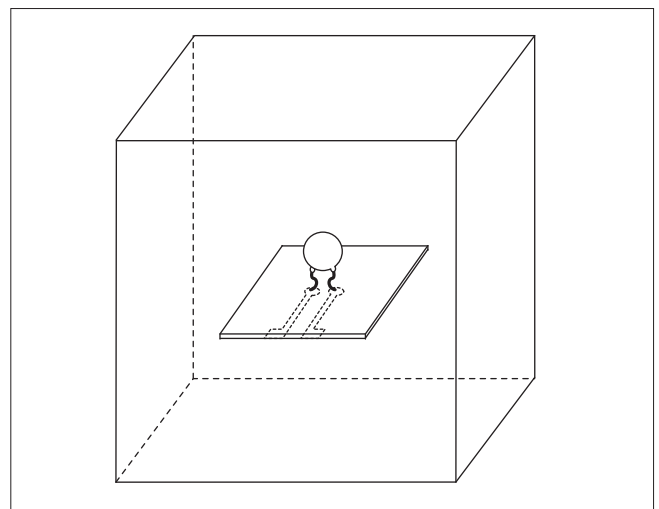

3. Measurement circuit

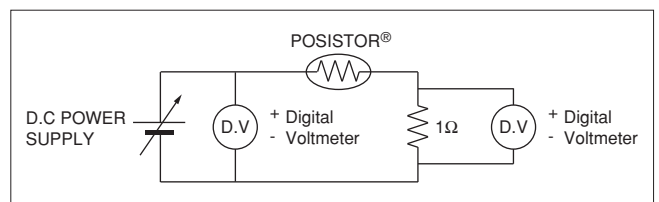

PTGL Series Specifications and Test Methods

Item	Rating Value	Method of Examination						
Continuous Operating Temperature	-10 to +60 °C	The temperature range with maximum voltage applied to the POSISTOR®.						
Resistance Value (at 25°C)	Satisfies ratings	Resistance value is measured by applying voltage under 1.5Vdc (by a direct current of less than 10mA) at 25°C. But it must be measured after maximum voltage is applied for 180 seconds and then is left for 2 hours at 25°C. As for 16V series, measurement probes should be connected on the lead wire at the point within 2mm from the below side of the forming. Resistance should be measured by 4 wiring method.						
Withstanding Voltage	No problem	We apply AC voltage 120% (16V Series: 110%) that of the maximum voltage to POSISTOR® by raising voltage gradually for 180±5 seconds at 25°C. (A protective resistor is to be connected in series, and the inrush current through POSISTOR® must be limited below max. rated value.)						
Tensile Strength of Lead Wire Terminal	No damage	The load is gradually applied to each terminal of POSISTOR® until the force of the following table in the axial direction with fixing POSISTOR®'s body itself and this load is being kept for 10 seconds. <table border="1" style="margin-left: auto; margin-right: auto;"> <thead> <tr> <th>Lead Diameter</th> <th>Force</th> </tr> </thead> <tbody> <tr> <td>ø0.60mm max.</td> <td>4.90N</td> </tr> <tr> <td>ø0.65mm min.</td> <td>9.80N</td> </tr> </tbody> </table>	Lead Diameter	Force	ø0.60mm max.	4.90N	ø0.65mm min.	9.80N
Lead Diameter	Force							
ø0.60mm max.	4.90N							
ø0.65mm min.	9.80N							
Bending Strength of Lead Wire Terminal	Lead wire does not come off.	POSISTOR® is held so that it is perpendicular to the lead wire with the following lead hanging in the axial direction of the lead wire. The lead wire is slowly bent to 90° and returned. Then it is slowly bent in the opposite direction and returned to original state. <table border="1" style="margin-left: auto; margin-right: auto;"> <thead> <tr> <th>Lead Diameter</th> <th>Force</th> </tr> </thead> <tbody> <tr> <td>ø0.60mm max.</td> <td>2.45N</td> </tr> <tr> <td>ø0.65mm min.</td> <td>4.90N</td> </tr> </tbody> </table>	Lead Diameter	Force	ø0.60mm max.	2.45N	ø0.65mm min.	4.90N
Lead Diameter	Force							
ø0.60mm max.	2.45N							
ø0.65mm min.	4.90N							
Solderability	Solder is applied around the lead wire covering 3/4 or more of the circumference without gap in the axial direction.	The Lead wire of POSISTOR® is soaked in an Isopropyl alcohol (JIS K 8839) or ethanol (JIS K 8101) solution (about 25wt%) of colophony (JIS K 5902) for 5 to 10 sec. And, each lead wire is soaked in molten solder (JIS Z 3282 H60A) at 235±5°C from the bottom to a point of 2.0 to 2.5mm for 2±0.5 sec.						
Terminal Durability of Soldering	$\Delta R/R_{25} \leq \pm 15\%$	The lead wire of POSISTOR® is soaked in molten solder (JIS Z 3282 H60A) at 350±10°C from the bottom to a point of 2.0 to 2.5mm for 3.5±0.5 sec. After the device is being left at room temperature (25°C) for 24±4 hours, the resistance is measured.						
Humidity Test	$\Delta R/R_{25} \leq \pm 20\%$	POSISTOR® is set in an environmental chamber at 40±2°C and 90 to 95% humidity for 500±4 hours. After the device is left at room temperature (25°C) for one hour, the resistance measurement is performed.						
Load Cycle Test at High Temperature	$\Delta R/R_{25} \leq \pm 20\%$	POSISTOR® is set in an environmental chamber at 60±3°C with maximum voltage applied for 1.5 hours and then is left without voltage applied for 0.5 hours. This cycle is repeated for 1000±10 hours, and after the device is left at room temperature (25°C) for one hour, the resistance measurement is performed. (A protective resistor is to be connected in series and the inrush current through POSISTOR® must be limited below max. rated value.)						

POSISTOR® for Circuit Protection



Inrush Current Suppression (Less than 100µF)

POSISTOR® is one of lead type PTC Thermistor that is able to support overcurrent or inrush current issue on the power supply circuit.

It is able to integrated circuit for protection from inrush current suppression with POSISTOR® and relay or semiconductor switch as thyristor.

■ Features

1. Protection against overcurrent situations
2. Automatic reset from protective trip mode
3. Space-saving
4. Various characteristics to meet a suitable resistance value

■ Applications

POSISTOR® is an integrated solution to work as both current limit resistor and overcurrent fuse. It works as a stable resistor in normal operation and products itself against overcurrent situation.

It can be replaced from normal resistor or the resistor with temperature fuses solution as Fig.1.



Fig.1

POSISTOR® works as normal resistor in normal condition, and it works as protector against over current situation on the circuit.

1. High-power switching power supply (LCD TV)
2. The power supply for inverter on outside unit for Air-conditioner
3. The power supply for inverter type fluorescent lamp
4. Other SW type power supply

Part Number	Max. Voltage (V)	Resistance (at +25°C) (ohm)	Max. Inrush Current (A)	Max. Applying Time of Inrush (ms)	Body Diameter (D) (mm)	Thickness (T) (mm)	Lead Space (F) (mm)	Lead Diameter (phi d) (mm)
PTGL07AS121M0N51B0	280	120 ±20%	8.46 peak	10	7.8	6.0	5.0	0.5
PTGL07AS181M0N51B0	280	180 ±20%	6.22 peak	10	7.8	6.0	5.0	0.5
PTGL07AS201M0N51B0	280	200 ±20%	5.66 peak	10	7.8	6.0	5.0	0.5

Max. inrush current shows the maximum inrush current value which be introduced into "POSISTOR" at operating temperature range.

Max. applying time of inrush shows the maximum applying time of inrush current value at operating temperature range.

Operating temperature range is -40 to +105°C.

Taping type of part numbers with "A0" is available.



(in mm)

POSISTOR® for Circuit Protection



Inrush Current Suppression for High Capacitance (100µF or more)

POSISTOR® is one of lead type PTC Thermistor that is able to support overcurrent or inrush current issue on the power supply circuit.

It is able to integrated circuit for protection from inrush current suppression with POSISTOR® and relay or semiconductor switch as thyristor.

■ Features

1. Protection against overcurrent situations
2. Automatic reset from protective trip mode
3. Space-saving
4. Various characteristics to meet a suitable resistance value

■ Applications

POSISTOR® is an integrated solution to work as both current limit resistor and overcurrent fuse. It works as a stable resistor in normal operation and products itself against overcurrent situation.

It can be replaced from normal resistor or the resistor with temperature fuses solution as Fig.1.



Fig.1

POSISTOR® works as normal resistor in normal condition, and it works as protector against over current situation on the circuit.

1. High-power switching power supply (LCD TV)
2. The power supply for inverter on outside unit for Air-conditioner
3. The power supply for inverter type fluorescent lamp
4. Other SW type power supply

Part Number	Max. Voltage (V)	Resistance (at +25°C) (ohm)	Max. Inrush Current (A)	Max. Charge Energy (at +60°C) (J)	Max. Charge Energy (at +85°C) (J)	Body Diameter (D) (mm)	Thickness (T) (mm)	Lead Space (F) (mm)	Lead Diameter (phi d) (mm)
PTGL14AS470H0B02BZ	280	47 ±25%	27 peak	106.9	56.9	16.0	6.5	10.0	0.6
PTGL16AS330H0B02BZ	280	33 ±25%	39 peak	130.8	80.8	18.0	6.5	10.0	0.6
PTGL16AS470H0B02BZ	280	47 ±25%	27 peak	130.8	80.8	18.0	6.5	10.0	0.6
PTGL16AS680H0B02BZ	280	68 ±25%	19 peak	130.8	80.8	18.0	6.5	10.0	0.6
PTGL16AS101H0B02BZ	280	100 ±25%	13 peak	130.8	80.8	18.0	6.5	10.0	0.6
PTGL20AS330H0D02BZ	280	33 ±25%	39 peak	181.7	131.7	22.0	6.5	10.0	0.8
PTGL20AS470H0D02BZ	280	47 ±25%	27 peak	181.7	131.7	22.0	6.5	10.0	0.8

Max. inrush current shows the maximum applying time of inrush current value at operating temperature range.

Max charge energy is defined as the maximum charged up energy value of over 95%.

The capacitance is calculated as the following formula.

$$J = CV^2/2 \quad C: \text{capacitance, } V: \text{peak voltage}$$

Note: The criteria of the standard for the maximum charged up energy value of over 95%.

If there is the difference between our definition and yours, could you ask us free?

Operating temperature range is -20 to +85°C.



Inrush Current Suppression Specifications and Test Methods

Item	Rating Value	Method of Examination
Humidity Test	$\Delta R/R_{25} \leq \pm 20\%$	POSISTOR® is set in an environmental chamber at 85±3°C and 85% humidity for 500±4 hours. After the device is left at room temperature (25°C) for one hour, the resistance measurement is performed.
High Temperature Continuous Load	$\Delta R/R_{25} \leq \pm 20\%$	POSISTOR® is set in an environmental chamber at 85±3°C with maximum voltage applied for 500±4 hours. After the device is left at room temperature (25°C) for one hour, the resistance measurement is performed.
Load Cycle Test at Room Temperature	$\Delta R/R_{25} \leq \pm 20\%$	POSISTOR® is set in a room temperature (25±2°C) with maximum voltage applied for 1 minute, and then is left without voltage applied for 5 minutes. This cycle is repeated for 10k cycles, and after the device is left at room temperature (25°C) for one hour, the resistance measurement is performed.

POSISTOR[®] for Circuit Protection



Overheat Sensing Chip Tight Tolerance Type

This chip PTC Thermistor is a reflow soldering SMD type for overheat sensing for power transistors, power diodes and power ICs in hybrid circuits.

■ Features

1. SMD type is helpful for miniaturizing circuits because of its small size and light weight.
2. Excellent thermal response due to small size
3. Solid-state construction provides excellent resistance to mechanical vibration and impact resistance.
4. Contactless operation provides noiseless operation.



Part Number	Dimensions (mm)				
	L	W	T	e	g
PRF15_RC	1.0±0.05	0.5±0.05	0.5±0.05	0.15 to 0.4	0.3 min.
PRF18_RB	1.6±0.15	0.8±0.15	0.8±0.15	0.1 to 0.6	-

Chip Tight Tolerance Type 0402 (1005) Size

Part Number	Sensing Temperature (at 10k ohm) (°C)	Sensing Temperature (at 100k ohm) (°C)	Maximum Voltage (V)	Resistance (at 25°C) (k ohm)	Operating Temperature Range (°C)
PRF15AR102RB6RC	135 ±5°C	150 ±3°C	32	1 ±50%	-40 to 160
PRF15BA102RB6RC	125 ±5°C	140 ±3°C	32	1 ±50%	-40 to 150
PRF15BB102RB6RC	115 ±5°C	130 ±3°C	32	1 ±50%	-40 to 140
PRF15BC102RB6RC	105 ±5°C	120 ±3°C	32	1 ±50%	-40 to 130
PRF15BD102RB6RC	95 ±5°C	110 ±3°C	32	1 ±50%	-40 to 120
PRF15BE102RB6RC	85 ±5°C	100 ±3°C	32	1 ±50%	-40 to 110
PRF15BF102RB6RC	75 ±5°C	90 ±3°C	32	1 ±50%	-40 to 100
PRF15BG102RB6RC	65 ±5°C	80 ±3°C	32	1 ±50%	-40 to 90

This series is applied to reflow soldering.

Part Number	Sensing Temperature (at 4.7M ohm) (°C)	Maximum Voltage (V)	Resistance (at 25°C) (k ohm)	Operating Temperature Range (°C)
PRF15BB103RB6RC	130 ±3°C	32	10 ±50%	-20 to 140
PRF15BE103RB6RC	100 ±3°C	32	10 ±50%	-20 to 110
PRF15BG103RB6RC	80 ±3°C	32	10 ±50%	-20 to 90

This series is applied to reflow soldering.

Chip Tight Tolerance Type 0603 (1608) Size

Part Number	Sensing Temperature (at 4.7k ohm) (°C)	Sensing Temperature (at 47k ohm) (°C)	Maximum Voltage (V)	Resistance (at 25°C) (ohm)	Operating Temperature Range (°C)
PRF18BB471RB5RB	115 ±3°C	130 ±7°C	32	470 ±50%	-20 to 140
PRF18BC471RB5RB	105 ±3°C	120 ±7°C	32	470 ±50%	-20 to 130
PRF18BD471RB5RB	95 ±3°C	110 ±7°C	32	470 ±50%	-20 to 120
PRF18BE471RB5RB	85 ±3°C	100 ±7°C	32	470 ±50%	-20 to 110
PRF18BF471RB5RB	75 ±3°C	90 ±7°C	32	470 ±50%	-20 to 100
PRF18BG471RB5RB	65 ±3°C	80 ±7°C	32	470 ±50%	-20 to 90

This series is applied to flow/reflow soldering.

This series is recognized by UL.

POSISTOR® for Circuit Protection



Overheat Sensing Chip Type

This chip PTC Thermistor is a reflow soldering SMD type for overheat sensing for power transistors, power diodes and power ICs in hybrid circuits.

■ Features

1. SMD type is helpful for miniaturizing circuits because of its small size and light weight.
2. Excellent thermal response due to small size
3. Solid-state construction provides excellent resistance to mechanical vibration and impact resistance.
4. Contactless operation provides noiseless operation.



Part Number	Dimensions (mm)				
	L	W	T	e	g
PRF18_RB	1.6±0.15	0.8±0.15	0.8±0.15	0.1 to 0.6	-
PRF21_RA	2.0±0.2	1.25±0.2	0.9±0.2	0.2 min.	0.5 min.

Chip Type 0603 (1608) Size

Part Number	Sensing Temperature (at 4.7k ohm) (°C)	Sensing Temperature (at 47k ohm) (°C)	Maximum Voltage (V)	Resistance (at 25°C) (ohm)	Operating Temperature Range (°C)
PRF18AS471QB5RB	145 ±5°C	-	32	470 ±50%	-20 to 160
PRF18AR471QB5RB	135 ±5°C	150 ±7°C	32	470 ±50%	-20 to 160
PRF18BA471QB5RB	125 ±5°C	140 ±7°C	32	470 ±50%	-20 to 150
PRF18BB471QB5RB	115 ±5°C	130 ±7°C	32	470 ±50%	-20 to 140
PRF18BC471QB5RB	105 ±5°C	120 ±7°C	32	470 ±50%	-20 to 130
PRF18BD471QB5RB	95 ±5°C	110 ±7°C	32	470 ±50%	-20 to 120
PRF18BE471QB5RB	85 ±5°C	100 ±7°C	32	470 ±50%	-20 to 110
PRF18BF471QB5RB	75 ±5°C	90 ±7°C	32	470 ±50%	-20 to 100
PRF18BG471QB5RB	65 ±5°C	80 ±7°C	32	470 ±50%	-20 to 90

This series is applied to flow/reflow soldering.
 This series is recognized by UL.

Chip Type 0805 (2012) Size

Part Number	Sensing Temperature (at 4.7k ohm) (°C)	Maximum Voltage (V)	Resistance (at 25°C) (ohm)	Operating Temperature Range (°C)
PRF21AS471QB5RA	145 ±5°C	32	470 ±50%	-20 to 160
PRF21AR471QB5RA	135 ±5°C	32	470 ±50%	-20 to 150
PRF21BA471QB5RA	125 ±5°C	32	470 ±50%	-20 to 140
PRF21BB471QB5RA	115 ±5°C	32	470 ±50%	-20 to 130
PRF21BC471QB5RA	105 ±5°C	32	470 ±50%	-20 to 120
PRF21BD471QB5RA	95 ±5°C	32	470 ±50%	-20 to 110
PRF21BE471QB5RA	85 ±5°C	32	470 ±50%	-20 to 100

This series is applied to flow/reflow soldering.
 This series is recognized by UL.

Overheat Sensing Chip Type (Related Data)

Standard Land Pattern Dimensions



Part Number	Soldering Methods	Dimensions (mm)			
		Chip (L×W)	a	b	c
PRF15	Reflow Soldering	1.0×0.5	0.5	0.4-0.5	0.5
PRF18		1.6×0.8	0.6-0.8	0.6-0.7	0.6-0.8
PRF21		2.0×1.25	1.0-1.2	0.5-0.7	1.0-1.2

Resistance - Temperature Characteristics (Typical)



Overheat Protection Circuit

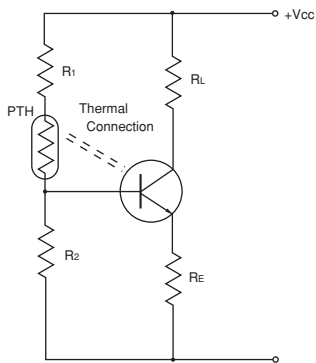

Temperature Sensing Circuit



Overheat Sensing Chip Tight Tolerance Type (Reference Data)

■ Resistance - Temperature Characteristics Range

PRF15AR102RB6RC

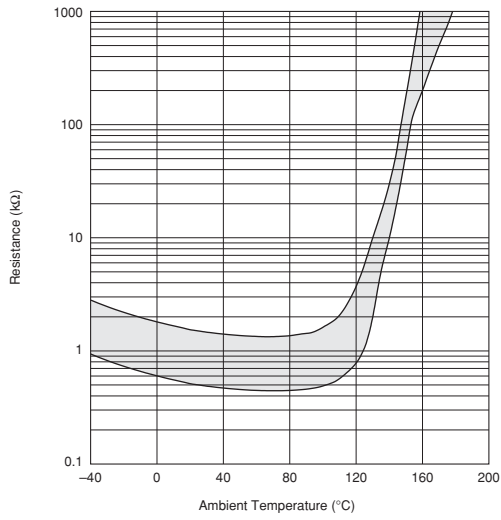

PRF15BA102RB6RC

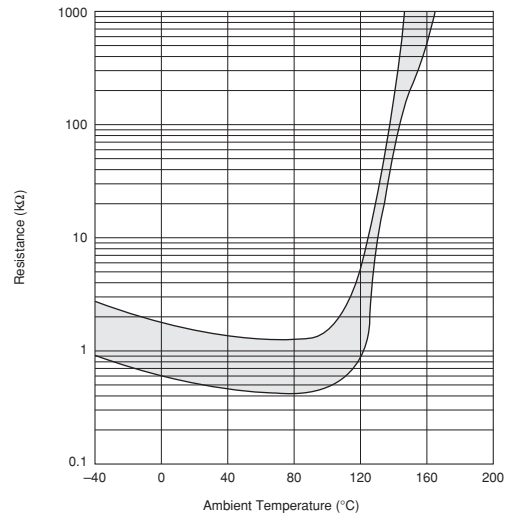

PRF15BB102RB6RC

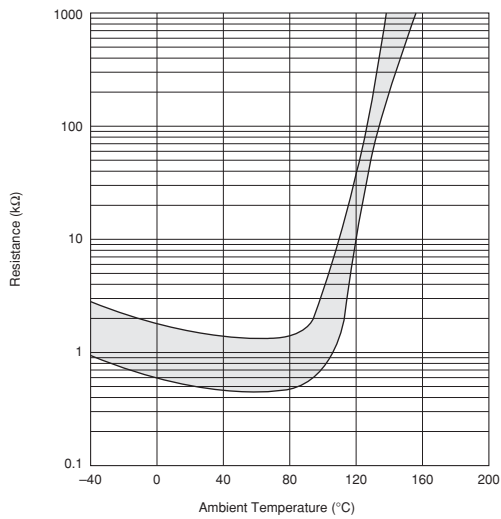

PRF15BC102RB6RC

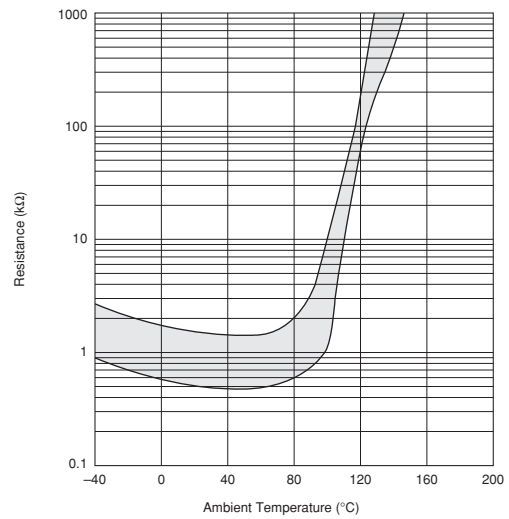

PRF15BD102RB6RC

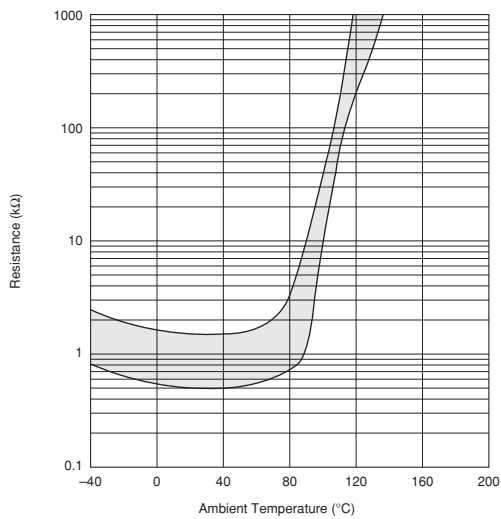

PRF15BE102RB6RC

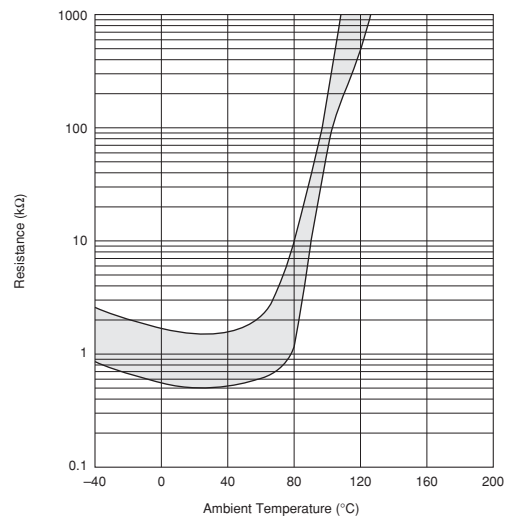

Continued on the following page. ↗

Overheat Sensing Chip Tight Tolerance Type (Reference Data)

☐ Continued from the preceding page.

■ Resistance - Temperature Characteristics Range

PRF15BF102RB6RC



PRF15BG102RB6RC



PRF15BB103RB6RC



PRF15BE103RB6RC



PRF15BG103RB6RC



PRF18BB471RB5RB



Overheat Sensing Chip Tight Tolerance Type (Reference Data)

☐ Continued from the preceding page.

■ Resistance - Temperature Characteristics Range

PRF18BC471RB5RB



PRF18BD471RB5RB



PRF18BE471RB5RB



PRF18BF471RB5RB



PRF18BG471RB5RB



Overheat Sensing Chip Type (Ref. Only)

■ Resistance - Temperature Characteristics Range

PRF18/21AS471Q Type



PRF18/21AR471Q Type



PRF18/21BA471Q Type



PRF18/21BB471Q Type



PRF18/21BC471Q Type

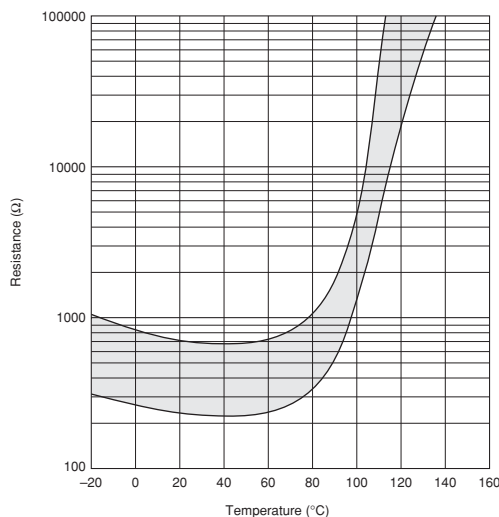

PRF18/21BD471Q Type

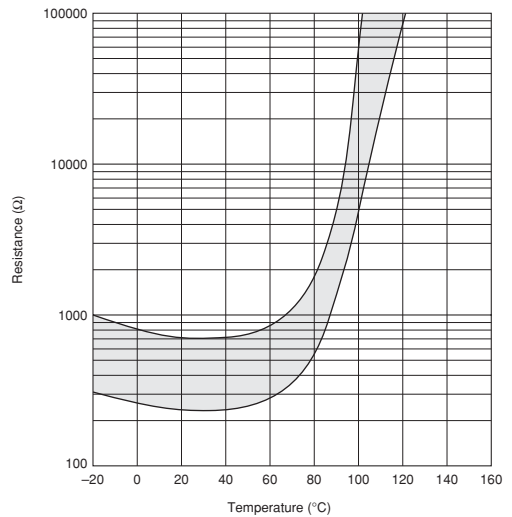

Overheat Sensing Chip Type (Ref. Only)

☐ Continued from the preceding page.

■ Resistance - Temperature Characteristics Range

PRF18/21BE471Q Type



PRF18BF471Q Type



PRF18BG471Q Type



Overheat Sensing Chip Tight Tolerance Type Specifications and Test Methods

■ PRF15_102R Series

No.	Item	Criteria	Test Conditions									
1	Resistance Value at 25°C	Within the specified range	After applying maximum operating voltage for 3 mins. and leaving for 2 hours in 25°C, measured by applying voltage less than DC1.0V.									
2	Vibration	<ul style="list-style-type: none"> Resistance (R25) change: Less than ±20% (*) Appearance: No defects or abnormalities 	Reference standard: IEC 60068-2-6 (1995) · Soldered PTC to PCB (**) · Frequency range: 10 to 55Hz · Amplitude: 1.5mm · Sweep rate: 1 octave/min. · Direction: X-Y-Z (3 direction) · 24 cycles in each axis									
3	Solderability	Wetting of soldering area: ≥95%	Reference standard: IEC 60068-2-58 (2004) · Solder: Sn-3.0Ag-0.5Cu · Solder temp.: 245±5°C · Immersion time: 3±0.3s									
4	Resistance to Soldering Heat	<ul style="list-style-type: none"> Appearance: No defects or abnormalities Resistance (R25) change: Less than ±20% (*) 	Reference standard: IEC 60068-2-58 (2004) [Solder bath method] · Solder: Sn-3.0Ag-0.5Cu · Preheat: 150±5°C, 90 to 120s · Solder temp.: 260±5°C · Immersion time: 10±1s									
5	High Temperature Storage	<ul style="list-style-type: none"> Appearance: No defects or abnormalities Resistance (R25) change: Less than ±20% (*) 	Reference standard: IEC 60068-2-2 (2007) · Soldered PTC to PCB (**) · (Max. operating temp.)±2°C · 1000+48/-0 hrs.									
6	Low Temperature Storage		Reference standard: IEC 60068-2-1 (2007) · Soldered PTC to PCB (**) · (Min. operating temp.)±3°C · 1000+48/-0 hrs									
7	Damp Heat, Steady State		Reference standard: IEC 60068-2-67 (1995) · Soldered PTC to PCB (**) · +85±2°C, 85±5%RH · 1000+48/-0 hrs									
8	Thermal Shock		Reference standard: IEC 60068-2-14 (2009) [Test Na] · Soldered PTC to PCB (**) · Transport time: <10 sec. · Test condition: See below table <table border="1" style="margin-left: 40px;"> <thead> <tr> <th>Step</th> <th>Condition</th> <th>Time</th> </tr> </thead> <tbody> <tr> <td>1</td> <td>(Min. Operating temp.)±3°C</td> <td>30min.</td> </tr> <tr> <td>2</td> <td>(Max. Operating temp.)±2°C</td> <td>30min.</td> </tr> </tbody> </table> · Test cycle: 5 cycles	Step	Condition	Time	1	(Min. Operating temp.)±3°C	30min.	2	(Max. Operating temp.)±2°C	30min.
Step	Condition		Time									
1	(Min. Operating temp.)±3°C	30min.										
2	(Max. Operating temp.)±2°C	30min.										
9	High Temperature Load	Reference standard: IEC 60068-2-2 (2007) · Soldered PTC to PCB (**) · (Max. operating temp.)±2°C · Applied max. voltage · 1000+48/-0 hrs.										

*: The resistance value after the test. It is measured by applying voltage less than DC1.0V after left at 25±2°C for 2hrs.

** : Above mentioned soldering is done under the following conditions at our side.

- Glass-Epoxy PC board
- Standard land dimension
- Standard solder paste
- Standard solder profile

Above conditions are mentioned in Notice.

Overheat Sensing Chip Tight Tolerance Type Specifications and Test Methods

■ PRF15_103R Series

No.	Item	Rating value	Method of Examination												
1	Resistance Value (at 25°C)	The resistance value should be within the specified tolerance.	After applying maximum operating voltage for 3 minutes and leaving for 2 hours at 25°C, measured by applying voltage of less than 3VDC.												
2	Vibration	There is no abnormal appearance after the test. Resistance change is less than ±20%.(*)	Soldered PTC to PCB (**) · Vibration: 10 to 55 to 10Hz (1 min.) · Max. Amplitude: 1.5mm Vibrate for 2 hours in each of 3 mutually perpendicular plane for a total of 6 hours. This test condition is according to "JIS C 60068-2-6 (1999)."												
3	Solderability	Min. 95% electrode is covered with new solder. Resistance change is less than ±20%.(*)	· Solder temp.: 230±5°C · Solder: Sn 63%/Pb 37% (or 60/40%) · Soaking time: 3±0.5 secs. · Soaking position: Until a whole electrode is soaked. This test condition is according to "JIS C 60068-2-58 (2006)."												
4	Soldering Heat Resistance	There is no abnormal appearance after the test. Resistance change is less than ±20%.(*)	· Solder temp.: 260±5°C · Solder: Sn 63%/Pb 37% (or 60/40%) · Flux: Containing less than 0.2wt% of chlorine. · Soaking time: 10±1 secs. · Soaking position: Until a whole electrode is soaked. · Preheating: 150±5°C 3 mins. This test condition is according to "JIS C 60068-2-58 (2006)."												
5	Dry Heat	There is no abnormal appearance after the test. Resistance change is less than ±20%.(*)	· Soldered PTC to PCB. (**) · +125±3°C leave for 1000+12/-0 hrs. This test condition is according to "JIS C 60068-2-2 (1995)."												
6	Cold		· Soldered PTC to PCB. (**) · -20±3°C leave for 1000+12/-0 hrs.												
7	Damp Heat		· Soldered PTC to PCB. (**) · +60±3°C, 90 to 95%RH leave for 1000+12/-0 hrs.												
8	Temperature Cycling		· Soldered PTC to PCB. (**) · Cycles: 5 cycles · Conditions: See below table												
			<table border="1" style="width: 100%; border-collapse: collapse; text-align: center;"> <thead> <tr> <th>Step</th> <th>Temp. (°C)</th> <th>Time (minute)</th> </tr> </thead> <tbody> <tr> <td>1</td> <td>-20+0, -3</td> <td>30</td> </tr> <tr> <td>2</td> <td>Room temp.</td> <td>10 to 15</td> </tr> <tr> <td>3</td> <td>+125+3, -0</td> <td>30</td> </tr> <tr> <td>4</td> <td>Room temp.</td> <td>10 to 15</td> </tr> </tbody> </table>	Step	Temp. (°C)	Time (minute)	1	-20+0, -3	30	2	Room temp.	10 to 15	3	+125+3, -0	30
Step	Temp. (°C)	Time (minute)													
1	-20+0, -3	30													
2	Room temp.	10 to 15													
3	+125+3, -0	30													
4	Room temp.	10 to 15													
9	High Temperature Load		· Soldered PTC to PCB. (**) · 85±3°C (in air), load max. operating voltage for 1000+12/-0 hrs.												

*: The resistance measurement after the test.
 It is measured by applying voltage less than 3VDC after left at 25±2°C for 2 hours.

** : Above mentioned soldering is done under the following conditions at our side.

- Glass-Epoxy PC board
- Standard land dimension
- Standard solder paste
- Standard solder profile

Above conditions are mentioned in Notice.

Overheat Sensing Chip Tight Tolerance Type Specifications and Test Methods

■ PRF18_471R Series

No.	Item	Specification	Test Condition														
1	Resistance Value (25°C)	The resistance value shall be within the specified tolerance.	After applying max. operating voltage for 3 minutes and leaving for 2 hours in 25°C, measured by applying voltage less than 1.5VDC. (by a direct current less than 10mA).														
2	Adhesive Strength	There is no sign of exfoliation on electrode.	EIAJ ET-7403 term 9 Prepare soldered PTC to PCB (**) and add the force of 5.0N in the direction as shown below. (PTC=POSISTOR®) 														
3	Vibration Resistance	Normal appearance Resistance change: not to exceed ±20% (*)	JIS C 5102 term 8.2 Soldered PTC to PCB (**) Vibration: 10-55-10Hz (1 min.) Width: 1.5mm Vibrate for 2 hours. in each of 3 mutually perpendicular plane for a total of 6 hours														
4	Solderability	Min. 95% electrode is covered with new solder. Resistance change: not to exceed ±20% (*)	JIS C 60068-2-20(1996) Solder temp.: 230±5°C Solder: Sn63%/Pb37% (or 60%/40%) Soaking time: 3±0.5 seconds Soaking position: Until a whole electrode is soaked.														
5	Soldering Heat Resistance	Resistance change: not to exceed ±20% (*)	JIS C 60068-2-20 (1996) Solder temp.: 260±5°C Solder: Sn63%/Pb37% (or 60%/40%) Flux: containing less than 0.2wt% of chlorine Soaking time: 10±0.5 seconds Soaking position: Until a whole electrode is soaked. Preheating: 150±5°C, 3 minutes														
6	Dry Heat	Normal appearance Resistance change: not to exceed ±20% (*) Sensing temperature change: not to exceed ±1°C	Soldered PTC to PCB. (**) 150±2°C leave for 1000±12 hours														
7	Cold		Soldered PTC to PCB. (**) -20±3°C leave for 1000±12 hours														
8	Temperature Cycling		JIS C 5102 term 9.3 Soldered PTC to PCB. (**) Times: 5 cycles <table border="1" data-bbox="938 1377 1321 1505"> <thead> <tr> <th>Step</th> <th>Temp. (°C)</th> <th>Time (min.)</th> </tr> </thead> <tbody> <tr> <td>1</td> <td>-20+0, -3</td> <td>30</td> </tr> <tr> <td>2</td> <td>room temp.</td> <td>10 to 15</td> </tr> <tr> <td>3</td> <td>+150+3, -0</td> <td>30</td> </tr> <tr> <td>4</td> <td>room temp.</td> <td>10 to 15</td> </tr> </tbody> </table>	Step	Temp. (°C)	Time (min.)	1	-20+0, -3	30	2	room temp.	10 to 15	3	+150+3, -0	30	4	room temp.
Step	Temp. (°C)	Time (min.)															
1	-20+0, -3	30															
2	room temp.	10 to 15															
3	+150+3, -0	30															
4	room temp.	10 to 15															
9	Damp Heat	Soldered PTC to PCB. (**) +40±2°C, 90-95%RH leave for 500±8 hours															
10	High Temperature Load	Soldered PTC to PCB. (**) 85±2°C (in air), load max. operating voltage for 1000±12 hours															

(*) The resistance measurement after the test.
 It is measured by applying voltage less than 1.5VDC.
 (by a direct current less than 10mA.) after left at 25±2°C for 2 hours.

(**) Above mentioned soldering is done under the following conditions at our side.
 • Glass-Epoxy PC board
 • Standard land dimensions
 • Recommendable solder paste
 • Recommendable solder profile
 Above conditions are mentioned in Notice.

Overheat Sensing Chip Type Specifications and Test Methods

■ PRF18/21_471Q Series

No.	Item	Specification	Test Condition														
1	Resistance Value (25°C)	The resistance value shall be within the specified tolerance.	After applying max. operating voltage for 3 minutes and leaving for 2 hours in 25°C, measured by applying voltage less than 1.5VDC. (by a direct current less than 10mA).														
2	Adhesive Strength	There is no sign of exfoliation on electrode.	EIAJ ET-7403 term 9 Prepare soldered PTC to PCB (**) and add the force of 5.0N in the direction as shown below. (PTC=POSISTOR®) <div style="text-align: center; margin-top: 10px;"> </div>														
3	Vibration Resistance	Normal appearance Resistance change: not to exceed ±20% (*)	JIS C 5102 term 8.2 Soldered PTC to PCB (**) Vibration: 10-55-10Hz (1 min.) Width: 1.5mm Vibrate for 2 hours. in each of 3 mutually perpendicular plane for a total of 6 hours														
4	Solderability	Min. 95% electrode is covered with new solder. Resistance change: not to exceed ±20% (*)	JIS C 60068-2-20(1996) Solder temp.: 230±5°C Solder: Sn63%/Pb37% (or 60%/40%) Soaking time: 3±0.5 seconds Soaking position: Until a whole electrode is soaked.														
5	Soldering Heat Resistance	Resistance change: not to exceed ±20% (*)	JIS C 60068-2-20 (1996) Solder temp.: 260±5°C Solder: Sn63%/Pb37% (or 60%/40%) Flux: containing less than 0.2wt% of chlorine Soaking time: 10±0.5 seconds Soaking position: Until a whole electrode is soaked. Preheating: 150±5°C, 3 minutes														
6	Dry Heat	Normal appearance Resistance change: not to exceed ±20% (*)	Soldered PTC to PCB. (**) 150±2°C leave for 1000±12 hours														
7	Cold		Soldered PTC to PCB. (**) -20±3°C leave for 1000±12 hours														
8	Temperature Cycling		JIS C 5102 term 9.3 Soldered PTC to PCB. (**) Times: 5 cycles <table border="1" style="margin: 10px auto; border-collapse: collapse; text-align: center;"> <thead> <tr style="background-color: #f2f2f2;"> <th>Step</th> <th>Temp. (°C)</th> <th>Time (min.)</th> </tr> </thead> <tbody> <tr> <td>1</td> <td>-20+0, -3</td> <td>30</td> </tr> <tr> <td>2</td> <td>room temp.</td> <td>10 to 15</td> </tr> <tr> <td>3</td> <td>+150+3, -0</td> <td>30</td> </tr> <tr> <td>4</td> <td>room temp.</td> <td>10 to 15</td> </tr> </tbody> </table>	Step	Temp. (°C)	Time (min.)	1	-20+0, -3	30	2	room temp.	10 to 15	3	+150+3, -0	30	4	room temp.
Step	Temp. (°C)	Time (min.)															
1	-20+0, -3	30															
2	room temp.	10 to 15															
3	+150+3, -0	30															
4	room temp.	10 to 15															
9	Damp Heat	Soldered PTC to PCB. (**) +40±2°C, 90-95%RH leave for 500±8 hours															
10	High Temperature Load	Soldered PTC to PCB. (**) 85±2°C (in air), load max. operating voltage for 1000±12 hours															

(*) The resistance measurement after the test.
 It is measured by applying voltage less than 1.5VDC.
 (by a direct current less than 10mA.) after left at 25±2°C for 2 hours.

(**) Above mentioned soldering is done under the following conditions at our side.
 • Glass-Epoxy PC board
 • Standard land dimensions
 • Recommendable solder paste
 • Recommendable solder profile
 Above conditions are mentioned in Notice.

POSISTOR® for Circuit Protection



Overheat Sensing Lead Type

PTFM Series has been developed for protecting power transistors, stereo main amplifiers, etc. from overheating, and also for sensing the temperature of other components which may be overheated. The "POSISTOR" offers an excellent temperature sensing ability, exhibiting a steep change in electrical resistivity near the temperature setting. PTFL Series is suitable for use as an air temperature sensor.

■ Features

1. PTFM Series is a screw-fixing type and PTFL Series is a lead type, providing ease of mounting.
2. Compact and light design as well as excellent thermal response.
3. Solid-state construction withstands mechanical vibration and impact sufficiently.
4. Contactless operation provides a prolonged service life, yet permits noiseless operation.
5. The operating point of "POSISTOR" is set on the steepest point along the resistance-temperature characteristic curve, thus performing the overheat protective operation securely.
6. PTFM Series and PTFL Series have the same temperature characteristic, providing a selection depending on the mounting method.

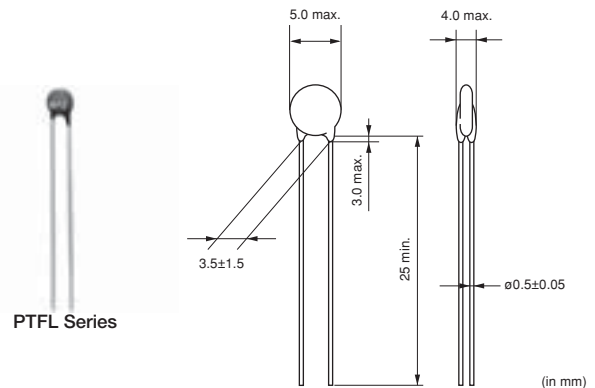

Part Number	Max. Voltage (V)	Sensing Temp. (TS) (°C)	Resistance Value at 25°C (max.) (ohm)	Resistance Value (TS-10°C) (max.) (ohm)	Resistance Value (TS°C) (min.) (ohm)
PTF□4BH471Q2N34B0	16	60	100	330	470
PTF□4BG471Q2N34B0	16	70	100	330	470
PTF□4BF471Q2N34B0	16	80	100	330	470
PTF□4BE471Q2N34B0	16	90	100	330	470
PTF□4BD471Q2N34B0	16	100	100	330	470
PTF□4BC471Q2N34B0	16	110	100	330	470
PTF□4BB471Q2N34B0	16	120	100	330	470
PTF□4BH222Q2N34B0	16	60	330	1.5k	2.2k
PTF□4BG222Q2N34B0	16	70	330	1.5k	2.2k
PTF□4BF222Q2N34B0	16	80	330	1.5k	2.2k
PTF□4BE222Q2N34B0	16	90	330	1.5k	2.2k
PTF□4BD222Q2N34B0	16	100	330	1.5k	2.2k
PTF□4BC222Q2N34B0	16	110	330	1.5k	2.2k
PTF□4BB222Q2N34B0	16	120	330	1.5k	2.2k

A blank is filled with type codes. (L: Lead type, M: with Lug-terminal)
 Operating temperature range is -10 to TS+10°C.
 Please contact us for UL recognized products.

■ Resistance - Temperature Characteristics



■ Example of Thermal Response Time Operating Time of POSISTOR®

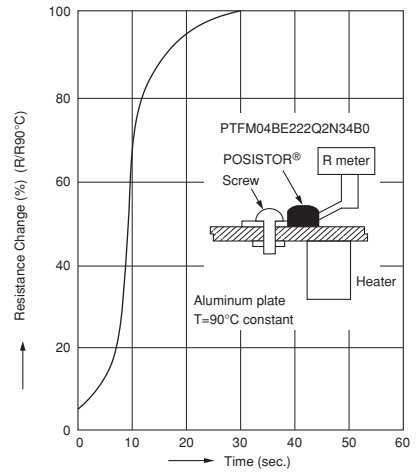

Relation between resistance change and time after POSISTOR® PTFM04BE222Q2N34B0 is installed on the part heated at a constant temperature of 90°C (3mm thick alumin sheet) is shown in the figure above.

■ Overheat Protection Circuit

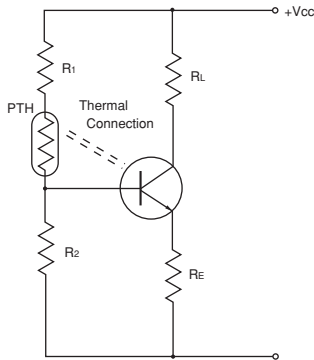

■ Overheat Sensing Circuit

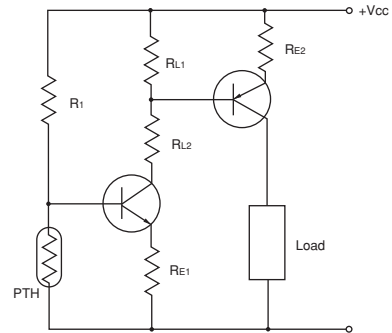

■ Resistance - Temperature Characteristics Range (Ref. Only)

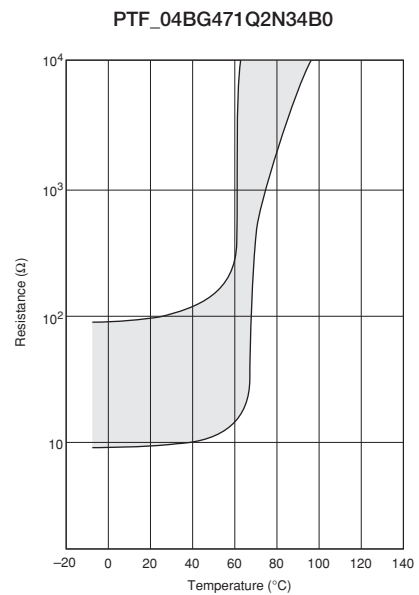
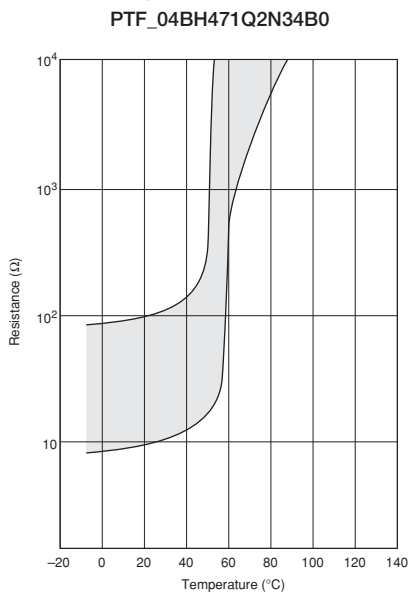

Continued on the following page. ↗

☞ Continued from the preceding page.

■ Resistance - Temperature Characteristics Range (Ref. Only)

PTF_04BF471Q2N34B0



PTF_04BE471Q2N34B0



PTF_04BD471Q2N34B0



PTF_04BC471Q2N34B0

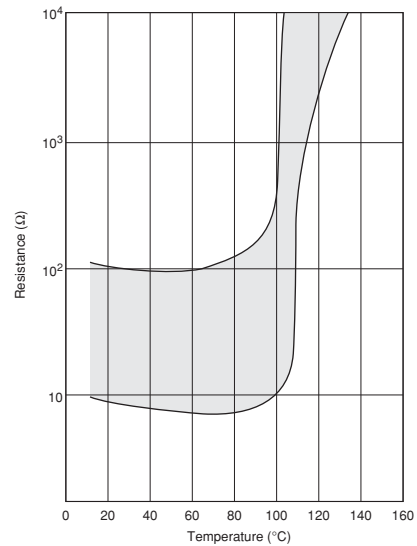

PTF_04BB471Q2N34B0

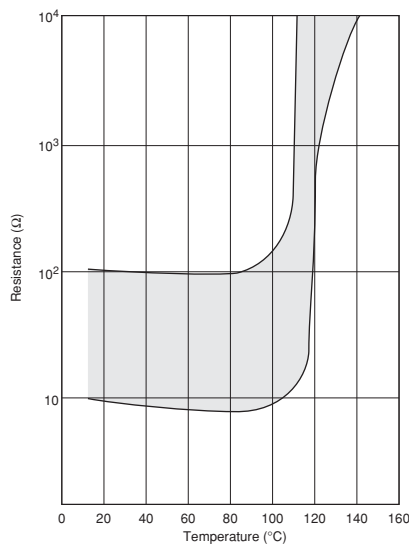

PTF_04BH222Q2N34B0

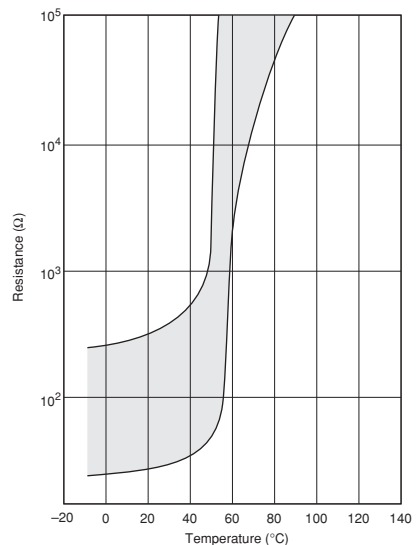

Continued on the following page. ☞

☐ Continued from the preceding page.

■ Resistance - Temperature Characteristics Range (Ref. Only)

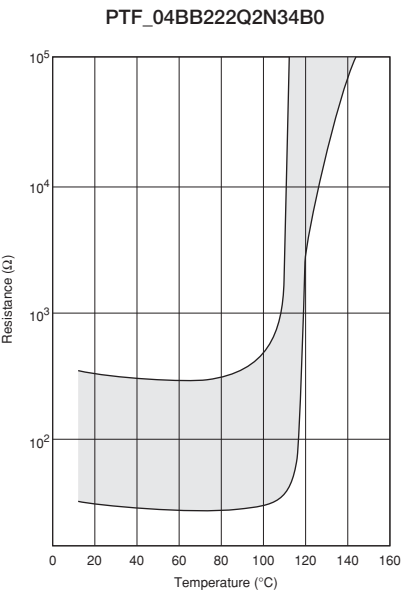
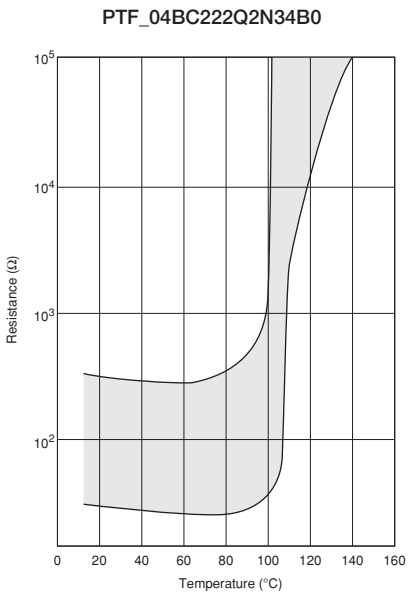
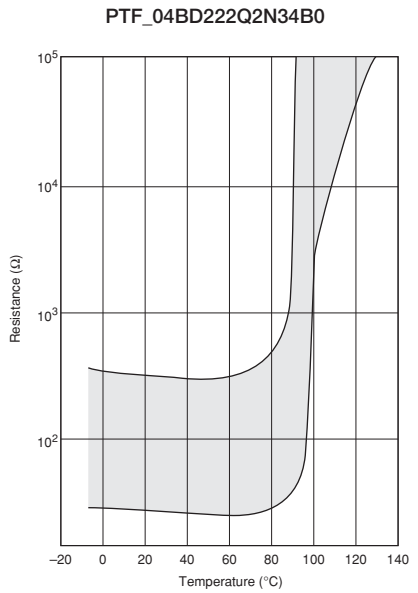
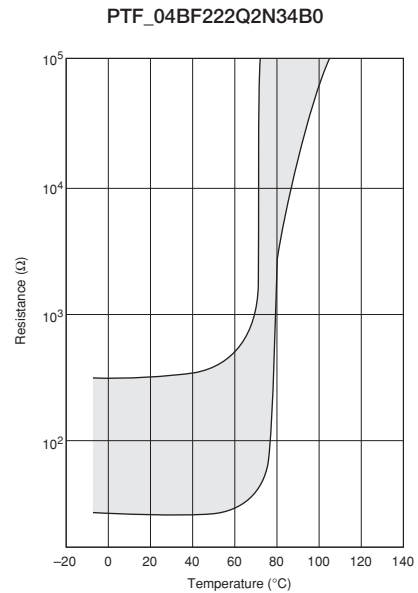

Temperature Sensor Lead Type Specifications and Test Methods

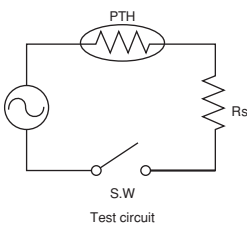
No.	Item	Rating Value	Method of Examination						
1	Resistance Value	Satisfies specification	Resistance value is measured by applying voltage under 1.5Vdc (by a direct current of less than 10mA) in a silicone oil vessel.						
2	Withstanding Voltage	No problem	We apply AC voltage 120% that of the maximum voltage to POSISTOR® by raising voltage gradually for 180±5 seconds at 25°C. (A protective resistor is to be connected in series, and the inrush current through POSISTOR® must be limited below max. rated value.)						
3	Tensile Strength of Lead Wire Terminal	No damage	The load is gradually applied to each terminal of POSISTOR® until 4.90N in the axial-direction with fixing POSISTOR®'s body itself and this load is kept for 10 seconds.						
4	Bending Strength of Lead Wire Terminal	Lead wire does not come off.	<p>POSISTOR® is held so that it is perpendicular to the lead wire with the following load hanging in the axial direction of the lead wire. The lead wire is slowly bent to 90° and returned; then it is slowly bent in the opposite direction and returned to original state. (Above mentioned procedure is done slowly with one cycle.)</p> <table border="1" style="margin-left: auto; margin-right: auto;"> <thead> <tr> <th>Series</th> <th>Force</th> </tr> </thead> <tbody> <tr> <td>PTFL</td> <td>2.45N</td> </tr> <tr> <td>PTFM</td> <td>4.90N</td> </tr> </tbody> </table>	Series	Force	PTFL	2.45N	PTFM	4.90N
Series	Force								
PTFL	2.45N								
PTFM	4.90N								
5	Solderability	Solder is applied around the lead wire covering 3/4 or more of the circumference without gap in the axial-direction.	The lead wire of POSISTOR® is soaked in a Isopropyl Alcohol (JIS K 8839) or ethanol (JIS K 8101) solution (about 25wt%) of colophony (JIS K 5902) for 5-10 sec. And, each lead wire is soaked in molten solder (JIS Z 3282 H60A) at 235±5°C from the bottom to a point of 2.0-2.5mm for 2±0.5 seconds.						
6	Terminal Durability of Soldering	$\Delta R/R_{25} \leq \pm 15\%$	The lead wire of POSISTOR® is soaked in molten solder (JIS Z 3282 H60A) at 350±10°C from the bottom to a point of 2.0-2.5 mm for 3.5±0.5 seconds. And, after the device is left at room temperature (25°C) for 24±4 hours, the resistance is measured.						
7	Damp Heat	$\Delta R/R_{25} \leq \pm 20\%$	POSISTOR® is set in an environmental chamber at 40±2°C and 90-95% humidity for 500±4 hours. And after the device is left at room temperature (25°C) for one hour, the resistance measurement is performed.						
8	High Temperature Load	$\Delta R/R_{25} \leq \pm 20\%$  <p style="text-align: center;">Test circuit</p>	<p>POSISTOR® is set in an environmental chamber at 85±3°C with maximum voltage applied for 1.5 hours and then is left without voltage applied for 0.5 hours. This cycle is repeated for 1000±10 hours, and after the device is left at room temperature (25°C) for one hour, the resistance measurement is performed. (A protective resistor is to be connected in series and the inrush current through POSISTOR® must be limited below max. rated value.)</p>						

⚠Caution/Notice

■ ⚠Caution (Storage and Operating Condition)

This product is designed for application in an ordinary environment (normal room temperature, humidity and atmospheric pressure). Do not use under the following conditions because all of these factors can deteriorate the characteristics or cause product failure and burn-out.

1. Corrosive gas or deoxidizing gas (Chlorine gas, Hydrogen sulfide gas, Ammonia gas, Sulfuric acid gas, Nitric oxide gas, etc.)
2. Volatile or flammable gas
3. Dusty conditions
4. Under vacuum, or under high or low pressure
5. Wet or humid conditions
6. Places with salt water, oils, chemical liquids or organic solvents
7. Strong vibrations
8. Other places where similar hazardous conditions exist

■ ⚠Caution (Other)

Be sure to provide an appropriate fail-safe function on your product to prevent secondary damage that may be caused by the abnormal function or the failure of our product.

■ Notice (Storage and Operating Condition)

To keep solderability of product from declining, the following storage conditions are recommended.

1. Storage condition:
 - Temperature -10 to +40 degrees C
 - Humidity less than 75%RH (not dewing condition)
2. Storage term:
 - Use this product within 6 months after delivery by first-in and first-out stocking system.
3. Handling after unpacking:
 - After unpacking, promptly reseal this product or store it in a sealed container with a drying agent.
4. Storage place:
 - Do not store this product in corrosive gas (Sulfuric acid, Chlorine, etc.) or in direct sunlight.

■ Notice (Soldering and Mounting)

PTGL Series

When the lead of this product is soldered, observe the following points to avoid the decline of element characteristics or break-down of the element.

1. Use rosin type flux or non-activated flux
2. Do not dip the body into flux (flux should be coated to lead wire only for soldering).
3. Be sure that preheating does not melt the soldering of this product.

■ Notice (Soldering and Mounting)

PTFL/PTFM Series

1. PTFM Series is to be screwed beside the Power-Transistor on the radiative plate.
2. If PTFL Series is to be mounted with thermal cement, the cement should not be of the Cyano Acrylate family.
3. Please bend the lead wire far from the root of the body and do not apply force to the lead wire of the product.
4. When the lead of this product is soldered, observe the following points to avoid the decline of element characteristics or break-down of the element.
 - (1) Use rosin type flux or non-activated flux.
 - (2) Do not dip the body into flux.
 - (Flux should be coated to lead wire only for soldering.)
 - (3) Be sure that preheating does not melt the soldering of this product.

⚠️ Caution/Notice

■ Notice (Soldering and Mounting) PRG Series

1. Solder and Flux

(1) Solder Paste

Use solder paste Sn:Pb=63:37wt%.
 For your reference, we are using
 63Sn/37Pb RMA9086 90-3-M18,
 manufactured by Alpha Metals Japan Ltd.
 96.5Sn/3.0Ag/0.5Cu M705-GRN360-K2-V,
 manufactured by Senju Metal Industry Co., LTD for any
 internal tests of this product.

(2) Flux

Use rosin type flux in the soldering process.
 If the flux below is used, some problems might be
 caused in the product characteristics and reliability.
 Please do not use these types of flux.
 • Strong acidic flux (with halide content exceeding
 0.2wt%).
 • Water-soluble flux
 (*Water-soluble flux can be defined as non-rosin type
 flux including wash-type flux and non-wash-type flux.)

2. Cleaning Conditions

To remove the flux after soldering, observe the following
 points in order to avoid deterioration of the characteristics
 or any change to the external electrodes' quality.

Solvent	Dipping Cleaning	Ultrasonic Cleaning	Drying
2-propanol	Less than 5 minutes at room temp. or Less than 2 minutes at 40°C max.	Less than 1 minute 20W/L Frequency of several 10kHz to 100kHz.	After cleaning, promptly dry this product.

A sufficient cleaning should be applied to remove flux completely.

3. Soldering Conditions

In your mounting process, observe the following points in
 order to avoid deterioration of the characteristics or
 destruction of this product. The mounting quality of this
 product may also be affected by the mounting conditions,
 shown in the points below.

This product is for reflow soldering only. Flow soldering
 should not be allowed.

(1) Printing Conditions of Solder Paste

- (a) Standard thickness of solder paste printing should
 be from 0.15 to 0.20 mm.
- (b) After soldering, the solder fillet should be a height
 from 0.2 mm to the thickness of this product (see the
 figure at right).
- (c) Too much solder result in excessive mechanical
 stress to this product. Such stress may cause
 cracking or other mechanical damage. Also, it can
 destroy the electrical performance of this product.

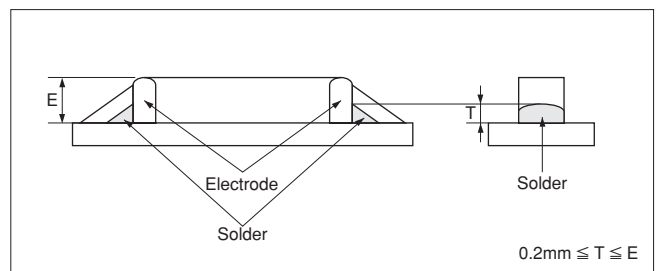

Continued on the following page.

⚠Caution/Notice

☐ Continued from the preceding page.

(2) Allowable Soldering Temperature and Time

- (a) Solder within the temperature and time combinations, indicated by the slanted lines in the graphs at right.
- (b) Excessive soldering conditions may cause dissolution of metallization or deterioration of solder-wetting on the external electrode.
- (c) In the case of repeated soldering, the accumulated soldering time should be within the range shown at right. (For example, Reflow peak temperature: 260°C, twice → The accumulated soldering time at 260°C is within 15sec.)



(3) Standard Temperature Profile for Soldering

- (a) Insufficient preheating may cause a crack on the ceramic body. The difference between preheating temperature and maximum temperature in the profile should be 100°C.
- (b) Rapid cooling by dipping in solvent or by other means is not recommended.



- (4) There may be a risk of unexpected failures (tombstone, insufficient solder-wetting, etc.) in the mounting process, caused by the mounting conditions. Please make sure that this product is correctly mounted under the specified mounting conditions.

⚠ Caution/Notice

■ Notice (Soldering and Mounting) PRF15_102R Series

1. Solder and Flux

(1) Solder Paste

Use solder paste Sn:Pb=63:37wt%.
 For your reference, we are using
 63Sn/37Pb RMA9086 90-3-M18,
 manufactured by Alpha Metals Japan Ltd.
 96.5Sn/3.0Ag/0.5Cu M705-GRN360-K2-V,
 manufactured by Senju Metal Industry Co., LTD for any
 Internal tests of this product.

(2) Flux

Use rosin type flux in soldering process.
 If below flux is used, some problems might be caused
 in the product characteristics and reliability.
 Please do not use below flux.

- Strong acidic flux (with halide content exceeding 0.2wt%).
- Water-soluble flux
 (*Water-soluble flux can be defined as non rosin type flux including wash-type flux and non-wash-type flux.)

2. Cleaning Conditions and Drying

To remove the flux after soldering, observe the following points in order to avoid deterioration of the characteristics or any change to the external electrodes quality.

(1) Cleaning Conditions

Solvent	Dipping Cleaning	Ultrasonic Cleaning
2-propanol	Less than 5 minutes at room temp. or Less than 2 minutes at 40°C max.	Less than 1 minute 20W/L Frequency of several 10kHz to 100kHz.

A sufficient cleaning should be applied to remove flux completely.

(2) Drying

After cleaning, promptly dry this product.

3. Soldering Conditions

In your mounting process, observe the following points in order to avoid deterioration of the characteristics or destruction of this product. The mounting quality of this product may also be affected by the mounting conditions, shown in the points below.

This product is for reflow soldering only. Flow soldering should not be allowed.

(1) Printing Conditions of Solder Paste

- (a) Standard thickness of solder paste printing should be from 0.10 to 0.15 mm.
- (b) After soldering, the solder fillet should be a height from 0.15 mm to the thickness of this product (see the figure at right).
- (c) Too much solder gives too strong mechanical stress to this product. Such stress may cause cracking or other mechanical damage. Also, it can destroy the electrical performance of this product.

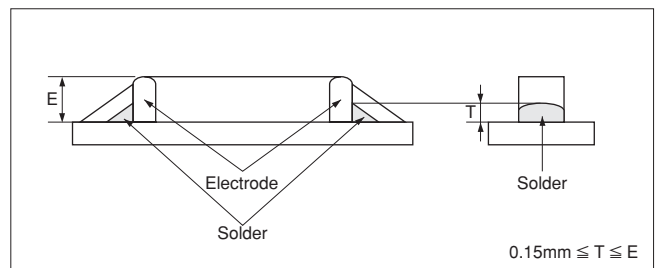

Continued on the following page. ↗

⚠Caution/Notice

☐ Continued from the preceding page.

(2) Reflow soldering conditions

The following figure and table show our recommended reflow profile.

- (a) Insufficient preheating may cause a crack on ceramic body. The temperature difference between preheat and peak should be control within 100°C to prevent this.
- (b) The excessive soldering conditions may cause dissolution of metallization or deterioration of solder-wetting on the external electrode.
- (c) Rapid cooling by dipping in solvent or by other means is not recommended.
- (d) Please evaluate it on your condition if you will do mounting using not applying condition to the above-mentioned.



- (3) There may be a risk of unexpected failures (tombstone, insufficient solder-wetting, etc.) in the mounting process, caused by the mounting conditions. Please make sure that this product is correctly mounted under specified mounting conditions.

⚠ Caution/Notice

■ Notice (Soldering and Mounting) PRF15_103R Series

1. Solder and Flux

(1) Solder Paste

Use solder paste Sn:Pb=63:37wt%.
 For your reference, we are using
 63Sn/37Pb RMA9086 90-3-M18,
 manufactured by Alpha Metals Japan Ltd.
 96.5Sn/3.0Ag/0.5Cu M705-GRN360-K2-V,
 manufactured by Senju Metal Industry Co., LTD for any
 Internal tests of this product.

(2) Flux

Use rosin type flux in soldering process.
 If below flux is used, some problems might be caused
 in the product characteristics and reliability.
 Please do not use below flux.

- Strong acidic flux (with halide content exceeding 0.2wt%).
- Water-soluble flux
 (*Water-soluble flux can be defined as non rosin type flux including wash-type flux and non-wash-type flux.)

2. Cleaning Conditions and Drying

To remove the flux after soldering, observe the following points in order to avoid deterioration of the characteristics or any change to the external electrodes quality.

(1) Cleaning Conditions

Solvent	Dipping Cleaning	Ultrasonic Cleaning
2-propanol	Less than 5 minutes at room temp. or Less than 2 minutes at 40°C max.	Less than 1 minute 20W/L Frequency of several 10kHz to 100kHz.

A sufficient cleaning should be applied to remove flux completely.

(2) Drying

After cleaning, promptly dry this product.

3. Soldering Conditions

In your mounting process, observe the following points in order to avoid deterioration of the characteristics or destruction of this product. The mounting quality of this product may also be affected by the mounting conditions, shown in the points below.

This product is for reflow soldering only. Flow soldering should not be allowed.

(1) Printing Conditions of Solder Paste

- (a) Standard thickness of solder paste printing should be from 0.10 to 0.15 mm.
- (b) After soldering, the solder fillet should be a height from 0.15 mm to the thickness of this product (see the figure at right).
- (c) Too much solder gives too strong mechanical stress to this product. Such stress may cause cracking or other mechanical damage. Also, it can destroy the electrical performance of this product.

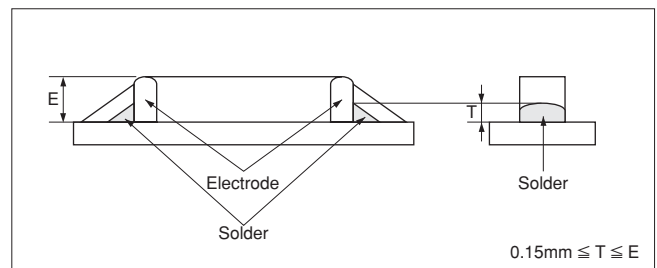

Continued on the following page. ↗

⚠Caution/Notice

☐ Continued from the preceding page.

(2) Allowable Soldering Temperature and Time

- (a) Solder within the temperature and time combinations, indicated by the slanted lines in the graphs at right.
- (b) The excessive soldering conditions may cause dissolution of metallization or deterioration of solder-wetting on the external electrode.
- (c) In case of repeated soldering, the accumulated soldering time should be within the range shown below figure. (For example, Reflow peak temperature: 260°C, twice → The accumulated soldering time at 260°C is within 30 sec.)



(3) Standard Temperature Profile for Soldering

- (a) Insufficient preheating may cause a crack on ceramic body. Difference between preheating temperature and maximum temperature in the profile should be 100°C.
- (b) Rapid cooling by dipping in solvent or by other means is not recommended.



- (4) There may be a risk of unexpected failures (tombstone, insufficient solder-wetting, etc.) in the mounting process, caused by the mounting conditions. Please make sure that this product is correctly mounted under specified mounting conditions.

⚠️ Caution/Notice

■ Notice (Soldering and Mounting) PRF18/21 Series

1. Solder and Flux

(1) Solder Paste

- (a) Flow Soldering: Use Sn:Pb=60:40wt%, Sn:Pb=63:37wt%, Sn:Ag:Cu=96.5:3.0:0.5wt% or equivalent type of solder.
- (b) Reflow Soldering: Use Sn:Pb=60:40wt%, Sn:Pb=63:37wt%, Sn:Ag:Cu=96.5:3.0:0.5wt% or equivalent type of solder paste.
 For your reference, we are using "63Sn/37Pb RMA9086 90-3-M18," manufactured by Alpha Metals Japan Ltd., "96.5Sn/3.0Ag/0.5Cu M705-GRN360-K2-V," manufactured by Senju Metal Industry Co., Ltd. for any internal tests of this product.

(2) Flux

Use rosin type flux in the soldering process. If the flux below is used, some problems might be caused in the product characteristics and reliability. Please do not use these types of flux.

- Strong acidic flux (with halide content exceeding 0.2wt%).
- Water-soluble flux
 (*Water-soluble flux can be defined as non-rosin type flux including wash-type flux and non-wash-type flux.)

2. Cleaning Conditions and Drying

To remove the flux after soldering, observe the following points in order to avoid deterioration of the characteristics or any change to the external electrodes' quality.

(1) Cleaning Conditions

Solvent	Dipping Cleaning	Ultrasonic Cleaning
2-propanol	Less than 5 minutes at room temp. or Less than 2 minutes at 40°C max.	Less than 1 minute 20W/L Frequency of several 10kHz to 100kHz.

A sufficient cleaning should be applied to remove flux completely.

(2) Drying

After cleaning, promptly dry this product.

3. Soldering Conditions

In your mounting process, observe the following points in order to avoid deterioration of the characteristics or destruction of this product. The mounting quality of this product may also be affected by the mounting conditions, shown in the points below.

(1) Printing Conditions of Solder Paste

- (a) Recommended thickness of solder paste printing should be from 0.15 to 0.20mm.
- (b) After soldering, the solder fillet should be a height from 0.2 mm to the thickness of this product (see the figure at right).
- (c) Too much solder result in excessive mechanical stress on this product. Such stress may cause cracking or other mechanical damage. Also, it can destroy the electrical performance of this product.

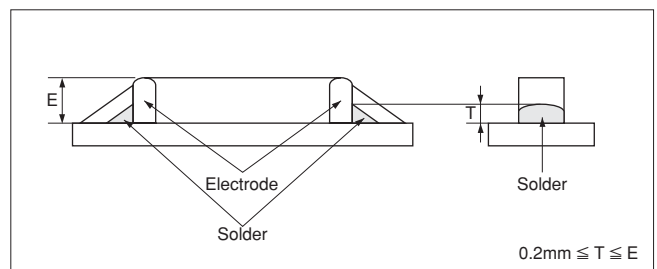

Continued on the following page. ↗

⚠️Caution/Notice

Continued from the preceding page.

(2) Adhesive Application and Curing

- (a) If insufficient adhesive is applied, or if the adhesive is not sufficiently hardened, this product may have a loose contact with the land, during flow soldering.
- (b) Too low viscosity of adhesive causes this product to slip on the board, after mounting.

(3) Allowable Soldering Temperature and Time

- (a) Solder within the temperature and time combinations, indicated by the slanted lines in the following graphs.
- (b) Excessive soldering conditions may cause dissolution of metallization or deterioration of solder-wetting on the external electrode.
- (c) In the case of repeated soldering, the accumulated soldering time should be within the range shown in the figures below. (For example, Reflow peak temperature: 260°C, twice → The accumulated soldering time at 260°C is within 30sec.)

Allowable Flow Soldering Temp. and Time



Allowable Reflow Soldering Temp. and Time



(4) Recommendable Temperature Profile for Soldering

- (a) Insufficient preheating may cause a crack on the ceramic body. The difference between preheating temperature and maximum temperature in the profile should be 100°C.
- (b) Rapid cooling by dipping in solvent or by other means is not recommended.

Flow Soldering Conditions



Preheating: 150±10°C, 1-2 minutes.
 Soldering: 250°C, 3 sec.

* In the case of repeated soldering, the accumulated soldering time should be within the range shown in "(3) Allowable Soldering Temperature and Time."

Reflow Soldering Conditions



Preheating: 150±10°C, 1-2 minutes.
 Soldering: 250°C, 20 sec.

* In the case of repeated soldering, the accumulated soldering time should be within the range shown in "(3) Allowable Soldering Temperature and Time."

- (5) There may be a risk of unexpected failures (tombstone, insufficient solder-wetting, etc.) in the mounting process caused by mounting conditions. Please make sure that this product is correctly mounted under the specified mounting conditions.

⚠Caution/Notice

■ Notice (Handling)

PTGL Series

1. Do not apply an excessive force to the lead.
Otherwise, it may cause the junction between lead and element to break, or may crack the element.
Therefore, holding the element side lead wire is recommended when lead wire is bent or cut.
2. This product does not have waterproof construction.
Splashed water may cause failure mode such as decline of characteristics or current leak.
3. When this product is operated, the temperature of some areas may be over 100 to 160 degrees C. Be sure that surrounding parts and inserting material can withstand the temperature. If the surrounding part and material are kept under such conditions, they may deteriorate or produce harmful gas (Chlorine gas, Hydrogen sulfide gas, Ammonia gas, Sulfuric acid gas, Nitric oxide gas, etc.), and such harmful gas may deteriorate the element.

■ Notice (Handling)

PTFL/PTFM Series

1. Do not apply an excessive force to the lead.
Otherwise, it may cause the junction between lead and element to break, or may crack the element.
Therefore, holding the element side lead wire is recommended when lead wire is bent or cut.
2. This product does not have waterproof construction.
Splashed water may cause failure mode such as decline of characteristics or current leak.

■ Notice (Handling)

PRG/PRF Series

1. When this product is operated, the temperature of some area may be over 100 to 150 degrees C. Be sure that surrounding parts and inserting material can withstand the temperature. If the surrounding parts and material are kept under such conditions, they may deteriorate or produce harmful gas (Chlorine gas, Hydrogen sulfide gas, Ammonia gas, Sulfuric acid gas, Nitric oxide gas, etc.), and such harmful gas may deteriorate the element.
2. Do not assemble this product with air-sealing or resin casting. Such sealing may deteriorate element.

Chip Type PRG/PRF Series Package

Minimum Quantity Guide

Part Number	Quantity (pcs.)	
	Paper Tape	Embossed Tape
PRF15_RC	10,000	-
PR*18_RB	4,000	-
PR*21_RA	-	4,000
PR*21_RK	-	3,000

Tape Dimensions



Reel Dimensions



Lead Type PTGL/PTF Series Package

■ Minimum Order Quantity (for Overcurrent Protection)

Series	Bulk Type		Ammo Pack Taping Type	
	Part Number	Min. Qty.	Part Number	Min. Qty.
Narrow Current Band 30V series	PTGL04AS100K2B51B0	500	PTGL04AS100K2B51A0	1500
	PTGL04AS100K2N51B0		PTGL04AS100K2N51A0	
	PTGL05AS3R9K2B51B0		PTGL05AS3R9K2B51A0	
	PTGL07AS2R7K2B51B0		PTGL07AS2R7K2B51A0	
	PTGL07AS1R8K2B51B0		PTGL07AS1R8K2B51A0	
	PTGL09AS1R2K2B51B0		PTGL09AS1R2K2B51A0	
	PTGL12AS0R8K2B51B0		PTGL12AS0R8K2B51A0	
Narrow Current Band 51V series	PTGL04AS100K3B51B0	500	PTGL04AS100K3B51A0	1500
	PTGL05AS6R8K3B51B0		PTGL05AS6R8K3B51A0	
	PTGL07AS3R3K3B51B0		PTGL07AS3R3K3B51A0	
	PTGL09AS2R2K3B51B0		PTGL09AS2R2K3B51A0	
	PTGL12AS1R2K3B51B0		PTGL12AS1R2K3B51A0	
Narrow Current Band 60V series	PTGL04AS220K4B51B0	500	PTGL04AS220K4B51A0	1500
	PTGL04AS220K4N51B0		PTGL04AS220K4N51A0	
	PTGL05AS100K4B51B0		PTGL05AS100K4B51A0	
	PTGL07AS5R6K4B51B0		PTGL07AS5R6K4B51A0	
	PTGL07AS5R6K4N51B0		PTGL07AS5R6K4N51A0	
	PTGL09AS3R3K4B51B0		PTGL09AS3R3K4B51A0	
Narrow Current Band 140V series	PTGL04AS560K6B51B0	500	PTGL04AS560K6B51A0	1500
	PTGL05AS270K6B51B0		PTGL05AS270K6B51A0	
	PTGL07AS150K6B51B0		PTGL07AS150K6B51A0	
	PTGL09AS120K6B51B0		PTGL09AS120K6B51A0	
	PTGL09AS7R6K6B51B0		PTGL09AS7R6K6B51A0	
16V Series	PTGL05AR1R0M1B51B0	500	PTGL05AR1R0M1B51A0	2000
	PTGL06AR0R8M1B51B0		PTGL06AR0R8M1B51A0	
	PTGL07ARR47M1B51B0		PTGL07ARR47M1B51A0	
	PTGL09ARR33M1B51B0		PTGL09ARR33M1B51A0	
	PTGL10ARR27M1B51B0		PTGL10ARR27M1B51A0	
	PTGL12AR0R2M1B51B0		PTGL12AR0R2M1B51A0	
	PTGL14ARR15M1B51B0		-	
24V Series	PTGL07BD100N2B51B0	500	PTGL07BD100N2B51A0	1500
	PTGL07BD6R8N2B51B0		PTGL07BD6R8N2B51A0	
	PTGL09BD4R7N2B51B0		PTGL09BD4R7N2B51A0	
	PTGL09BD3R3N2B51B0		PTGL09BD3R3N2B51A0	
	PTGL09BD2R2N2B51B0		PTGL09BD2R2N2B51A0	
30V Series	PTGL04AR130H2B51B0	500	PTGL04AR130H2B51A0	1500
	PTGL07AR4R6H2B51B0		PTGL07AR4R6H2B51A0	
	PTGL09AR1R8H2B51B0		PTGL09AR1R8H2B51A0	
	PTGL12AR1R2H2B51B0		-	
32V Series	PTGL07BD470N3B51B0	500	PTGL07BD470N3B51A0	1500
	PTGL07BD330N3B51B0		PTGL07BD330N3B51A0	
	PTGL07BD220N3B51B0		PTGL07BD220N3B51A0	
	PTGL07BD150N3B51B0		PTGL07BD150N3B51A0	
56V Series	PTGL07AR220M3P51B0	500	PTGL07AR220M3P51A0	1500
	PTGL07AR8R2M3P51B0		PTGL07AR8R2M3P51A0	
	PTGL09AR150M3B51B0		PTGL09AR150M3B51A0	
	PTGL10AR3R9M3P51B0		PTGL10AR3R9M3P51A0	
	PTGL09AR4R7M3B51B0		PTGL09AR4R7M3B51A0	
	PTGL10AR3R9M3B51B0		PTGL10AR3R9M3B51A0	
PTGL14AR3R3M3B71B0	300	-	-	

Series	Bulk Type		Ammo Pack Taping Type	
	Part Number	Min. Qty.	Part Number	Min. Qty.
80V Series	PTGL05AR550H4P51B0	500	PTGL05AR550H4P51A0	1500
	PTGL07AR250H4B51B0		PTGL07AR250H4B51A0	
	PTGL09AR9R4H4B51B0		PTGL09AR9R4H4B51A0	
	PTGL12AR5R6H4B71B0	300	-	-
	PTGL13AR3R7H4B71B0		-	-
125V Series	PTGL05AR181M7P52B0	500	PTGL05AR181M7P52A0	1500
	PTGL07AR750M7B52B0		PTGL07AR750M7B52A0	
	PTGL09AR470M6B52B0	300	PTGL09AR470M6B52A0	1000
	PTGL09AR220M6B52B0		PTGL09AR220M6B52A0	
	PTGL12AR150M6B72B0		250	
140V Series	PTGL14AR100M6B72B0	150	-	-
	PTGL18AR6R8M6B72B0	100	-	-
	PTGL18AR4R7M6B72B0		-	-
	PTGL18AR3R3M6B72B0		-	-
	250V Series	PTGL07AR330M6A51B0	500	-
PTGL09AR220M6C61B0		300	-	-
PTGL10AR150M6C61B0			-	-
PTGL12AR100M6C01B0		250	-	-
PTGL13AR6R8M6C01B0		200	-	-
PTGL16AR5R6M6C01B0		150	-	-
265V Series	-	-	PTGL07BB220N0B52A0	1000
	-	-	PTGL09AR390N0B52A0	
	-	-	PTGL10BB120N0P52A0	
Less than 100µF Series	PTGL05AR151H8P52B0	500	PTGL05AR151H8P52A0	1000
	PTGL05AR181M9N51B0		-	-
	PTGL05AR121M9N51B0		-	-
	PTGL07AR820M9A51B0	300	-	-
	PTGL07AR700H8B52B0		PTGL07AR700H8B52A0	1000
	PTGL07AR650H8B52B0		PTGL07AR650H8B52A0	1000
	PTGL07AR450H8B52B0		PTGL07AR450H8B52A0	1000
	PTGL07AR560M9A51B0	200	-	-
	PTGL09AR390M9C61B0		-	-
	PTGL09AR250H8B52B0		PTGL09AR250H8B52A0	1000
PTGL12AR270M9C01B0	150	-	-	
PTGL12AR150H8B72B0		-	-	
PTGL14AR180M9C01B0		-	-	
PTGL13AR100H8B72B0		-	-	
PTGL18AR6R0H8B72B0	100	-	-	

■ Minimum Order Quantity (for Inrush Current Suppression)

Less than 100µF Series	PTGL07AS121M0N51B0	500	PTGL07AS121M0N51A0	1000
	PTGL07AS181M0N51B0	500	PTGL07AS181M0N51A0	1000
	PTGL07AS201M0N51B0	500	PTGL07AS201M0N51A0	1000
100µF or more Series	PTGL14AS470H0B02BZ	150	-	-
	PTGL16AS330H0B02BZ	150	-	-
	PTGL16AS470H0B02BZ	150	-	-
	PTGL16AS680H0B02BZ	150	-	-
	PTGL16AS101H0B02BZ	150	-	-
	PTGL20AS330H0D02BZ	100	-	-
PTGL20AS470H0D02BZ	100	-	-	

■ Minimum Order Quantity (for Overheat Sensing)

PTF Series	PTFL Series	400	-	-
	PTFM Series	200	-	-

Continued on the following page. ↗

Lead Type PTGL/PTF Series Package

☐ Continued from the preceding page.

■ Narrow Current Band 30 - 140V Series / 16 - 80V Series / Inrush Current Suppression Taping Dimensions



Item	Code	Dimensions (mm)	Note
Pitch of Component	P	12.7	Tolerance is determined by ΔS.
Pitch of Sprocket Hole	P ₀	12.7±0.3	
Lead Spacing	F	5.0 ^{+0.8} _{-0.3}	
Length from Hole Center to Lead	P ₁	3.85±0.8	
Length from Hole Center to Component Center	P ₂	6.35±1.3	Deviation in the feeding direction
Body Diameter	D	Please see in Ratings	
Body Thickness	T	Please see in Ratings	
Deviation along Tape, Left or Right Defect	ΔS	±1.5	Including the inclination caused by lead bending
Carrier Tape Width	W	18.0±0.5	
Position of Sprocket Hole	W ₁	9.0 ^{+0.5} _{-0.75}	Deviation of tape width
Lead Distance between Reference and Bottom Planes	H ₀	16.0±1.0	
	H ₂	6.0 max.	
Protrusion Length	l	+0.5 to -1.0	
Diameter of Sprocket Hole	D ₀	4.0±0.2	
Lead Diameter	d	Please see in Ratings	
Total Tape Thickness	t ₁	0.6±0.3	
Total Thickness of Tape and Lead Wire	t ₂	2.0 max.	
Deviation across Tape	Δh ₁ , Δh ₂	1.5 max.	
Portion to cut in Case of Defect	L	11.0 ⁺⁰ _{-2.0}	
Hold down Tape Width	W ₀	11.0 min.	
Hold down Tape Position	W ₂	4.0 max.	
Coating Extension on Lead	e	Up to the center of crimp	

Continued on the following page. ☐

Lead Type PTGL/PTF Series Package

Continued from the preceding page.

125/250/265V Series Taping Dimensions



Item	Code	Dimensions (mm)	Note
Pitch of Component	P	12.7	Tolerance is determined by ΔS.
Pitch of Sprocket Hole	P ₀	12.7±0.3	
Lead Spacing	F	5.0 ^{+0.8} _{-0.3}	
Length from Hole Center to Lead	P ₁	3.85±0.8	
Length from Hole Center to Component Center	P ₂	6.35±1.3	Deviation in the feeding direction
Body Diameter	D	Please see Ratings	
Body Thickness	T	Please see Ratings	
Deviation along Tape, Left or Right	ΔS	±1.5	Including the inclination caused by lead bending.
Carrier Tape Width	W	18.0±0.5	
Position of Sprocket Hole	W ₁	9.0 ^{+0.5} _{-0.75}	Deviation of tape width.
Lead Distance between Reference and Bottom Planes	H ₀	16.0±1.0	
	H ₂	6.0 max.	
Protrusion Length	l	+0.5 to -1.0	
Diameter of Sprocket Hole	D ₀	4.0±0.2	
Lead Diameter	d	0.6±0.05	
Total Tape Thickness	t ₁	0.6±0.3	
Total Thickness of Tape and Lead Wire	t ₂	2.0 max.	
Deviation across Tape	Δh ₁ , Δh ₂	1.5 max.	
Portion to cut in Case of Defect	L	11.0 ⁺⁰ _{-2.0}	
Hold down Tape Width	W ₀	11.0 min.	
Hold down Tape Position	W ₂	4.0 max.	
Coating Extension on Lead	e	Up to the center of crimp	

⚠Note:

1. Export Control

<For customers outside Japan>

No Murata products should be used or sold, through any channels, for use in the design, development, production, utilization, maintenance or operation of, or otherwise contribution to (1) any weapons (Weapons of Mass Destruction [nuclear, chemical or biological weapons or missiles] or conventional weapons) or (2) goods or systems specially designed or intended for military end-use or utilization by military end-users.

<For customers in Japan>

For products which are controlled items subject to the "Foreign Exchange and Foreign Trade Law" of Japan, the export license specified by the law is required for export.

2. Please contact our sales representatives or product engineers before using the products in this catalog for the applications listed below, which require especially high reliability for the prevention of defects which might directly damage a third party's life, body or property, or when one of our products is intended for use in applications other than those specified in this catalog.

- | | |
|-----------------------------|--|
| ① Aircraft equipment | ② Aerospace equipment |
| ③ Undersea equipment | ④ Power plant equipment |
| ⑤ Medical equipment | ⑥ Transportation equipment (vehicles, trains, ships, etc.) |
| ⑦ Traffic signal equipment | ⑧ Disaster prevention / crime prevention equipment |
| ⑨ Data-processing equipment | ⑩ Application of similar complexity and/or reliability requirements to the applications listed above |

3. Product specifications in this catalog are as of July 2012. They are subject to change or our products in it may be discontinued without advance notice. Please check with our sales representatives or product engineers before ordering. If there are any questions, please contact our sales representatives or product engineers.
4. Please read rating and ⚠CAUTION (for storage, operating, rating, soldering, mounting and handling) in this catalog to prevent smoking and/or burning, etc.
5. This catalog has only typical specifications. Therefore, please approve our product specifications or transact the approval sheet for product specifications before ordering.
6. Please note that unless otherwise specified, we shall assume no responsibility whatsoever for any conflict or dispute that may occur in connection with the effect of our and/or a third party's intellectual property rights and other related rights in consideration of your use of our products and/or information described or contained in our catalogs. In this connection, no representation shall be made to the effect that any third parties are authorized to use the rights mentioned above under licenses without our consent.
7. No ozone depleting substances (ODS) under the Montreal Protocol are used in our manufacturing process.