

HLMP-KA45

T-1 (3 mm) High Intensity InGaN Lamp



Data Sheet



Description

This blue LED is designed in an industry standard T-1 package with clear and non-diffused optics. This lamp is ideal for use as indicators and for general purpose lighting.

Applications

- Status indicators
- Small message panel
- Running and decorative lights for commercial use
- Back-lighting
- Consumer audio

Features

- Popular T1 diameter package
- General purpose leads
- Reliable and rugged
- Binned for color and intensity
- InGaN blue dice

Package Dimensions

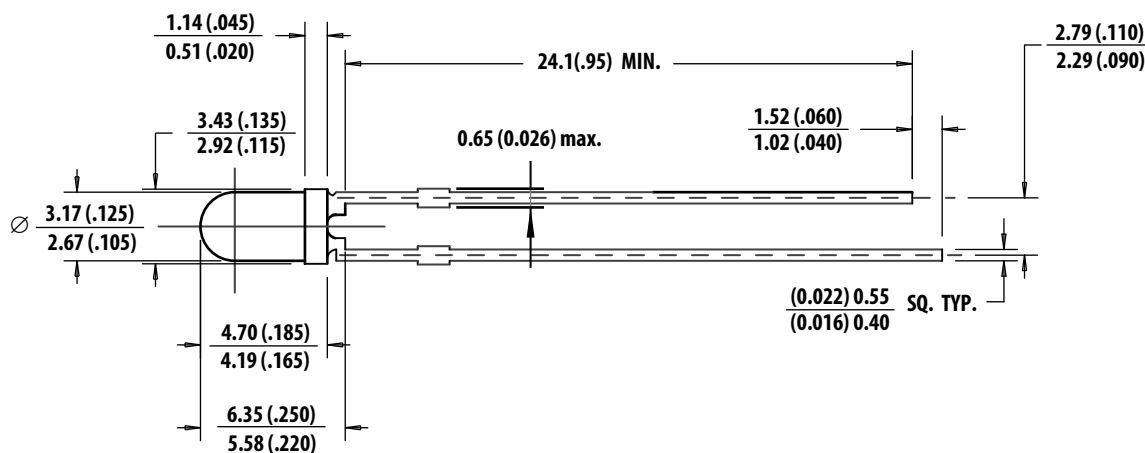

Notes:

1. All dimensions are in mm (inches).
2. An epoxy meniscus may extend about 1 mm (0.040") down the leads.
3. For PCB hole recommendations, see the Precautions section.

CAUTION: Devices are Class 1C HBM ESD sensitive per JEDEC Standard. Please observe appropriate precautions during handling and processing. For additional details, refer to Application Note AN-1142.

Ordering Information

HLMP-X X XX - X X X XX

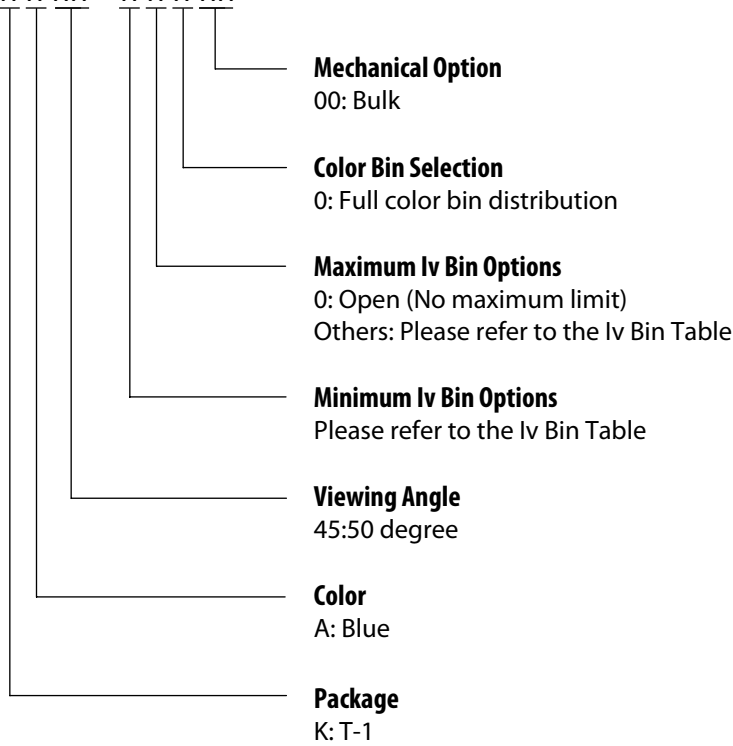

Absolute Maximum Ratings at $T_A = 25^\circ\text{C}$

Parameter	HLMP-KA45 (Blue)	Unit
DC Forward Current ^[1]	30	mA
Peak Pulsed Forward Current ^[2]	100	mA
Power Dissipation	116	mW
LED Junction Temperature	115	°C
Operating Temperature Range	-35 to +85	°C
Storage Temperature Range	-35 to +85	°C

Note:

1. Derate linearly as shown in Figure 4.
2. Duty factor = 10%, Frequency = 1 kHz.

Device Selection Guide

Part Number	Color and Dominant Wavelength λ_d (nm) Typ.	Luminous Intensity I_v (mcd) at 20 mA Min.	Luminous Intensity I_v (mcd) at 20 mA Max.
HLMP-KA45-E0000	Blue 470	85	–
HLMP-KA45-J0000	Blue 470	240	–
HLMP-KA45-NQ000	Blue 470	680	1500

Notes:

1. The luminous intensity is measured on the mechanical axis of the lamp package.
2. The optical axis is closely aligned with the package mechanical axis.
3. The dominant wavelength, λ_d is derived from the CIE Chromaticity Diagram and represents the color of the lamp.

Electrical /Optical Characteristics Table at $T_A = 25^\circ\text{C}$

Parameter	Symbol	Min.	Typ.	Max.	Units	Test Conditions
Forward Voltage	V_F	2.8	3.2	3.8	V	$I_F = 20\text{ mA}$
Capacitance	C		40		pF	$V_F = 0, f = 1\text{ MHz}$
Thermal Resistance	$R_{\theta J-PIN}$		465		$^\circ\text{C/W}$	LED Junction-to-Cathode Lead
Viewing Angle	$2\theta_{1/2}$		50		deg	
Dominant Wavelength	λ_d		470		nm	$I_F = 20\text{ mA}$
Peak Wavelength	λ_P		464		nm	Peak of Wavelength of Spectral Distribution at $I_F = 20\text{ mA}$
Spectral Halfwidth	$\Delta\lambda_{1/2}$		24		nm	Wavelength Width at Spectral Distribution $1/2$ Power Point at $I_F = 20\text{ mA}$

Notes:

1. $2\theta_{1/2}$ is the off-axis angle where the luminous intensity is $1/2$ the on axis intensity.
2. The dominant wavelength, λ_d , is derived from the Chromaticity Diagram and represents the color of the lamp.

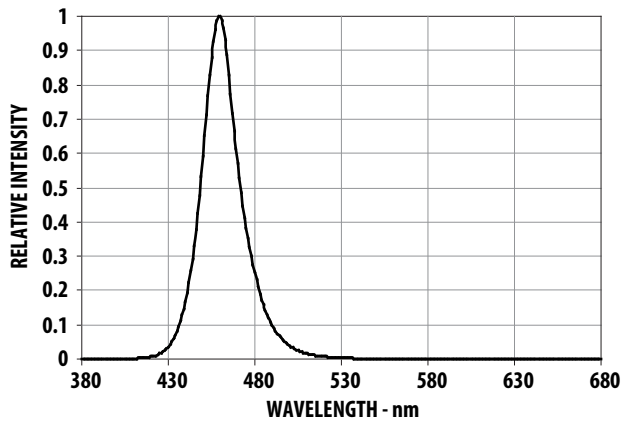

Figure 1. Relative Intensity vs. Wavelength

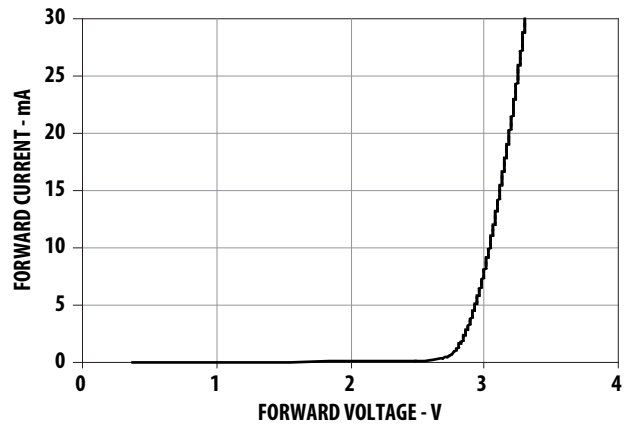

Figure 2. Forward Current vs. Forward Voltage

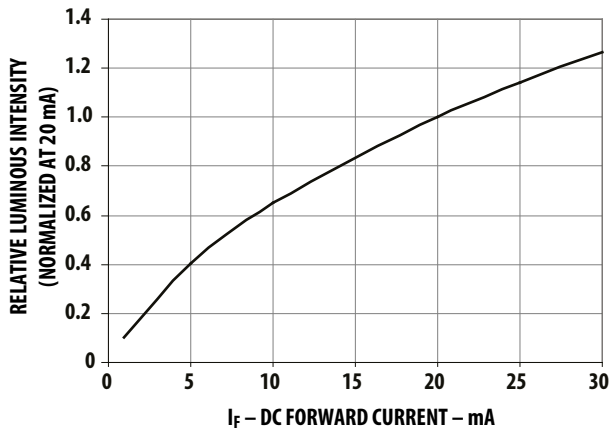

Figure 3. Relative luminous intensity vs. forward current

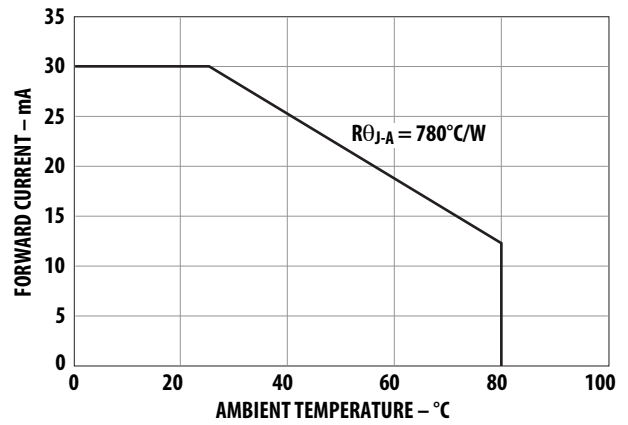

Figure 4. Maximum forward current vs. ambient temperature based on $T_{jmax} = 115^{\circ}C$

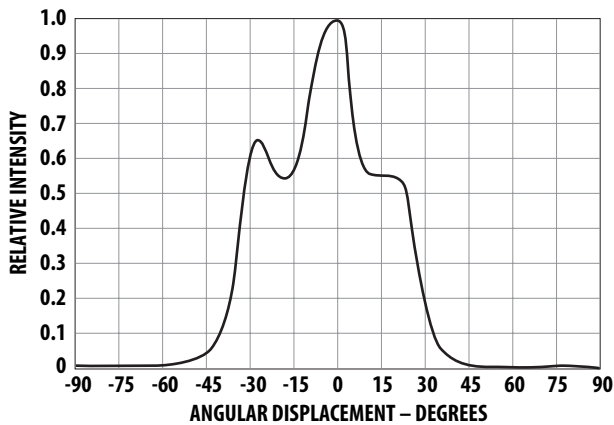

Figure 5. Radiation pattern

Intensity Bin Limit

Bin	Intensity (mcd) at 20 mA	
	Min	Max
E	85	110
F	110	140
G	140	180
H	180	240
J	240	310
K	310	400
L	400	520
M	520	680
N	680	880
P	880	1150
Q	1150	1500
R	1500	1900
S	1900	2500
T	2500	3200

Tolerance for each bin limit is $\pm 15\%$.

Color Categories

Color	Cat #	Lambda (nm)	
		Min.	Max.
Blue	1	460.0	464.0
	2	464.0	468.0
	3	468.0	472.0
	4	472.0	476.0
	5	476.0	480.0

Tolerance for each bin limit is ± 0.5 nm.

Mechanical Option Matrix

Mechanical Option Code	Definition
00	Bulk Packaging, minimum increment 500 pcs/bag

Note:

All categories are established for classification of products. Products may not be available in all categories. For further clarification/information, contact your local Avago representative.

Precautions

Lead Forming

- The leads of an LED lamp may be preformed or cut to length prior to insertion and soldering into PC board.
- If lead forming is required before soldering, care must be taken to avoid any excessive mechanical stress induced to LED package. Otherwise, cut the leads of LED to length after soldering process at room temperature. The solder joint formed will absorb the mechanical stress of the lead cutting from traveling to the LED chip die attach and wirebond.
- It is recommended that tooling made to precisely form and cut the leads to length rather than rely upon hand operation.

Soldering Conditions

- Care must be taken during PCB assembly and soldering process to prevent damage to LED component.
- The closest LED is allowed to solder on board is 1.59 mm below the body (encapsulant epoxy) for those parts without standoff.
- Recommended soldering conditions:

	Wave Soldering	Manual Solder Dipping
Pre-heat Temperature	105 °C Max.	–
Pre-heat Time	60 sec Max.	–
Peak Temperature	250 °C Max.	260 °C Max.
Dwell Time	3 sec Max.	5 sec Max.

- Wave soldering parameter must be set and maintained according to recommended temperature and dwell time in the solder wave. Customer is advised to periodically check on the soldering profile to ensure the soldering profile used is always conforming to recommended soldering condition.
- If necessary, use fixture to hold the LED component in proper orientation with respect to the PCB during soldering process.
- Proper handling is imperative to avoid excessive thermal stresses to LED components when heated. Therefore, the soldered PCB must be allowed to cool to room temperature, 25 °C, before handling.
- Special attention must be given to board fabrication, solder masking, surface plating and lead holes size and component orientation to assure solderability.
- Recommended PC board plated through hole sizes for LED component leads:

	LED Component Lead Size	Diagonal	Plated Through-Hole Diameter
Lead size (typ.)	0.45 × 0.45 mm (0.018 × 0.018 in.)	0.636 mm (0.025 in)	0.98 to 1.08 mm (0.039 to 0.043 in)
Dambar shear-off area (max.)	0.65 mm (0.026 in)	0.919 mm (0.036 in)	
Lead size (typ.)	0.50 × 0.50 mm (0.020 × 0.020 in.)	0.707 mm (0.028 in)	1.05 to 1.15 mm (0.041 to 0.045 in)
Dambar shear-off area (max.)	0.70 mm (0.028 in)	0.99 mm (0.039 in)	

Note:

Refer to application note AN1027 for more information on soldering LED components.

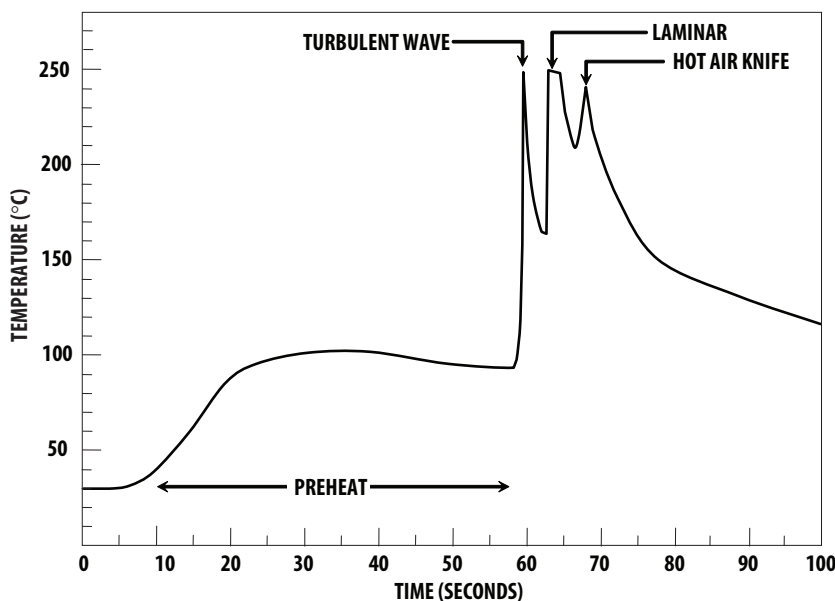

Recommended solder:
Sn63 (Leaded solder alloy)
SAC305 (Lead-free solder alloy)

Flux: Rosin flux

Solder bath temperature:
245 °C ± 5 °C (maximum peak temperature = 250 °C)







Dwell time: 1.5 sec – 3.0 sec (maximum = 3 sec)

Note: Allow for board to be sufficiently cooled to room temperature before you exert mechanical force.

Figure 5. Recommended wave soldering profile

Packing Label

(i) Avago Mother Label: (Available on packaging box of ammo pack and shipping box)

	
(1P) Item: Part Number 	STANDARD LABEL LS0002 RoHS Compliant e3 max temp 250C
(1T) Lot: Lot Number 	(Q) QTY: Quantity 
LPN: 	CAT: Intensity Bin 
(9D)MFG Date: Manufacturing Date 	BIN: Color Bin 
<hr/>	
(P) Customer Item: 	
(V) Vendor ID: 	(9D) Date Code: Date Code 
<hr/>	
DeptID: 	Made In: Country of Origin 

(ii) Avago Baby Label (Only available on bulk packaging)

	
Lamps Baby Label	
RoHS Compliant e3 max temp 250C	
(1P) PART #: Part Number 	
(1T) LOT #: Lot Number 	
(9D)MFG DATE: Manufacturing Date 	QUANTITY: Packing Quantity 
C/O: Country of Origin 	
<hr/>	
Customer P/N: 	CAT: Intensity Bin 
Supplier Code: 	BIN: Color Bin 
	DATECODE: Date Code 

For product information and a complete list of distributors, please go to our web site: www.avagotech.com

Avago, Avago Technologies, and the A logo are trademarks of Avago Technologies in the United States and other countries. Data subject to change. Copyright © 2005-2015 Avago Technologies. All rights reserved.
AV02-0921EN - May 13, 2015

AVAGO
TECHNOLOGIES