

SURFACE MOUNT LED WHITE, 2835 PACKAGE, 0.2W

BIVAR

SM2835UWDX02

- ◆ Industry Standard 2835 Package
- ◆ RoHS Compliant
- ◆ Small Package and Footprint
- ◆ X - (C) Cool White, (N) Neutral White, (W) Warm White
- ◆ Wide Viewing Angle
- ◆ Ideal for Lighting and Backlighting Application

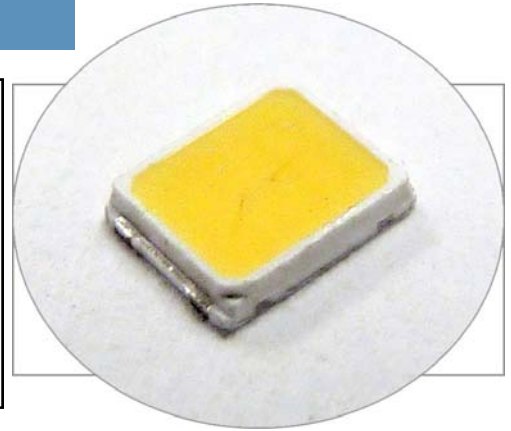

Bivar Surface Mount 2835 package LED may be used in nearly any lighting or backlighting application. These 0.2 Watt SMD LED's have a minimum CRI Value of 80 and are available in 3 color temperatures to meet any illumination needs: Cool, Neutral and Warm White. The SM2835 Series is conveniently packaged in standard tape and reels for pick and place assemblies.

| Part Number | Material | Emitted Color | Lens Color | Luminous Flux (lm) TYP. | Viewing Angle |
|--------------|----------|---------------|------------|-------------------------|---------------|
| SM2835UWDC02 | InGaN | Cool White | Diffused | 24 | 120° |
| SM2835UWDN02 | InGaN | Neutral White | Diffused | 23 | 120° |
| SM2835UWDW02 | InGaN | Warm White | Diffused | 22 | 120° |

Outline Dimensions

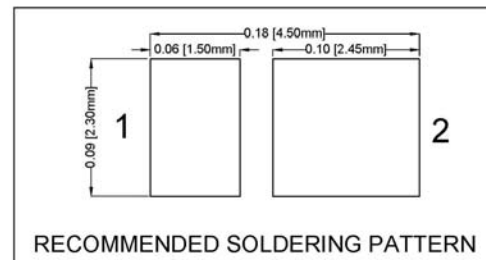
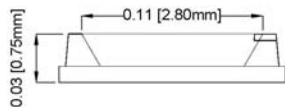
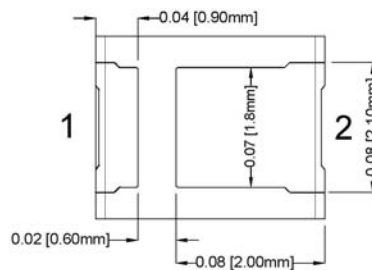
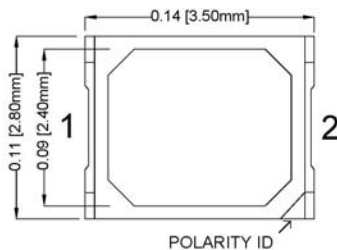

Outline Drawings Notes:

1. All dimensions are in inches [millimeters].
2. Standard tolerance: ± 0.010 unless otherwise noted.



Bivar reserves the right to make changes at any time without notice.

Absolute Maximum Ratings

$T_A = 25^\circ\text{C}$ unless otherwise noted

| | |
|---|--------------|
| Power Dissipation | 0.26 W |
| Forward Current (DC) | 75 mA |
| Peak Forward Current ¹ | 120 mA |
| Reverse Voltage | 5 V |
| Electrostatic Discharge (HBM) | 2000 V |
| Operating Temperature Range | -40 ~ +100°C |
| Storage Temperature Range | -40 ~ +100°C |
| Junction Temperature | 115°C |
| Lead Soldering Temperature ² | 260°C |

Notes: 1. $\leq 10\%$ Duty Cycle, Pulse Width ≤ 0.1 msec.
2. Solder time less than 5 seconds at temperature extreme.

Electrical / Optical Characteristics

$T_A = 25^\circ\text{C}$ & $I_F = 60$ mA unless otherwise noted

| Part Number | Forward Voltage (V) | | | Recommend Forward Current (mA) | Reverse Current (μA) $V_R=5\text{V}$ | CCT (Kelvin) | | | Luminous Flux (lm) | | | Viewing Angle $2\theta_{1/2}$ (deg) |
|--------------|---------------------|-----|-----|--------------------------------|--|--------------|------|------|--------------------|-----|-----|---|
| | MIN | TYP | MAX | TYP | MAX | MIN | TYP | MAX | MIN | TYP | MAX | TYP |
| SM2835UWDC02 | 2.9 | / | 3.5 | 60 | 10 | 5800 | 6500 | 7300 | 20 | 24 | 28 | 120 |
| SM2835UWDN02 | 2.9 | / | 3.5 | 60 | 10 | 3700 | 4000 | 4400 | 20 | 23 | 28 | 120 |
| SM2835UWDW02 | 2.9 | / | 3.5 | 60 | 10 | 2750 | 3000 | 3150 | 20 | 22 | 26 | 120 |

Notes: 1. The above forward voltage measurement allowance tolerance is $\pm 0.1\text{V}$.
2. The above luminous flux measurement allowance tolerance $\pm 10\%$.

SURFACE MOUNT LED WHITE, 2835 PACKAGE, 0.2W



Typical Electrical / Optical Characteristics

$T_A = 25^\circ\text{C}$ unless otherwise noted

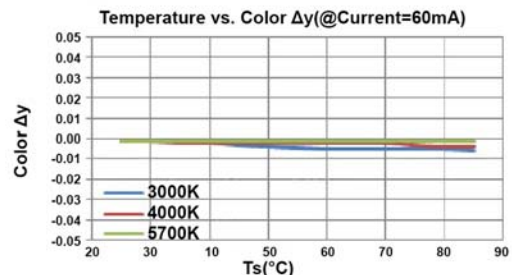
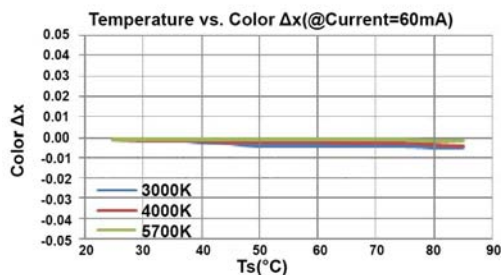
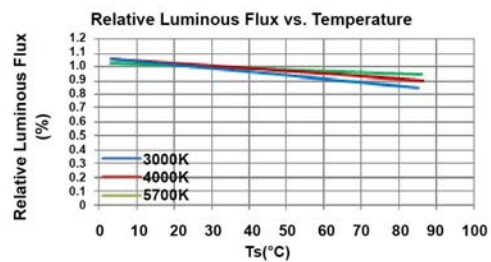
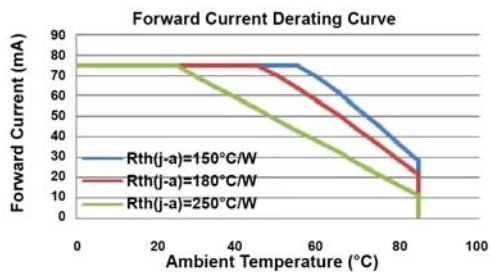
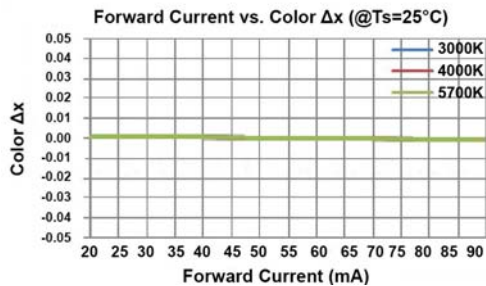
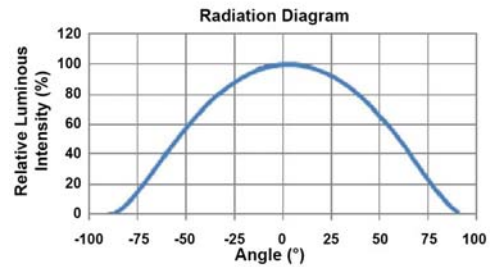
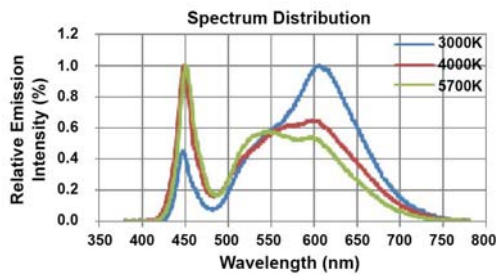
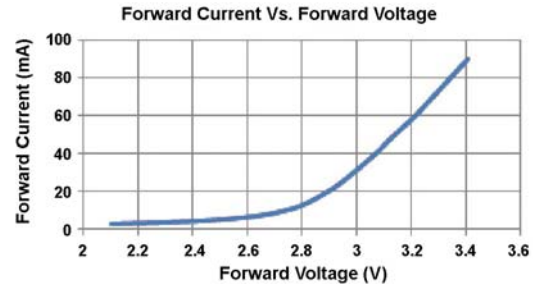
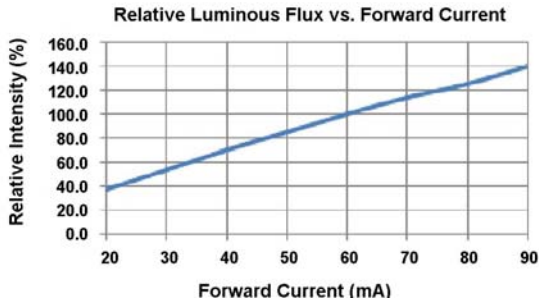

Bivar reserves the right to make changes at any time without notice.

SURFACE MOUNT LED WHITE, 2835 PACKAGE, 0.2W



Recommended Soldering Conditions

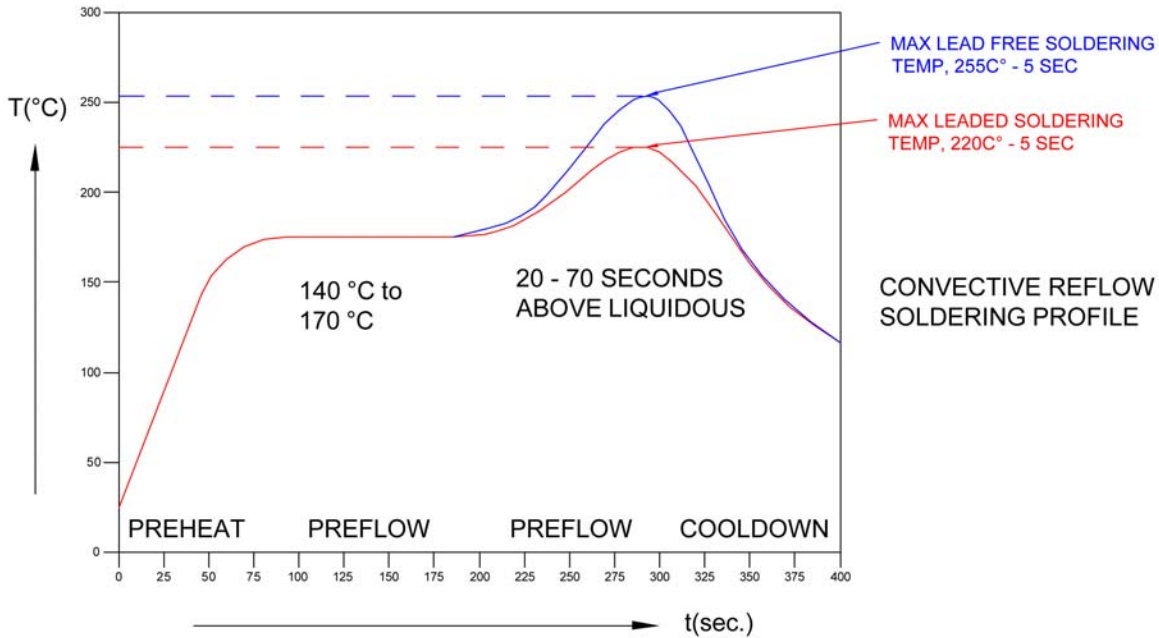

Tape and Reel Dimensions

Note: 4000 pcs/Reel

• Dimensions of Tape

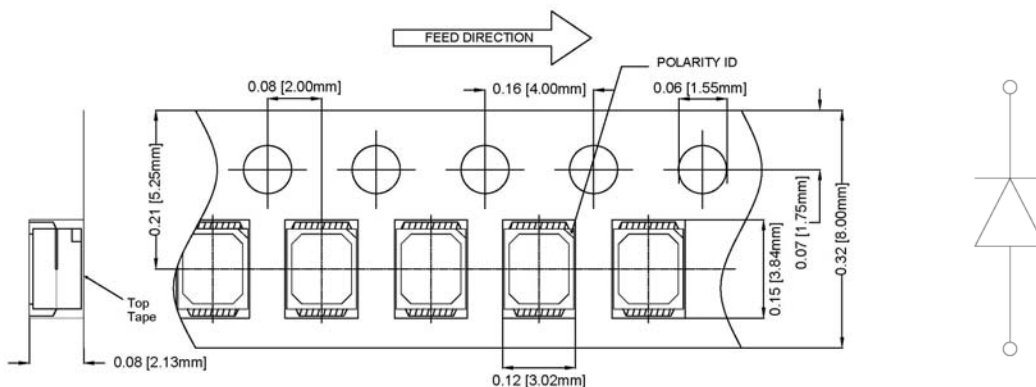

• Arrangement of Tape

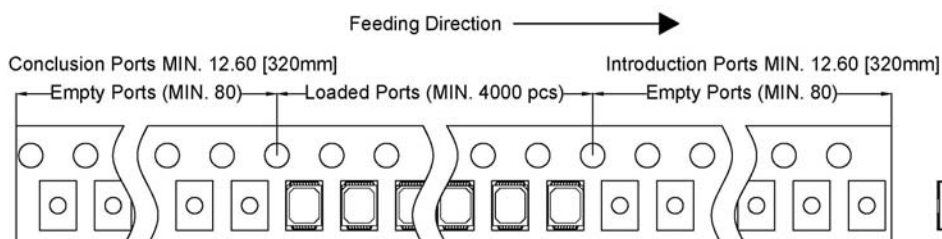

Outline Drawings Notes:

1. All dimensions are in inches [millimeters].
2. Standard tolerance: $\pm 0.010''$ unless otherwise noted.

Bivar reserves the right to make changes at any time without notice.

SURFACE MOUNT LED WHITE, 2835 PACKAGE, 0.2W

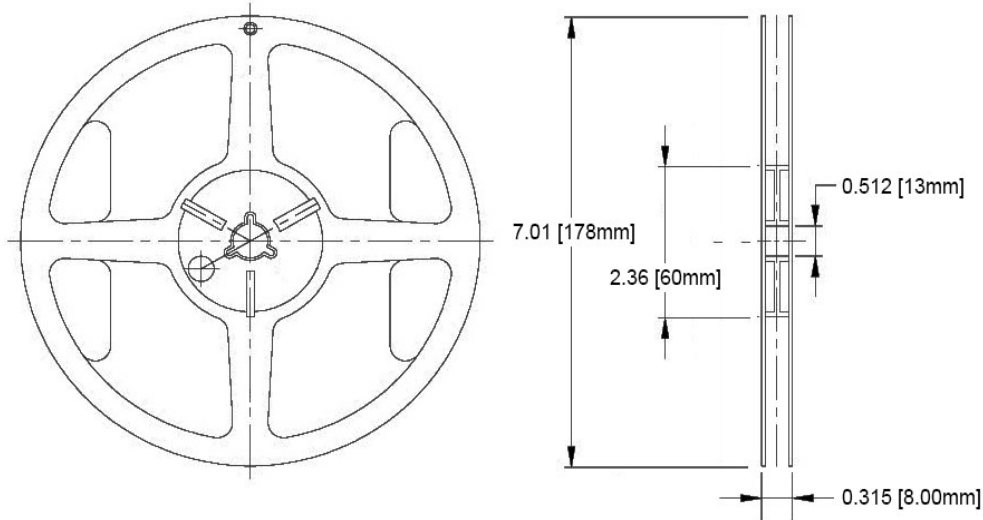

Outline Drawings Notes:

1. All dimensions are in inches [millimeters].
2. Standard tolerance unless otherwise noted: X.XXX ± 0.010"
X.X ± 0.1"

Packaging and Labeling Plan

Note: 1 Reel / Bag

Vacuum and Heat Sealed
ESD/MBB Bag

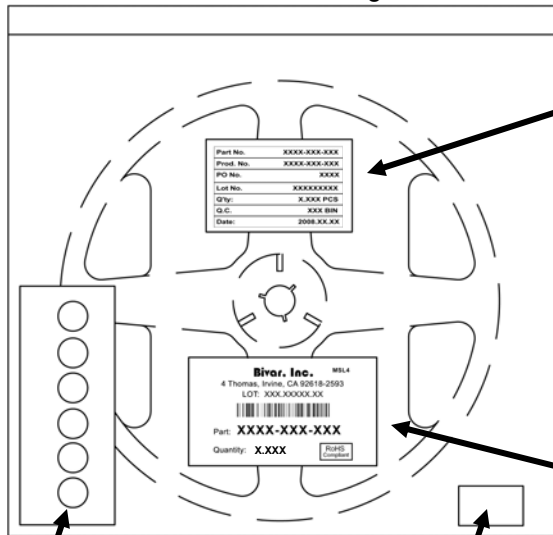

Humidity Indicator Card

Desiccants

| | |
|-----------|--------------|
| Part No. | XXXX-XXX-XXX |
| Prod. No. | XXXX-XXX-XXX |
| PO No. | XXXX |
| Lot No. | XXXXXXXXXX |
| Q'ty: | X.XXX PCS |
| Q.C. | XXX BIN |
| Date: | 2008.XX.XX |

Internal Quality Control

Bivar, Inc. MSL4

4 Thomas, Irvine, CA 92618-2593
LOT: XXX.XXXXX.XX



Part: **XXXX-XXX-XXX**

Quantity: **X.XXX**

RoHS
Compliant

Bivar Standard Packaging Label

Bivar reserves the right to make changes at any time without notice.