

# Hallogic Hall-Effect Sensor Assembly



## OHB900

### Features:

- Non-contact motion sensing
- Operates over a broad range of supply voltages (4.5 V to 25 V)
- Excellent temperature stability
- Hall element, linear amplifier and Schmitt trigger on a single Hallogic silicon chip
- Performs in dirty environments over wide temperature range
- 0.125" (3.18 mm) wide gap

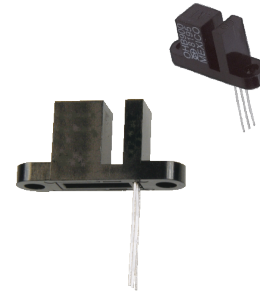

### Description:

The OHB900 consists of a Hall-effect sensor similar to the OH180U and a rare earth magnet mounted in a low-cost plastic housing. The magnet produces optimum magnetic flux at the Hall-effect sensor location. The sensor has an open collector transistor output, which is activated when the slot is open. When the slot is blocked by a ferrous material that reduces the magnetic flux density at the Hall-effect sensor location, the open collector output transistor switches off. The device provides up to 25 mA of sink current. Output characteristics are constant at switching frequencies from DC to over 200 kHz.

The Uni-Polar turns on with a (logic level "0") after a sufficient magnetic field from the south pole of a magnet approaches the symbolized face of the device (Operating Point) and turns off (logic level "1") after the magnetic field reached a minimum value. This feature makes these sensors ideal for applications in non-contact switching operations.

### Applications:

- Non-contact slotted magnetic switch
- Harsh environment encoder
- Assembly line automation
- Machine automation
- Machine safety
- End of travel sensor
- Door sensor

Ordering Information	
Part Number	Description
OHB900	Slotted Switch

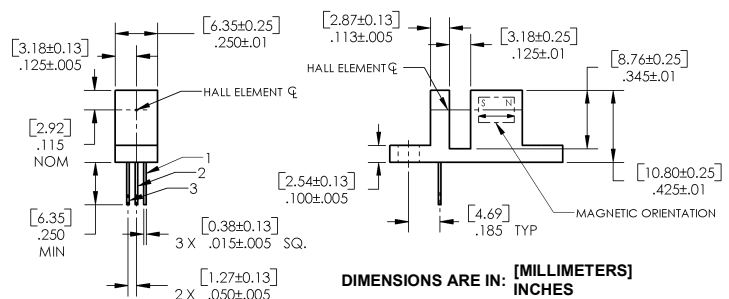
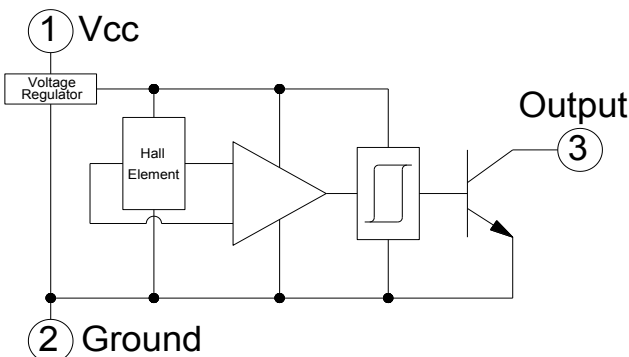
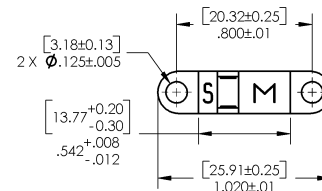

Pin #	Description
1	Vcc
2	Ground
3	Output



### General Note

TT Electronics reserves the right to make changes in product specification without notice or liability. All information is subject to TT Electronics' own data and is considered accurate at time of going to print.

TT Electronics | Optek Technology, Inc.  
1645 Wallace Drive, Ste. 130, Carrollton, TX USA 75006 | Ph: +1 972 323 2200  
www.ttelectronics.com | sensors@ttelectronics.com

# Halloglic Hall-Effect Sensor Assembly



## Electrical Specifications

**Absolute Maximum Ratings** ( $T_A = 25^\circ\text{C}$  unless otherwise noted)

Supply Voltage, $V_{CC}$	25 V
Storage Temperature Range, $T_S$	-50°C to +160°C
Operating Temperature Range, $T_A$	-40°C to +150°C
Lead Soldering Temperature (1/8 in. (3.2 mm) from case for 5 sec. with soldering iron)	260°C
Output ON Current, $I_{SINK}$	25 mA
Output OFF Voltage, $V_{OUT}$	25 V
Magnetic Flux Density, $B$	Unlimited

**Electrical Characteristics** ( $T_A = 25^\circ\text{C}$  unless otherwise noted)

SYMBOL	PARAMETER	MIN	TYP	MAX	UNITS	TEST CONDITIONS
$I_{CC}$	Supply Current	-	4	7	mA	$V_{CC} = 24\text{ V}$ , Output Off
$V_{OL}$	Output Saturation Voltage	-	100	400	mV	$V_{CC} = 4.5\text{ V}$ , $I_{OL} = 20\text{ mA}$ , Slot Open
$I_{OH}$	Output Leakage Current	-	0.1	10	$\mu\text{A}$	$V = 4.5\text{ V}$ , $V_{OUT} = 24\text{ V}$ , Slot Blocked <sup>(1)</sup>
$t_r$	Output Rise Time	-	0.21	1	$\mu\text{s}$	$R_L = 820\ \Omega$ , $C_L = 20\text{ pF}$
$t_f$	Output Fall Time	-	0.1	1	$\mu\text{s}$	$R_L = 820\ \Omega$ , $C_L = 20\text{ pF}$

Notes:

- (1) Slot blocked with a ferrous material to interrupt magnetic flux.
- (2) See Hall-effect data sheet OH090 through OHS3100 Series for additional information — for reference only.

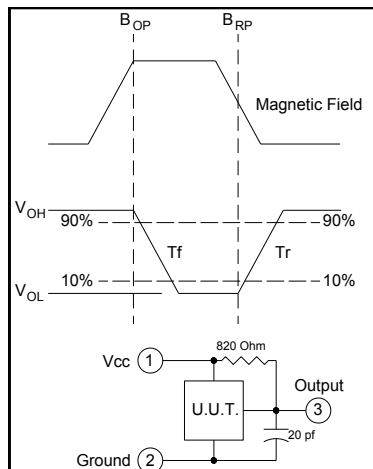

	Right Operate Point	Right Release Point	Left Release Point	Left Operate Point
Minimum	0.073" [1,85mm]	0.045" [1,14mm]	-0.045" [-1,14mm]	-0.073" [-1,85mm]
Maximum	0.003" [0,08mm]	-0.005" [-0,127mm]	0.005" [0,127mm]	-0.003" [-0,08mm]

Measurements are referenced to Center Line.

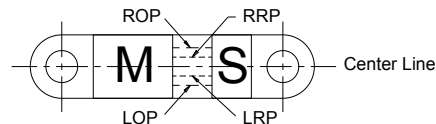

Vane - Material = 1018 Cold Rolled Steel - 0.03" [0.76mm] Thick  
Location = 0.50" [12.7mm] from Bottom of Slot

**General Note**

TT Electronics reserves the right to make changes in product specification without notice or liability. All information is subject to TT Electronics' own data and is considered accurate at time of going to print.

TT Electronics | Optek Technology, Inc.  
1645 Wallace Drive, Ste. 130, Carrollton, TX USA 75006 | Ph: +1 972 323 2200  
www.ttelectronics.com | sensors@ttelectronics.com

## Performance

### Rise & Fall vs Temperature

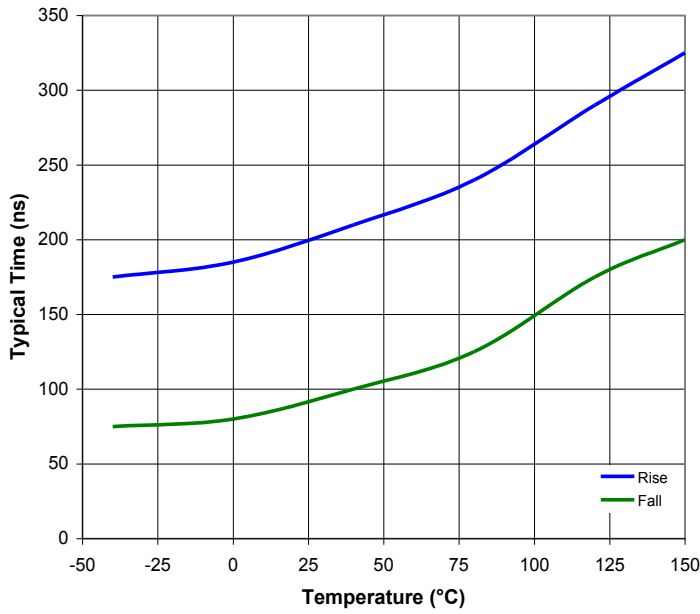

### Icc vs Temperature

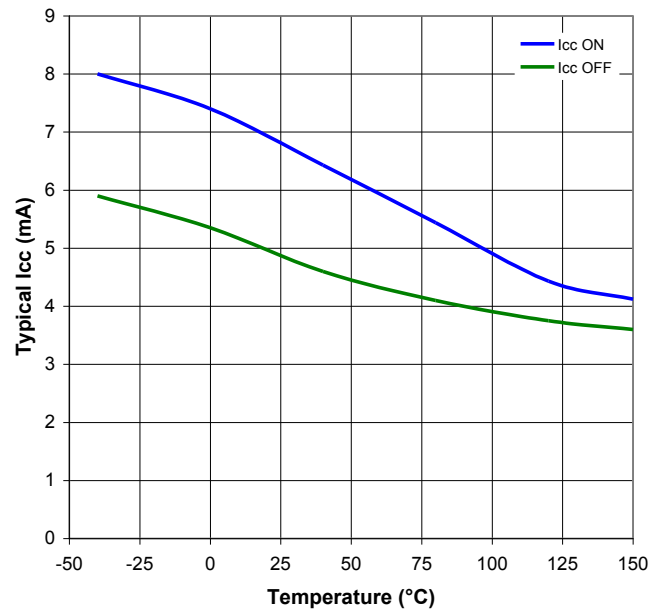

### Saturation Voltage vs Temperature

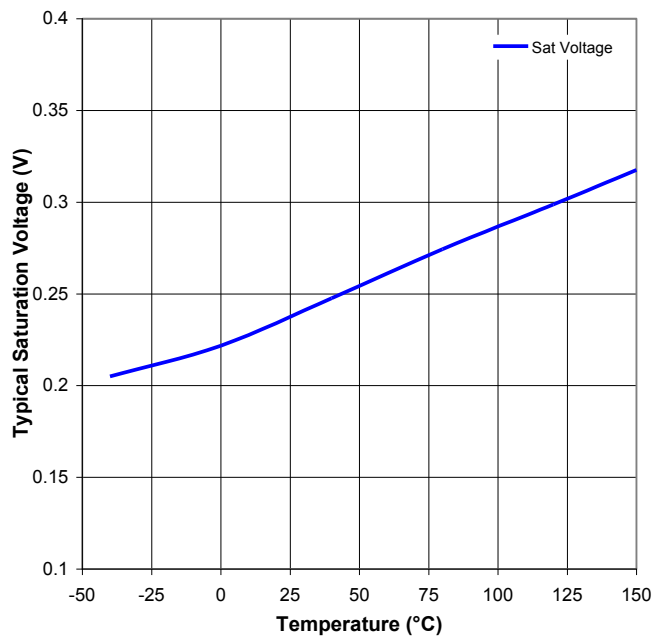

#### General Note

TT Electronics reserves the right to make changes in product specification without notice or liability. All information is subject to TT Electronics' own data and is considered accurate at time of going to print.

TT Electronics | Optek Technology, Inc.  
 1645 Wallace Drive, Ste. 130, Carrollton, TX USA 75006 | Ph: +1 972 323 2200  
[www.ttelectronics.com](http://www.ttelectronics.com) | [sensors@ttelectronics.com](mailto:sensors@ttelectronics.com)