

Series: RAZORBACK

PART NUMBER: RAZ32011MM, RAZ32012MM, RAZ42111MM,
RAZ42112MM, RAZ52211MM, RAZ52212MM, RAZ62311MM, RAZ62312MM



RAZ62311MM (Black)



RAZ62312MM (White)

Features:

- 2x LTE 644-2700MHz (MiMo)
- 0, 1x, 2x or 3x WiFi 2.4/5GHz
- DSRC
- GNSS Active:
 - Beidou, GPS, Glonass
 - RHCP polarization
 - Amplifier Gain 30dBi
- Size: 89.2 x 195.1 x 94.7mm
3.51 x 7.68 x 3.73 in
- Power withstanding 45W
- Available Models
 - RAZ32011MM = 3 Cable, Black
 - RAZ32012MM = 3 Cable, White
 - RAZ42111MM = 4 Cable, Black
 - RAZ42112MM = 4 Cable, White
 - RAZ52211MM = 5 Cable, Black
 - RAZ52212MM = 5 Cable, White
 - RAZ62311MM = 6 Cable, Black
 - RAZ62312MM = 6 Cable, White

Applications:

- Vehicular use Telematics
- Fleet management
- Trucking
- Navigation, GIS and survey
- Public safety
- Search and Rescue
- Metering, Utility boxes

Issue: 1742

In the effort to improve our products, we reserve the right to make changes judged to be necessary.

CONFIDENTIAL AND PROPRIETARY INFORMATION

This document contains confidential and proprietary information of Pulse Electronics, Inc. (Pulse) and is protected by copyright, trade secret and other state and federal laws. Its receipt or possession does not convey any rights to reproduce, disclose its contents, or to manufacture, use or sell anything it may describe. Reproduction, disclosure or use without specific written authorization of Pulse is strictly forbidden.

For more information:

Pulse Worldwide Headquarters
15255 Innovation Drive #100
San Diego, CA 92128
USA
Tel: 1-858-674-8100

Pulse/Larsen Antennas
18110 SE 34th St Bldg 2 Suite 250
Vancouver, WA 98683
USA
Tel: 1-360-944-7551

Europe Headquarters
Pulse GmbH & Do, KG
Zeppelinstrasse 15
Herrenberg, Germany
Tel: 49 7032 7806 0

Pulse (Suzhou) Wireless Products Co, Inc.
99 Huo Ju Road(#29 Bldg,4th Phase
Suzhou New District
Jiangsu Province, Suzhou 215009 PR China
Tel: 86 512 6807 9998



Series: RAZORBACK

PART NUMBER: RAZ32011MM, RAZ32012MM, RAZ42111MM,
RAZ42112MM, RAZ52211MM, RAZ52212MM, RAZ62311MM, RAZ62312MM

ELECTRICAL SPECIFICATIONS

Antenna Type	Monopole, measured on Ø1.02m (40") ground plane
Frequency (2x LTE)	644-960/1710-2700 MHz
Frequency (1x, 2x or 3x WiFi)	2400-2500/4900-5925 MHz
Nominal Impedance	50 Ω
VSWR	2:1
Radiation Pattern	Omni
HPBW / Vertical Plane (LTE, 644-960)	42°
HPBW / Vertical Plane (LTE, 1710-2700)	31°
HPBW / Vertical Plane (WIFI, 2400-2500)	25°
HPBW / Vertical Plane (WIFI, 4900-5925)	20°
Polarization	Vertical
Average Peak Gain (LTE, 644-960) (LTE, 1710-2700)	4.6/4.9 dBi
Average Peak Gain (WIFI, 2400-2500) (WIFI, 4900-5925)	6/6.6 dBi
Isolation (LTE1 to LTE2)	<-13
Isolation (WiFi1/2, WiF2/3 & WiFi1/3)	<-13
Average Efficiency (LTE)	67 %
Average Efficiency (WiFi)	57 %
Power Withstanding	45 W
GNSS Beidou-GPS-Glonass	
Frequency	1561.098±2.046,1575.42±1.023,1602.5625±4 MHz
VSWR	2:1
Nominal Impedance	50 Ω
Gain (Radiating element)	1 dBic +/- 1dB
Gain (LNA gain)	30 dB +/- 2 dB
Polarization	RHCP

Series: RAZORBACK

PART NUMBER: RAZ32011MM, RAZ32012MM, RAZ42111MM,
RAZ42112MM, RAZ52211MM, RAZ52212MM, RAZ62311MM, RAZ62312MM

ELECTRICAL SPECIFICATIONS

Out of Band Rejection	960MHz >65 dB, 1710MHz >60 dB, 2170MHz >65 dB, 2400MHz >65 dB
Noise Figure	< 2.4dB
Operating Voltage	3.3 - 5 Vdc ± 0.5 V
Current Consumption	< 11 mA

MECHANICAL SPECIFICATIONS

Length/Height/Width	195.1mm (7.68")/94.7 (3.73")/89.2mm (3.51")
Weight	856 g (1.9 lbs)
Antenna Color / Material	Black or White / PC/ABS, UV protected
Cable / Connector	2x LTE, 5.2m (17') LMR-195/SMA-Male 1x, 2x or 3x WiFi, 5.2m (17') LMR-195/RP-SMA-Male GNSS, 5.2m (17') RG-174/SMA-Male
Mounting Configuration	Magnetic Mount

ENVIRONMENTAL SPECIFICATIONS

Operating Temperature	-40/+85° C
Ingress Protection	IP67
RoHS Compliant	Yes

OTHER SPECIFICATIONS

Total cable assembly loss for 5.2m (17') LMR-195 @ 850MHz	2.1 dB
Total cable assembly loss for 5.2m (17') RG-174 @ 1575MHz	6.0 dB
Total cable assembly loss for 5.2m (17') LMR-195 @ 1930MHz	3.2 dB
Total cable assembly loss for 5.2m (17') LMR-195 @ 2500MHz	3.7 dB
Total cable assembly loss for 5.2m (17') LMR-195 @ 2450MHz	3.6 dB
Total cable assembly loss for 5.2m (17') LMR-195 @ 5350MHz	5.5 dB

Series: RAZORBACK

PART NUMBER: RAZ32011MM, RAZ32012MM, RAZ42111MM,
RAZ42112MM, RAZ52211MM, RAZ52212MM, RAZ62311MM, RAZ62312MM

MECHANICAL DRAWING

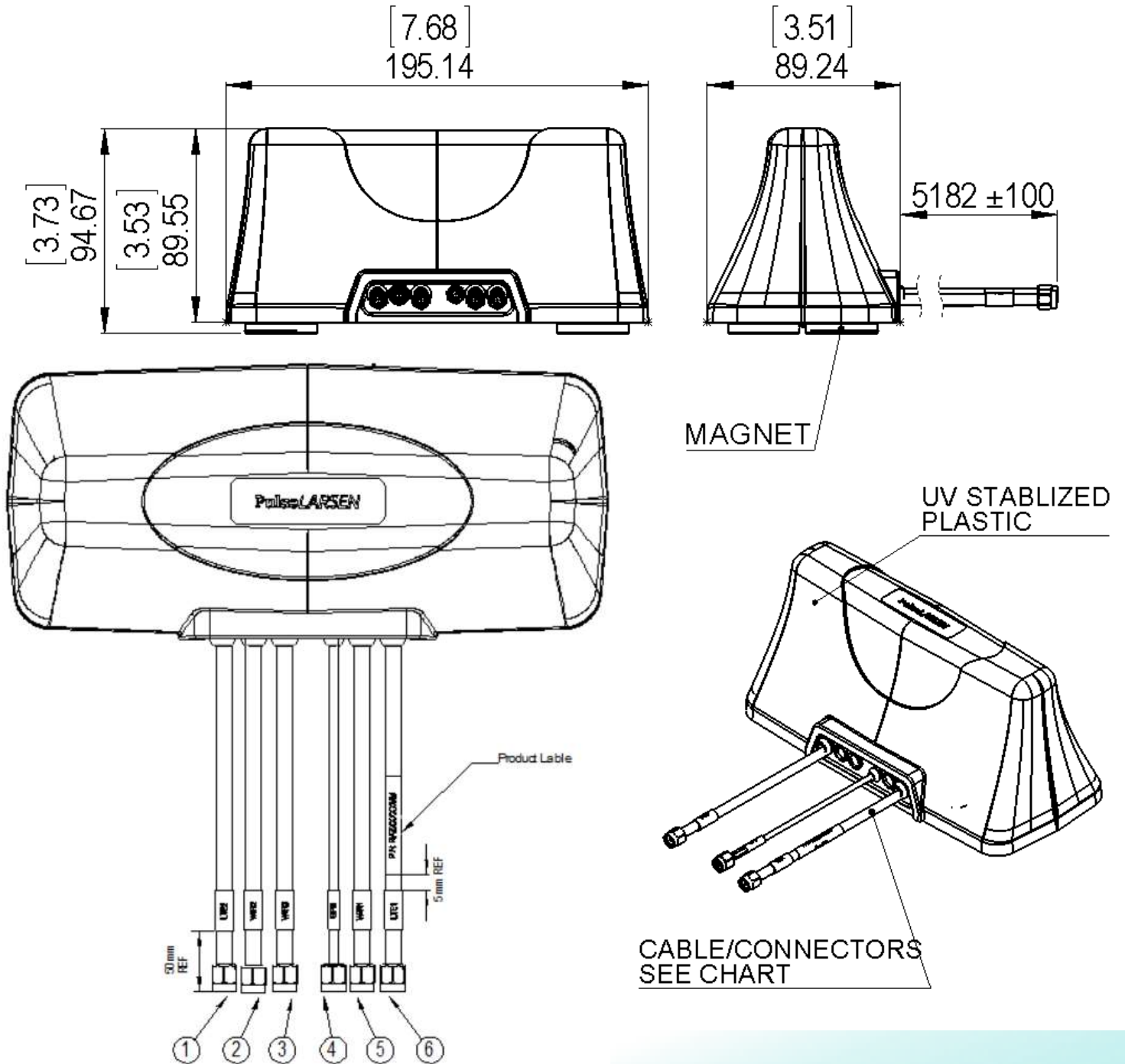

All dimensions are in mm / inches

Issue: 1742

In the effort to improve our products, we reserve the right to make changes judged to be necessary.

CONFIDENTIAL AND PROPRIETARY INFORMATION

This document contains confidential and proprietary information of Pulse Electronics, Inc. (Pulse) and is protected by copyright, trade secret and other state and federal laws. Its receipt or possession does not convey any rights to reproduce, disclose its contents, or to manufacture, use or sell anything it may describe. Reproduction, disclosure or use without specific written authorization of Pulse is strictly forbidden.

Description: GNSS / 2x LTE / 0, 1x, 2x or 3x WiFi
Magnetic Mount

Series: RAZORBACK

PART NUMBER: RAZ32011MM, RAZ32012MM, RAZ42111MM,
RAZ42112MM, RAZ52211MM, RAZ52212MM, RAZ62311MM, RAZ62312MM

MECHANICAL DRAWING

Vehicular Multiband Antenna with Magnet Mount

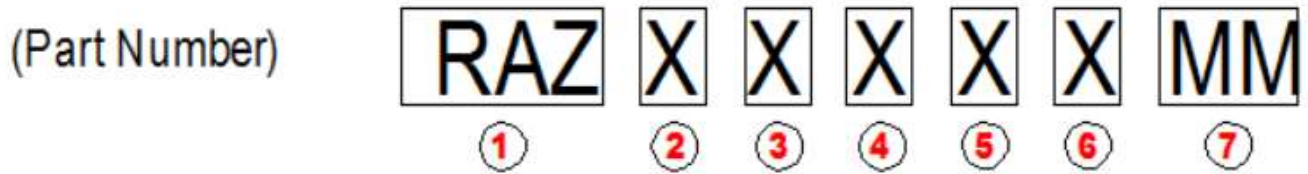

1	Product ID: RAZORBACK
2	Total Number of Cable leads
3	Total Number of LTE Cable Leads
4	Total Number of WiFi Cable Leads
5	Total Number of GPS Cable Leads
6	The Color of the Plastic Housing 1=Black; 2=White
7	Mounting: Magnet Mount

RAZXXXXMM		CABLE	CABLE LENGTH	CONNECTOR
1	LTE-2 Cable Assy	LMR195	5181 mm / 204" / 17 FT	SMA Male
2	WiFi-2 Cable Assy			RP-SMA Male
3	WiFi-3 Cable Assy			SMA Male
4	GPS Cable Assy	RG-174		RP-SMA Male
5	WiFi-1 Cable Assy	LMR195		SMA Male
6	LTE1 Cable Assy			

All dimensions are in mm / inches

Issue: 1742

In the effort to improve our products, we reserve the right to make changes judged to be necessary.

CONFIDENTIAL AND PROPRIETARY INFORMATION

This document contains confidential and proprietary information of Pulse Electronics, Inc. (Pulse) and is protected by copyright, trade secret and other state and federal laws. Its receipt or possession does not convey any rights to reproduce, disclose its contents, or to manufacture, use or sell anything it may describe. Reproduction, disclosure or use without specific written authorization of Pulse is strictly forbidden.

Series: RAZORBACK

PART NUMBER: RAZ32011MM, RAZ32012MM, RAZ42111MM,
RAZ42112MM, RAZ52211MM, RAZ52212MM, RAZ62311MM, RAZ62312MM

CHARTS

VSWR vs Frequency
RAZ62311MM Measured with 17' cables on Ø40" GP
Measured at Pulse, USA - July 07, 2017

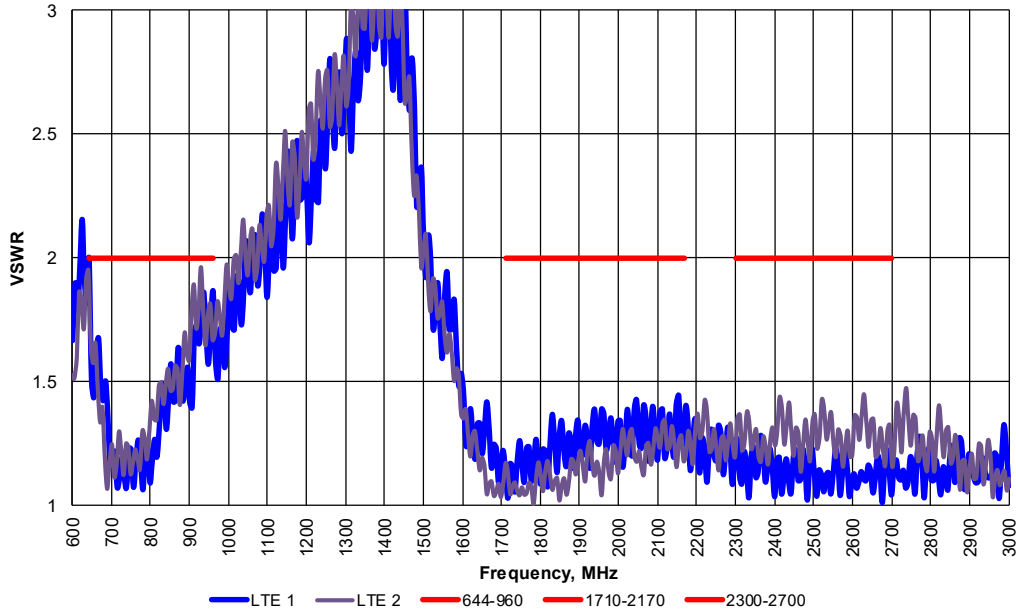

LTE 1 & 2
Measured with 5.2m
(17') cable

Return loss vs Frequency
RAZ62311MM Measured with 17' cables on Ø40" GP
Measured at Pulse, USA - July 07, 2017

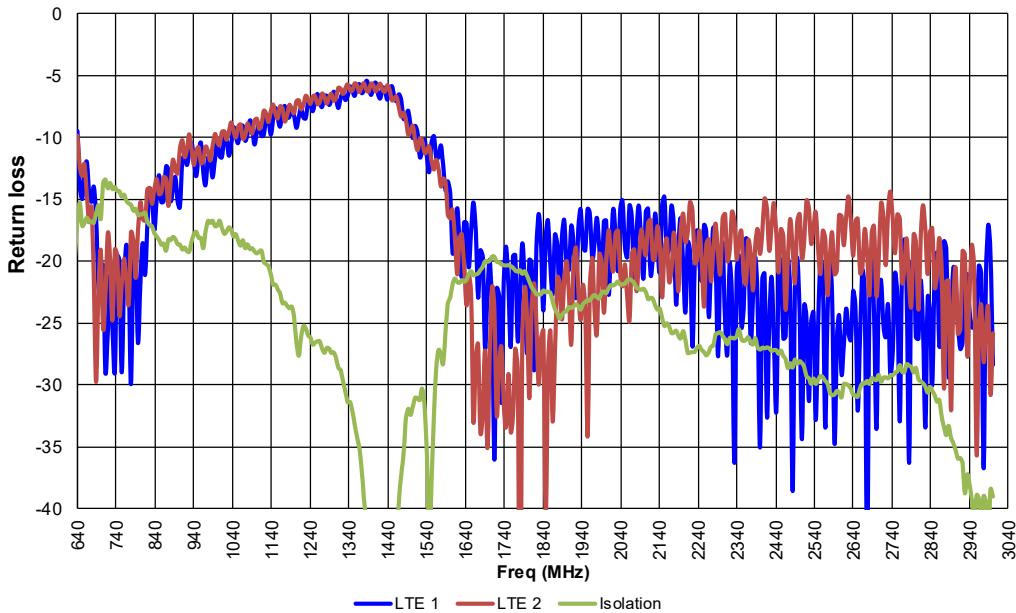

LTE 1 & 2
Measured with 5.2m
(17') cable

Issue: 1742

In the effort to improve our products, we reserve the right to make changes judged to be necessary.

CONFIDENTIAL AND PROPRIETARY INFORMATION

This document contains confidential and proprietary information of Pulse Electronics, Inc. (Pulse) and is protected by copyright, trade secret and other state and federal laws. Its receipt or possession does not convey any rights to reproduce, disclose its contents, or to manufacture, use or sell anything it may describe. Reproduction, disclosure or use without specific written authorization of Pulse is strictly forbidden.

Series: RAZORBACK

PART NUMBER: RAZ32011MM, RAZ32012MM, RAZ42111MM,
RAZ42112MM, RAZ52211MM, RAZ52212MM, RAZ62311MM, RAZ62312MM

CHARTS

VSWR vs Frequency
RAZ62311MM Measured with 17' cables on Ø40" GP (WiFi 1, 2 & 3)
Measured at Pulse, USA - July 07, 2017

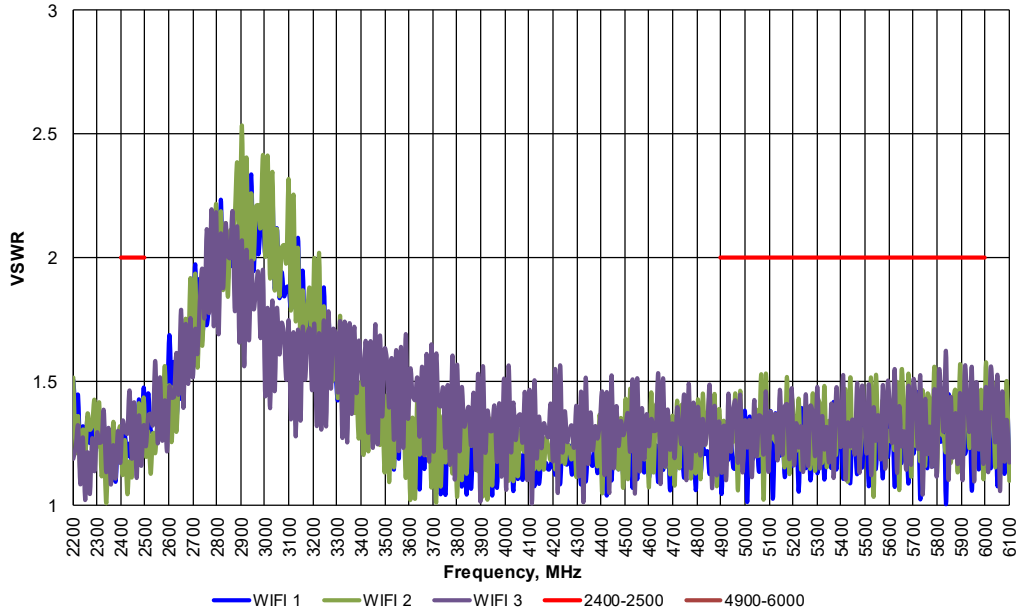

WiFi 1, 2 & 3
Measured with 5.2m
(17') cable

Return loss vs Frequency
RAZ62311MM Measured with 17' cables on Ø40" GP (WiFi 1, 2 & 3)
Measured at Pulse, USA - July 07, 2017

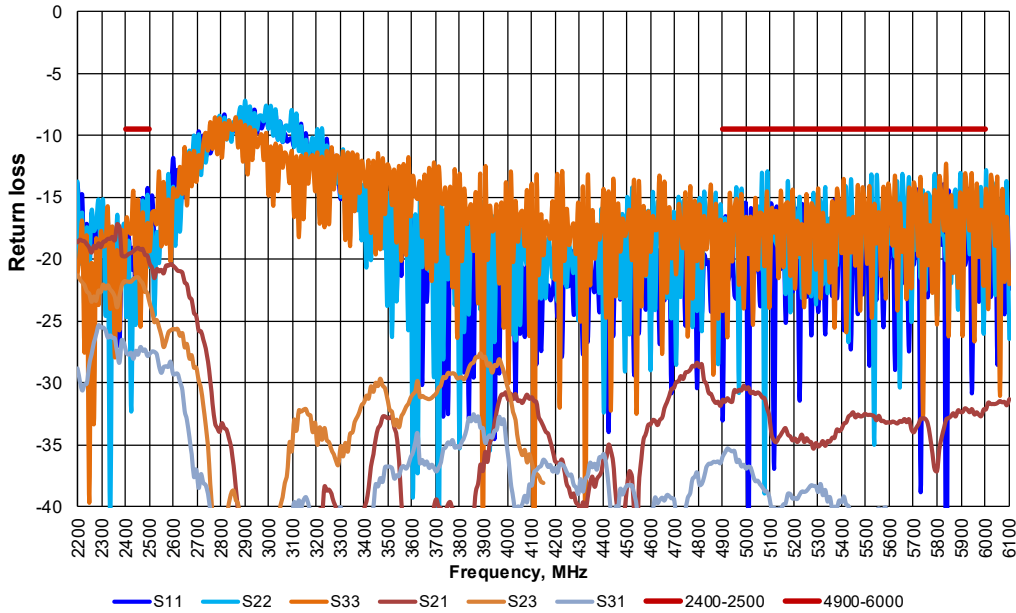

WiFi 1, 2 & 3
Measured with 5.2m
(17') cable

Issue: 1742

In the effort to improve our products, we reserve the right to make changes judged to be necessary.

CONFIDENTIAL AND PROPRIETARY INFORMATION

This document contains confidential and proprietary information of Pulse Electronics, Inc. (Pulse) and is protected by copyright, trade secret and other state and federal laws. Its receipt or possession does not convey any rights to reproduce, disclose its contents, or to manufacture, use or sell anything it may describe. Reproduction, disclosure or use without specific written authorization of Pulse is strictly forbidden.

Series: RAZORBACK

PART NUMBER: RAZ32011MM, RAZ32012MM, RAZ42111MM,
RAZ42112MM, RAZ52211MM, RAZ52212MM, RAZ62311MM, RAZ62312MM

CHARTS

Peak Gain vs Frequency
RAZ62311MM Measured with 3ft cables on Ø40" GP (LTE 1)
Measured at Pulse, USA - July 07, 2017

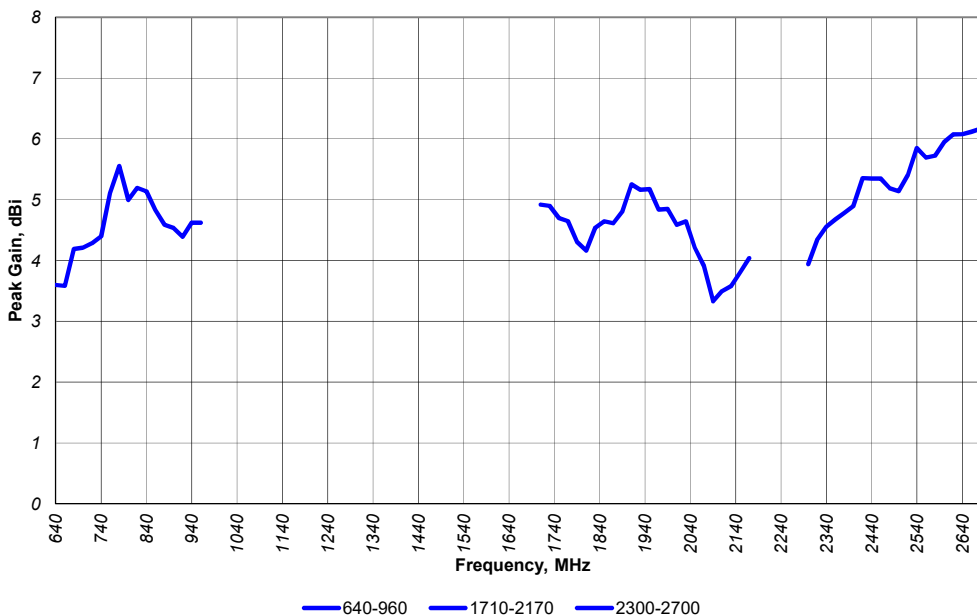

LTE 1
Measured with
914mm (36") cable

Efficiency vs Frequency
RAZ62311MM Measured with 3ft cables on Ø40" GP (LTE 1)
Measured at Pulse, USA - July 07, 2017

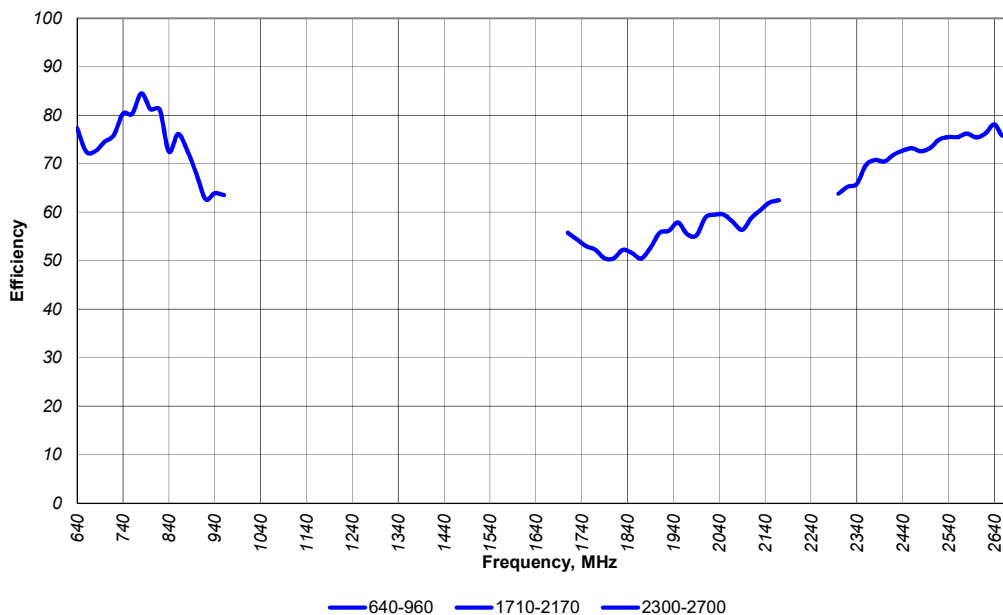

LTE 1
Measured with
914mm (36") cable

Issue: 1742

In the effort to improve our products, we reserve the right to make changes judged to be necessary.

CONFIDENTIAL AND PROPRIETARY INFORMATION

This document contains confidential and proprietary information of Pulse Electronics, Inc. (Pulse) and is protected by copyright, trade secret and other state and federal laws. Its receipt or possession does not convey any rights to reproduce, disclose its contents, or to manufacture, use or sell anything it may describe. Reproduction, disclosure or use without specific written authorization of Pulse is strictly forbidden.

Series: RAZORBACK

PART NUMBER: RAZ32011MM, RAZ32012MM, RAZ42111MM,
RAZ42112MM, RAZ52211MM, RAZ52212MM, RAZ62311MM, RAZ62312MM

CHARTS

LTE 1
Measured with
914mm (36") cable

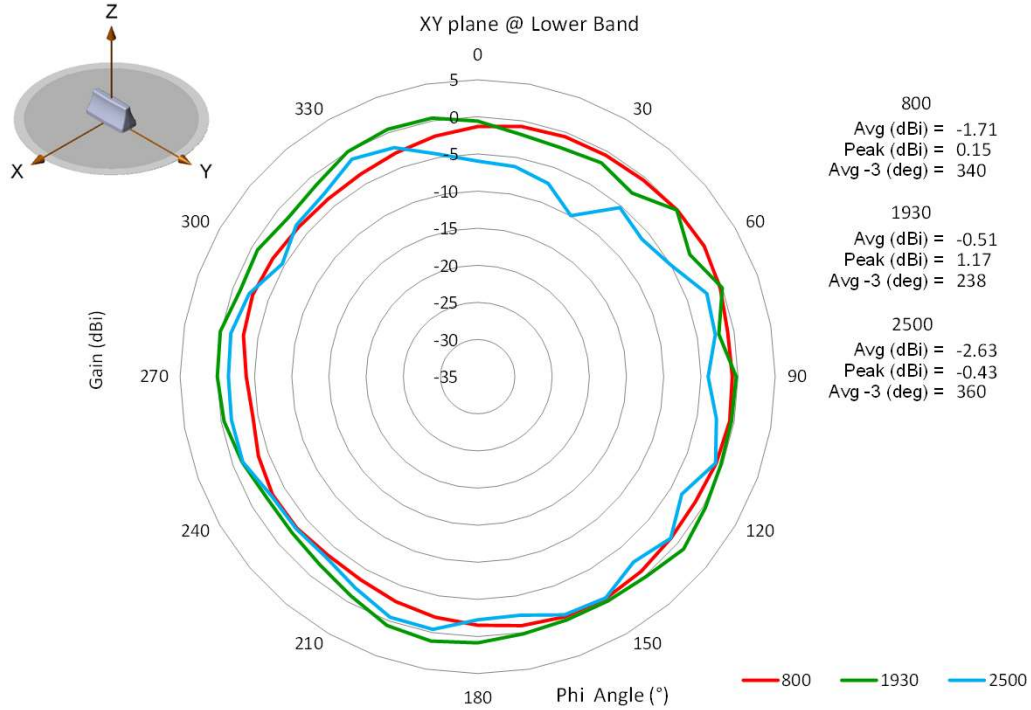

LTE 1
Measured with
914mm (36") cable

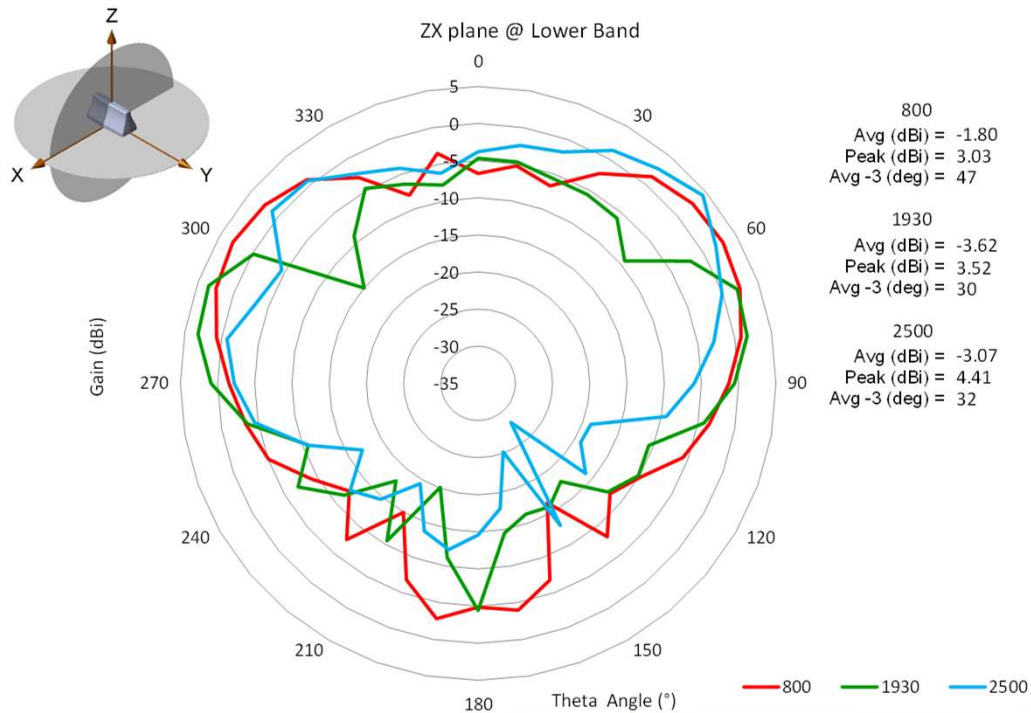

Issue: 1742

In the effort to improve our products, we reserve the right to make changes judged to be necessary.

CONFIDENTIAL AND PROPRIETARY INFORMATION

This document contains confidential and proprietary information of Pulse Electronics, Inc. (Pulse) and is protected by copyright, trade secret and other state and federal laws. Its receipt or possession does not convey any rights to reproduce, disclose its contents, or to manufacture, use or sell anything it may describe. Reproduction, disclosure or use without specific written authorization of Pulse is strictly forbidden.

CHARTS

Peak Gain vs Frequency
RAZ62311MM Measured with 3ft cables on Ø40" GP (LTE 2)
Measured at Pulse, USA - July 07, 2017

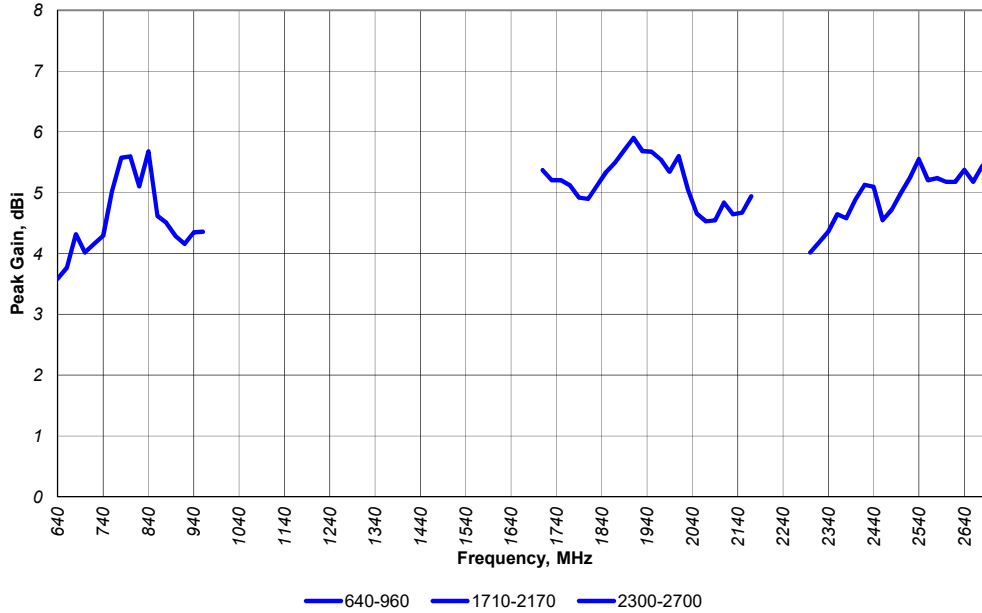

LTE 2
Measured with
914mm (36") cable

Efficiency vs Frequency
RAZ62311MM Measured with 3ft cables on Ø40" GP (LTE 2)
Measured at Pulse, USA - July 07, 2017

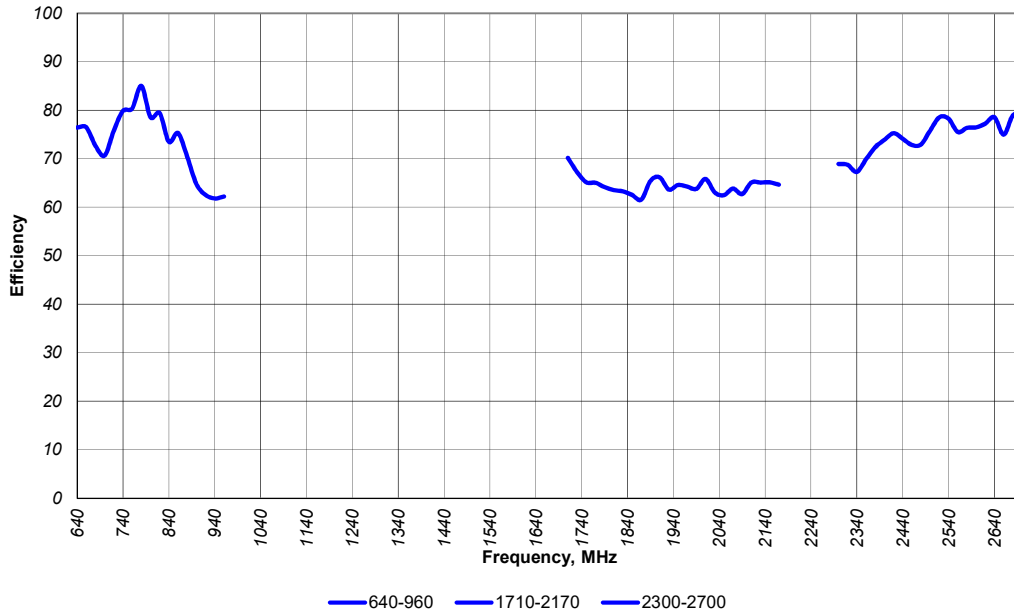

LTE 2
Measured with
914mm (36") cable

Issue: 1742

In the effort to improve our products, we reserve the right to make changes judged to be necessary.

CONFIDENTIAL AND PROPRIETARY INFORMATION

This document contains confidential and proprietary information of Pulse Electronics, Inc. (Pulse) and is protected by copyright, trade secret and other state and federal laws. Its receipt or possession does not convey any rights to reproduce, disclose its contents, or to manufacture, use or sell anything it may describe. Reproduction, disclosure or use without specific written authorization of Pulse is strictly forbidden.

Series: RAZORBACK

PART NUMBER: RAZ32011MM, RAZ32012MM, RAZ42111MM,
RAZ42112MM, RAZ52211MM, RAZ52212MM, RAZ62311MM, RAZ62312MM

CHARTS

LTE 2
Measured with
914mm (36") cable

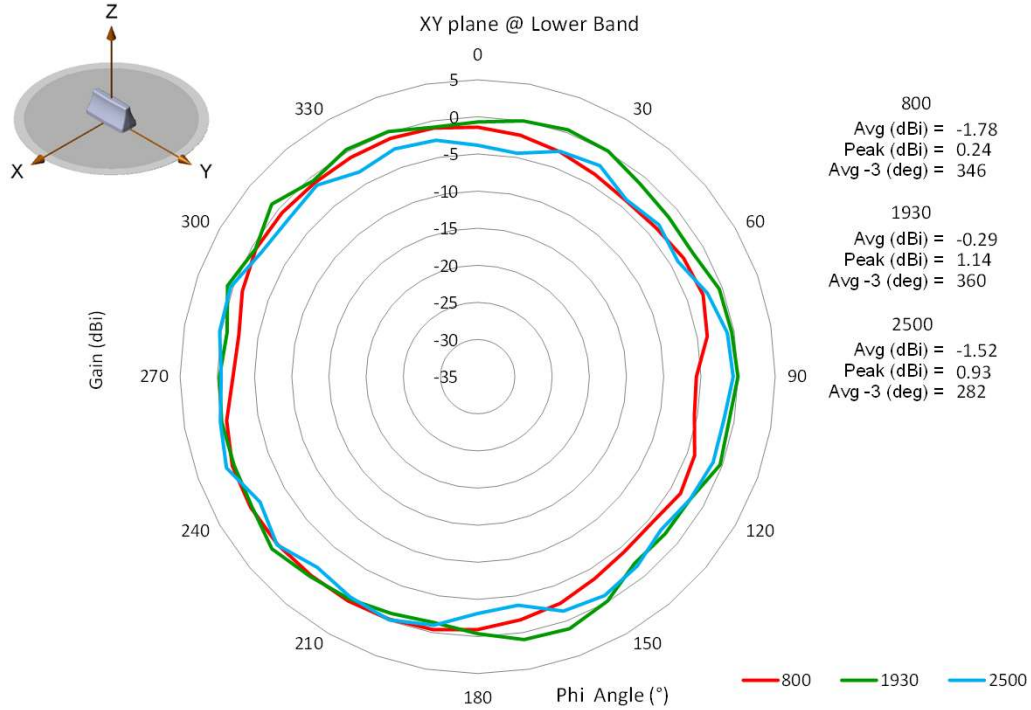

LTE 2
Measured with
914mm (36") cable

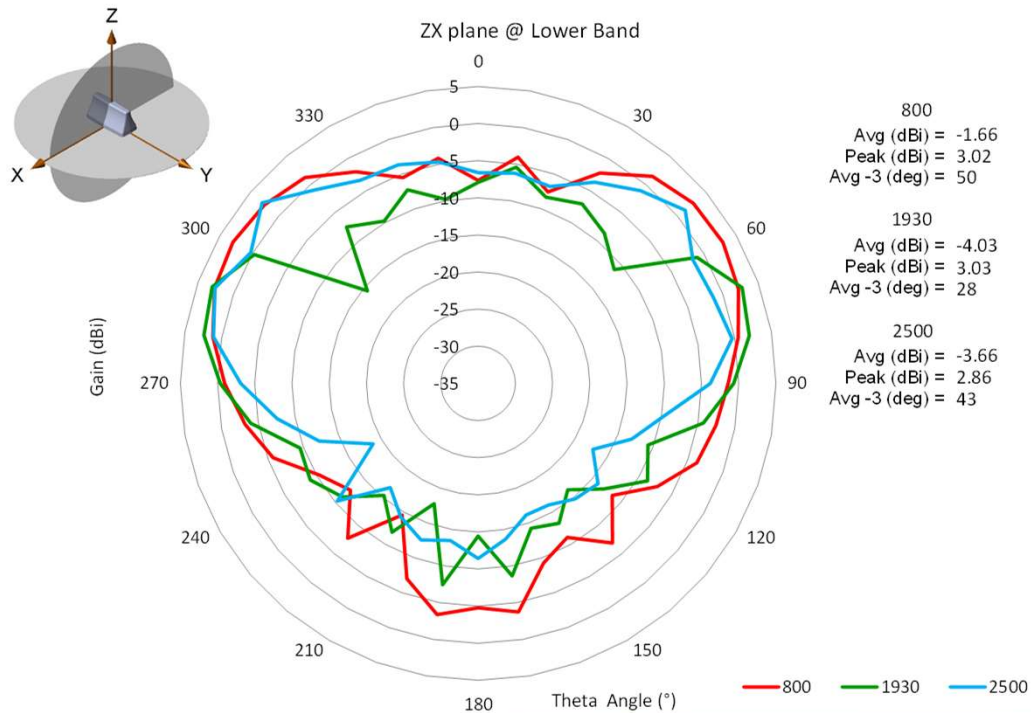

Issue: 1742

In the effort to improve our products, we reserve the right to make changes judged to be necessary.

CONFIDENTIAL AND PROPRIETARY INFORMATION

This document contains confidential and proprietary information of Pulse Electronics, Inc. (Pulse) and is protected by copyright, trade secret and other state and federal laws. Its receipt or possession does not convey any rights to reproduce, disclose its contents, or to manufacture, use or sell anything it may describe. Reproduction, disclosure or use without specific written authorization of Pulse is strictly forbidden.

Series: RAZORBACK

PART NUMBER: RAZ32011MM, RAZ32012MM, RAZ42111MM,
RAZ42112MM, RAZ52211MM, RAZ52212MM, RAZ62311MM, RAZ62312MM

CHARTS

Peak Gain vs Frequency
RAZ62311MM Measured with 3ft cables on Ø40" GP (WiFi 1)
Measured at Pulse, USA - July 07, 2017

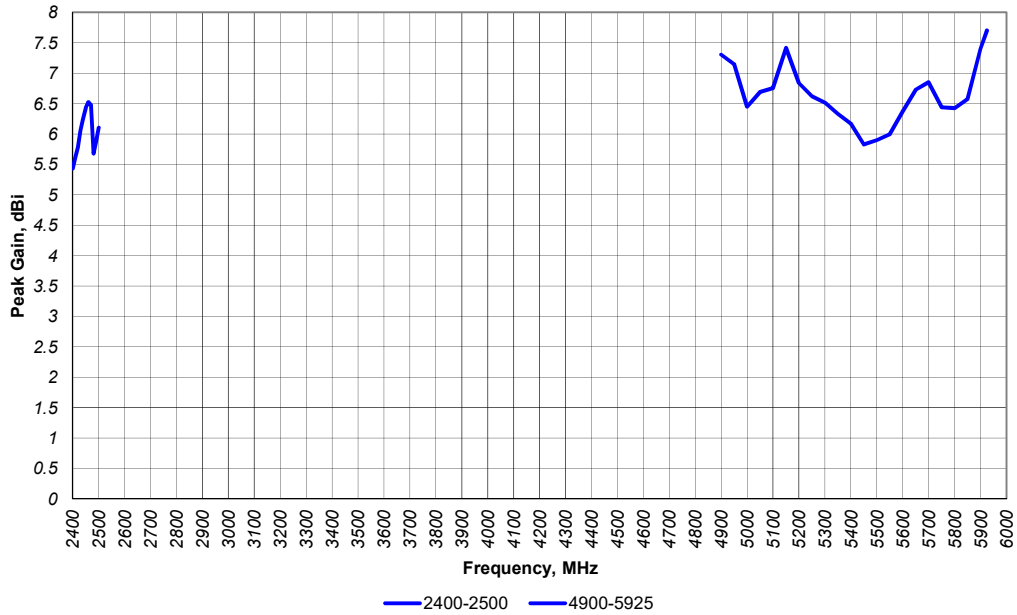

WiFi 1
Measured with
914mm (36") cable

Efficiency vs Frequency
RAZ62311MM Measured with 3ft cables on Ø40" GP (WiFi 1)
Measured at Pulse, USA - July 07, 2017

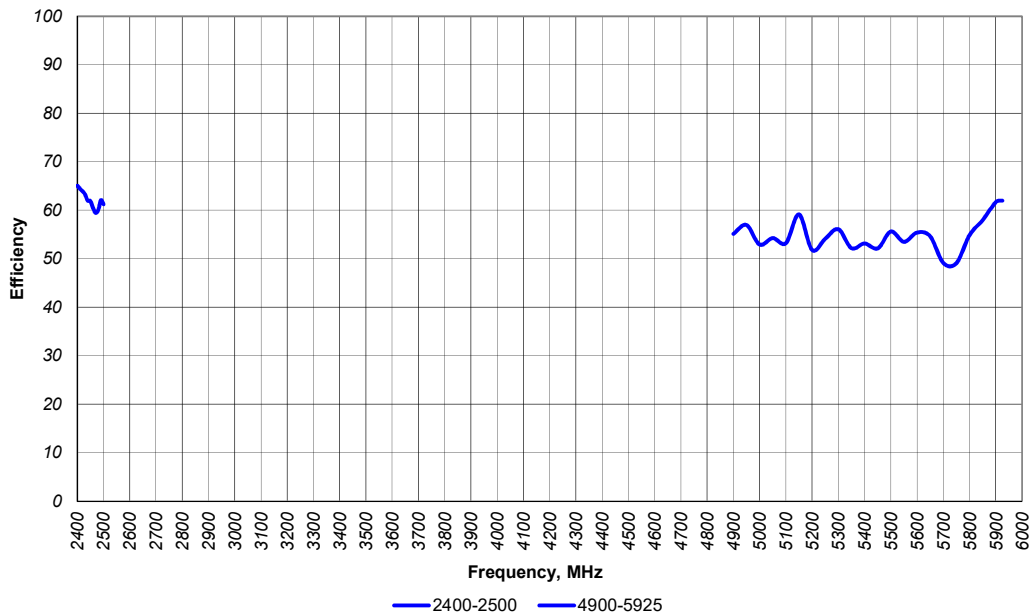

WiFi 1
Measured with
914mm (36") cable

Issue: 1742

In the effort to improve our products, we reserve the right to make changes judged to be necessary.

CONFIDENTIAL AND PROPRIETARY INFORMATION

This document contains confidential and proprietary information of Pulse Electronics, Inc. (Pulse) and is protected by copyright, trade secret and other state and federal laws. Its receipt or possession does not convey any rights to reproduce, disclose its contents, or to manufacture, use or sell anything it may describe. Reproduction, disclosure or use without specific written authorization of Pulse is strictly forbidden.

Series: RAZORBACK

PART NUMBER: RAZ32011MM, RAZ32012MM, RAZ42111MM,
RAZ42112MM, RAZ52211MM, RAZ52212MM, RAZ62311MM, RAZ62312MM

CHARTS

WiFi 1

Measured with
914mm (36") cable

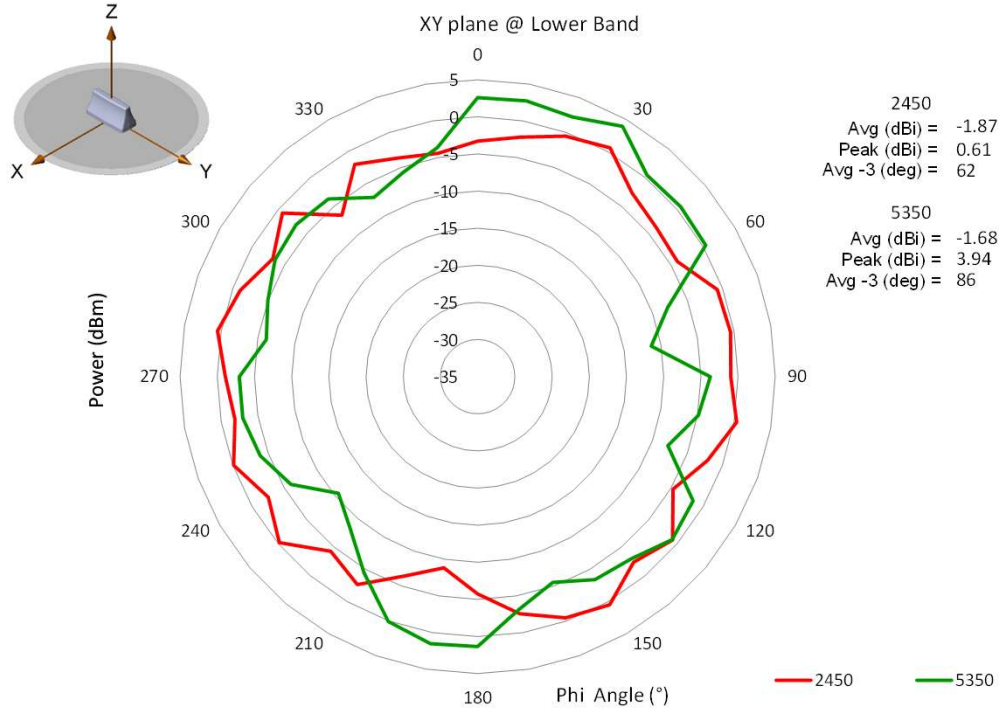

WiFi 1

Measured with
914mm (36") cable

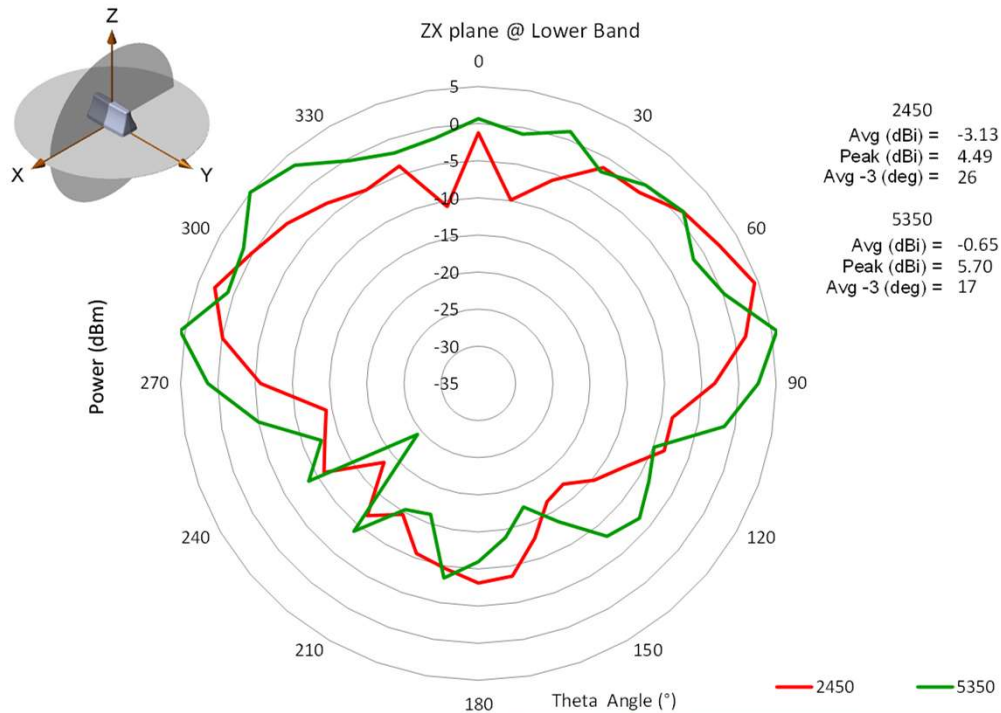

Issue: 1742

In the effort to improve our products, we reserve the right to make changes judged to be necessary.

CONFIDENTIAL AND PROPRIETARY INFORMATION

This document contains confidential and proprietary information of Pulse Electronics, Inc. (Pulse) and is protected by copyright, trade secret and other state and federal laws. Its receipt or possession does not convey any rights to reproduce, disclose its contents, or to manufacture, use or sell anything it may describe. Reproduction, disclosure or use without specific written authorization of Pulse is strictly forbidden.

Series: RAZORBACK

PART NUMBER: RAZ32011MM, RAZ32012MM, RAZ42111MM,
RAZ42112MM, RAZ52211MM, RAZ52212MM, RAZ62311MM, RAZ62312MM

CHARTS

Peak Gain vs Frequency
RAZ62311MM Measured with 3ft cables on Ø40" GP (WiFi 2)
Measured at Pulse, USA - July 07, 2017

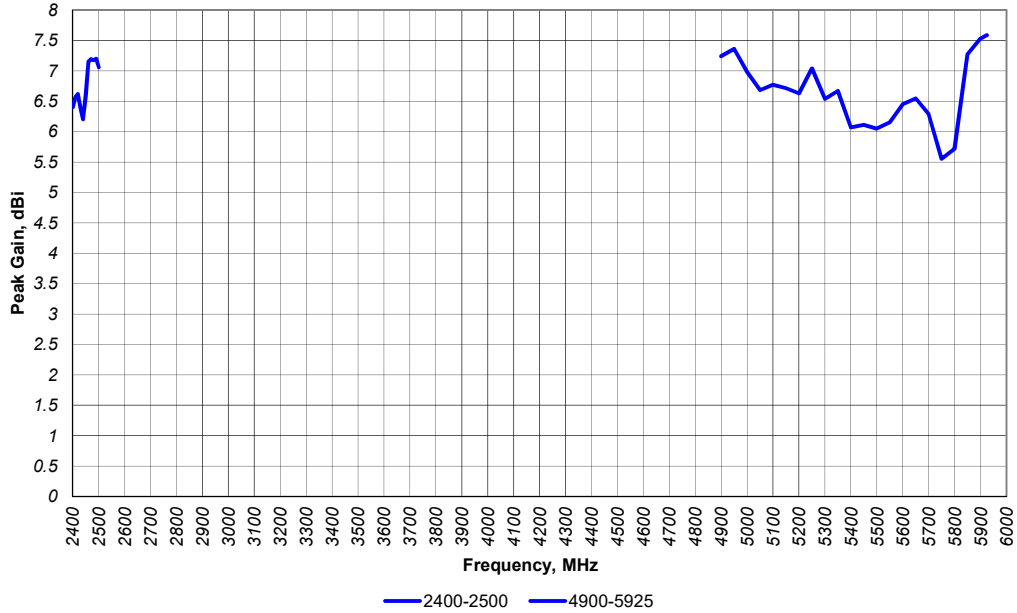

WiFi 2
Measured with
914mm (36") cable

Efficiency vs Frequency
RAZ62311MM Measured with 3ft cables on Ø40" GP (WiFi 2)
Measured at Pulse, USA - July 07, 2017

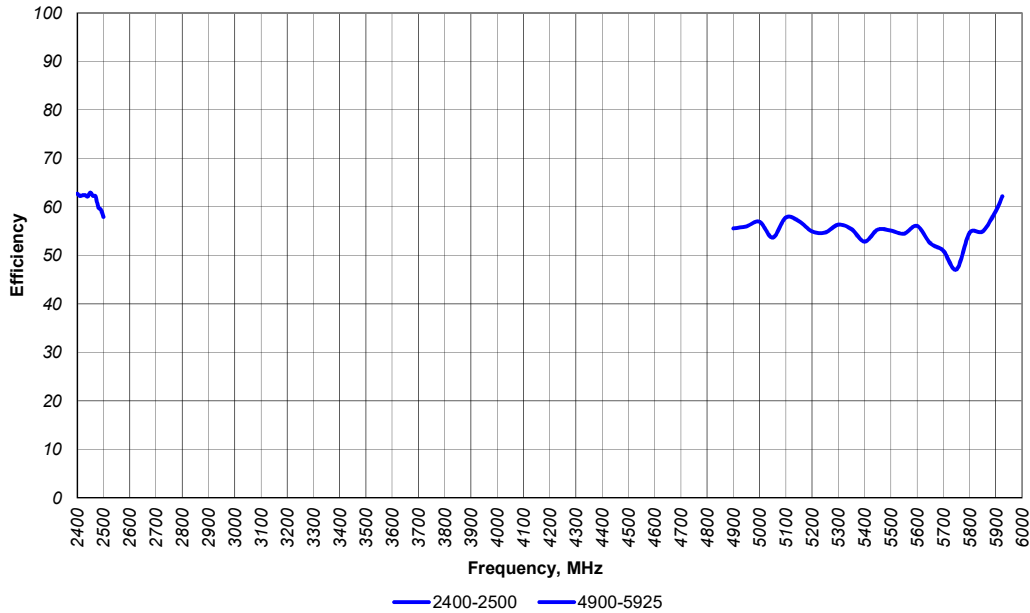

WiFi 2
Measured with
914mm (36") cable

Issue: 1742

In the effort to improve our products, we reserve the right to make changes judged to be necessary.

CONFIDENTIAL AND PROPRIETARY INFORMATION

This document contains confidential and proprietary information of Pulse Electronics, Inc. (Pulse) and is protected by copyright, trade secret and other state and federal laws. Its receipt or possession does not convey any rights to reproduce, disclose its contents, or to manufacture, use or sell anything it may describe. Reproduction, disclosure or use without specific written authorization of Pulse is strictly forbidden.

Series: RAZORBACK

PART NUMBER: RAZ32011MM, RAZ32012MM, RAZ42111MM,
RAZ42112MM, RAZ52211MM, RAZ52212MM, RAZ62311MM, RAZ62312MM

CHARTS

WiFi 2
Measured with
914mm (36") cable

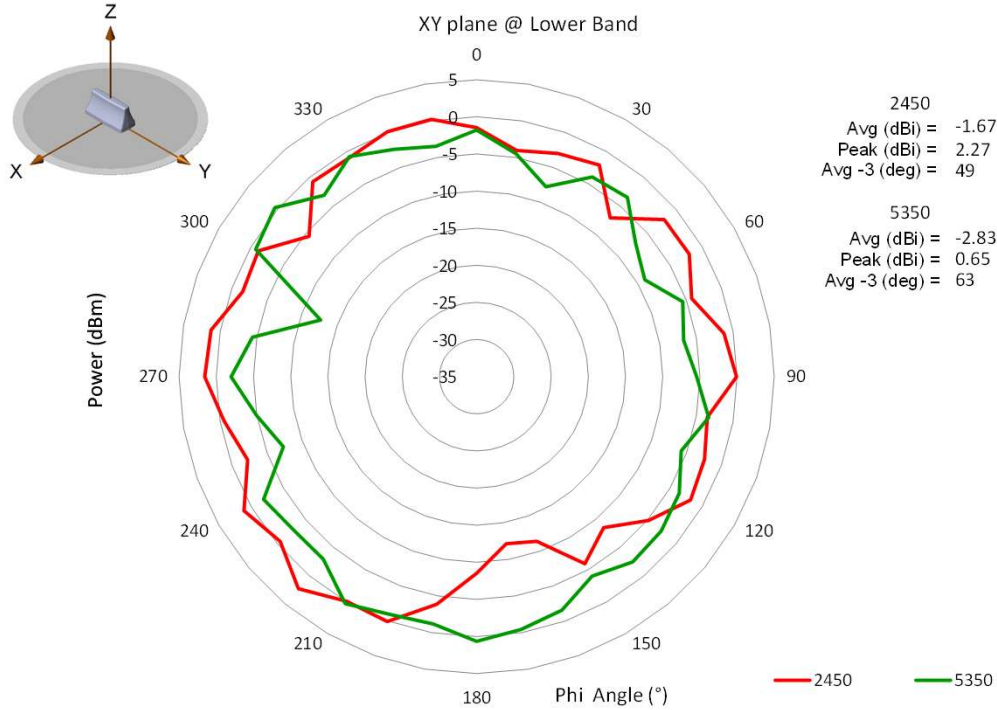

WiFi 2
Measured with
914mm (36") cable

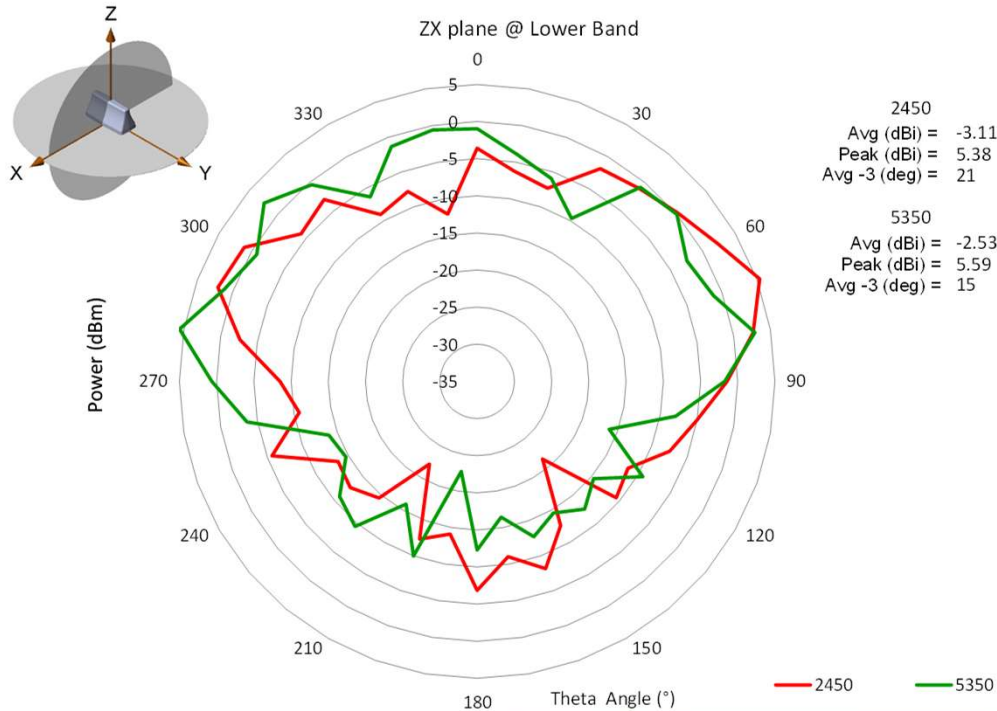

Issue: 1742

In the effort to improve our products, we reserve the right to make changes judged to be necessary.

CONFIDENTIAL AND PROPRIETARY INFORMATION

This document contains confidential and proprietary information of Pulse Electronics, Inc. (Pulse) and is protected by copyright, trade secret and other state and federal laws. Its receipt or possession does not convey any rights to reproduce, disclose its contents, or to manufacture, use or sell anything it may describe. Reproduction, disclosure or use without specific written authorization of Pulse is strictly forbidden.

Series: RAZORBACK

PART NUMBER: RAZ32011MM, RAZ32012MM, RAZ42111MM,
RAZ42112MM, RAZ52211MM, RAZ52212MM, RAZ62311MM, RAZ62312MM

CHARTS

Peak Gain vs Frequency
RAZ62311MM Measured with 3ft cables on Ø40" GP (WiFi 3)
Measured at Pulse, USA - July 07, 2017

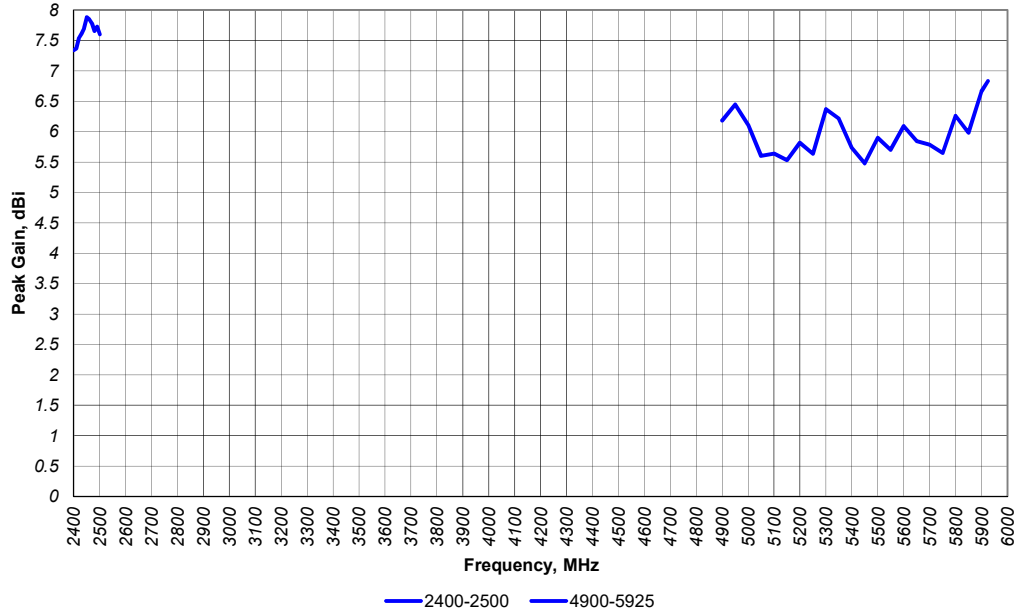

WiFi 3
Measured with
914mm (36") cable

Efficiency vs Frequency
RAZ62311MM Measured with 3ft cables on Ø40" GP (WiFi 3)
Measured at Pulse, USA - July 07, 2017

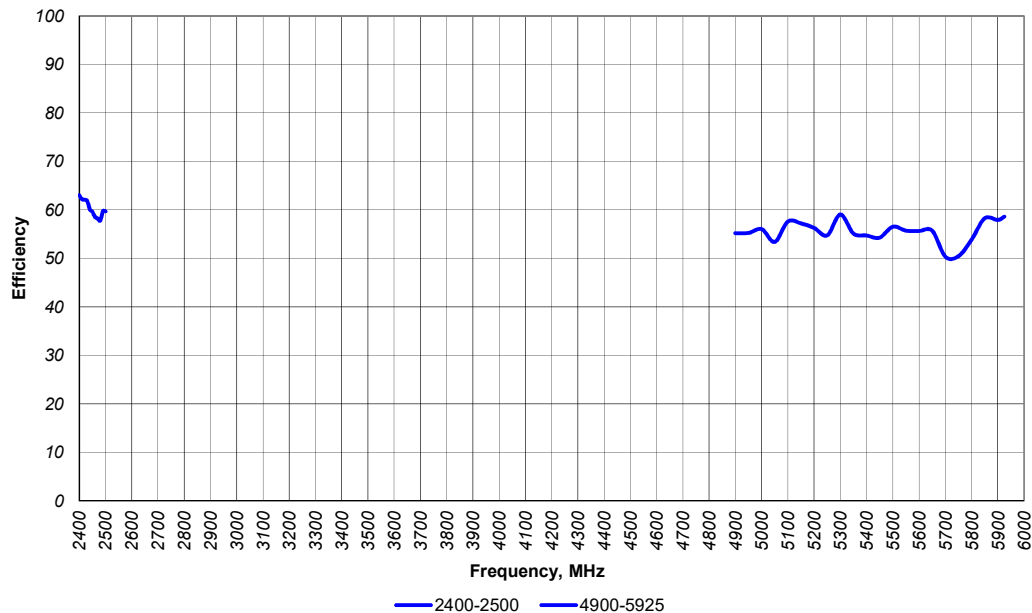

WiFi 3
Measured with
914mm (36") cable

Issue: 1742

In the effort to improve our products, we reserve the right to make changes judged to be necessary.

CONFIDENTIAL AND PROPRIETARY INFORMATION

This document contains confidential and proprietary information of Pulse Electronics, Inc. (Pulse) and is protected by copyright, trade secret and other state and federal laws. Its receipt or possession does not convey any rights to reproduce, disclose its contents, or to manufacture, use or sell anything it may describe. Reproduction, disclosure or use without specific written authorization of Pulse is strictly forbidden.

Series: RAZORBACK

PART NUMBER: RAZ32011MM, RAZ32012MM, RAZ42111MM,
RAZ42112MM, RAZ52211MM, RAZ52212MM, RAZ62311MM, RAZ62312MM

CHARTS

WiFi 3
Measured with
914mm (36") cable

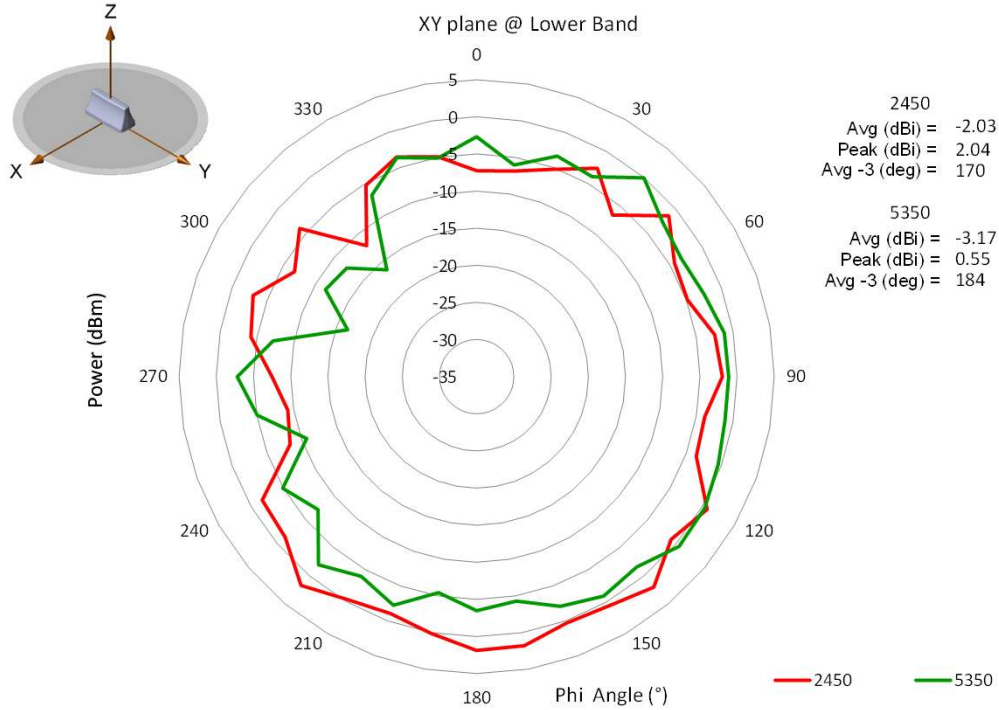

WiFi 3
Measured with
914mm (36") cable

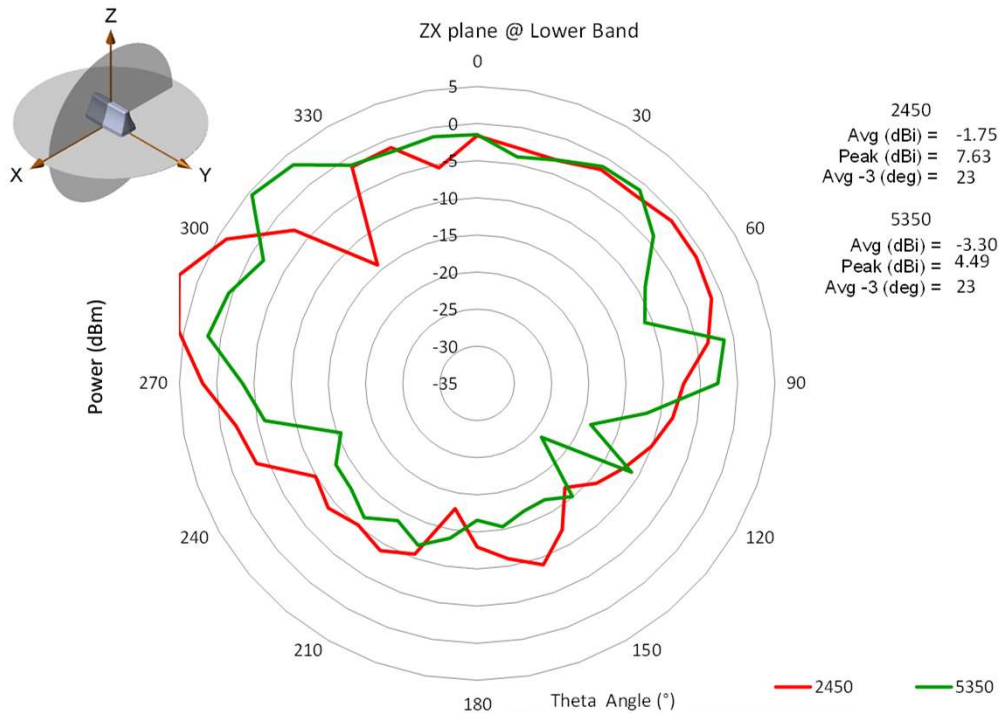

Issue: 1742

In the effort to improve our products, we reserve the right to make changes judged to be necessary.

CONFIDENTIAL AND PROPRIETARY INFORMATION

This document contains confidential and proprietary information of Pulse Electronics, Inc. (Pulse) and is protected by copyright, trade secret and other state and federal laws. Its receipt or possession does not convey any rights to reproduce, disclose its contents, or to manufacture, use or sell anything it may describe. Reproduction, disclosure or use without specific written authorization of Pulse is strictly forbidden.

Series: RAZORBACK

PART NUMBER: RAZ32011MM, RAZ32012MM, RAZ42111MM,
RAZ42112MM, RAZ52211MM, RAZ52212MM, RAZ62311MM, RAZ62312MM

CHARTS

GNSS LNA Gain and out-of-band rejection

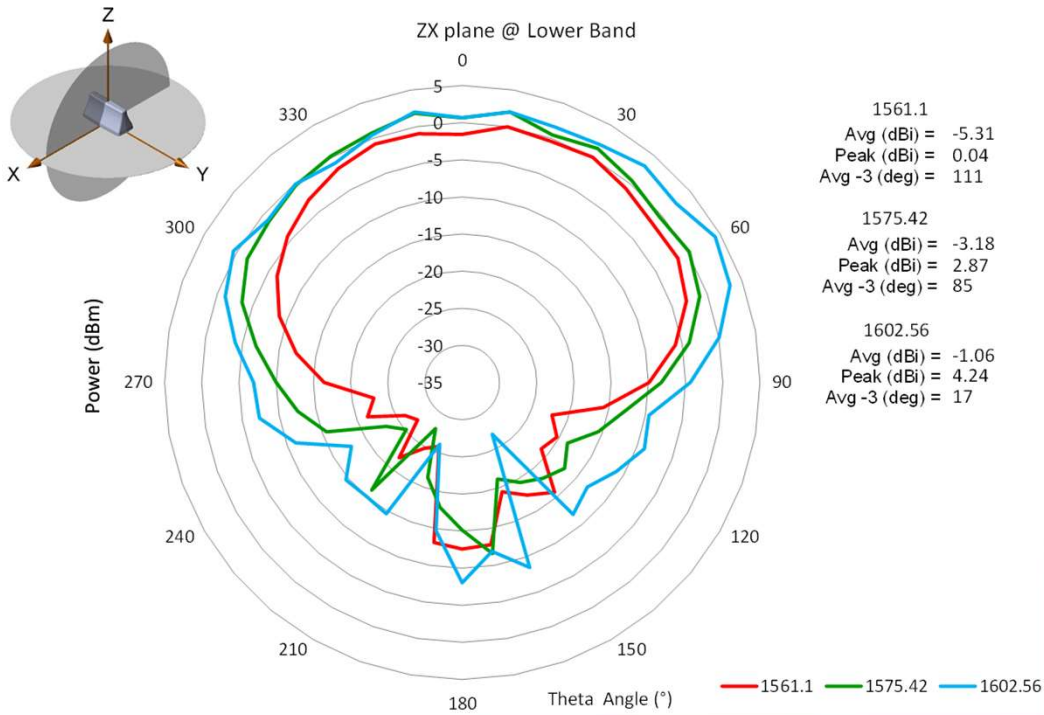
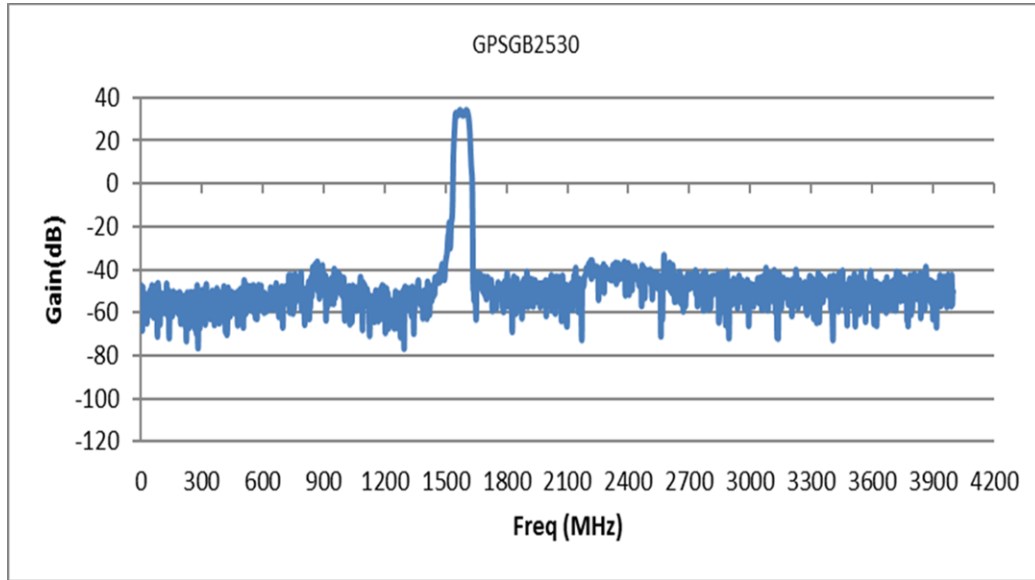

GNSS

Passive Measurement
Measured with 152mm (6") cable

Issue: 1742

In the effort to improve our products, we reserve the right to make changes judged to be necessary.

CONFIDENTIAL AND PROPRIETARY INFORMATION

This document contains confidential and proprietary information of Pulse Electronics, Inc. (Pulse) and is protected by copyright, trade secret and other state and federal laws. Its receipt or possession does not convey any rights to reproduce, disclose its contents, or to manufacture, use or sell anything it may describe. Reproduction, disclosure or use without specific written authorization of Pulse is strictly forbidden.

Description: GNSS / 2x LTE / 0, 1x, 2x or 3x WiFi
Magnetic Mount

Series: RAZORBACK

PART NUMBER: RAZ32011MM, RAZ32012MM, RAZ42111MM,
RAZ42112MM, RAZ52211MM, RAZ52212MM, RAZ62311MM, RAZ62312MM

PACKAGING

1pcs antennas per foam bag

6pcs antennas per package box

Total 6pcs antenna per package box

Package box: 558mm*386mm*210mm